

1" Bore Miniature Brass Cylinders

Miniature Brass Cylinders

Double acting in two popular mounting styles... fixed clevis and nose mount. Available with double rod. For 150 PSI maximum air and 300 PSI maximum hydraulic service. Their heavy brass construction makes these compact cylinders compatible with the most demanding applications. Bore size 1".

DOUBLE ACTING NECK MOUNTING

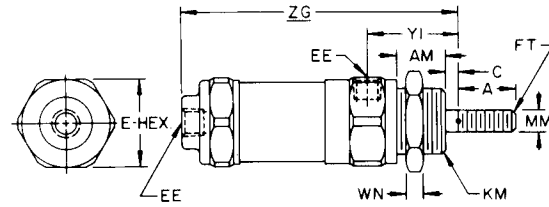
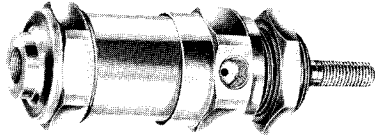

CYL. STROKE	1"	2"	3"	4"	6"	9"	12"
AIR MODEL NO.	30901-0010	30901-0020	30901-0030	30901-0040	30901-0060	30901-0090	30901-0120
HYDRAULIC MODEL	40901-0010	40901-0020	40901-0030	40901-0040	40901-0060	40901-0090	40901-0120

	A	C	E	AM	EE N.P.T.	FT	KM	MM	WN	Y1	ZG
in.	.75	.31	1.31	.69	1/8-27	5/16-24	1-14	.31	.25	1.41	2.88
mm	19.0	7.9	33.3	17.5	—	—	—	7.9	6.4	35.8	73.2

DOUBLE ACTING FIXED EYE MOUNTING

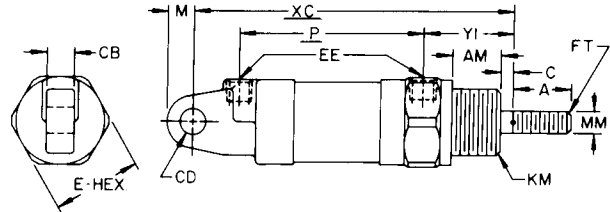
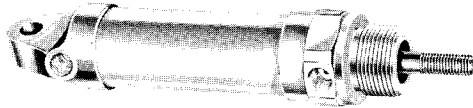

CYL. STROKE	1"	2"	3"	4"	6"	9"	12"
AIR MODEL NO.	30911-0010	30911-0020	30911-0030	30911-0040	30911-0060	30911-0090	30911-0120
HYDRAULIC MODEL	40911-0010	40911-0020	40911-0030	40911-0040	40911-0060	40911-0090	40911-0120

	A	C	E	M	P	AM	CB	CD	EE N.P.T.	FT	KM	MM	Y1	XC
in.	.75	.31	1.31	.38	1.38	.69	.50	.38	1/8-27	5/16-24	1-14	.31	1.41	3.50
mm	19.0	7.9	33.3	9.7	35.1	17.5	12.7	9.7	—	—	—	7.9	35.8	88.9

DOUBLE ACTING DOUBLE ROD NECK MOUNTING

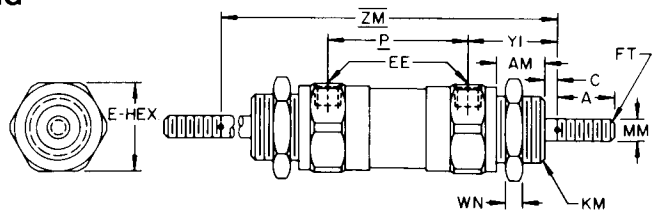
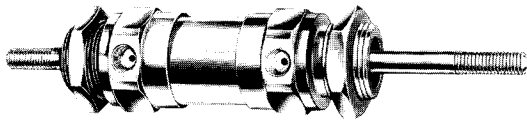

CYL. STROKE	1"	2"	3"	4"	6"	9"	12"
AIR MODEL NO.	30901-0010	30901-0020	30901-0030	30901-0040	30901-0060	30901-0090	30901-0120
HYDRAULIC MODEL	45901-0010	45901-0020	45901-0030	45901-0040	45901-0060	45901-0090	45901-0120

	A	C	E	P	AM	EE N.P.T.	FT	KM	MM	WN	Y1	ZM
in.	.75	.31	1.31	1.38	.69	1/8-27	5/16-24	1-14	.31	.25	1.41	4.19
mm	19.0	7.9	33.3	35.1	17.5	—	—	—	7.9	6.4	35.8	106.4

NOTES: ADD STROKE LENGTH TO ALL UNDER-LINED DIMENSIONS

TWO TIMES STROKE MUST BE ADDED TO DIMENSIONS WITH A LINE UNDER AND ABOVE LETTERS

1" Bore Miniature Brass Cylinders

Accessories

ROD EYE

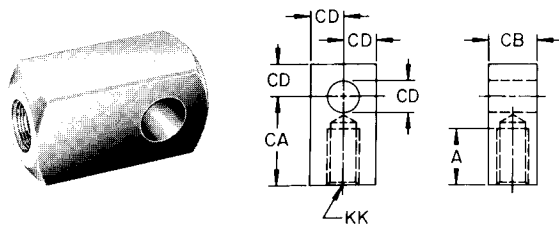

PART NO.		KK	A	CA	CB	CD
05160-0050	in.	5/16-24	.75	1.50	.50	.38
	mm	—	19.0	38.1	12.7	9.7

ROD CLEVIS WITH CLEVIS PIN AND JAM NUT

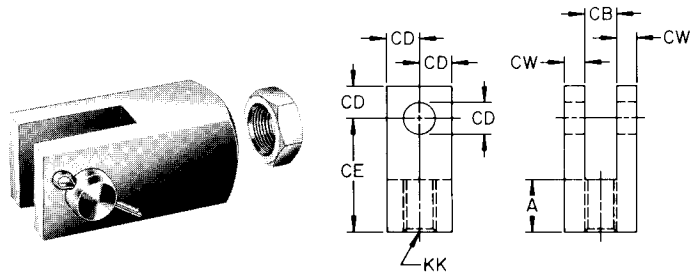

PART NO.		KK	A	CB	CD	CE	CW
05300-0103	in.	5/16-24	.75	.50	.38	1.38	.25
	mm	—	19.0	12.7	9.7	35.1	6.4

FORGED ROD CLEVIS WITH CLEVIS PIN AND JAM NUT

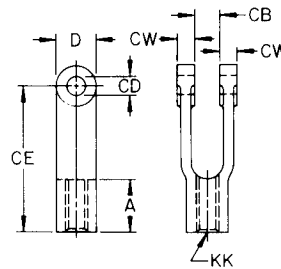
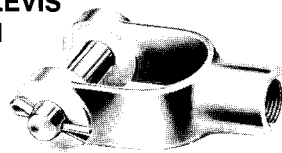

PART NO.		KK	A	D	CB	CD	CE	CW
30097-9000	in.	5/16-24	.81	.50	.31	.31	2.25	.22
	mm	—	20.6	12.7	7.9	7.9	57.2	5.6

MOUNTING ACCESSORIES

ANGLE BRACKET

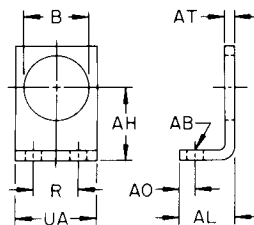
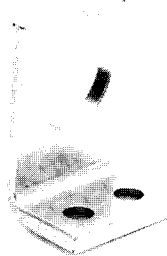

PART NO.		B	R	AB	AH	AL	AO	AT	UA
30901-9500	in.	1.00	.62	.28	1.12	1.00	.31	.17	1.31
	mm	25.4	15.7	7.1	28.5	25.4	7.9	4.3	33.3

CLEVIS BRACKET

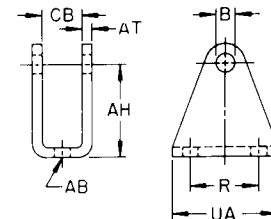
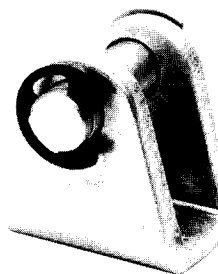

PART NO.		B	R	AB	AH	AT	CB	UA
30911-9500	in.	.38	.62	.28	1.00	.19	.52	1.25
	mm	9.7	15.7	7.1	25.4	4.8	13.2	31.8

1" Bore Miniature Brass Cylinders

Parts

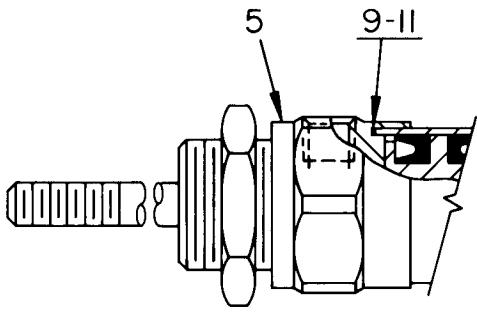

DOUBLE ACTING DOUBLE ROD NECK MOUNTING

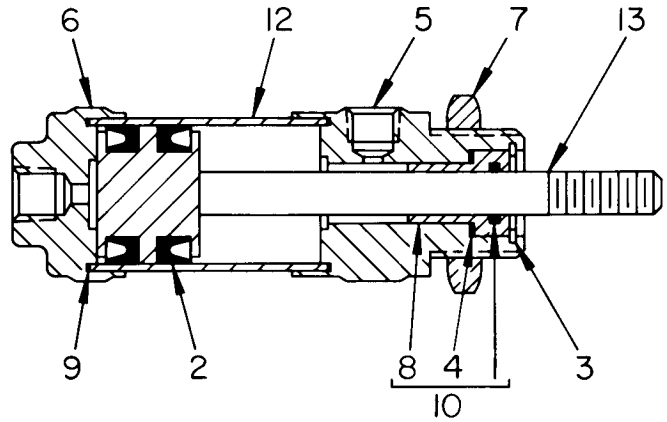

DOUBLE ACTING NECK MOUNTING

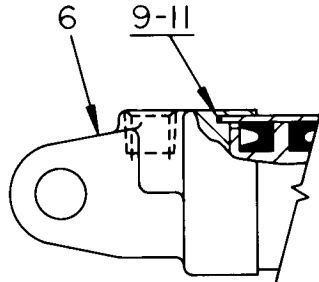

DOUBLE ACTING FIXED CLEVIS MOUNTING

1" DIA. BORE 5/16" DIA. PISTON ROD

ITEM NO.	DESCRIPTION	PART NUMBERS		
		NECK MOUNT	FIXED CLEVIS	NECK MOUNT DOUBLE ENDED
● 1	O-Ring-Air	—	—	—
1a	V-Seal Hydraulic	—	—	—
● 2	Piston Cup (2)	—	—	—
* 3	Retaining Ring	03368-0062	03368-0062	03368-0062
● 4	O-Ring	—	—	—
5	Head	30901-7001	3091-7001	3091-7001
6	Cap	30901-7002	30901-7002	—
* 7	Nut	30901-7003	—	30901-7003
* 8	Bearing-Air	30901-7004	30901-7004	30901-7004
8a	Bearing-Hydraulic	30901-7007	30901-7007	30901-7007
● 9	Gasket (2)	—	—	—
* 10	Bearing Assy. -Air	30901-8000	30901-8000	30901-8000
10a	Bearing Assy. -Hydraulic	40901-8000	40901-8000	40901-8000
■ ● 11	Gasket	—	—	—
▲ 12	Cylinder Tube	50029-0028	50029-0028	50029-0028
▲ 13	Piston & Rod Assy.	50031-0067	50031-0067	**50129-0123
	Service Kits-Air	30901-8001	30901-8001	30901-8001
	Service Kits-Hydraulic	40901-8001	40901-8001	45901-8001

▲ - Part numbers listed are for 1" Stroke. For each additional inch of stroke add - 0016 to the basic number.

** - For Double End Piston. Rod Assembly for each additional inch of stroke add .0032 to the basic number.

■ - Use as Needed to Align Ports.

* - Double quan. for Double Ended Cylinders.

● - Parts included in Service Kit.

EXAMPLE: 50031 - 0067 = 1" Stroke

- 0016 = 2" Stroke

50031 - 0083 = 2" Stroke

CAUTION:

If it is possible that the ambient temperature may fall below freezing the medium must be moisture free to prevent internal damage or unpredictable behavior.

For additional information – call your local
Schrader Bellows Distributor.

**Schrader
Bellows®**