



HY13-1512-006-M1/US

# Torqmotor™ Service Procedure

Effective: March 2007

---



TC, TS, TB, TE, TJ, TF,  
TG, TH and TL Series  
Low Speed, High Torque  
Hydraulic Torqmotors™

---



**WARNING**

FAILURE OR IMPROPER SELECTION OR IMPROPER USE OF THE PRODUCTS AND/OR SYSTEMS DESCRIBED HEREIN OR RELATED ITEMS CAN CAUSE DEATH, PERSONAL INJURY AND PROPERTY DAMAGE.

This document and other information from Parker Hannifin Corporation, its subsidiaries and authorized distributors provide product and/or system options for further investigation by users having technical expertise. It is important that you analyze all aspects of your application and review the information concerning the product or system in the current product catalog. Due to the variety of operating conditions and applications for these products or systems, the user, through its own analysis and testing, is solely responsible for making the final selection of the products and systems and assuring that all performance, safety and warning requirements of the application are met.

The products described herein, including without limitation, product features, specifications, designs, availability and pricing, are subject to change by Parker Hannifin Corporation and its subsidiaries at any time without notice.

**Offer of Sale**

The items described in this document are hereby offered for sale by Parker Hannifin Corporation, its subsidiaries or its authorized distributors. This offer and its acceptance are governed by the provisions stated in the "Offer of Sale".

© Copyright 2007, 2006, 2005, 2000, 1999, Parker Hannifin Corporation, All Rights Reserved

Definitions.....	3
Design Features .....	4 - 5
Introduction .....	7
Troubleshooting Guide .....	8
Troubleshooting Checklist .....	9
Tools and Material Required for Servicing.....	10
Bolt Torque .....	11
Exploded Assembly View .....	12-14
TC Service Parts List Chart .....	15-16
TS Service Parts List Chart .....	17
TB Service Parts List Chart .....	18-19
TE Service Parts List Chart .....	20-21
TJ Service Parts List Chart.....	22
TF Service Parts List Chart.....	23-24
TG Service Parts List Chart.....	25-26
TH Service Parts List Chart.....	27-28
TL Service Parts List Chart.....	29
Disassembly & Inspection .....	30-37
Torqmotor™ Assembly.....	38-47
Rotor Set Component Assembly Procedure (One Piece Stator).....	48
Rotor Set Component Assembly Procedure (Two Piece Stator).....	49-50
Final Checks.....	51
Hydraulic Fluids, Filtration, Oil Temperature .....	51
Tips for Maintaining the System.....	52
Offer of Sale .....	Inside Back Cover

## Definitions

**NOTE:** A NOTE provides key information to make a procedure easier or quicker to complete.

**CAUTION:** A CAUTION refers to procedure that must be followed to avoid damaging the Torqmotor™ or other system components.

**WARNING:** A WARNING REFERS TO PROCEDURE THAT MUST BE FOLLOWED FOR THE SAFETY OF THE EQUIPMENT OPERATOR AND THE PERSON INSPECTING OR REPAIRING THE TORQMOTOR™.

## Disclaimer

This Service Manual has been prepared by Parker Hannifin for reference and use by mechanics who have been trained to repair and service hydraulic motors and systems on commercial and non-commercial equipment applications. Parker Hannifin has exercised reasonable care and diligence to present accurate, clear and complete information and instructions regarding the techniques and tools required for maintaining, repairing and servicing the complete line of Parker TC, TS, TB, TE, TJ, TF, TG, TH and TL Torqmotor™ Units. However, despite the care and effort taken in preparing this general Service Manual, Parker **makes no warranties** that (a) the Service Manual or any explanations, illustrations, information, techniques or tools described herein are either accurate, complete or correct as applied to a specific Torqmotor™ unit, or (b) any repairs or service of a particular Torqmotor™ unit will result in a properly functioning Torqmotor™ unit.

If inspection or testing reveals evidence of abnormal wear or damage to the Torqmotor™ unit or if you encounter circumstances not covered in the Manual, STOP – CONSULT THE EQUIPMENT MANUFACTURER’S SERVICE MANUAL AND WARRANTY. DO NOT TRY TO REPAIR OR SERVICE A TORQMOTOR™ UNIT WHICH HAS BEEN DAMAGED OR INCLUDES ANY PART THAT SHOWS EXCESSIVE WEAR UNLESS THE DAMAGED AND WORN PARTS ARE REPLACED WITH ORIGINAL PARKER REPLACEMENT AND SERVICE PARTS AND THE UNIT IS RESTORED TO PARKER SPECIFICATIONS FOR THE TORQMOTOR™ UNIT.

It is the responsibility of the mechanic performing the maintenance, repairs or service on a particular Torqmotor™ unit to (a) inspect the unit for abnormal wear and damage, (b) choose a repair procedure which will not endanger his/her safety, the safety of others, the equipment, or the safe operation of the Torqmotor™, and (c) fully inspect and test the Torqmotor™ unit and the hydraulic system to insure that the repair or service of the Torqmotor™ unit has been properly performed and that the Torqmotor™ and hydraulic system will function properly.

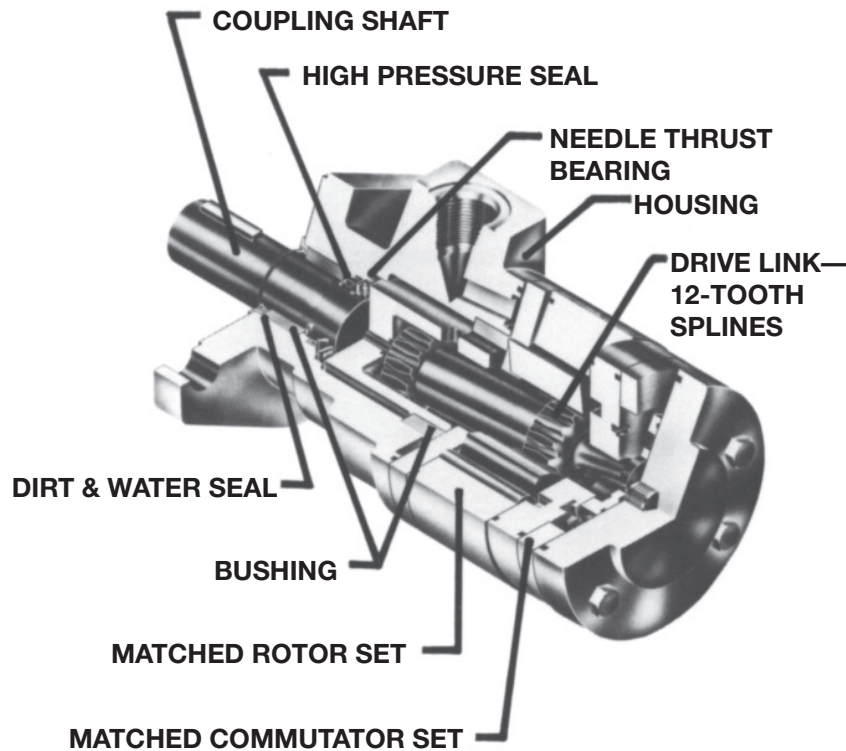

#### Torqmotor™ TB/TC Series features include:

- The roller vane rotor set design offers a low-friction, wear compensation which maximizes the useful performance life of the motor.
- Zero leak **commutation valve provides greater, more consistent volumetric efficiency.**
- Design flexibility - TB offers the widest selection of shaft options, displacements and mounting flanges in the industry.
- Patented 60-40 spline member arrangement transmits more torque with less weight.
- Full flow lubrication maximizes cooling and may provide up to 50% longer life than motors not having this feature.
- Higher pressure rating provide greater torque than competitive brands.
- Full interchangeability with other motors which are designed according to industry standards.
- Compatible with most hydraulic systems with regard to pressure, torque and speed.
- A unique high-pressure shaft seal that eliminates the need for case drains.
- Up to 13 horsepower output.

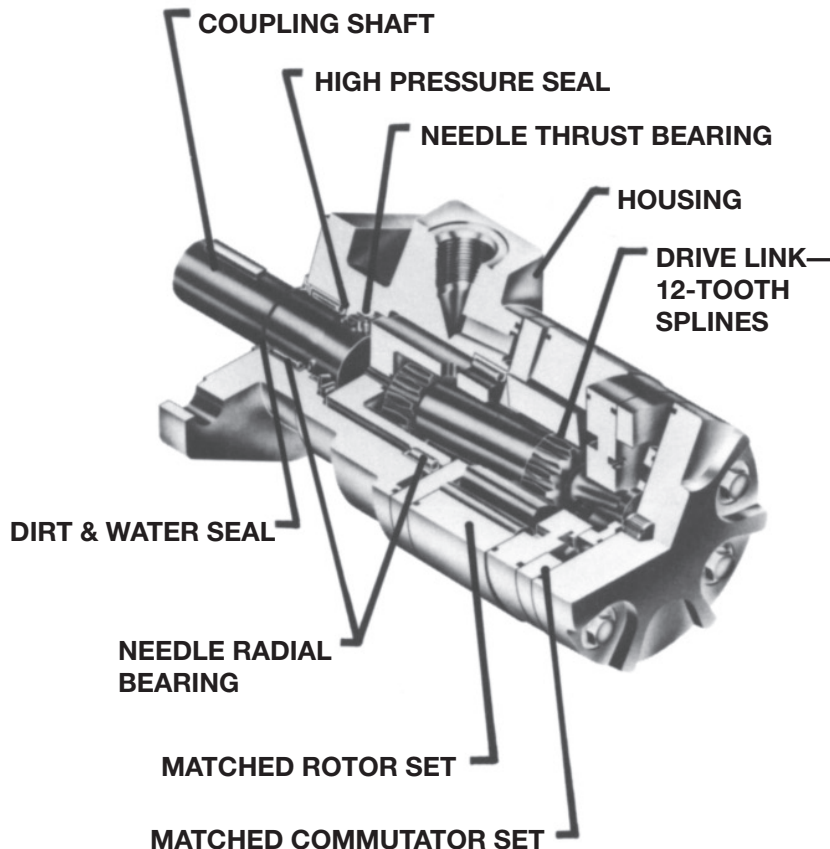

#### Torqmotor™ TE Series features include:

- Roller vanes to reduce friction and internal leakage and to maintain efficiency.
- Zero leak **commutation valve provides greater, more consistent volumetric efficiency.**
- Wheel mount version available.
- More starting torque than competitive motors in applications where the shaft is side loaded. (Competitive brands require more pressure to start the motor.)
- A needle-roller mounted coupling shaft and steel-caged thrust bearing which can withstand 1000-pound thrust loads.
- Side load capacity is 1600 lbs. (727.3 kg) maximum at center of output shaft.
- A unique high-pressure shaft seal that eliminates the need for case drains, check valves and extra plumbing.
- Up to 17 horsepower output.
- Greater durability due to superior lubrication and minimum drive spline wear.
- Patented 60-40 spline member arrangement transmits more torque with less weight.

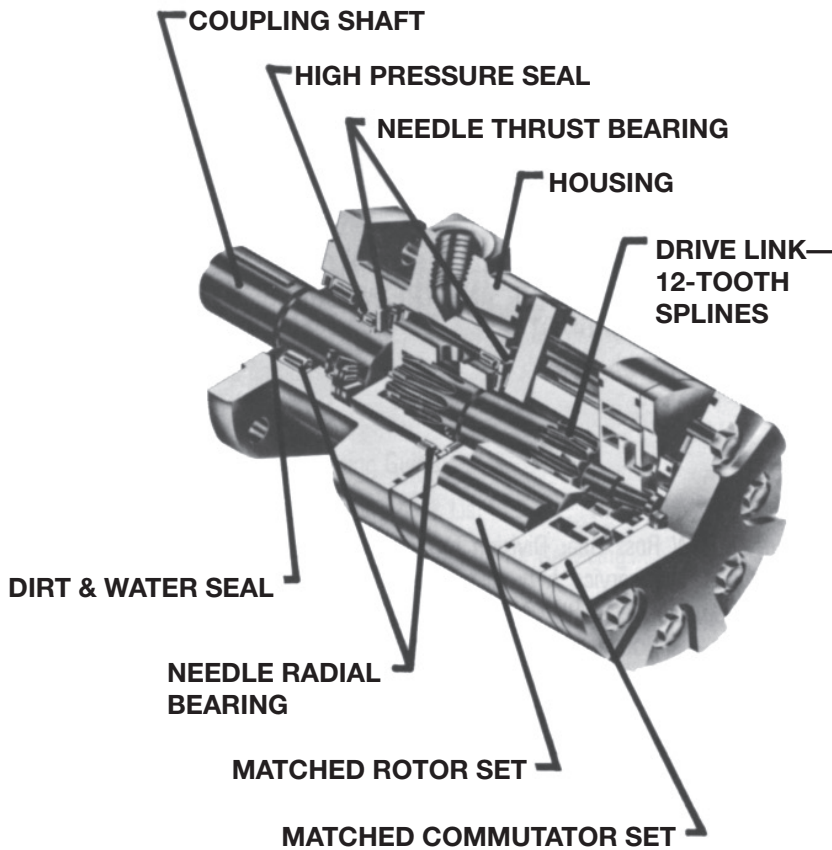

**Torqmotor™ TF Series features include:**

- Heavy-duty thrust and roller bearings for up to twice side-load capacity to the previous motor.
- Roller vanes to reduce friction and internal leakage, and to maintain efficiency.
- A patented orbiting commutation system for less wear and longer life.
- A patented 60:40 arrangement of internal and external spline members to transmit more torque with less weight.
- A unique high-pressure shaft seal that eliminates the need for case drains, check valves and extra plumbing.
- A unique manifold designed to improve operating efficiency.
- Up to 1000 lbs. (453.6 kg) end-thrust capacity in either direction.
- A design that is less sensitive to contamination than competitive motors.
- Up to 36 horsepower output.
- Greater durability because of superior lubrication and minimum drive spline wear.
- Superior low speed performance.
- Zero leak **commutation valve provides greater, more consistent volumetric efficiency.**

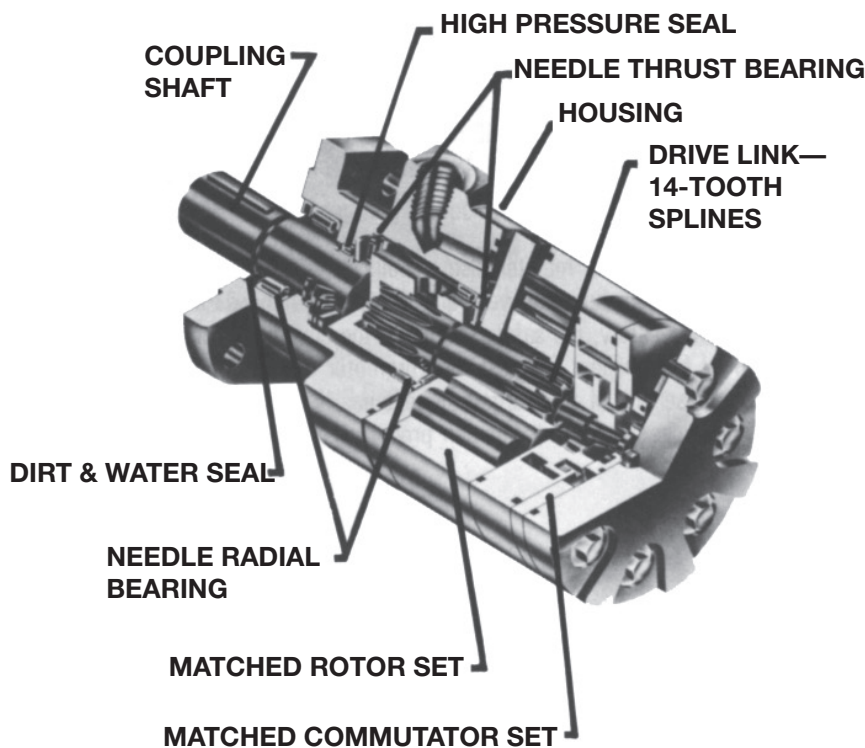

**Torqmotor™ TG/ TH/TL Series features include:**

- Roller vanes to reduce friction and internal leakage and to maintain efficiency.
- A patented orbiting commutation system for less wear and longer life.
- A patented 60:40 arrangement of internal and external spline members to transmit more torque with less weight.
- A unique high-pressure shaft seal that eliminates the need for case drains, check valves and extra plumbing.
- A manifold designed to improve operating efficiency.
- Heavy-duty thrust and roller bearings for up to twice the side-load capacity to the previous motor.
- Up to 1000 lbs. (453.6 kg) end-thrust capacity in either direction.
- A design that is less sensitive to contamination than competitive motors.
- Up to 49 horsepower output.
- Greater durability because of superior lubrication and minimum drive spline wear.
- Zero leak **commutation valve provides greater, more consistent volumetric efficiency.**

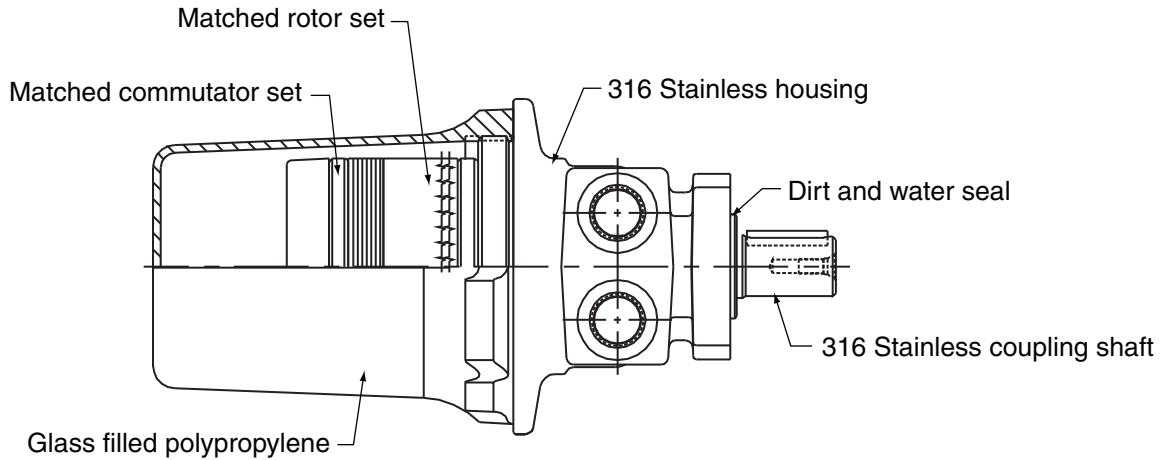

### Torqmotor™ TS Series features include:

- The roller vane rotor set design offers a low-friction, wear compensation which maximizes the useful performance life of the motor.
- Zero leak commutation valve provides greater, more consistent volumetric efficiency.
- Design flexibility—TS offers the 316 stainless steel housing and shaft with a one-size-fits-all displacements polypropylene cover.
- Patented 60-40 spline member arrangement transmits more torque with less weight.
- Full flow lubrication maximizes cooling and may provide up to 50% longer life than motors not having this feature.
- Higher pressure rating provides greater torque than competitive brands.
- Full interchangeability with other motors which are designed according to industry standards.
- Compatible with most hydraulic systems with regard to pressure, torque and speed.
- A unique high-pressure shaft weal that eliminates the need for case drains.
- Up to 13 horsepower output.

## Introduction

This service manual has one purpose: to guide you in maintaining, troubleshooting, and servicing the TC, TS, TB, TE, TJ, TF, TG, TH and TL Torqmotor™ (low-speed, high-torque hydraulic motor).

Material in this manual is organized so you can work on the Torqmotor™ and get results without wasting time or being confused. To get these results, you should read this entire manual before you begin any work on the Torqmotor™.

This manual also contains troubleshooting information and checklist. If you must service the Torqmotor™, the checklist will help you to determine where the problem may be.

The three-column format of the Disassembly and Inspection, and Assembly sections will make it easier for you to conduct major work on the Torqmotor™. Column 1 gives a brief key for each procedure. Column 2 explains in detail the procedure you should follow. Column 3 illustrates this procedure with photographs. Read all material carefully and pay special attention to the notes, cautions, and warnings.

A page with the Torqmotor™ exploded assembly view is provided several places in this manual. The component part names and item numbers assigned on this exploded assembly view correspond with names and item numbers (in parentheses) used in the disassembly and assembly procedures set forth in this manual. Service part list charts are also provided in this manual with the part names and exploded view item numbers cross referenced to Parker service part numbers.

Service parts are available through the Original Equipment Manufacturer or Parker approved TC, TS, TB, TE, TJ, TF, TG, TH and TL Distributors.

As you gain experience in servicing the Torqmotor™, you may find that some information in this manual could be clearer or more complete. If so, let us know about it. Do not try to second guess the manual. If you are stuck, contact us. Servicing the Torqmotor™ should be a safe and productive procedure, in order for the unit to deliver the reliable, long-life operation engineered into it.

NOTE: Before troubleshooting any system problem, check service literature published by the equipment and/or component manufacturers. Follow their instructions, if given, for checking any component other than the Torqmotor™ unit.

## Preparation

Make your troubleshooting easier by preparing as follows:

- work in a clean, well-lighted place;
- have proper tools and materials nearby;
- have an adequate supply of clean petroleum-based solvent.

WARNING: SINCE SOLVENTS ARE FLAMMABLE, BE EXTREMELY CAREFUL WHEN USING ANY SOLVENT, EVEN A SMALL EXPLOSION OR FIRE COULD CAUSE INJURY OR DEATH.

WARNING: WEAR EYE PROTECTION AND BE SURE TO COMPLY WITH OSHA AND OTHER MAXIMUM AIR PRESSURE REQUIREMENTS.

## Preliminary Checks

Hydraulic systems are often trouble-free. Hence, the problem an operator complains of could be caused by something other than the hydraulic components.

Thus, once you have determined that a problem exists, start with the easy-to-check items, such as:

- parts damaged from impact that were not properly repaired, or that should have been replaced; and
- improper replacement parts used in previous servicing
- mechanical linkage problems such as binding, broken, or loose parts or slipping belts

## Hydraulic Components

If you think the problem is caused by a hydraulic component, start by checking the easy-to-reach items.

Check all hoses and lines for cracks, hardening, or other signs of wear. Reroute any usable hoses that are kinked, severely bent, or that rest against hot engine parts. Look for leaks, especially at couplings and fittings. Replace any hoses or lines that don't meet system flow and pressure ratings.

Next, go to the reservoir and filter or filters. Check fluid level and look for air bubbles. Check the filter(s). A filter with a maximum 50 micron filtration is recommended for the Torqmotor™ system.

Visually check other components to see if they are loosely mounted, show signs of leaks, or other damage or wear.

Excessive heat in a hydraulic system can create problems that can easily be overlooked. Every system has its limitation for the maximum amount of temperature. After the temperature is attained and passed, the following can occur:

- oil seal leaks
- loss of efficiency such as speed and torque
- pump loss of efficiency
- pump failure
- hoses become hard and brittle
- hose failure

A normal temperature range means an efficient hydraulic system. Consult the manuals published by equipment and/or component manufacturers for maximum allowable temperature and hydraulic tests that may be necessary to run on the performance of the hydraulic components. The Torqmotor™ is not recommended for hydraulic systems with maximum temperatures above 200°F (93.3°C).



Trouble	Cause	Remedy
<b>Oil Leakage</b>	1. Hose fittings loose, worn or damaged.	Check & replace damaged fittings or “O” Rings. Torque to manufacturers specifications.
	2. Oil seal rings (4) deteriorated by excess heat.	Replace oil seal rings by disassembling Torqmotor™ unit.
	3. Special bolt (1, 1A, 1B or 1C) loose or its sealing area deteriorated by corrosion.	(a) Loosen then tighten single bolt to torque specification. (b) Replace bolt.
	4. Internal shaft seal (16) worn or damaged.	Replace seal. Disassembly of Torqmotor™ unit necessary.
	5. Worn coupling shaft (12) and internal seal (16).	Replace coupling shaft and seal by disassembling Torqmotor™ unit.
<b>Significant loss of speed under load</b>	1. Lack of sufficient oil supply	(a) Check for faulty relief valve and adjust or replace as required. (b) Check for and repair worn pump. (c) Check for and use correct oil for temperature of operation.
	2. High internal motor leakage	Replace worn rotor set by disassembling Torqmotor™ unit.
	3. Severely worn or damaged internal splines.	Replace rotor set, drive link and coupling shaft by disassembling Torqmotor™ unit.
	4. Excessive heat.	Locate excessive heat source (usually a restriction) in the system and correct the condition.
<b>Low mechanical efficiency or undue high pressure required to operate Torqmotor™ unit</b>	1. Line blockage	Locate blockage source and repair or replace.
	2. Internal interference	Disassemble Torqmotor™ unit, identify and remedy cause and repair, replacing parts as necessary.
	3. Lack of pumping pressure	Check for and repair worn pump.
	4. Excessive binding or loading in system external to Torqmotor™ unit.	Locate source and eliminate cause.

**CAUTION:** If the hydraulic system fluid becomes overheated [in excess of 200°F (93.3°C)], seals in the system can shrink, harden or crack, thus losing their sealing ability.

- Clean, petroleum-based solvent
- Emery paper
- Vise with soft jaws
- Air pressure source
- Arbor press
- Screw driver
- Masking tape
- Breaker bar
- Torque wrench-ft. lbs. (N m)
- Sockets: 1/2 or 9/16 inch thin wall, 1 inch
- Allen Sockets: 3/16, 3/8 inch
- Adjustable crescent wrench or hose fitting wrenches
- SAE 10W40 SE or SF oil
- Special bearing mandrel for TC, TB & TE Torqmotors (SEE FIGURE 1)
- Special bearing mandrel for TH Torqmotors (consult factory)
- Special bearing mandrel for TF, TG & TJ Torqmotors (SEE FIGURE 2)
- Feeler gage .005 inch (.13 mm)
- TC, TB & TE Torqmotors require blind hole bearing puller for 1.06 inch (26.9) mm) and 1.62 inch (41.1 mm) diameter bearing/bushing.
- TH Torqmotors require blind hole bearing puller for a 1.575 inch dia. (40.0 mm) and 2.130 inch dia. (54.1 mm) bearings.
- TJ, TF, TG & TL Torqmotors require blind hole bearing puller for 1.400 inch dia. (35.6 mm) and 2.130 inch dia. (54.1 mm) bearings.
- Clean corrosion resistant grease. Part #406018 is included in each seal kit. Recommended grease is Parker Specification #045236 or Mobil Mobilith SHC® 460

**NOTE: The available service seal kits include the recommended grease as a grease pack #406018**

**CAUTION: Mixing greases that have different bases can be detrimental to bearing life.**

**CONVERSIONS**

INCHES	mm	INCHES	mm
.020	.51	1.060	26.92
.021	.53	1.295	32.89
.029	.74	1.297	32.94
.030	.76	1.396	35.46
.111	2.81	1.398	35.51
.119	3.02	1.620	41.15
.152	3.86	1.622	41.20
.160	4.06	1.983	50.37
.296	7.52	1.985	50.42
.304	7.72	2.120	53.85
.460	11.68	2.122	53.90
.470	11.94	2.233	56.72
.500	12.70	2.235	56.77
.585	14.86	2.483	63.07
.595	15.11	2.485	63.12
.660	16.76	2.500	63.5
.675	17.15	2.88	73.2
1.058	26.87		

**Torque Chart**

Part Name	Item Number	Torque
bolt 5/16 24 UNF 2A	1, 1A, 1B or 1C	25-30 ft. lbs. (33-40 N m)
bolt 3/8 24 UNF 2A	1, 1A, 1B or 1C	45-55 ft. lbs. (60-76 N m)
bolt 5/8 18 UNF 2A	12D	140-180 ft. lbs. (190-244 N m)
nut 3/4 16 UNF 2B	12B (TC, TB, TE)	175-255 ft. lbs. (237-305 N m)
nut 1-20 UNEF 2B	12B (TF, TG, TL)	300-400 ft. lbs. (407-542 N m)
nut 1-1/8 18 UNEF 2B	12B (TG, TH)	300-400 ft. lbs. (407-542 N m)

- TC has two steel bushing internal of housing press first steel bushing 1.223 deep from housing face the second steel bushing press .03 below face
- TL press internal bearing .576 below face
- TH press internal bearing .120 below face

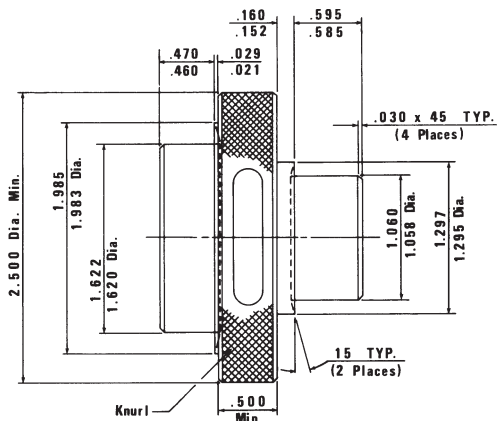

(Fabricate if considered necessary)

Figure 1 – TC, TB & TE

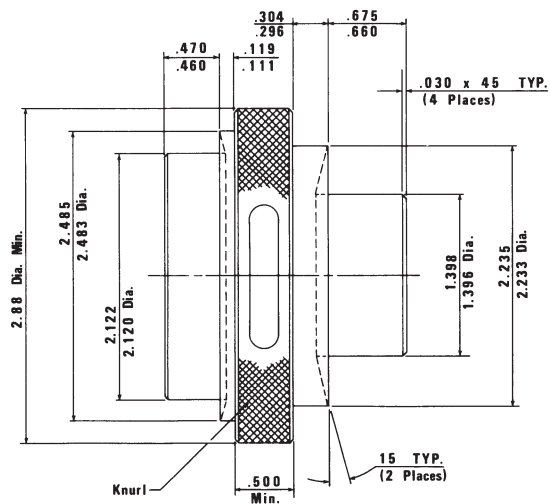

(Fabricate if considered necessary)

Figure 2 – TF & TG (see note)

Typical Assembly

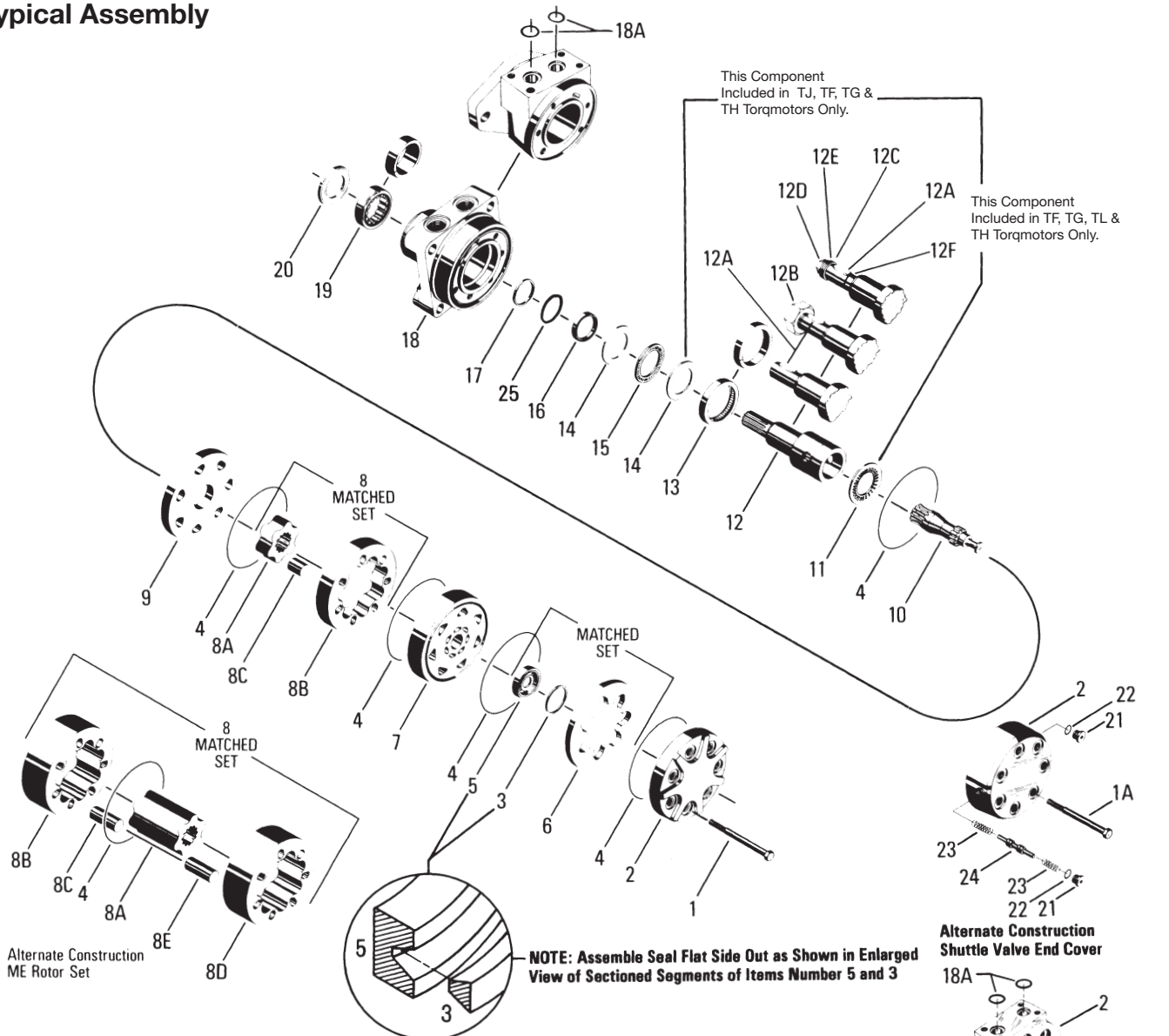

Item

No. Description

- |                               |                            |                               |
|-------------------------------|----------------------------|-------------------------------|
| 1. Special Bolts (5, 6, or 7) | 9. Wear Plate              | 18. Housing                   |
| 1a. Special Bolts (7)         | 10. Drive Link             | 18a. O-Ring (2)               |
| 1b. Special Bolts (7)         | 11. Thrust Bearing         | 19. Bearing/Bushing, Outer    |
| 1c. Special Bolts (7)         | 12. Coupling Shaft         | 20. Dirt & Water Seal         |
| 2. End Cover                  | 12a. Key                   | 21. Plug (2)                  |
| 3. Seal Ring-Commutator       | 12b. Nut                   | 22. O-Ring (2)                |
| 4. Seal Ring (5)              | 12c. Washer                | 23. Spring                    |
| 5. Commutator                 | 12d. Bolt                  | 24. Valve (Shuttle or Relief) |
| 6. Commutator Ring            | 12e. Lockwasher            | 25. Backup Washer             |
| 7. Manifold                   | 12f. Retaining Ring        |                               |
| 8. Rotor Set                  | 13. Bearing/Bushing, Inner |                               |
| 8a. Rotor                     | 14. Thrust Washer          |                               |
| 8b. Stator or Stator Half     | 15. Thrust Bearing         |                               |
| 8c. Vane (7)                  | 16. Seal                   |                               |
| 8d. Stator Half               | 17. Backup Ring            |                               |
| 8e. Vane (7)                  |                            |                               |

 = Items not sold separately. Sold as matched sets only.

TS Series Assembly

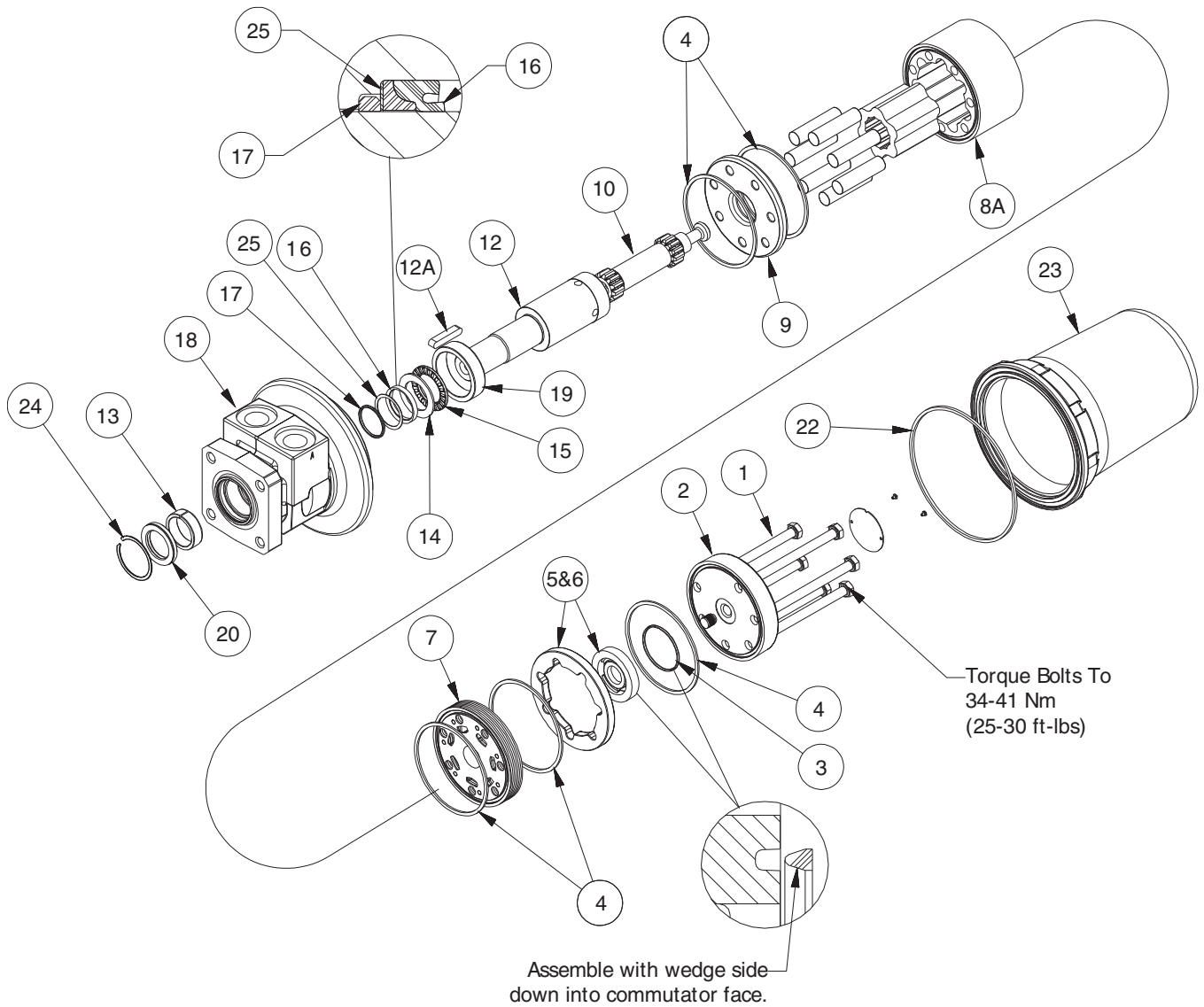

**Typical Assembly**

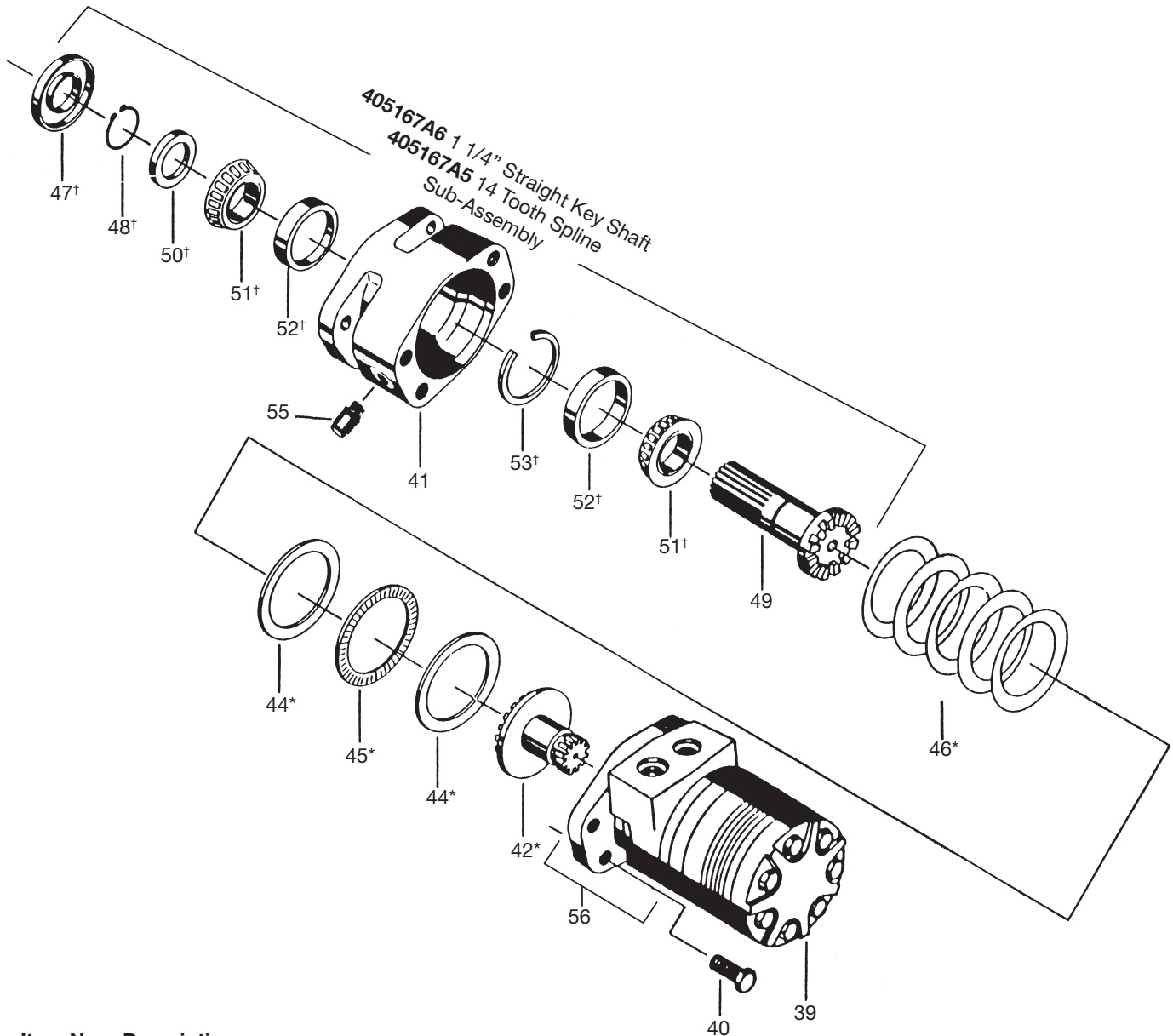

Item No.	Description	
39	Torqmotor Sub-Assembly	
40	Bolt 1/2-13 (UNC-2A) (4 Req'd.)	021479
41	Clutch Housing	405167
42*	Splined Gear Drive	490102
44*	Thrust Washer (2)	400142
45*	Thrust Bearing	073005
46*	Disc Spring (5)	028511
47†	Seal - Dirt and Water	478035
48†	Snap Ring	401622
49	Drive Shaft 14 Tooth Spline	093043
49	Straight Key Shaft 1 1/4"	093044
50†	Thrust Washer	400141
51†	Bearing and Cone Assembly (2)	067033
52†	Bearing Cup (2)	400140
53†	Retaining Ring	401623
55	Plug	036024
56	Housing	ME012013A1

NOTE: Apply .06 in. (1.5 mm) Bead of Loctite #51514 Around Full Circumference of Pilot

\* Items sold separately: not included in Seal Kit

† SK000039 for Clutch Assembly only

SK000092 Seal Kit for Hydraulic Motor only Item #39.

Clutch Motor applies to TF Series only (Not available in 22, 25, 29 cu in.)

SHC Oil 90 WT 45± 5CC

**TC Service Parts List Chart**

Torqmotor™ Service Procedure

**TC, TS, TB, TE, TJ, TF, TG, TH and TL Series**

**Chart Use Example:**

TC0045AS010AAAB Torqmotor™ includes part numbers listed to the right of TC (SERIES), 0045 (DISP.), AS (MOUNTING/PORTING), 01(SHAFT), 0 (ROTATION), and AAAB (OPTION) shown in the left hand column of the chart.

**Caution:**

The charted component service information is for the Torqmotors listed only. Refer to the original equipment manufacturer of the equipment using the Torqmotor for assembly numbers not listed below.

SERIES	EXPLODED VIEW										
	ITEM #	5 & 6	7	9	<sup>A</sup> 13	14	15	17	<sup>A</sup> 19	20	25
	DESCRIPTION	COMMUTATOR & RING ASSY	MANIFOLD (SEE NOTE)	WEAR PLATE	STEEL BUSHING	THRUST WASHER	THRUST BEARING	BACKUP WASHER	STEEL BUSHING	DIRT & WATER SEAL	BACKUP WASHER
TC-	Service Part #	MF018000A1	MF015000	477341	069511	028483	065066	028516	069511*	478036	028552

(\*quantity 2)

DISPLACEMENT GROUP	EXPLODED VIEW				ROTOR				
	ITEM #	1	or 1A	or 1C	THICKNESS	8A	8B	10	"L" Dim
	DISPLACEMENT (in <sup>3</sup> /rev)	BOLT (5)	BOLT (5)	BOLT (5)	"L" DIM OF ROTOR THICKNESS	ROTOR SET	FREE RUNNING ROTOR SET <sup>††</sup>	DRIVE LINK	Overall Length
	0036- 2.2	021356				.2750	MF017003	MF017005	MF013000
0045- 2.7	021311	021433	021308		.3169	MF027003	MF027005	MF023000	3.021
0050- 3.0	021311	021444	021308		.3751	MF037003	MF037005	MF033000	3.080
0065- 4.0	021306	021358	021435		.5001	MF047003	MF047005	MF043000	3.206
0080- 5.0	021382	021438	021359		.6258	MF057003	MF057005	MF053000	3.334
0100- 6.0	021357	021308	021445		.7508	MF067003	MF067005	MF063000	3.460
0130- 8.0	021307	021359	021439		1.0008	MF087003	MF087005	MF083000	3.712
0165- 9.9	021358	021310	*		1.2508	MF107003	MF107005	MF103000	3.969
0195- 11.9	021308	021383	021465		1.5008	MF127003	MF127005	MF123000	4.215
0230- 13.9	021359	021384	021460		1.7508	MF147003	MF147005	MF143000	4.467
0260- 15.9	021310	021466	021467		2.0008	MF167003	MF167005	MF163000	4.718
0295- 17.9	021383	021414	*		2.2508	MF187003	MF187005	MF183000	4.970
0330- 20.0	021384	021459	021448		2.5008	MF207003	MF207005	MF203000	5.220
0365- 22.6	021460	021448	*		2.8406	MF227003	N/A	MF223000	5.557
0390- 24.0	021414	021449	021464		3.0030	MF247003	N/A	MF243000	5.716

<sup>††</sup> Free running rotorset is not available in 0365 or 0390 Displacements.

\* Not released.

TC has two steel bushing press internal of housing.

HOUSING GROUP	Mounting Code Porting Code	EXPLODED VIEW				
		ITEM #	2	<sup>1,2</sup> 18	<sup>A</sup> 18A	
		DESCRIPTION	END COVER	HOUSING SERVICE PART #	O-RING (2)	
FRONT PORTING	AT-	SAE A (2 Bolt)	1/2" BSPF	MF016000	ML012012A1	
	AS-	SAE A (2 Bolt)	7/8" O-Ring	MF016000	ML012001A1	
	FS-	4 Bolt	7/8" O-Ring	MF016000	ML012005A1	
	AM-	SAE A (2 Bolt)	Manifold	MF016000	ML012008A1	032790
	FM-	4 Bolt	Manifold	MF016000	ML012006A1	032790
	AP-	SAE A (2 Bolt)	1/2" NPTF	MF016000	ML012002A1	
	FP-	4 Bolt	1/2" NPTF	MF016000	ML012007A1	
	FF-	4 Bolt	3/4" O-Ring	MF016000	ML012013A1	



EXPLODED VIEW		12	12A	12B
ITEM #	DESCRIPTION	COUPLING SHAFT	WOODRUFF KEY	NUT
COUPLING SHAFT GROUP	01- Long 6B Snapwire Groove	ML019010		
	09- 1" Ø, 0.38 Pinhole, 0.55" from end	ML019005		
	10- 1" Short Woodruff Key 1/4" Tap	ML019002	038015 (1/4x1)	
	11- 1" Short 6B Spline, 1/4" Snapwire Groove	ML019001		
	13- 1" Long Woodruff Snapwire Groove	ML019006	038015 (1/4x1)	
	15- 1" Ø, 0.32 Pinhole 0.4" from end	ML019011		
	21- "-10 Code" plus Corrosion Resistant	ML019008		
	26- 25 mm Straight with 8 mm Keyway	ML019003	039047	
	28- 13 Tooth Spline	ML019007		
	72- Short Woodruff Key 1/4" Tap	ML019009		

EXPLODED VIEW		2	3	4	16	21	22	23	24	
ITEM #	DESCRIPTION	BOLTS (5)	END COVER	COMMUTATOR SEAL	SEAL RING (5)	INNER SEAL	PLUG & O-RING ASSY	O-RING	SPRING	VALVE W/SPRING
AAAB	No Paint	Item #1		032435	032821	032377				
AAAC	Corrosion Resistant Paint	Item #1		032435	032821	032377				
AAAH	Fluorocarbon Seals	Item #1		032435	032822	032809				
BBC	1740 PSI Internal Bidirectional Relief, No Paint	Item #1C	MF016006A7	032435	032821	032377	036297	032750	401660	4100107
BBCM	1200 PSI Internal Bidirectional Relief, No Paint	Item #1C	MF016006A31	032435	032821	032377	036297	032750	401660	41001031
BBCN	2030 PSI Internal Bidirectional Relief, No Paint	Item #1C	MF016006A5	032435	032821	032377	036297	032750	401660	4100105
BBCP	1450 PSI Internal Bidirectional Relief, No Paint	Item #1C	MF016006A10	032435	032821	032377	036297	032750	401660	41001010
BBC	1560 PSI Internal Bidirectional Relief, No Paint	Item #1C	MF016006A2	032435	032821	032377	036297	032750	401660	4100102
BBCP	1450 PSI Internal Bidirectional Relief, No Paint	Item #1C	MF016006A10	032435	032821	032377	036297	032750	401660	41001010
AAJV	Bidirectional Shuttle Valve (3:30), Black Paint	Item #1A	MF016003A1	032435	032821	032377	036297	032750	401660	415603
AABW	Fluorocarbon Seal, Double Paint	Item #1	MF016000	032435	032821	032377				
AAAG	Fluorocarbon Seals, Black Paint	Item #1	MF016000	032435	032821	032377				
AABJ	Free Running Rotor Set, Black Paint	Item #1	MF016000	032435	032821	032377				
AABK	Free Running Rotor Set, No Paint	Item #1	MF016000	032435	032821	032377				

<sup>1</sup> Service housing assembly ITEM #18 with part number suffix-J2 includes ITEMS #13, #19, #17, #25, #16, #14, #15 and #20.

<sup>2</sup> Order (2) #032790 ITEM #18A for service housing assembly where manifold ports are used.

Standard seal kit #SK000090 includes six #032821 seal rings, #032435 commutator seal, #032377 inner seal, #028516 back up washer, #478036 dirt & water seal, #406018 grease pack, bulletin #050015 and 028552 steel backup washer.

Special seal kit #SK000091 for units that use fire retardant fluids include six #032822 seal rings, #032435 commutator seal, #032809 inner seal, #028516 back up washer, #478036 dirt & water seal, #406018 grease pack, bulletin #050015 and 028552 steel backup washer.

Vespel commutator seal 032751.

For reverse timed manifold, use MF015001.

\* Speed sensor not available in TC Series.

Vespel commutator seal kit #SK000100 includes six #032821 seal rings, #032751 commutator seal, #032377 inner seal, #028516 back up washer, #478036 dirt & water seal, #406018 grease pack, #bulletin 050015 and #028552 steel backup washer.

Vespel commutator/Viton shaft seal kit #SK000230 includes six #032821 seal rings, #032751 Vespel commutator seal, #032809 Viton shaft seal, #028516 back-up washer, #478036 dirt and water seal, #406018 grease pack, bulletin 050015 and #028552 steel back-up washer.



**Chart Use Example:**

TS0045FS770AAXH Torqmotor™ includes part numbers listed to the right of TS (SERIES), 0045 (DISP.), FS (MOUNTING/PORTING), 77(SHAFT), 0 (ROTATION), and AAXH (OPTION) shown in the left hand column of the chart.

**Caution:**

The charted component service information is for the Torqmotors listed only. Refer to the original equipment manufacturer of the equipment using the Torqmotor for assembly numbers not listed below.

SERIES	EXPLODED VIEW										
	ITEM #	5 & 6	7	9	13	14	15	17	19	20	25
	DESCRIPTION	COMMUTATOR & RING ASSY	MANIFOLD (SEE NOTE)	WEAR PLATE	STEEL BUSHING	THRUST WASHER	THRUST BEARING	BACKUP WASHER	STEEL BUSHING	DIRT & WATER SEAL	BACKUP WASHER
TS-	Service Part #	MF018000A1	MF015000	477341	069511	028483	065066	028516	065071	478010	028552

DISPLACEMENT GROUP	EXPLODED VIEW		ROTOR				"L" Dim	
	ITEM #	1	THICKNESS	8A	8B	10		
	DISPLACEMENT (in³/rev)	BOLT (6)	"L" DIM OF ROTOR THICKNESS	ROTOR SET	FREE RUNNING ROTOR SET††	DRIVE LINK		Overall Length
	0036-	2.2	021356	.2750	MF017003	MF017005		MF013000
0045-	2.7	021311	.3169	MF027003	MF027005	MF023000	3.021	
0050-	3.0	021311	.3751	MF037003	MF037005	MF033000	3.080	
0065-	4.0	021306	.5001	MF047003	MF047005	MF043000	3.206	
0080-	5.0	021382	.6258	MF057003	MF057005	MF053000	3.334	
0100-	6.0	021357	.7508	MF067003	MF067005	MF063000	3.460	
0130-	8.0	021307	1.0008	MF087003	MF087005	MF083000	3.712	
0165-	9.9	021358	1.2508	MF107003	MF107005	MF103000	3.969	
0195-	11.9	021308	1.5008	MF127003	MF127005	MF123000	4.215	
0230-	13.9	021359	1.7508	MF147003	MF147005	MF143000	4.467	
0260-	15.9	021310	2.0008	MF167003	MF167005	MF163000	4.718	
0295-	17.9	021383	2.2508	MF187003	MF187005	MF183000	4.970	
0330-	20.0	021384	2.5008	MF207003	MF207005	MF203000	5.220	
0365-	22.6	021460	2.8406	MF227003	N/A	MF223000	5.557	
0390-	24.0	021414	3.0030	MF247003	N/A	MF243000	5.716	

†† Free running rotorset is not available in 0365 or 0390 Displacements.

\* Not released.

HOUSING GROUP	EXPLODED VIEW					
	FRONT PORTING ONLY Mounting Code Porting Code	ITEM #	2	18	4	16
		DESCRIPTION	PORTING	6 BOLT END COVER	6 BOLT HOUSING SERVICE PART #	O-RING (5)
	FS-	4 Bolt	7/8" O-Ring	MF016007	TS012201A2	032822

STAINLESS STEEL COUPLING SHAFT GROUP	EXPLODED VIEW				
	ITEM #	12	12A		
	DESCRIPTION	COUPLING SHAFT	STAINLESS KEY	PROTECTIVE COVER	COVER O-RING
77-	1" Dia. 1/4" Square Key, 1/4"-20 Tap	TS019400	039053 (1/4x1/4x1.33)	420007	032013

OPTION GROUP	EXPLODED VIEW				
	ITEM #		3	22	23
	DESCRIPTION		COMMUTATOR SEAL	O-RING	PROTECTIVE COVER
AAXH	Fluorocarbon (Viton) Dirt & Water Seal, Protective Motor Cover w/Fluorocarbon (Viton) Seal, Stainless Steel Housing & Shaft, Fluorocarbon (Viton) (Body & Shaft Seals), Vespe™ Commutator Seal, No Paint		032435	032013	420007
AAXW	Fluorocarbon (Viton) Dirt & Water Seal, Protective Motor Cover w/Fluorocarbon (Viton) Seal, Stainless Steel Housing & Shaft, Fluorocarbon (Viton) (Body & Shaft Seals), Vespe™ Commutator Seal, Vespe™ Thrust Bearing, No Paint		032435	032013	420007



**TB Service Parts List Chart**

**TC, TS, TB, TE, TJ, TF, TG, TH and TL Series**

**Chart Use Example:**

TB0045AS010AAAB Torqmotor™ includes part numbers listed to the right of TB (SERIES), 0045 (DISP.), AS (MOUNTING/PORTING), 01(SHAFT), 0 (ROTATION), and AAAB (OPTION) shown in the left hand column of the chart.

**Caution:**

The charted component service information is for the Torqmotors listed only. Refer to the original equipment manufacturer of the equipment using the Torqmotor for assembly numbers not listed below.

SERIES	EXPLODED VIEW										
	ITEM #	5 & 6	7	9	<sup>A</sup> 13	14	15	17	<sup>A</sup> 19	20	25
	DESCRIPTION	COMMUTATOR & RING ASSY	MANIFOLD (SEE NOTE)	WEAR PLATE	BRONZE BUSHING	THRUST WASHER	THRUST BEARING	BACKUP WASHER	"DU" BEARING	DIRT & WATER SEAL	BACKUP WASHER
TB-	Service Part #	MF018000A1	MF015000	477341	069511	028483	065066	028516	065505	478036	028552

DISPLACEMENT GROUP	EXPLODED VIEW				ROTOR					Overall Length
	ITEM #	1	or 1A	or 1C	THICKNESS	8A	8B	10	"L" Dim	
	DISPLACEMENT (in <sup>3</sup> /rev)	BOLT (5) <sup>†</sup>	BOLT (5)	BOLT (5)	"L" DIM OF ROTOR THICKNESS	ROTOR SET	FREE RUNNING ROTOR SET <sup>††</sup>	DRIVE LINK		
	0036- 2.2	021356				.2750	MF017003	MF017005	MF013000	
0045- 2.7	021311	021433	021308		.3169	MF027003	MF027005	MF023000	3.021	
0050- 3.0	021311	021444	021308		.3751	MF037003	MF037005	MF033000	3.080	
0065- 4.0	021306	021358	021435		.5001	MF047003	MF047005	MF043000	3.206	
0080- 5.0	021382	021438	021359		.6258	MF057003	MF057005	MF053000	3.334	
0100- 6.0	021357	021308	021445		.7508	MF067003	MF067005	MF063000	3.460	
0130- 8.0	021307	021359	021439		1.0008	MF087003	MF087005	MF083000	3.712	
0165- 9.9	021358	021310	*		1.2508	MF107003	MF107005	MF103000	3.969	
0195- 11.9	021308	021383	021465		1.5008	MF127003	MF127005	MF123000	4.215	
0230- 13.9	021359	021384	021460		1.7508	MF147003	MF147005	MF143000	4.467	
0260- 15.9	021310	021466	021467		2.0008	MF167003	MF167005	MF163000	4.718	
0295- 17.9	021383	021414	*		2.2508	MF187003	MF187005	MF183000	4.970	
0330- 20.0	021384	021459	021448		2.5008	MF207003	MF207005	MF203000	5.220	
0365- 22.6	021460	021448	*		2.8406	MF227003	N/A	MF223000	5.557	
0390- 24.0	021414	021449	021464		3.0030	MF247003	N/A	MF243000	5.716	

<sup>†</sup> Bolts for TB Series front ported units are the same as rear ported units.

<sup>††</sup> Free running rotorset is not available in 0365 or 0390 Displacements.

\* Not released.

FRONT PORTING	Mounting Code Porting Code	EXPLODED VIEW			
		ITEM #	2	<sup>1,2</sup> 18	<sup>A</sup> 18A
		DESCRIPTION	PORTING	END COVER	HOUSING SERVICE PART #
MS-	Standard (4 Bolt)	7/8" O-Ring	MF016000	MF012014A2	
AS-	SAE A (2 Bolt)	7/8" O-Ring	MF016000	MF012001A2	
FS-	4 Bolt	7/8" O-Ring	MF016000	MF012003A2	
AM-	SAE A (2 Bolt)	Manifold	MF016000	MF012004A2	032790
FM-	4 Bolt	Manifold	MF016000	MF012005A2	032790
MM-	Standard (4 Bolt)	Manifold	MF016000	MF012049A2	032790
AP-	SAE A (2 Bolt)	1/2" NPTF	MF016000	MF012006A2	
FP-	4 Bolt	1/2" NPTF	MF016000	MF012007A2	
AT-	SAE A (2 Bolt)	1/2" BSPF	MF016000	MF012011A2	
BP-	SAE B (2 Bolt)	1/2" NPTF	MF016000	MF012073A2	

HOUSING GROUP	REAR PORTING	Mounting Code Porting Code	EXPLODED VIEW			
			ITEM #	2	<sup>1B</sup> 18	<sup>A</sup> 18A
			DESCRIPTION	PORTING	END COVER	HOUSING SERVICE PART #
AR-	SAE A (2 Bolt)	Rear (3/4"-16 SAE O-Ring)	MF016001	MF012008A2		
FR-	4 Bolt	Rear (3/4"-16 SAE O-Ring)	MF016001	MF012010A2		
BR-	SAE B (2 Bolt)	Rear (3/4"-16 SAE O-Ring)	MF016001	MF012076A2		



EXPLODED VIEW		12	12A	12B
ITEM #	DESCRIPTION	COUPLING SHAFT	WOODRUFF KEY	NUT
COUPLING SHAFT GROUP	01- Long 6B Snapwire Groove	MF019007		
	09- 1" Ø, 0.38 Pinhole, 0.55" from end	MF019000		
	10- 1" Short Woodruff Key 1/4" Tap	MF019006	038015 (1/4x1)	
	11- 1" Short 6B Spline, 1/4" Snapwire Groove	MF019003		
	12- 1" Tapered (Short)	MF019004	038015 (1/4x1)	025136
	13- 1" Long Woodruff Snapwire Groove	MF019005	038015 (1/4x1)	
	14- 1" Ø, Double Pinhole	MF019001		
	15- 1" Ø, 0.32 Pinhole 0.4" from end	MF019002		
	21- "-10 Code" plus Corrosion Resistant	MF019008		
	22- 25 mm Straight with 7 mm Keyway, 6 mm Tap	MF019009		
	25- 1" Tapered SAE	MF019011	038015 (1/4x1)	025136
	26- 25 mm Straight with 8 mm Keyway	MF019012	039042	
	28- 13 Tooth Spline	MF019014		
	33- 1" Tapered, 3/16 Key, 3/4-16 Thd	MF019016		
	40- Short Wood, 6mm Tap	MF019021		

EXPLODED VIEW		2	3	4	16	21	22	23	24	
ITEM #	DESCRIPTION	BOLTS (5)	END COVER	COMMUTATOR SEAL RING (5)	INNER SEAL	PLUG & O-RING ASSY	O-RING	SPRING	VALVE W/SPRING	
OPTION GROUP	AAAB No Paint	Item #1		032435	032821	032377				
	AAAC Corrosion Resistant Paint	Item #1		032435	032821	032377				
	AAAH Fluorocarbon Seals	Item #1		032435	032822	032809				
	BBCB 1740 PSI Internal Bidirectional Relief, No Paint	Item #1C	MF016006A7	032435	032821	032377	036297	032750	401660	4100107
	BBCM 1200 PSI Internal Bidirectional Relief, No Paint	Item #1C	MF016006A31	032435	032821	032377	036297	032750	401660	41001031
	BBCN 2030 PSI Internal Bidirectional Relief, No Paint	Item #1C	MF016006A5	032435	032821	032377	036297	032750	401660	4100105
	BBCP 1450 PSI Internal Bidirectional Relief, No Paint	Item #1C	MF016006A10	032435	032821	032377	036297	032750	401660	41001010
	BBCP 1450 PSI Internal Bidirectional Relief, No Paint	Item #1C	MF016006A10	032435	032821	032377	036297	032750	401660	41001010
	BBCP 1450 PSI Internal Bidirectional Relief, No Paint	Item #1C	MF016006A10	032435	032821	032377	036297	032750	401660	41001010
	BBCP 1450 PSI Internal Bidirectional Relief, No Paint	Item #1C	MF016006A10	032435	032821	032377	036297	032750	401660	41001010
	AAJV Bidirectional Shuttle Valve (3:30), Black Paint	Item #1A	MF016003A1	032435	032821	032377	036297	032750	401660	415603

<sup>1</sup> Service housing ass'y ITEM #18 with part number suffix-A2 includes ITEM #13 and #19.

<sup>2</sup> Order (2) #032790 ITEM #18A for service housing assembly where manifold ports are used.

Standard seal kit #SK000090 includes six #032821 seal rings, #032435 commutator seal, #032377 inner seal, #028516 back up washer, #478036 dirt & water seal, #406018 grease pack, bulletin #050015 and 028552 backup washer.

Special seal kit #SK000091 for units that use fire retardant fluids include six #032822 seal rings, #032435 commutator seal, #032809 inner seal, #028516 back up washer, #478036 dirt & water seal, #406018 grease pack, bulletin #050015 and 028552 backup washer.

Vespel commutator seal 032751.

For reverse timed manifold, use MF015001.

\* Speed sensor not available in TB Series.

Commutator set for rear ported units MF018001A1

Vespel commutator seal kit #SK000100 includes six #032821 seal rings, #032751 commutator seal, #032377 inner seal, #028516 back up washer, #478036 dirt & water seal, #406018 grease pack, #bulletin 050015 and #028552 steel backup washer.

Vespel commutator/Viton shaft seal kit #SK000230 includes six #032821 seal rings, #032751 Vespel commutator seal, #032809 Viton shaft seal, #028516 back-up washer, #478036 dirt and water seal, #406018 grease pack, bulletin 050015 and #028552 steel back-up washer.



**Chart Use Example:**

TE0045AS010AAAB Torqmotor™ includes part numbers listed to the right of TE (SERIES), 0045 (DISP.), AS (MOUNTING/PORTING), 01(SHAFT), 0 (ROTATION), and AAAB (OPTION) shown in the left hand column of the chart.

**Caution:**

The charted component service information is for the Torqmotors listed only. Refer to the original equipment manufacturer of the equipment using the Torqmotor for assembly numbers not listed below.

SERIES	EXPLODED VIEW										
	ITEM #	5 & 6	7	9	13	14	15	17	19	20	25
	DESCRIPTION	COMMUTATOR & RING ASSY	MANIFOLD (SEE NOTE)	WEAR PLATE	THRUST BEARING	THRUST WASHER	THRUST BEARING	BACKUP WASHER	DIRT & WATER BEARING	DIRT & WATER SEAL	BACKUP WASHER
TE-	Service Part #	MF018000A1	MF015000	477341	069512	028483	065066	028516	065506	478036	028552

DISPLACEMENT GROUP	EXPLODED VIEW				ROTOR					
	ITEM #	1	or 1A	or 1C	THICKNESS	8A	8B	10	"L" Dim	
	DISPLACEMENT (in <sup>3</sup> /rev)	BOLT (6)†	BOLT (6)	BOLT (5)	"L" DIM. OF ROTOR THICKNESS	ROTOR SET	FREE RUNNING ROTOR SET††	DRIVE LINK	Overall Length	
	0036- 2.2	021356				.2750	MF017003	MF017005	MF013000	2.975
0045- 2.7	021311	021433	021308	.3169	MF027003	MF027005	MF023000	3.021		
0050- 3.0	021311	021444	021308	.3751	MF037003	MF037005	MF033000	3.080		
0065- 4.0	021306	021358	021435	.5001	MF047003	MF047005	MF043000	3.206		
0080- 5.0	021382	021438	021359	.6258	MF057003	MF057005	MF053000	3.334		
0100- 6.0	021357	021308	021445	.7508	MF067003	MF067005	MF063000	3.460		
0130- 8.0	021307	021359	021439	1.0008	MF087003	MF087005	MF083000	3.712		
0165- 9.9	021358	021310	*	1.2508	MF107003	MF107005	MF103000	3.969		
0195- 11.9	021308	021383	021465	1.5008	MF127003	MF127005	MF123000	4.215		
0230- 13.9	021359	021384	021460	1.7508	MF147003	MF147005	MF143000	4.467		
0260- 15.9	021310	021446	021467	2.0008	MF167003	MF167005	MF163000	4.718		
0295- 17.9	021383	021414	*	2.2508	MF187003	MF187005	MF183000	4.970		
0330- 20.0	021384	021459	021448	2.5008	MF207003	MF207005	MF203000	5.220		
0365- 22.6	021460	021448	*	2.8406	MF227003	N/A	MF223000	5.557		
0390- 24.0	021414	021449	021464	3.0030	MF247003	N/A	MF243000	5.716		

† Bolts for TE Series front ported units are the same as rear ported units.

†† Free running rotorset is not available in 0365 or 0390 displacements.

\* Not released.

FRONT PORTING	EXPLODED VIEW							SPEED SENSOR	
	Mounting Code	Porting Code	ITEM #	2	1418	18	1218A	18	18
	DESCRIPTION	PORTING	6 BOLT END COVER	5 BOLT HSG SERVICE PART #	6 BOLT HSG SERVICE PART #	O-RING (2)	6 BOLT HSG SERVICE PART #	SENSOR	
MS-	Standard (4 Bolt)	7/8" O-Ring	MF016007	MF012014A1	MF012214A1		MF012314A1	455069	
AS-	SAE A (2 Bolt)	7/8" O-Ring	MF016007	MF012001A1	MF012201A1		MF012301A1	455069	
US-	Wheel Mount	7/8" O-Ring	MF016007	MF012002A1	MF012202A1		MF012302A1	455069	
FS-	4 Bolt	7/8" O-Ring	MF016007	MF012003A1	MF012203A1		MF012303A1	455069	
AM-	SAE A (2 Bolt)	Manifold	MF016007	MF012004A1	MF012204A1	032790	MF012304A1	455069	
FM-	4 Bolt	Manifold	MF016007	MF012005A1	MF012205A1	032790			
MM-	Standard (4 Bolt)	Manifold	MF016007	MF012049A1	MF012249A1	032790			
AP-	SAE A (2 Bolt)	1/2" NPTF	MF016007	MF012006A1	MF012206A1		MF012306A1	455069	
FP-	4 Bolt	1/2" NPTF	MF016007	MF012007A1	MF012207A1		MF012307A1	455069	
AT-	SAE A (2 Bolt)	1/2" BSPF	MF016007	MF012011A1	MF012211A1				

HOUSING GROUP	EXPLODED VIEW					SPEED SENSOR	
	Mounting Code	Porting Code	ITEM #	2	1418	18	18
	DESCRIPTION	PORTING	5 BOLT END COVER	5 BOLT HSG SERVICE PART #	5 BOLT HSG SERVICE PART #	5 BOLT HSG SERVICE PART #	SENSOR
MR-	Standard (4 Bolt)	Rear Port (3/4"-16 SAE O-Ring)	MF016001	MF012021A1			
UR-	Small Wheel Mount	Rear Port (3/4"-16 SAE O-Ring)	MF016001	MF012009A1		N/A	455069
FR-	4 Bolt Mount	Rear Port (3/4"-16 SAE O-Ring)	MF016001	MF012010A1			
AR-	SAE A (2 Bolt)	Rear Port (3/4"-16 SAE O-Ring)	MF016001	MF012008A1		N/A	455069

NOTE: Rear ported TE motors always have 5 bolts at the back end cover.



EXPLODED VIEW					SPEED SENSOR
ITEM #		12	12A	12B	12
	DESCRIPTION	COUPLING SHAFT	WOODRUFF KEY	NUT	COUPLING SHAFT
COUPLING SHAFT GROUP	01- Long 6B Snapwire Groove	MF019007			MF019307
	09- 1" Ø, 0.38 "Pinhole, 0.55" from end	MF019000			
	10- 1" Short Woodruff Key 1/4" Tap	MF019006	038015 (1/4x1)		MF019306
	11- 1" Short 6B Spline, 1/4" Snapwire Groove	MF019003			MF019303
	12- 1" Tapered (Short)	MF019004	038015 (1/4x1)	025136	MF019304
	13- 1" Long Woodruff Snapwire Groove	MF019005	038015 (1/4x1)		MF019305
	14- 1" Ø, Double Pinhole	MF019001			
	15- 1" Ø, 0.32 "Pinhole 0.4" from end	MF019002			
	21- "-10 Code" plus Corrosion Resistant	MF019008			MF019308
	22- 25 mm Straight Shaft with 7 mm Keyway	MF019009	039041		
	25- 1" Tapered SAE	MF019011	038015 (1/4x1)	025136	MF019311
	26- 25 mm Straight with 8 mm Keyway	MF019012	039042		MF019312
	28- 13 Tooth Spline	MF019014			MF019314
	69- 25mm Straight with 8mm (stainless steel)	MF019412			
	70- 1" dia short, woodruff key, 1/4 tap (stainless steel)	MF019406			
75- 1" dia long, woodruff key, 1/4 tap (stainless steel)	MF019446				

EXPLODED VIEW								
ITEM #		*1, 1A, 1C	2	2	3	4	16	
	DESCRIPTION	BOLT	5 BOLT END COVER	6 BOLT END COVER	COMMUTATOR SEAL	SEAL RING (5)	INNER SEAL	SENSOR
OPTION GROUP	AAAA Standard Black Paint	Item #1		MF016007	032435	032821	032377	
	AAAB No Paint	Item #1		MF016007	032435	032821	032377	
	AAAC Corrosion Resistant Paint	Item #1		MF016007	032435	032821	032377	
	AAAG Fluorocarbon Seals	Item #1		MF016007	032435	032822	032809	
	AABJ Free Running Rotor Set	Item #1		MF016007	032435	032821	032377	
	BBCK 1740 PSI Internal Bidirectional Relief, No Paint	Item #1C	MF016006A7	N/A				
	BBCM 1200 PSI Internal Bidirectional Relief, No Paint	Item #1C	MF016006A31	N/A				
	BBCN 2030 PSI Internal Bidirectional Relief, No Paint	Item #1C	MF016006A5	N/A				
	BBCP 1450 PSI Internal Bidirectional Relief, No Paint	Item #1C	MF016006A10	N/A				
	BBCT 1560 PSI Internal Bidirectional Relief, No Paint	Item #1C	MF016006A2	N/A				
	AAJV Bidirectional Shuttle Valve (3:30), Black Paint	Item #1A	MF016003A1	MF016009A1	032435	032821	032377	
	FSAA Speed Sensor, Black Paint	Item #1		MF016007	032435	032821	032377	455069
	FSAB Speed Sensor, No Paint	Item #1		MF016007	032435	032821	032377	455069
	FSAH Speed Sensor, Castle Nut, No Paint	Item #1		MF016007	032435	032821	032377	455069
	FSAJ Speed Sensor, Castle Nut, Black Paint	Item #1		MF016007	032435	032821	032377	455069

<sup>1</sup> Service housing ass'y ITEM #18 with part number suffix-A1 includes ITEM #13, #14, #15 and #19.

<sup>2</sup> Select the required bolt number in designated "DISPLACEMENT GROUP" under bolt ITEM #1, 1A, 1B or 1C shown in designated "OPTION GROUP"

<sup>3</sup> Castle Nut #025156 is required if the designated "OPTION GROUP" is AAAF, AAAAN, or AAAU.

<sup>4</sup> Order (2) #032790 ITEM #18A for service housing assembly where manifold ports are used.

Standard seal kit #SK000090 includes six #032821 seal rings, #032435 commutator seal, #032377 inner seal, #028516 backup, #478036 dirt & water seal, #406018 grease pack, bulletin #050015 and #028552 backup washer.

Special seal kit #SK000091 for units that use fire retardant fluids include six

Vespel commutator seal kit #SK000100 includes six #032821 seal rings, #032751 commutator seal, #032377 inner seal, #028516 back up washer, #478036 dirt & water seal, #406018 grease pack, #bulletin 050015 and #028552 steel backup washer.

#032822 seal rings, #032435 commutator seal, #032809 inner seal, #028516 back up ring, #478036 dirt & water seal, #028552 backup washer, #406018 grease pack and bulletin #050015.

For reverse timed manifold, use MF015001.

Vespel commutator seal 032751.

Commutator set for rear ported unit MF018001A1

\* TD Series motors were (5) five bolt end cover with (5) five bolt housing. The newly released TE Series motors are (6) six bolt end cover with (6) bolt housing.

**Chart Use Example:**

TJ0045US080AAAB Torqmotor™ includes part numbers listed to the right of TJ (SERIES), 0045 (DISP.), US (MOUNTING/PORTING), 08(SHAFT), 0 (ROTATION), and AAAB (OPTION) shown in the left hand column of the chart.

**Caution:**

The charted component service information is for the Torqmotors listed only. Refer to the original equipment manufacturer of the equipment using the Torqmotor for assembly numbers not listed below.

SERIES	EXPLODED VIEW										
	ITEM #	'5 & 6	7	9	'13	'14	'15	17	'19	20	25
	DESCRIPTION	COMMUTATOR ASSEMBLY	MANIFOLD (SEE NOTE)	WEAR PLATE	INNER BEARING	THRUST WASHER(2)	THRUST BEARING	BACKUP WASHER	OUTER BEARING	DIRT & WATER SEAL	BACKUP WASHER
TJ-	Service Part #	MF018000A1	MF015000	477341	069513	028348	069030	028515	068027	478035	029118

DISPLACEMENT GROUP	EXPLODED VIEW			ROTOR					Overall Length	
	ITEM #	1	or 1A	or 1C	THICKNESS	8A	8B	10		"L" Dim
	DISPLACEMENT (in <sup>3</sup> /rev)	BOLT (6)	BOLT (6)	BOLT (6)	"L" DIM. OF ROTOR THICKNESS	ROTOR SET	FREE RUNNING ROTOR SET <sup>††</sup>	DRIVE LINK		
0036-	2.2	021311			.2750	MF017003	MF017005	MF013000	2.975	
0045-	2.7	021311	021433	021308	.3169	MF027003	MF027005	MF023000	3.021	
0050-	3.0	021311	021444	021308	.3751	MF037003	MF037005	MF033000	3.080	
0065-	4.0	021306	021358	021435	.5001	MF047003	MF047005	MF043000	3.206	
0080-	5.0	021382	021438	021359	.6258	MF057003	MF057005	MF053000	3.334	
0100-	6.0	021357	021308	021445	.7508	MF067003	MF067005	MF063000	3.460	
0130-	8.0	021307	021359	021439	1.0008	MF087003	MF087005	MF083000	3.712	
0165-	10.0	021358	021310	*	1.2508	MF107003	MF107005	MF103000	3.969	
0195-	12.0	021308	021383	021465	1.5008	MF127003	MF127005	MF123000	4.215	
0230-	14.0	021359	021384	021460	1.7508	MF147003	MF147005	MF143000	4.467	
0260-	16.0	021310	021446	021467	2.0008	MF167003	MF167005	MF163000	4.718	
0295-	18.0	021383	021414	*	2.2508	MF187003	MF187005	MF183000	4.970	
0330-	20.0	021384	021459	021448	2.5008	MF207003	MF207005	MF203000	5.280	
0365-	22.6	021460	021448	*	2.8406	MF227003	N/A	MF223000	5.557	
0390-	24.0	021414	021449	021464	3.0030	MF247003	N/A	MF243000	5.716	

<sup>††</sup> Free running rotorset is not available in 0365 or 0390 displacements.  
 \* Not released.

HOUSING GROUP Mounting Code Porting Code	EXPLODED VIEW			COUPLING SHAFT GROUP	EXPLODED VIEW			
	ITEM #				ITEM #	12	12A	12B
	DESCRIPTION	SERVICE HOUSING ASS'Y		COUPLING				
	MOUNTING	PORTING		DESCRIPTION	SHAFT	KEY	NUT	
US-	Wheel Mount (4 Bolt)	7/8"-14 SAE O-Ring	MP012002A1	08-	1 1/4" Tapered	MP019000	038016 (5/16x1)	025126

OPTION GROUP	EXPLODED VIEW					
	ITEM #	'1, 1A, 1C			16	
	DESCRIPTION	BOLT	END COVER	COMMUTATOR SEAL	SEAL RING (5)	INNER SEAL
AAAB	No Paint	ITEM #1	MF016007	032435	032821	032817
AAAC	Corrosion Resistant Paint	ITEM #1	MF016007	032435	032821	032817
AAAG	Fluorocarbon Seals	ITEM #1	MF016007	032435	032822	032818
AABJ	Free Running Rotor Set	ITEM #1	MF016007	032435	032821	032817
BBCK	1740 PSI Internal Bidirectional Relief, No Paint	ITEM #1C	MF016006A7			
BBCM	1200 PSI Internal Bidirectional Relief, No Paint	ITEM #1C	MF016006A31			
BBCN	2030 PSI Internal Bidirectional Relief, No Paint	ITEM #1C	MF016006A5			
BBCP	1450 PSI Internal Bidirectional Relief, No Paint	ITEM #1C	MF016006A10			
BBC T	1560 PSI Internal Bidirectional Relief, No Paint	ITEM #1C	MF016006A2			
AAJV	Bidirectional Shuttle Valve (3:30), Black Paint	ITEM #1A	MF016009A1	032435	032821	032817

<sup>1</sup> Service housing ass'y ITEM #18 with part number suffix-A1 includes ITEM #13, #14, #15 and #19.

<sup>2</sup> Order (2) #032790 ITEM #18A for service housing assembly where manifold ports are used.

<sup>3</sup> Nut #025113 is required if the designated "OPTION GROUP" is AAAF, AAAN, or AAUU.

Standard seal kit #SK000146 includes five #032821 seal rings, #032435 commutator seal, #032817 shaft seal, #028515, backup ring #050016 and #029118 backup washer, #478035 dirt & water, #406018 grease pack, bulletin #050016.

Special seal kit #SK000148 for units that use fire retardant fluids or higher temperature oil includes five #032822 seal rings, #032435 commutator seal, #032818 shaft seal, #028515 backup ring, #478035 dirt & water seal, #406018 grease pack, #029118 backup washer, #050016 bulletin.

Vespel commutator seal 032751.

For reverse timed manifold, use MF015001.



TF Service Parts List Chart

Torqmotor™ Service Procedure

TC, TS, TB, TE, TJ, TF, TG, TH and TL Series

Chart Use Example:

TF0080AS010AAAB Torqmotor™ includes part numbers listed to the right of TF (SERIES), 0080 (DISP.), AS (MOUNTING/PORTING), 01(SHAFT), 0 (ROTATION), and AAAA (OPTION) shown in the left hand column of the chart.

Caution:

The charted component service information is for the Torqmotors listed only. Refer to the original equipment manufacturer of the equipment using the Torqmotor for assembly numbers not listed below.

EXPLODED VIEW												
SERIES	ITEM #	'5 & 6	7	9	11	'13	'14	'15	17	'19	20	25
	DESCRIPTION	COMMUTATOR ASSEMBLY	MANIFOLD (SEE NOTE)	WEAR PLATE	THRUST BEARING	INNER BEARING	THRUST WASHER(2)	THRUST BEARING	BACKUP WASHER	OUTER BEARING	DIRT & WATER SEAL	BACKUP WASHER
TF-	Service Part #	ME018000A1	ME015000	477342	068024	071019	400136	069017	028515	068027	478035	029118

EXPLODED VIEW <sup>2</sup> (SELECT ITEM # BOLT PER OPTION GROUP)											
DISPLACEMENT GROUP	ITEM #	1 OR 1A OR 1B OR 1C				8A	8B	10		"L DIM"	
	DISPLACEMENT (in <sup>3</sup> /rev)	BOLT (7)	BOLT (7)	BOLT (7)	BOLT (7)	ROTOR THICKNESS	ROTOR SET	ROTOR SET	DRIVE LINK	12 TOOTH	14 TOOTH
	0080-	4.9	021326	021340	021273	021413	.4393	MB057003	MB057005	MB063000	4.262"
0100-	6.1	021326	021340	021273	021413	.4393	MB067003	MB067005	MB063000	4.262"	
0130-	7.8	021271	021386	021273	021279	.5643	MB087003	MB087005	MB083000	4.388"	
0140-	8.6	021390	021273	021273	021379	.6268	MB097003	MB097005	MB093000	4.451"	
0170-	10.3	021376	021387	021387	021392	.7518	MB107003	MB107005	MB103000	4.577"	
0195-	12.0	021352	021379	021379	021291	.8768	MB127003	MB127005	MB123000	4.703"	
0240-	14.5	021272	021291	021291	021412	1.0643	MB157003	MB157005	MB153000	4.892"	
0280-	17.1	021340	021392	021392	021385	1.2518	MB187003	MB187005	MB183000	5.081"	
0360-†	22.2	021387	021378	021378	021415	1.5018	ME237003	ME237007	ME233000		5.458"
0365-	22.2	021387	021378	021378	021415	1.6268	MB237003	MB237005	MB233000	5.458"	
0405-†	24.7	021379	021366	021415	021374	1.7923	ME247003	ME247007	ME243000		5.604"
0475-†	29.1	021392	021394	021394	021393	2.1268	ME297003	ME297007	ME293000		5.947"

† (Not available in clutch motor)

FRONT PORTING	Mounting Code Porting Code	EXPLODED VIEW				SPEED SENSOR	
		ITEM #	2		'18		
		DESCRIPTION	END COVER	SERVICE HOUSING ASS'Y	SERVICE HOUSING ASS'Y	SENSOR	
	MS-	Standard (4 Bolt)	7/8" O-Ring	ME016000	ME012001A1	ME012301A1	455069
	US-	Wheel Mt. (4 Bolt)	7/8" O-Ring	ME016000	ME012002A1	ME012301A1	455069
	AS-	SAE A (2 Bolt)	7/8" O-Ring	ME016000	ME012006A1	ME012306A1	455069
	HS-	Whl. (US) w/Machined Pilot Nose	7/8" O-Ring	ME016000	ME012008A1		
	LS-	Whl. w/Brake Mt. (4 Bolt)	7/8" O-Ring	ME016000	ME012009A1		
	BS-	SAE B (2 Bolt)	7/8" O-Ring	ME016000	ME012019A1	ME012319A1	455069
	GS-	Clutch Motor	7/8" O-Ring	ME016000	ME012013A1		
	AM-	SAE A (2 Bolt)	Manifold	ME016000	ME012028A1	ME012328A1	455069
	MM-	Standard (4 Bolt)	Manifold	ME016000	ME012018A1		
	AT-	SAE A (2 Bolt)	1/2" BSPF	ME016000	ME012027A1		
	MT-	Standard (4 Bolt)	1/2" BSPF	ME016000	ME012010A1	ME012310A1	455069

HOUSING GROUP	REAR PORTING	EXPLODED VIEW						SPEED SENSOR	
		ITEM #	1, 1A, 1B, 1C		2	'18			
		DESCRIPTION	REAR PORT	BOLT	END COVER	SERVICE HOUSING ASS'Y	SERVICE HOUSING ASS'Y	SENSOR	
	MA-	Standard (4 Bolt)	Rear Port (7/8" O-Ring; Axial)	Item #1B	ME016009	ME012004A1			
	UA-	Wheel Mt. (4 Bolt)	Rear Port (7/8" O-Ring; Axial)	Item #1B	ME016009	ME012005A1			
	AA-	SAE A (2 Bolt)	Rear Port (7/8" O-Ring; Axial)	Item #1B	ME016009	ME012007A1	ME012307A1	455069	
	WA-	Wheel, Optional (4 Bolt)	Rear Port (7/8" O-Ring; Axial)	Item #1B	ME016009	ME012011A1			
	VA-	SAE A (4 Bolt)	Rear Port (7/8" O-Ring; Axial)	Item #1B	ME016009	ME012049A1			
	MB-	Standard (4 Bolt)	Rear Port (7/8" O-Ring; Radial)	Item #1B	ME016002	ME012004A1			
	UB-	Wheel Mt. (4 Bolt)	Rear Port (7/8" O-Ring; Radial)	Item #1B	ME016002	ME012005A1			
	AB-	SAE A (2 Bolt)	Rear Port (7/8" O-Ring; Radial)	Item #1B	ME016002	ME012007A1	ME012307A1	455069	
	WB-	Wheel, Optional (4 Bolt)	Rear Port (7/8" O-Ring; Radial)	Item #1B	ME016002	ME012011A1			
	VB-	SAE A (4 Bolt)	Rear Port (7/8" O-Ring; Radial)	Item #1B	ME016002	ME012049A1			
	ME-	Standard (4 Bolt)	Rear Port (Manifold; Radial)	Item #1B	ME016001J1	ME012004A1			
	UE-	Wheel Mt. (4 Bolt)	Rear Port (Manifold; Radial)	Item #1B	ME016001J1	ME012005A1			
	AE-	SAE A (2 Bolt)	Rear Port (Manifold; Radial)	Item #1B	ME016001J1	ME012007A1	ME012307A1	455069	
	WE-	Wheel, Optional (4 Bolt)	Rear Port (Manifold; Radial)	Item #1B	ME016001J1	ME012011A1			
	VE-	SAE A (4 Bolt)	Rear Port (Manifold; Radial)	Item #1B	ME016001J1	ME012049A1			



COUPLING SHAFT GROUP	EXPLODED VIEW		SPEED	CLUTCH						
	ITEM #	12	SENSOR	MOTOR	12A	12B	12C	12D	12E	12F
	DESCRIPTION	COUPLING SHAFT	COUPLING SHAFT	COUPLING SHAFT	KEY	NUT	WASHER	5/8-18 BOLT	LOCK WASHER	RETAINING RING
01-	Long 6B Snapwire Groove	MB019001	MB019301							
02-	Long Woodruff, 1/4" Tap Snapwire Groove	MB019002	MB019302		038015					
03-	1.25" Straight Keyed 5/8-18 Int. Thd.	MB019003	MB019303	093044	039028		028413	021482	028992	401333
04-	10B Spline	MB019004	MB019304							
05-	14 Tooth Spline 5/8-18 Int. Thd.	MB019005	MB019305	093043			028413	021482	028992	
06-	19 Tooth Spline	MB019006								
07-	15 Tooth Spline	MB019007	MB019307							
08-	1.25" Tapered Shaft	MB019000	MB019300		038016		025126			
17-	19 Tooth Spline (16/32)	MB019011								
22-	25mm Str. w/7mm Key	MB019009	MB019309							
26-	25mm Str. w/8mm Key	MB019017	MB019317							
28-	13 Tooth Spline (16/32)	MB019023	MB019323							
58-	1.25" Str. Nitrotec C	MB019040								

COUPLING SHAFT GROUP FOR DISP-0360, -0405, -0475 ONLY†	EXPLODED VIEW		SPEED SENSOR	
	ITEM #	12	12	
	DESCRIPTION	COUPLING SHAFT	COUPLING SHAFT	SENSOR
01-	Long 6B Snapwire Groove	ME019001	ME019301	455069
02-	Long Woodruff, 1/4" Tap Snapwire Groove	ME019002	ME019302	455069
03-	1.25" Straight Keyed 5/8-18 Int. Thd.	ME019003	ME019303	455069
04-	10B Spline	ME019004	ME019304	
05-	14 Tooth Spline 5/8-18 Int. Thd.	ME019005	ME019305	455069
06-	19 Tooth Spline	ME019006		
07-	15 Tooth Spline	ME019007		
08-	1.25" Tapered Shaft	ME019000	ME019300	455069
19-	1.38" Tapered 1.125-18 Thd.	ME019010		
20-	1.38" Straight Key 5/8 Tap	ME019011	ME019311	

† (Not available in clutch motor)

OPTION GROUP	EXPLODED VIEW											
	ITEM #	2 <sup>1</sup> , 1A, 1B, 1C	2	3	4	16	6 <sup>21</sup> & 22	4 <sup>6</sup> 22	6 <sup>23</sup>	6 <sup>24</sup>	12B	
	DESCRIPTION	BOLT (7)	END COVER	COMMUTATOR SEAL	SEAL RING (5)	INNERPLUG & O-RING SEAL	ASSEMBLY	O-RINGS	SPRING (2)	VALVE	CASTLE NUT	SENSOR
AAAA	Black Paint	Item #1		032435	032819	032817						
AAAC	Corrosion Resistant Paint	Item #1		032435	032819	032817						
AAAF	Castle Nut Replacing Patch Lock Nut	Item #1		032435	032819	032817					025113	
AAAG	Fluorocarbon Seals, Black Paint	Item #1		032435	032820	032818						
AAAH	Fluorocarbon Seals, No Paint	Item #1		032435	032820	032818						
AAAT	Bidirectional Shuttle Valve 11:00	Item #1A	6ME016003A1	032435	032819	032817	036297	032791	401642	415569		
AAAU	Bidirectional Shuttle Valve 11:00 & Castle Nut	Item #1A	6ME016003A1	032435	032819	032817	036297	032791	401642	415569	025113	
BBBA	1000 PSI Cross Port Relief Endcover, Black Paint	Item #1C	6ME016004A1	032435	032819	032817	411063A1	032424		41001210	(2), 1000 PSI	
BBBG	1500 PSI Cross Port Relief Endcover, Black Paint	Item #1C	ME016004A5	032435	032819	032817	411063A1	032424		41000976	(2), 1500 PSI	
BBBB	2000 PSI Cross Port Relief Endcover, Black Paint	Item #1C	6ME016004A2	032435	032819	032817	411063A1	032424		41001220	(2), 2000 PSI	
BBCG	2500 PSI Int. Bidirectional Relief Endcover, No Paint	Item # 1C	ME016004A6	032435	032819	032817	411063A1	032424		41001225	(2), 2500 PSI	
BBCX	2500 PSI Int. Bidirectional Relief Endcover, No Nut, Black Paint	Item # 1C	ME016004A6	032435	032819	032817	411063A1	032424		41001225	(2), 2500 PSI	
BBCW	3000 PSI Int. Bidirectional Relief Endcover, No Nut, No Paint	Item # 1C	ME016004A3	032435	032819	032817	411063A1	032424		41001230	(2), 3000 PSI	
BBBC	3000 PSI Cross Port Relief Endcover, Black Paint	Item #1C	6ME016004A3	032435	032819	032817	411063A1	032424		41001230	(2), 3000 PSI	
BBBD	4000 PSI Cross Port Relief Endcover, Black Paint	Item #1C	6ME016004A4	032435	032819	032817	411063A1	032424		41001240	(2), 4000 PSI	
DDDA	Clutch Motor	Item #1	ME016000	032435	032819	032817						
FSAA	Speed Sensor Option	Item #1	ME016000	032435	032819	032817						455069

For reverse timed manifold, use ME015001.

<sup>1</sup> Service housing ass'y ITEM #18 with part number suffix-A1 includes ITEM #13, #14 two req'd, #15 and #19.

<sup>2</sup> Select the required bolt number in designated "DISPLACEMENT GROUP" under bolt ITEM #1, 1A, 1B or 1C shown in designated "OPTION GROUP."

<sup>3</sup> 1-20 UNEF slotted nut #025113 is required on 1-1/4" tapered shaft if the designated "OPTION GROUP" is AAAM, AAAN, or AAAP.

<sup>4</sup> ITEM #22 is part of plug & o-ring ass'y's but can be serviced separately.

<sup>5</sup> Service endcover ME016001J1 includes two #032790 o-rings, ITEM 18A on the exploded ass'y view that can also be serviced separately.

<sup>6</sup> End cover assembly item #2 also includes item #21, #22, #24 and if required item #23. All but item #21 can be serviced separately.

<sup>7</sup> ME018001A1 commutator ass'y. is required if the designated "OPTION GROUP" is AAAM, AAAN, or AAAP.

<sup>8</sup> Order (2) #032790 seals for parts when ordering manifold-style porting.

Standard seal kit #SK000092 includes six #032819 seal rings, #032435 commutator seal, #032817 inner seal, #028515 and #029118 back washers, #478035 dirt & water, #406018 grease pack, bulletin #050016.

Special seal kit #SK000093 for units that use fire retardant fluids includes six #032820 seal rings, #032435 commutator seal, #032818 inner seal, #028515 and #029118 back up washers, #478035 dirt & water seal, #406018 grease pack, bulletin #050016.

Vespel commutator seal AADJ #032439. High temperature seal black in color.

\* Standard seal kit #SK000092 for motor only. If repairing clutch, need #SK000039. Kit includes two #067033 bearing and cone assemblies, two #400140 bearing cups, one #400141 thrust washer, one #401622 snap ring, one #401632 retaining ring, and one #478030 dirt and water seal.

#SK000099 Vespel commutator seal kit, #032439 Vespel seal, #032817 inner seal, #028515 and #029118 back up washers, #478035 dirt & water seal, #032819 six seal rings, #406018 grease pack, bulletin #050016.





**Chart Use Example:**

TG0140AS010AAAB Torqmotor™ includes part numbers listed to the right of TG (SERIES), 0140 (DISP.), AS (MOUNTING/PORTING), 01(SHAFT), 0 (ROTATION), and AAAB (OPTION) shown in the left hand column of the chart.

**Caution:**

The charted component service information is for the Torqmotors listed only. Refer to the original equipment manufacturer of the equipment using the Torqmotor for assembly numbers not listed below.

EXPLODED VIEW												
SERIES	ITEM #	'5 & 6	7	9	11	'13	'14	'15	17	'19	20	25
	DESCRIPTION	COMMUTATOR ASSEMBLY	MANIFOLD (see note)	WEAR PLATE	THRUST BEARING	INNER BEARING	THRUST WASHER(2)	THRUST BEARING	BACKUP WASHER	OUTER BEARING	DIRT & WATER SEAL	BACKUP WASHER
TG-Service Part #	ME018000A1	ME015000	477342	068024	071031	400136	069017	028515	068027	478035	029118	

EXPLODED VIEW <sup>2</sup> (SELECT ITEM # BOLT PER OPTION GROUP)										
	ITEM #	1	or 1A	or 1B	or 1C	8A	8B	10		
DISPLACEMENT GROUP	DISPLACEMENT (in <sup>3</sup> /rev)	BOLT (7)	BOLT (7)	BOLT (7)	BOLT (7)	ROTOR THICKNESS	ROTOR SET	FREE RUNNING ROTOR SET	DRIVE LINK	DRIVE LINK "L DIM"
	0140-	8.6	021390	021273	021273	021379	.6286	ME097003	ME097007	ME093000
0170-	10.3	021376	021387	021387	021392	.7518	ME107003	ME107007	ME103000	4.5650
0195-	12.0	021352	021379	021379	021291	.8768	ME127003	ME127007	ME123000	4.6905
0240-	14.5	021272	021291	021291	021412	1.0643	ME157003	ME157007	ME153000	4.8795
0280-	17.1	021340	021392	021392	021385	1.2518	ME187003	ME187007	ME183000	5.0685
0310-		021340		021385		1.3738	ME197003	ME197007	ME193000	5.1935
0335-	20.6	021273	021385	021385	021366	1.5018	ME217003	ME217007	ME213000	5.3195
0405-	24.7	021379	021366	021415	021374	1.7923	ME247003	ME247007	ME243000	5.6045
0475-	29.1	021392	021394	021394	021393	2.1268	ME297003	ME297007	ME293000	5.9475
0530-	32.3	021385	021393	021393	021395	2.3768	ME337003	ME337007	ME333000	6.1985
0625-	38.0	021366	021329	021329	021458	2.7536	ME377003	N/A	ME373000	6.5745
0785-	48.0	021395	021388	021388	021416	3.5036	ME487003	N/A	ME483000	7.3285
0960-	58.5	021396	021389	021389	021399	4.2536	ME587003	N/A	ME583000	8.0815

FRONT PORTING	Mounting Code Porting Code	EXPLODED VIEW				SPEED SENSOR	
		ITEM #		'18	'18A	18	18
		DESCRIPTION MOUNTING	®PORTING	SERVICE HOUSING ASS'Y	O-RING (2)	SERVICE HOUSING ASS'Y	SENSOR
MS-	Standard (4 Bolt)	7/8" O-Ring	ME012001A3		ME012301A3	455069	
US-	Wheel Mt. (4 Bolt)	7/8" O-Ring	ME012002A3		ME012302A3	455069	
AS-	SAE A (2 Bolt)	7/8" O-Ring	ME012006A3		ME012306A3	455069	
BS-	SAE B (2 Bolt)	7/8" O-Ring	ME012019A3		ME012319A3	455069	
HS-	Wheel (US) with Machined Pilot Nose	7/8" O-Ring	ME012008A3				
AM-	SAE A (2 Bolt)	Manifold	ME012028A3	032790	ME012328A3	455069	
MM-	Standard (4 Bolt)	Manifold	ME012018A3	032790			
AT-	SAE A (2 Bolt)	1/2" BSPF	ME012027A3				
MT-	Standard (4 Bolt)	1/2" BSPF	ME012010A3		ME012310A3	455069	

HOUSING GROUP	Mounting Code Porting Code	EXPLODED VIEW					SPEED SENSOR	
		ITEM #		1, 1A, 1B, 1C	2	'18	18	18
		DESCRIPTION MOUNTING	®PORTING	BOLT	END COVER	SERVICE HOUSING ASS'Y	SERVICE HOUSING ASS'Y	SENSOR
MA-	Standard (4 Bolt)	Rear Port (7/8" O-Ring; Axial)	Item #1B	ME016009	ME012004A3			
UA-	Wheel Mt. (4 Bolt)	Rear Port (7/8" O-Ring; Axial)	Item #1B	ME016009	ME012005A3			
AA-	SAE A (2 Bolt)	Rear Port (7/8" O-Ring; Axial)	Item #1B	ME016009	ME012007A3	ME012307A3	455069	
WA-	Wheel, Optional (4 Bolt)	Rear Port (7/8" O-Ring; Axial)	Item #1B	ME016009	ME012011A3			
VA-	SAE A (4 Bolt)	Rear Port (7/8" O-Ring; Axial)	Item #1B	ME016009	ME012049A3			
MB-	Standard (4 Bolt)	Rear Port (7/8" O-Ring; Radial)	Item #1B	ME016002	ME012004A3			
UB-	Wheel Mt. (4 Bolt)	Rear Port (7/8" O-Ring; Radial)	Item #1B	ME016002	ME012005A3			
AB-	SAE A (2 Bolt)	Rear Port (7/8" O-Ring; Radial)	Item #1B	ME016002	ME012007A3	ME012307A3	455069	
WB-	Wheel, Optional (4 Bolt)	Rear Port (7/8" O-Ring; Radial)	Item #1B	ME016002	ME012011A3			
VB-	SAE A (4 Bolt)	Rear Port (7/8" O-Ring; Radial)	Item #1B	ME016002	ME012049A3			
ME-	Standard (4 Bolt)	Rear Port (Manifold; Radial)	Item #1B	ME016001J1	ME012004A3			
UE-	Wheel Mt. (4 Bolt)	Rear Port (Manifold; Radial)	Item #1B	ME016001J1	ME012005A3			
AE-	SAE A (2 Bolt)	Rear Port (Manifold; Radial)	Item #1B	ME016001J1	ME012007A3	ME012307A3	455069	
WE-	Wheel, Optional (4 Bolt)	Rear Port (Manifold; Radial)	Item #1B	ME016001J1	ME012011A3			
VE-	SAE A (4 Bolt)	Rear Port (Manifold; Radial)	Item #1B	ME016001J1	ME012049A3			



TG Service Parts List Chart

Torqmotor™ Service Procedure

TC, TS, TB, TE, TJ, TF, TG, TH and TL Series

EXPLODED VIEW		SPEED SENSOR							
ITEM #		12	12	12A	12B	12C	12D	12E	12F
	DESCRIPTION	COUPLING SHAFT	COUPLING SHAFT	KEY	NUT	WASHER	5/8-18 BOLT	LOCK WASHER	RETAINING RING
COUPLING SHAFT GROUP	01- Long 6B Snapwire Groove	ME019001	ME019301						
	02- Long Woodruff, 1/4" Tap Snapwire Groove	ME019002	ME019302	038015*					
	03- 1.25" Straight Keyed 5/8-18 Int. Thd.	ME019003	ME019303	039028		028413	021482	028992	401333
	04- 10B Spline	ME019004	ME019304						
	05- 14 Tooth Spline 5/8-18 Int. Thd.	ME019005	ME019305			028413	021482	028992	
	06- 19 Tooth Spline	ME019006							
	07- 15 Tooth Spline	ME019007							
	08- 1.25" Tapered Shaft	ME019000	ME019300	038016**	3025126				
	19- 1.38" Tapered 1.125-18 Thd.	ME019010		038016**	7025138				
	20- 1.38" Straight Key 5/8 Tap	ME019011	ME019311	039028		028518	021482	028992	401658

\*(1/4 x 1)

\*\* (5/16x1)

EXPLODED VIEW											
ITEM #		<sup>2</sup> 1, 1A, 1B, 1C	2	3	4	16	<sup>6</sup> 21 & 22	<sup>4,6</sup> 22	<sup>6</sup> 23	<sup>6</sup> 24	
	DESCRIPTION	BOLT (7)	END COVER	COMMUTATOR SEAL	INNER SEAL	PLUG & O-RING ASSEMBLY	O-RING	SPRING (2)	VALVE	SENSOR	
AAAA	Black Paint	Item #1	ME016000	032435	032819	032817					
AAAC	Corrosion Resistant Paint	Item #1	ME016000	032435	032819	032817					
AAAF	Castle Nut Replacing Patch Lock Nut	Item #1	ME016000	032435	032819	032817					
AAAG	Fluorocarbon Seals	Item #1	ME016000	032435	032820	032818					
AAAT	Bidirectional Shuttle Valve Endcover 11:00	Item #1A	<sup>6</sup> ME016003A1	032435	032819	032817	036297	032791	401642	415569	
AAAU	Bidirectional Shuttle Valve Endcover 11:00 & Castle Nut	Item #1A	<sup>6</sup> ME016003A1	032435	032819	032817	036297	032791	401642	415569	
BBBA	1000 PSI Cross Port Relief Endcover	Item #1C	<sup>6</sup> ME016004A1	032435	032819	032817	411063A1	032424		41001210(2), 1000 PSI	
BBBG	1500 PSI Cross Port Relief Endcover	Item #1C	ME016004A5	032435	032819	032817	411063A1	032424		41000976(2), 1500 PSI	
BBBB	2000 PSI Cross Port Relief Endcover	Item #1C	<sup>6</sup> ME016004A2	032435	032819	032817	411063A1	032424		41001220(2), 2000 PSI	
BBCG	2500 PSI Cross Port Relief Endcover	Item #1C	ME016004A6	032435	032819	032817	411063A1	032424		41001225(2), 2500 PSI	
BBBC	3000 PSI Cross Port Relief Endcover	Item #1C	<sup>6</sup> ME016004A3	032435	032819	032817	411063A1	032424		41001230(2), 3000 PSI	
BBBD	4000 PSI Cross Port Relief Endcover	Item #1C	<sup>6</sup> ME01604A4	032435	032819	032817	411063A1	032424		41001240(2), 4000 PSI	
FSAA	Speed Sensor Option	Item #1	ME016000	032435	032819	032817				455069	

For reverse timed manifold, use ME015001.

<sup>1</sup> Service housing ass'y ITEM #18 with part number suffix-A1 includes ITEM #13, #14 two req'd, #15 and #19.

<sup>2</sup> Select the required bolt number in designated "DISPLACEMENT GROUP" under bolt ITEM #1, 1A, 1B or 1C shown in designated "OPTION GROUP."

<sup>3</sup> 1-20 UNEF slotted nut #025113 is required on 1-1/4" tapered shaft if the designated "OPTION GROUP" is AAAF, AAAN, or AAAU.

<sup>4</sup> ITEM #22 is part of plug & o-ring ass'y's but can be serviced separately.

<sup>5</sup> Service end cover ME016001J1 includes two #032790 o-rings, ITEM 18A on the exploded ass'y view that can also be serviced separately.

<sup>6</sup> End cover assembly item #2 also includes item #21, #22, #24 and if required item #23. All but item #21 can be serviced separately.

<sup>7</sup> ME018001A1 commutator ass'y. is required if the designated "OPTION GROUP" is AAAM, AAAN, or AAAP.

<sup>8</sup> Order (2) #032790 seals for parts when ordering manifold-style porting.

Standard seal kit #SK000092 includes six #032819 seal rings, #032435 commutator seal, #032817 inner seal, #028515 and #029118 back washers, #478035 dirt & water seal, #406018 grease pack, bulletin #050016.

Special seal kit #SK000093 for units that use fire retardant fluids includes six #032820 seal rings, #032435 commutator seal, #032818 inner seal, #028515 and #029118 back up washers, #478035 dirt & water seal, #406018 grease pack, bulletin #050016.

Vespel commutator seal AAAJ #032439. High temp seal black in color.

(08) 1-1/4 Shaft zinc di chromate Castle Nut 1-20 #025139

(08) 1-1/4 Shaft Castle Nut 1-20 #025113

(19) 1-3/8 Shaft Zinc DiChromate Castle Nut 1-1/4-18 #025139



TH Service Parts List Chart

Torqmotor™ Service Procedure

TC, TS, TB, TE, TJ, TF, TG, TH and TL Series

Chart Use Example:

TH0140AS010AAAB Torqmotor™ includes part numbers listed to the right of TH (SERIES), 0140 (DISP), A (MOUNTING), S (PORTING), 31 (SHAFT), 0 (ROTATION), and AAAB (OPTION) shown in the left hand column of the chart.

Caution:

The charted component service information is for the Torqmotors listed only. Refer to the original equipment manufacturer of the equipment using the Torqmotor for assembly numbers not listed below.

EXPLODED VIEW												
SERIES	ITEM #	<sup>5</sup> & 6	7	9	11	<sup>13</sup>	<sup>14</sup>	<sup>15</sup>	17	<sup>19</sup>	20	25
	DESCRIPTION	COMMUTATOR ASSEMBLY	MANIFOLD (SEE NOTE)	WEAR PLATE	THRUST BEARING	INNER BEARING	THRUST WASHER(2)	THRUST BEARING	BACKUP WASHER	OUTER BEARING	DIRT & WATER SEAL	BACKUP WASHER
	TH-Service Part #	ME018000A1	ME015000	477342	068024	071031	069023 (2)	069022	028537	069021	478063	028538

EXPLODED VIEW <sup>2</sup> (SELECT ITEM # BOLT PER OPTION GROUP)											
DISPLACEMENT GROUP	ITEM #	1 OR 1A OR 1B OR 1C				8A	8B	10			
	DISPLACEMENT (in <sup>3</sup> /rev)	BOLT (7)	BOLT (7)	BOLT (7)	BOLT (7)	ROTOR THICKNESS	ROTOR SET	FREE RUNNING ROTOR SET	DRIVE LINK	DRIVE LINK "L DIM"	
	0140-	8.6	021390	021273	021273	021379	.6286	ME097003	ME097007	ME093000	4.4385
0170-	10.3	021376	021387	021387	021392	.7518	ME107003	ME107007	ME103000	4.5650	
0195-	12.0	021352	021379	021379	021291	.8768	ME127003	ME127007	ME123000	4.6905	
0240-	14.5	021272	021291	021291	021412	1.0643	ME157003	ME157007	ME153000	4.8795	
0280-	17.1	021340	021392	021392	021385	1.2518	ME187003	ME187007	ME183000	5.0685	
0335-	20.6	021273	021385	021385	021366	1.5018	ME217003	ME217007	ME213000	5.3195	
0405-	24.7	021379	021366	021415	021374	1.7923	ME247003	ME247007	ME243000	5.6045	
0475-	29.1	021392	021394	021394	021393	2.1268	ME297003	ME297007	ME293000	5.9475	
0530-	32.3	021385	021393	021393	021395	2.3768	ME337003	ME337007	ME333000	6.1985	
0625-	38.0	021366	021329	021329	021458	2.7536	ME377003	N/A	ME373000	6.5745	
0785-	48.0	021395	021388	021388	021416	3.5036	ME487003	N/A	ME483000	7.3285	
0960-	58.5	021396	021389	021389	021399	4.2536	ME587003	N/A	ME583000	8.0815	

FRONT PORTING	EXPLODED VIEW			
	Mounting Code	Porting Code	ITEM #	<sup>18</sup>
	DESCRIPTION	MOUNTING	PORTING	SERVICE HOUSING ASS'Y
MS-	SAE A (4 Bolt)		7/8" O-Ring	MJ012002A1
US-	Wheel Mt. (4 Bolt)		7/8" O-Ring	MJ012001A1
MM-	Standard Mt. (4 Bolt)		Manifold	MJ012014A1

HOUSING GROUP	EXPLODED VIEW					
	Mounting Code	Porting Code	ITEM #	1, 1A, 1B, 1C	2	<sup>18</sup>
	DESCRIPTION	MOUNTING	PORTING	BOLT	END COVER	SERVICE HOUSING ASS'Y
MA-	Standard Mount (4 Bolt)		Rear Port (7/8" O-Ring; Axial)	Item #1B	ME016009	MJ012004A1
UA-	Wheel Mt. (4 Bolt)		Rear Port (7/8" O-Ring; Axial)	Item #1B	ME016009	MJ012003A1
MB-	Standard Mount (4 Bolt)		Rear Port (7/8" O-Ring; Radial)	Item #1B	ME016002	MJ012004A1
UB-	Wheel Mt. (4 Bolt)		Rear Port (7/8" O-Ring; Radial)	Item #1B	ME016002	MJ012003A1
ME-	Standard Mount (4 Bolt)		Rear Port (Manifold; Radial)	Item #1B	ME016001J1	MJ012004A1
UE-	Wheel Mt. (4 Bolt)		Rear Port (Manifold; Radial)	Item #1B	ME016001J1	MJ012003A1
P*	SAE B (4 Bolt)		Rear Port Only			MJ012008A1
K*	SAE CC (4 Bolt)		Rear Port Only	Item #1B		MJ012019A1

COUPLING SHAFT GROUP	EXPLODED VIEW							
	ITEM #	12	12A	12B	12C	12D	12E	12F
	DESCRIPTION	COUPLING SHAFT	KEY	NUT	WASHER	7/8-14x1.250 BOLT	LOCK WASHER	RETAINING RING
19-	1 3/8" Tapered Shaft	MJ019011						
31-	1-1/2" Tapered Shaft	MJ019000		025131				
32-	1-1/2" Straight Key	MJ019001	039040* (3/8x1)		028492	021483	028966	401464
36-	17 Tooth Spline	MJ019002						
62-	14 Tooth Spline	MJ019007						
73-	17 Tooth Spline M12 Tap	MJ019009						



EXPLODED VIEW										
ITEM #		<sup>2</sup> 1, 1A, 1B, 1C	2	3	4	16	<sup>6</sup> 21 & 22	<sup>4,6</sup> 22	<sup>6</sup> 23	<sup>6</sup> 24
		END COMMUTATOR SEAL		INNER SEAL	PLUG & O-RING					
DESCRIPTION	BOLT (7)	COVER	SEAL	RING (5)	SEAL	ASSEMBLY	O-RING	SPRING (2)	VALVE	
AAAA	Black Paint	Item #1	ME016000	032435	032819	032836				
AAAC	Corrosion Resistant Paint	Item #1	ME016000	032435	032819	032836				
AAAF	Castle Nut Replacing Patch Lock Nut	Item #1	ME016000	032435	032819	032836				
AAAG	Viton Seals Black Paint	Item #1	ME016000	032435	032820	032836				
AAAH	Viton Seals No Paint	Item #1	ME016000	032435	032820	032836				
AAAT	Hot Oil Shuttle Endcover 11:00	Item #1A	<sup>6</sup> ME016003A1	032435	032819	032836	036297	032790	401642	415569
AAAU	Hot Oil Shuttle Endcover 11:00 & Castle Nut	Item #1A	<sup>6</sup> ME016003A1	032435	032819	032836	036297	032790	401642	415569
OPTION GROUP	BBBA	1000 PSI Cross Port Relief Endcover	Item #1C	<sup>6</sup> ME016004A1	032435	032819	032836	411063A1	032424	41001210 (2), 1000PSI
	BBBB	2000 PSI Cross Port Relief Endcover	Item #1C	<sup>6</sup> ME016004A2	032435	032819	032836	411063A1	032424	41001220 (2), 2000PSI
	BBBC	3000 PSI Cross Port Relief Endcover	Item #1C	<sup>6</sup> ME016004A3	032435	032819	032836	411063A1	032424	41001230 (2), 3000PSI
	BBBD	4000 PSI Cross Port Relief Endcover	Item #1C	<sup>6</sup> ME016004A4	032435	032819	032836	411063A1	032424	41001240 (2), 4000PSI
	BBBG	1500 PSI Cross Port Relief Endcover	Item #1C	ME016004A5	032435	032819	032836	411063A1	032424	41000976 (2), 1500PSI
	BBCG	2500 PSI Cross Port Relief Endcover	Item #1C	ME016004A6	032435	032819	032836	411063A1	032424	41001225 (2), 2500PSI

For reverse timed manifold, use MF015001.

<sup>1</sup> Service housing ass'y ITEM #18 with part number suffix-A1 includes ITEM #13, #14 two req'd, #15 and #19.

<sup>2</sup> Select the required bolt number in designated "DISPLACEMENT GROUP" under bolt ITEM #1, 1A, 1B or 1C shown in designated "OPTION GROUP."

<sup>3</sup> 1-20 UNEF slotted nut #025133 is required if the designated "OPTION GROUP" is AAAF, AAAN, or AAAU.

<sup>4</sup> ITEM #22 is part of plug & o-ring ass'y's but can be serviced separately.

<sup>5</sup> Service and cover ME016001J1 includes two #032790 o-rings, ITEM 18A on the exploded ass'y view that can also be serviced separately.

<sup>6</sup> End cover assembly item #2 also includes item #21, #22, #24 and if required item #23. All but item #21 can be serviced separately.

<sup>7</sup> ME018001A1 commutator ass'y. is required if the designated "OPTION GROUP" is AAAM, AAAN, or AAAP.

Standard seal kit #SK000115 includes six #032819 seal rings, #032435 commutator seal, #032836 inner seal, #028537 and #028538 backup washers, #478063 dirt & water, #406018 grease pack, bulletin #050016.

**Chart Use Example:**

TL0240US080AAAB Torqmotor™ includes part numbers listed to the right of TL (SERIES), 0240 (DISP.), US (MOUNTING/PORTING), 08 (SHAFT), 0 (ROTATION), and AAAB (OPTION) shown in the left hand column of the chart.

**Caution:**

The charted component service information is for the Torqmotors listed only. Refer to the original equipment manufacturer of the equipment using the Torqmotor for assembly numbers not listed below.

EXPLODED VIEW											
SERIES	ITEM #	5 & 6	7	11	'13	'14	'15	17	'19	20	25
	DESCRIPTION	COMMUTATOR ASSEMBLY	MANIFOLD (see note)	THRUST BEARING	INNER BEARING	THRUST WASHER(1)	THRUST BEARING	BACKUP WASHER	OUTER BEARING	DIRT & WATER SEAL	BACKUP WASHER
TL- Service Part #	ME018000A1	TL015000	068024	071031	400136	069017	028515	068027	478035	029118	

EXPLODED VIEW <sup>2</sup> (SELECT ITEM # BOLT PER OPTION GROUP)							
DISPLACEMENT GROUP	ITEM #	1	8A	10	9		
	DISPLACEMENT (in <sup>3</sup> /rev)	BOLT (7)	ROTOR THICKNESS	ROTOR SET	DRIVE LINK	DRIVE LINK "LENGTH"	WEAR PLATE
	0140-	8.6	021111	.6271	TL097003	TL123000	3.414
0195-	12.0	021270	.8768	TL127003	TL123000	3.414	477342
0240-	14.5	021111	1.0643	TL157003	TL153000	3.597	477342
0280-	17.1	021326	1.2518	TL187003	TL183000	3.760	477342

FRONT PORTING	EXPLODED VIEW				
	Mounting Code	ITEM #	'18	2	
	Porting Code	DESCRIPTION	SERVICE HOUSING ASS'Y	REAR COVER	
US-	Wheel Mt. (4 Bolt)		7/8" O-Ring	TL012000A1	TL016000
LS-	Wheel Mt. Front Brake Nose		7/8" O-Ring	TL012001A1	TL016000
UB-	Wheel Mt. (4 Bolt)		7/8" Rear Radial	TL012002A1	ME016002

EXPLODED VIEW										
COUPLING SHAFT GROUP	ITEM #	12	12A	12B	12C	12D	12E	12F		
	DESCRIPTION	COUPLING SHAFT			KEY	NUT	WASHER	5/8-18 BOLT	LOCK WASHER	RETAINING RING
	08-	1.25" Tapered Shaft	TL019000	038016*(1/4 x 1.00)	<sup>3</sup> 025126					
03-	1.25" Str. Keyed 5/8-18 Int. Thd.	TL019003								

EXPLODED VIEW						
OPTION GROUP	ITEM #	<sup>2</sup> 1, 1A, 1B, 1C	2	3	4	16
	DESCRIPTION	BOLT (7)	END COVER	COMMUTATOR SEAL	SEAL RING (6)	INNER SEAL
	AAWM	Black Paint	Item #1	TL016000	032439	032819
AAWL	No Paint	Item #1	TL016000	032439	032819	032818

Shaft seal #16, can be replaced without replacing back up ring, #17, or backup washer, #25. Inspect items #17 and #25 to be sure wear or corrosion has not affected these parts. If not, remove the old shaft seal, noting position and direction of seal lip. To replace the new shaft seal, use only fingers (tools not required) and replace the seal from the rear of the motor.

If corrosion or wear is a problem and item #17 and #25 must be replaced, the factory recommends replacing the entire housing assembly (TL012xxx0A1).

For reverse timed manifold, use TL015001.

<sup>1</sup> Service housing assembly ITEM #18 with part number suffix-A1 includes ITEM #13, #14, #14, #16, #17, #18, #19, #20 & #25.

<sup>2</sup> Select the required bolt number in designated "DISPLACEMENT GROUP" under bolt ITEM #1, 1A, 1B or 1C shown in designated "OPTION GROUP."

<sup>3</sup> 1-20 UNEF slotted nut #025113 is required on 1-1/4" tapered shaft if the designated "OPTION GROUP" is AAFA, AAAN, or AAAU.

Standard seal kit #SK000212 includes six #032819 seal rings (buna), #032439 vespel commutator seal, #032818 inner seal fluorocarbon and #478035 dirt & water seal, 406018 grease pack and bulletin #050073.

Shaft nuts are zinc dichromate.



## Preparation Before Disassembly

- Before you disassemble the Torqmotor™ unit or any of its components read this entire manual. It provides important information on parts and procedures you will need to know to service the Torqmotor™.
- Determine whether the Torqmotor™ you are about to disassemble is the Small Frame Series TC, TS, TB, TE or TJ or the Large Frame Series TF, TG, TL or TH so you can follow those procedures that pertain to that Series Torqmotor™. The first two letters of the “spec” number on the Torqmotor™ identification tag is the Series designation. Also determine the type of end construction from the alternate views shown on the exploded view.
- The Small Frame Series TC, TS, TB & TE Torqmotors™ will have a 3.66 inch (92.9 mm) main body outside diameter and five or six 5/16-24 UNF 2A cover bolts. The Medium Frame Series TJ Torqmotors™ will have a 3.66 inch (92.9 mm) main body outside diameter and six 5/16-24 UNF 2A cover bolts. The Large Frame Series TF, TG, TL & TH Torqmotors™ will have a 5 inch (127.9 mm) main body outside diameter and seven 3/8 24 UNF 2A cover bolts.
- Refer to “Tools and Materials Required for Services” section for tools and other items required to service the Torqmotor™ and have them available.
- Thoroughly clean off all outside dirt, especially from around fittings and hose connections, before disconnecting and removing the Torqmotor™. Remove rust or corrosion from coupling shaft.
- Remove coupling shaft connections and hose fittings and immediately plug port holes and fluid lines.
- Remove the Torqmotor™ from system, drain it of fluid and take it to a clean work surface.
- Clean and dry the Torqmotor™ before you start to disassemble the unit.
- As you disassemble the Torqmotor™ clean all parts, except seals, in clean petroleum-based solvent, and blow them dry.

**WARNING:** petroleum-base solvents are flammable. Be extremely careful when using any solvent. Even a small explosion or fire could cause injury or death.

**WARNING:** WEAR EYE PROTECTION AND BE SURE TO COMPLY WITH OSHA OR OTHER MAXIMUM AIR PRESSURE REQUIREMENTS.

**CAUTION:** Never steam or high pressure wash hydraulic components. Do not force or abuse closely fitted parts.

- Keep parts separate to avoid nicks and burrs.
- Discard all seals and seal rings as they are removed from the Torqmotor™. Replace all seals, seal rings and any damaged or worn parts with genuine Parker or OEM approved service parts.

## Reference Exploded Assembly View

### Place Torqmotor in a vise

1. Place the Torqmotor™ in a soft jawed vice, with coupling shaft (12) pointed down and the vise jaws clamping firmly on the sides of the housing (18) mounting flange or port bosses. Remove manifold port O-Rings (18A) if applicable.

### WARNING

**WARNING:** IF THE TORQMOTOR™ IS NOT FIRMLY HELD IN THE VISE, IT COULD BE DISLODGED DURING THE SERVICE PROCEDURES, CAUSING INJURY.

### Scribe alignment mark & loose valve plugs

2. Scribe an alignment mark down and across the Torqmotor™ components from end cover (2) to housing (18) to facilitate reassembly orientation where required. Loosen two shuttle or relief valve plugs (21) for disassembly later if included in end cover. 3/16 or 3/8 inch Allen wrench or 1 inch hex socket required. SEE FIGURES 3 & 4.

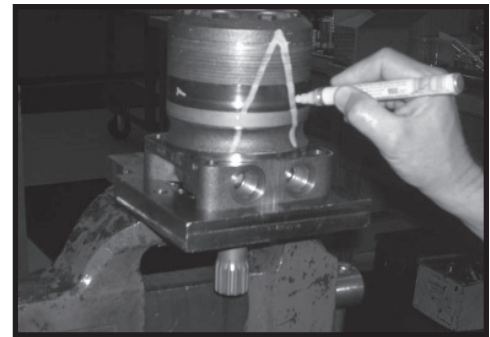

Figure 3

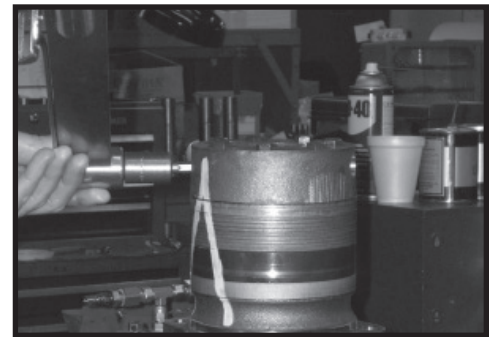

Figure 4

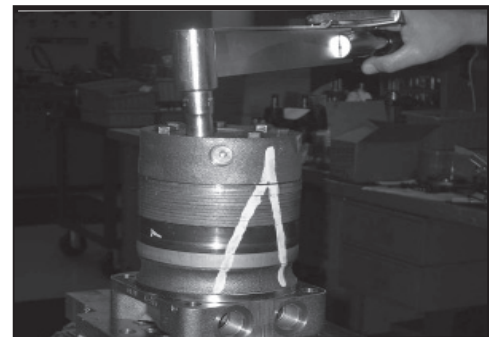

Figure 5

### Remove special bolts & inspect bolts

3. Remove the five, six, or seven special ring head bolts (1, 1A, 1B, or 1C) using an appropriate 1/2 or 9/16 inch size socket. SEE FIGURE 5. Inspect bolts for damaged threads, or sealing rings, under the bolt head. Replace damaged bolts. SEE FIGURE 6.



Figure 6

**Remove end cover & inspect bolts**

4. Remove end cover assembly (2) and seal ring (4). Discard seal ring. SEE FIGURE 7.

**NOTE**

**NOTE: Refer to the appropriate “alternate cover construction” on the exploded view to determine the end cover construction being serviced.**

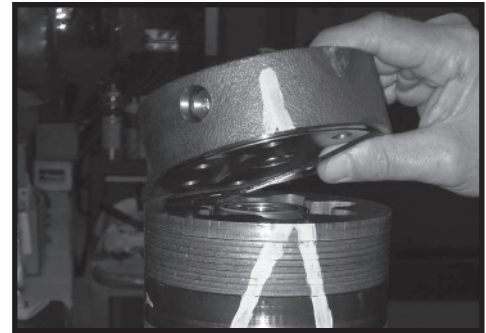

Figure 7

**Remove plugs and valves**

5. If the end cover (2) is equipped with shuttle valve or relief valve (24) components, remove the two previously loosened plugs (21) and o-rings (22). SEE FIGURE 8.

**CAUTION**

**CAUTION: Be ready to catch the shuttle valve or relief valve components that will fall out of the end cover valve cavity when the plugs are removed.**

**NOTE**

**NOTE: O-ring (22) is not included in seal kits but serviced separately if required.**

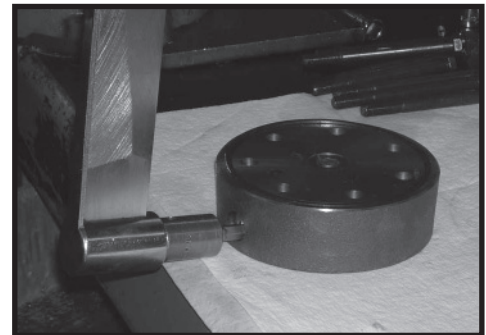

Figure 8

**NOTE**

**NOTE: The insert and if included the orifice plug in the end cover (2) must not be removed as they are serviced as an integral part of the end cover.**

**Wash & inspect end cover**

6. Thoroughly wash end cover (2) in proper solvent and blow dry. Be sure the end cover valve apertures, including the internal orifice plug, are free of contamination. Inspect end cover for cracks and the bolt head recesses for good bolt head sealing surfaces. Replace end cover as necessary. SEE FIGURE 9.

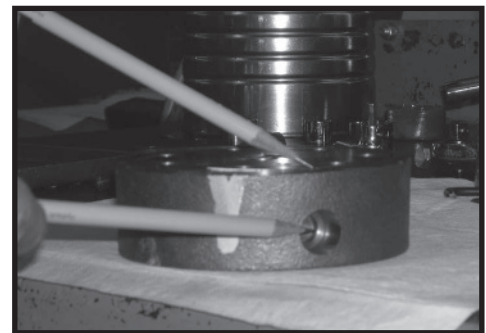

Figure 9

**NOTE**

**NOTE: A polished pattern (not scratches) on the cover from rotation of the commutator (5) is normal. Discoloration would indicate excess fluid temperature, thermal shock, or excess speed and require system investigation for cause and close inspection of end cover, commutator, manifold, and rotor set.**

**Remove & inspect commutator ring**

7. Remove commutator ring (6). SEE FIGURE 10. Inspect commutator ring for cracks, or burrs.

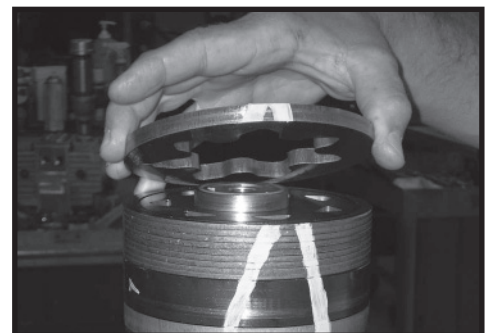

Figure 10



**Remove & inspect commutator**

8. Remove commutator (5) and seal ring (3) Remove seal ring from commutator, using an air hose to blow air into ring groove until seal ring is lifted out and discard seal ring. Inspect commutator for cracks or burrs, wear, scoring, spalling or brinelling. If any of these conditions exist, replace commutator and commutator ring as a matched set. SEE FIGURE 11 & 12.

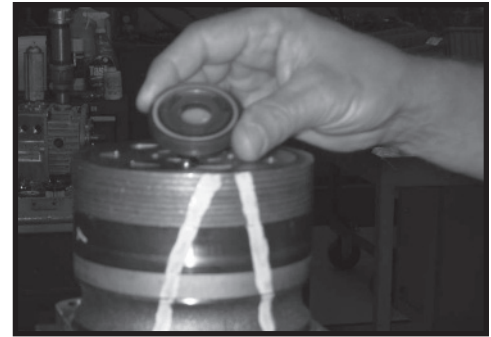

Figure 11

**Remove manifold**

9. Remove manifold (7) and inspect for cracks surface scoring, brinelling or spalling. Replace manifold if any of these conditions exist. SEE FIGURE 13. A polished pattern on the ground surface from commutator or rotor rotation is normal. Remove and discard the seal rings (4) that are on both sides of the manifold.



Figure 12

**NOTE**

**NOTE: The manifold is constructed of plates bonded together to form an integral component not subject to further disassembly for service. Compare configuration of both sides of the manifold to ensure that same surface is reassembled against the rotor set.**

**Remove & inspect rotor set & wearplate**

10. Remove rotor set (8) and wearplate (9), together to retain the rotor set in its assembled form, maintaining the same rotor vane (8C) to stator (8B) contact surfaces. SEE FIGURE 14. The drive link (10) may come away from the coupling shaft (12) with the rotor set, and wearplate. You may have to shift the rotor set on the wearplate to work the drive link out of the rotor (8A) and wearplate. SEE FIGURE 15. Inspect the rotor set in its assembled form for nicks, scoring, or spalling on any surface and for broken or worn splines. If the rotor set component requires replacement, the complete rotor set must be replaced as it is a matched set. Inspect the wearplate for cracks, brinelling, or scoring. Discard seal ring (4) that is between the rotor set and wearplate.

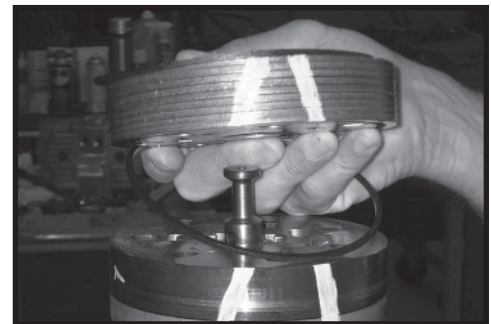

Figure 13

**NOTE**

**NOTE: The rotor set (8) components may become disassembled during service procedures. Marking the surface of the rotor and stator that is facing UP, with etching ink or grease pencil before removal from Torqmotor™ will ensure correct reassembly of rotor into stator and rotor set into Torqmotor™. Marking all rotor components and mating spline components for exact repositioning at assembly will ensure maximum wear life and performance of rotor set and Torqmotor™.**

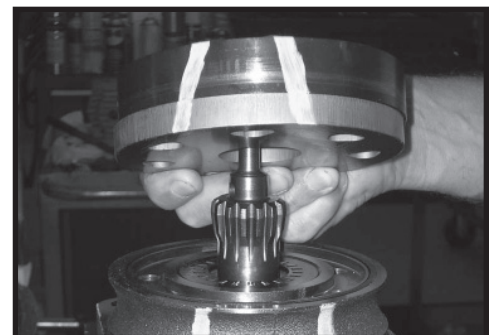

Figure 14

**NOTE**

**NOTE:** Series TG or TH may have a rotor set with two stator halves (8B & 8D) with a seal ring (4) between them and two sets of seven vanes (8C & 8E). Discard seal ring only if stator halves become disassembled during the service procedures.



Figure 15

**NOTE**

**NOTE:** A polished pattern on the wear plate from rotor rotation is normal.

**Check rotor, vane clearance**

- Place rotor set (8) and wear plate (9) on a flat surface and center rotor (8A) in stator (8B) such that two rotor lobes (180 degrees apart) and a roller vane (8C) centerline are on the same stator centerline. Check the rotor lobe to roller vane clearance with a feeler gage at this common centerline. If there is more than .005 inches (0.13 mm) of clearance, replace rotor set. SEE FIGURE 16.

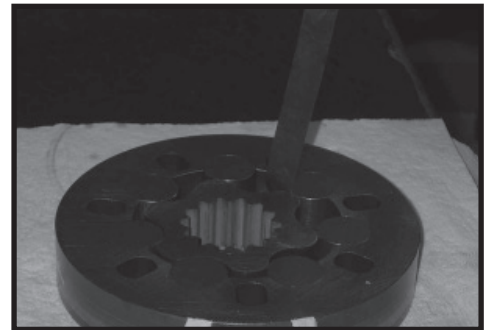

Figure 16

**NOTE**

**NOTE:** If rotor set (8) has two stator halves (8B & 8D) and two sets of seven vanes (8C & 8E) as shown in the alternate construction TG rotor set assembly view, check the rotor lobe to roller vane clearance at both ends of rotor.

**Remove & inspect drive link**

- Remove drive link (10) from coupling shaft (12) if it was not removed with rotor set and wear plate. Inspect drive link for cracks and worn or damaged splines. No perceptible lash (play) should be noted between mating spline parts. SEE FIGURE 17. Remove and discard seal ring (4) from housing (18).

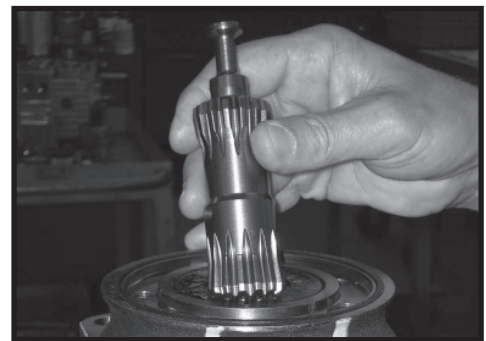

Figure 17

**Remove thrust bearing**

- Remove thrust bearing (11) from top of coupling shaft (12) if Torqmotor is a Series TF, TG, TH or TL. Inspect for wear, brinelling, corrosion and a full complement of retained rollers. SEE FIGURE 18.

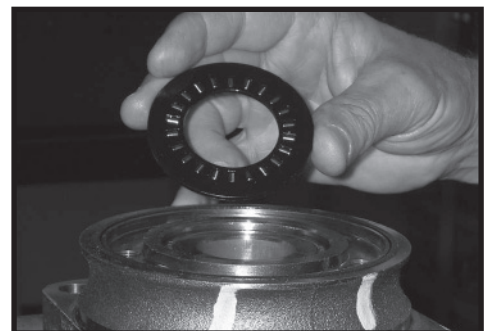

Figure 18

**Check coupling shaft for rust or corrosion**

14. Check exposed portion of coupling shaft (12) to be sure you have removed all signs of rust and corrosion which might prevent its withdrawal through the seal and bearing. Crocus cloth or fine emery paper may be used. SEE FIGURE 19. Remove any key (12A), nut (12B), washer (12C), bolt (12D), lock washer (12E), or retaining ring (12F).

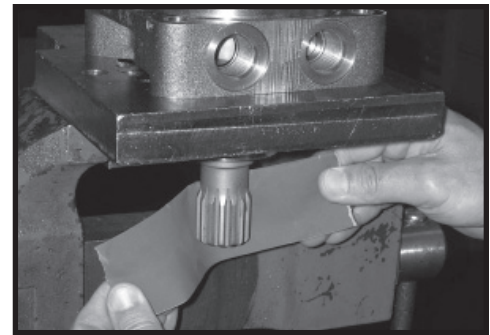

Figure 19

**Remove & inspect coupling shaft**

15. Remove coupling shaft (12), by pushing on the output end of shaft. SEE FIGURE 20. Inspect coupling shaft bearing and seal surfaces for spalling, nicks, grooves, severe wear or corrosion and discoloration. Inspect for damaged or worn internal and external splines or keyway. SEE FIGURE 21. Replace coupling shaft if any of these conditions exist.



Figure 20

**NOTE**

**NOTE: Minor shaft wear in seal area is permissible. If wear exceeds .020 inches (0.51 mm) diametrically, replace coupling shaft.**

**NOTE**

**NOTE: A slight "polish" is permissible in the shaft bearing areas. Anything more would require coupling shaft replacement.**

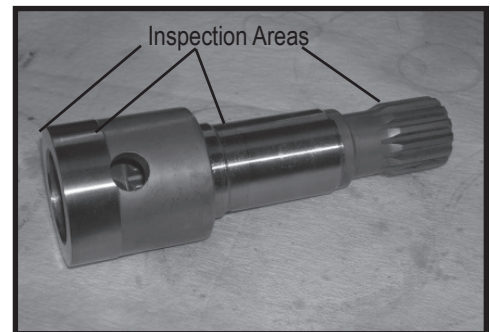

Figure 21

**Remove seal ring from housing**

16. Remove and discard seal ring (4) from housing (18).

**Remove & inspect thrust washer & thrust bearing**

17. Remove thrust bearing (15) and thrust washer (14) if the unit is a Series TC, TS, TB or TE. Inspect for wear, brinelling, corrosion and a full complement of retained rollers. SEE FIGURE 22. **Note: The TL motor has only one thrust bearing and washer.**

**NOTE**

**NOTE: Large Frame Series TF, TG & TJ Torqmotors have a thrust bearing (15) sandwiched between two thrust washers (14) that cannot be removed from housing (18) unless bearing (13) is removed for replacement.**



Figure 22

**Remove seal & washer or washers**

18. Remove seal (16) and back up ring (17) from Small Frame, TC, TB & TE housing (18) and backup washer (25). Discard both. SEE FIGURE 23.

Remove seal (16), backup ring (17), and backup washer (25) from Large Frame, Series TF, TG, TJ and TH housing by working them around unseated thrust washers (14) and thrust bearing (15) and out of the housing. Discard seal and washers. SEE FIGURE 24.



Figure 23

**NOTE**

**NOTE: The original design units of Large & Small Frame Torqmotors™ did not include backup washer (25), but must include backup washer (25) when reassembled for service.**



Figure 24

**Remove seal**

19. Remove housing (18) from vise, invert it and remove and discard seal (20). A blind hole bearing or seal puller is required. SEE FIGURE 25.



Figure 25

**Inspect housing assembly**

20. Inspect housing (18) assembly for cracks, the machined surfaces for nicks, burrs, brinelling or corrosion. Remove burrs that can be removed without changing dimensional characteristics. Inspect tapped holes for thread damage. SEE FIGURE 26. If the housing is defective in these areas, discard the housing assembly.

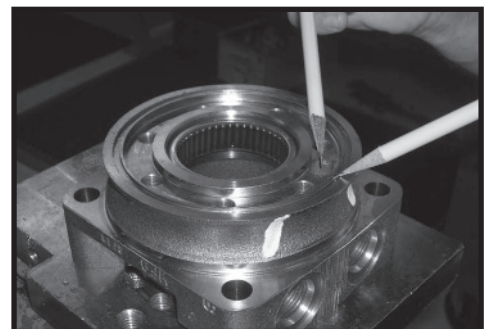

Figure 26

**Inspect housing bearing/bushing**

21. If the housing (18) assembly has passed inspection to this point, inspect the housing bearings/bushings (19) and (13) and if they are captured in the housing cavity the two thrust washers (14) and thrust bearing (15). The bearing rollers must be firmly retained in the bearing cages, but must rotate and orbit freely. All rollers and thrust washers must be free of brinelling and corrosion. SEE FIGURE 27. The TB Series bushing (19) or (13) to coupling shaft diameter clearance must not exceed .010 inch (.025 mm). A bearing, bushing, or thrust washer that does not pass inspection must be replaced. SEE FIGURE 28. If the housing has passed this inspection the disassembly of the Torqmotor™ is completed.

**NOTE**

**NOTE: The depth or location of bearing/bushing (13) in relation to the housing wear plate surface and the depth or location of bearing/bushing (19) in relation to the beginning of bearing/bushing counter bore should be measured and noted before removing the bearings/bushings. This will facilitate the correct reassembly of new bearings/bushings. SEE FIGURE 29.**

**Remove bearings or bushings & thrust washers**

22. If the bearings, bushing or thrust washers must be replaced use a suitable size bearing puller to remove bearing/bushings (19) and (13) from housing (18) without damaging the housing. Remove thrust washers (14) and thrust bearing (15) if they were previously retained in the housing by bearing (13). SEE FIGURES 30 & 31.

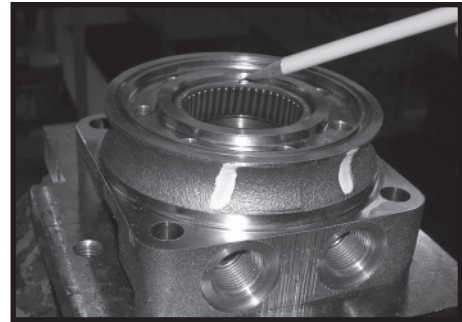

Figure 27

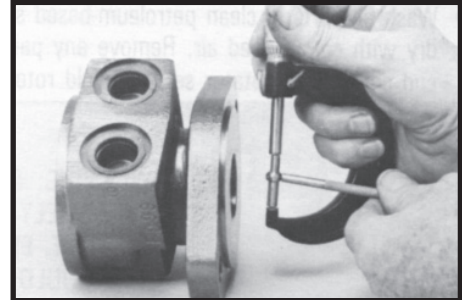

Figure 28

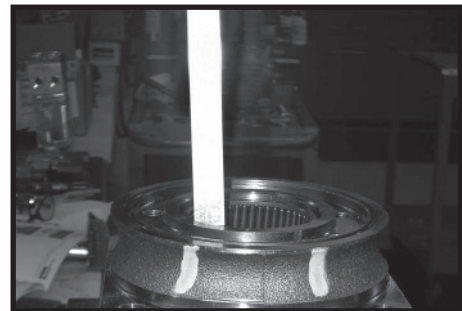

Figure 29

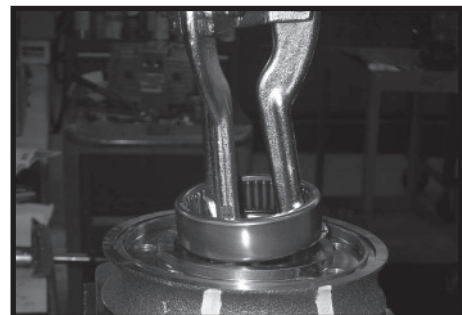

Figure 30



Figure 31

THE DISASSEMBLY OF TORQMOTOR™ IS COMPLETED.

- Replace all seals and seal rings with new ones each time you reassemble the Torqmotor™ unit. Lubricate all seals and seal rings with SAE 10W40 oil or clean grease before assembly.
- **NOTE: Individual seals and seal rings as well as a complete seal kit are available. SEE FIGURE 32. The parts should be available through most OEM parts distributors or Parker approved Torqmotor™ distributors. (Contact your local dealer for availability).**
- **NOTE: Unless otherwise indicated, do not oil or grease parts before assembly.**
- Wash all parts in clean petroleum-based solvents before assembly. Blow them dry with compressed air. Remove any paint chips from mating surfaces of the end cover, commutator set, manifold rotor set, wear plate and housing and from port and sealing areas.

**WARNING**

**WARNING: SINCE THEY ARE FLAMMABLE, BE EXTREMELY CAREFUL WHEN USING ANY SOLVENT. EVEN A SMALL EXPLOSION OR FIRE COULD CAUSE INJURY OR DEATH.**

**WARNING**

**WARNING: WEAR EYE PROTECTION AND BE SURE TO COMPLY WITH OSHA OR OTHER MAXIMUM AIR PRESSURE REQUIREMENTS.**

**Press in outer bearing/bushing**

1. If the housing (18) bearing components were removed for replacement, thoroughly coat and pack a **new** outer bearing/bushing (19) with clean corrosion resistant grease recommended in the material section. Press the new bearing/bushing into the counterbore at the mounting flange end of the housing, using the appropriate sized bearing mandrel such as described in figure 1 or figure 2 which will control the bearing/ bushing depth.

Small Frame Series TC, TS, TB and TE Torqmotor™ housings require the use of bearing mandrel shown in figure 1 to press bearing/ bushing (19) into the housing to a required depth of .151/.161 inches (3.84/4.09 mm) from the end of the bearing counterbore. SEE FIGURE 33. (TC reference page 10).

Large Frame Series TF, TL, TG & TJ Torqmotor™ housings require the use of the bearing mandrel shown in figure 2 to press bearing (19) into the housing to a required depth of .290/.310 inches (7.37/7.87 mm) from the outside end of the bearing counterbore. SEE FIGURE 34.

Large Frame Series TH Torqmotor housings require the use of a bearing mandrel. Consult factory for specifications.

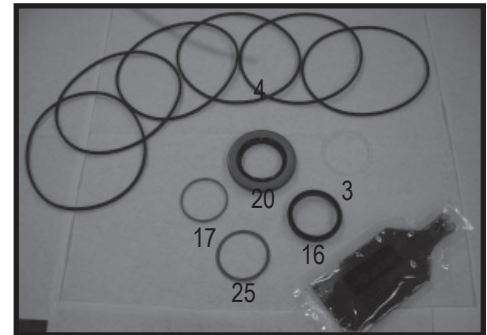

Figure 32, TF, TG seal kit

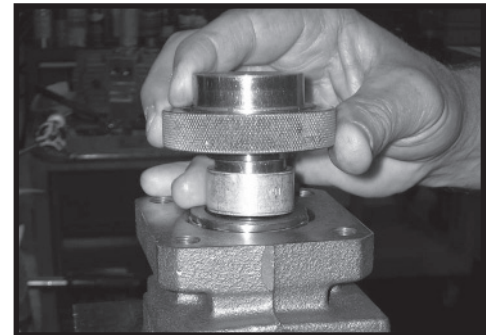

Figure 33

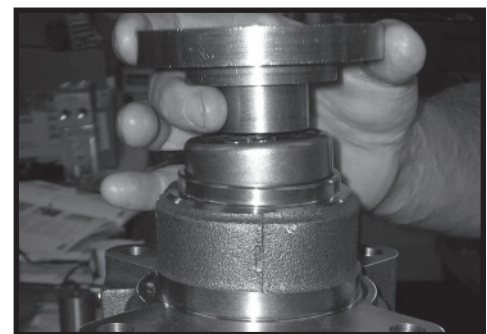

Figure 34

**NOTE**

**NOTE:** Bearing mandrel must be pressed against the lettered end of bearing shell. Take care that the housing bore is square with the press base and the bearing/bushing is not cocked when pressing a bearing/bushing into the housing.

**CAUTION**

**CAUTION:** If the bearing mandrel specified in the “Tools and Materials Required for Servicing” section is not available and alternate methods are used to press in bearing/bushing (13) and (19) the bearing/bushing depths specified must be achieved to insure adequate bearing support and correct relationship to adjacent components when assembled. SEE FIGURE 35.

**CAUTION**

**CAUTION:** Because the bearing/bushings (13) and (19) have a press fit into the housing they must be discarded when removed. They must not be reused.

**Press in inner bearing/bushing**

- The Small Frame Series TC, TB, TS and TE Torqmotor™ inner housing bearing/bushing (13) can now be pressed into its counter-bore in housing (18) flush to .03 inch (.76 mm) below the housing wear plate contact face. Use the opposite end of the bearing mandrel that was used to press in the outer bearing/bushing (19). Reference figure 1, “Tools and Materials Required for Servicing” section. SEE FIGURE 36.

The Large Frame Series TF, TL, TG & TJ Torqmotor™ housing (18) requires that you assemble a **new** backup washer (25) & backup ring (17), **new** seal (16), with the lip facing to the inside of Torqmotor (see figure 69A), **new** thrust washer (14), **new** thrust bearing (15) and a **new** second thrust washer (14) in that order before pressing in the inner housing bearing (13). SEE FIGURE 37 & 38. When these components are in place, press **new** bearing (13) into the housing (18) to a depth of .105/.125 inches (2.67/3.18), .03 inches max for TJ (.76) below the housing wear plate contact face. Use the opposite end of the bearing mandrel used to press in outer bearing (19). Reference figure 2, in the “Tools and Materials Required for Servicing” section. SEE FIGURE 39.

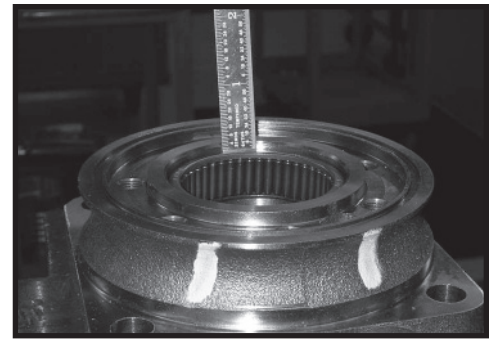

Figure 35

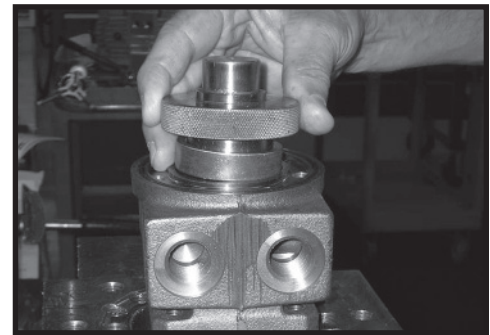

Figure 36



Figure 37



Figure 38

**Press in dirt & water seal**

3. Press a **new** dirt and water seal (20) into the housing (18) outer bearing counterbore.



Figure 39

The Small Frame Series TC, TS, TB and TE Torqmotor™ dirt and water seal (20) must be pressed in until its' flange is flush against the housing. SEE FIGURE 40.

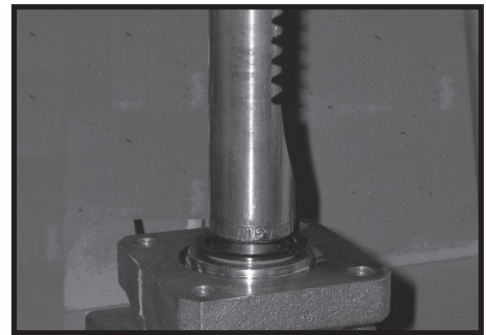

Figure 40

The Large Frame Series TF, TL, TG, TJ & TH Torqmotor™ dirt and water seal (20) must be pressed in with the lip facing out and until the seal is flush to .020 inches (.51 mm) below the end of housing. SEE FIGURE 41.

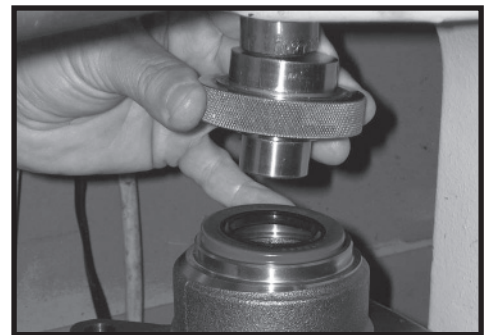

Figure 41

**Place housing assembly into vice**

4. Place housing (18) assembly into a soft jawed vise with the coupling shaft bore down, clamping against the mounting flange. SEE FIGURE 42.

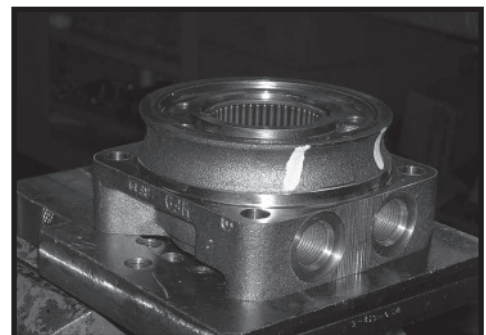

Figure 42



**Assemble backup washer & seal** 5. On Small Frame, Series TC, TS, TB & TE Torqmotors™ assemble a **new** backup ring (17), new backup washer (25) and **new** seal (16) with the seal lip facing toward the inside of Torqmotor™ (see Figure 69B), into their respective counterbores in housing (18) if they were not assembled in procedure 2.

Large Frame, Series TF, TG, TJ & TH Torqmotor™ housing (18) that did not require replacement of the bearing package will require that the two “captured” thrust washers (14) and thrust bearing (15) be unseated and vertical to the counterbore and the **new** backup ring (17), **new** backup washer (25), and **new** seal (16) be worked around the thrust bearing package and placed into their respective counterbores. The seal lip must face out of the seal counterbore and toward the inside of Torqmotor™ (see figure 69A). Be sure the thrust bearing package is resealed correctly after assembly of the seal and backup washer. SEE FIGURES 43 & 44.

**CAUTION**

**CAUTION: Original design Large Frame, TF & TG Torqmotors™ that do not have backup washer (25) when disassembled must be assembled with a new backup ring (17), new backup washer (25), and new seal (16).**

**Assemble thrust washer & bearing** 6. Assemble thrust washer (14) then thrust bearing (15) that was removed from the Series TC, TB, TS or TE Torqmotor™. SEE FIGURE 45.

**NOTE**

**NOTE: Small Frame Series TC, TS, TB and TE Torqmotors™ require one thrust washer (14) with thrust bearing (15). The coupling shaft will be seated directly against the thrust bearing.**

**Apply masking tape to shaft** 7. Apply masking tape around splines or keyway on shaft (12) to prevent damage to seal. SEE FIGURE 46.



Figure 43

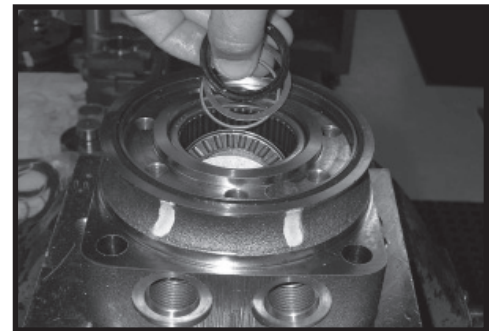

Figure 44



Figure 45

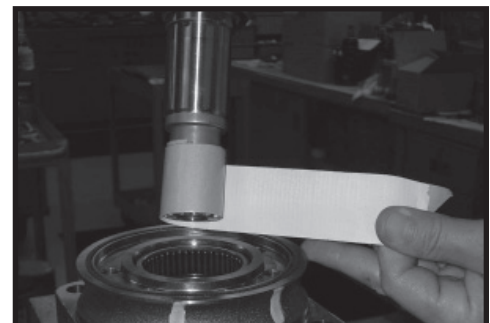

Figure 46

**Install coupling shaft**

- Be sure that a generous amount of clean corrosion resistant grease has been applied to the lower (outer) housing bearing/bushing (19). Install the coupling shaft (12) into housing (18), seating it against the thrust bearing (15) in TC, TS, TB and TE Series housings and against the second thrust washer (14) in TF, TL, TG and TH Series housings. SEE FIGURE 47.

**CAUTION**

**CAUTION:** The outer bearing (19) is not lubricated by the system's hydraulic fluid. Be sure it is thoroughly packed with the recommended grease, Parker Gear grease specification #045236, E/M Lubricant #K-70M.

**NOTE**

**NOTE:** Mobil Mobilith SHC ® 460  
**NOTE:** A 102 Tube (P/N 406010) is included in each seal kit.

**NOTE**

**NOTE:** The coupling shaft (12) will be flush or just below the housing wear surface on Small Frame, Series TC, TS, TB, TE & TJ Torqmotors™ when properly seated while the coupling shaft (12) on Large Frame, Series TF, TL, TG, or TH Torqmotors™ will be approximately .10 inch (2.54 mm) below the housing wear plate surface to allow the assembly of thrust bearing (11). The coupling shaft must rotate smoothly on the thrust bearing package. SEE FIGURE 48.

**Install thrust bearing**

- Install thrust bearing (11) onto the end of coupling shaft (12) only if you are servicing an TF, TL, TG, TH or TL Series Torqmotor™. SEE FIGURE 49.

**Insert seal ring**

- Apply a small amount of clean grease to a new seal ring (4) and insert it into the housing (18) seal ring groove. SEE FIGURE 50.

**NOTE**

**NOTE:** One or two alignment studs screwed finger tight into housing (18) bolt holes, approximately 180 degrees apart, will facilitate the assembly and alignment of components as required in the following procedures. The studs can be made by cutting off the heads of either 3/8-24 UNF 2A or 5/16-24 UNF 2A bolts as required that are over .5 inch (12.7 mm) longer than the bolts (1, 1A, 1B, or 1C) used in the Torqmotor™.

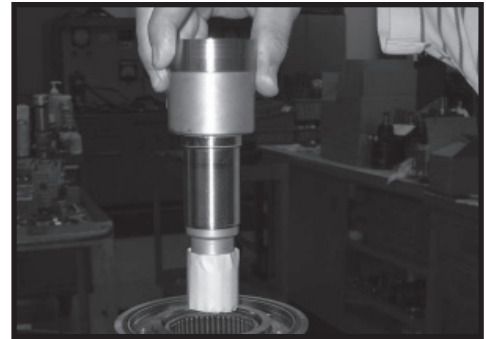

Figure 47

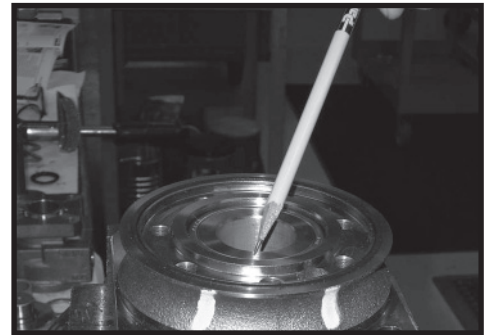

Figure 48



Figure 49

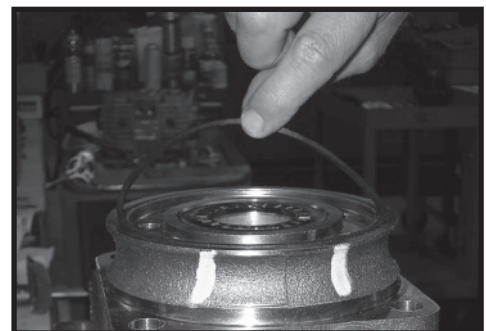

Figure 50

**Install drive link**

11. Install drive link (10) the long splined end down into the coupling shaft (12) and engage the drive link splines into mesh with the coupling shaft splines. SEE FIGURE 51.

**NOTE**

**NOTE: Use any alignment marks put on the coupling shaft and drive link before disassembly to assemble the drive link splines in their original position in the mating coupling shaft splines.**

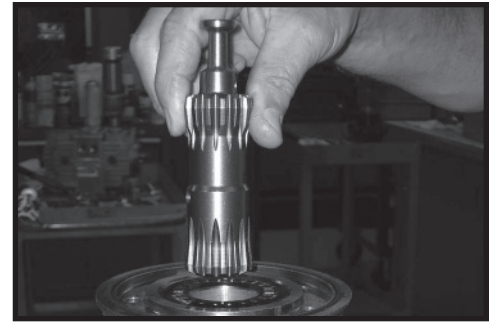

Figure 51

**Assemble wear plate**

12. Assemble wear plate (9) over the drive link (10) and alignment studs onto the housing (18). SEE FIGURE 52.

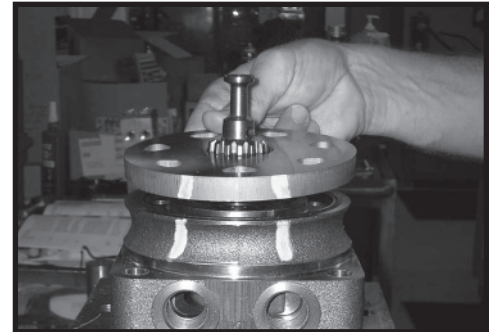

Figure 52

**Assemble seal ring**

13. Apply a small amount of clean grease to a new seal ring (4) and assemble it into the seal ring groove on the wear plate side of the rotor set stator (8B). SEE FIGURE 53.

**Install the assembled rotor set**

14. Install the assembled rotor set (8) onto wear plate (9) with rotor (8A) counterbore and seal ring side down and the splines into mesh with the drive link splines. SEE FIGURE 54.

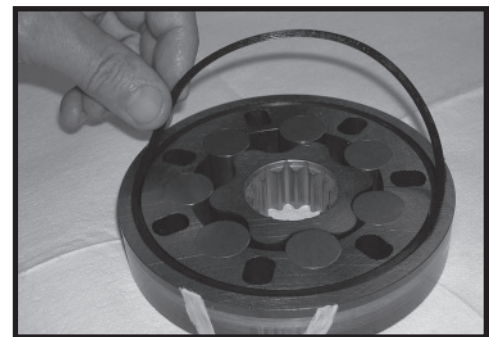

Figure 53

**NOTE**

**NOTE: It may be necessary to turn one alignment stud out of the housing (18) temporarily to assemble rotor set (8) or manifold (7) over the drive link.**

**NOTE**

**NOTE: If necessary, go to the appropriate, "Rotor Set Component Assembly Procedure."**

**NOTE**

**NOTE: The rotor set rotor counterbore side must be down against wear plate for drive link clearance and to maintain the original rotor-drive link spline contact. A rotor set without a counterbore and that was not etched before disassembly can be reinstalled using the drive link spline pattern on the rotor splines if apparent, to determine which side was down. The rotor set seal ring groove faces toward the wear plate (9).**



Figure 54

**Assemble seal ring in manifold**

15. Apply clean grease to a **new** seal ring (4) and assemble it in the seal ring groove in the rotor set contact side of manifold (7). SEE FIGURE 55.

**NOTE**

**NOTE:** The manifold (7) is made up of several plates bonded together permanently to form an integral component. The manifold surface that must contact the rotor set has it's series of irregular shaped cavities on the largest circumference or circle around the inside diameter. The polished impression left on the manifold by the rotor set is another indication of which surface must contact the rotor set.

**Assemble manifold**

16. Assemble the manifold (7) over the alignment studs and drive link (10) and onto the rotor set. Be sure the correct manifold surface is against the rotor set. SEE FIGURE 56.

**Insert a seal in manifold**

17. Apply grease to a **new** seal ring (4) and insert it in the seal ring groove exposed on the manifold. SEE FIGURE 57.

**Assemble commutator ring**

18. Assemble the commutator ring (6) over alignment studs onto the manifold. SEE FIGURE 58.

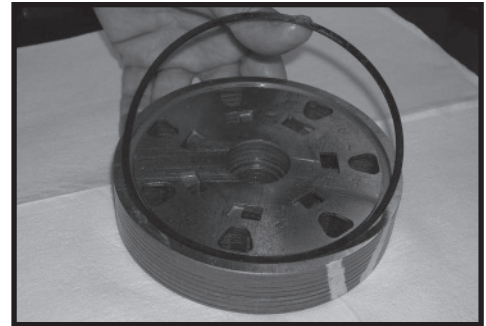

Figure 55

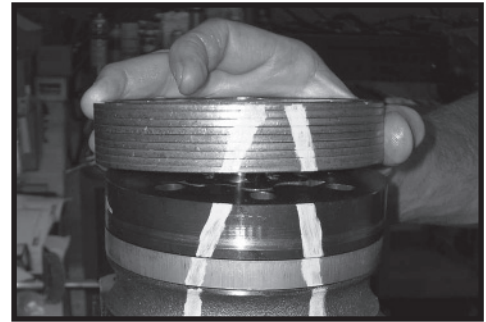

Figure 56

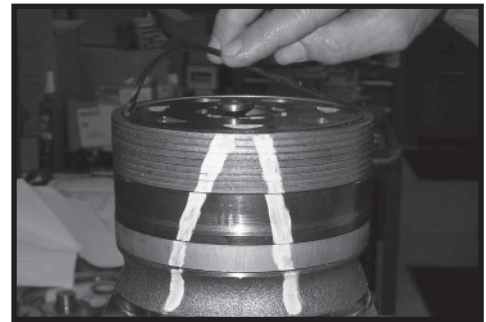

Figure 57



Figure 58

**Assemble seal & commutator**

19. Assemble a **new** seal ring (3) flat side up, into commutator (5) and assemble commutator over the end of drive link (10) onto manifold (7) with seal ring side up. SEE FIGURE 59, 60.

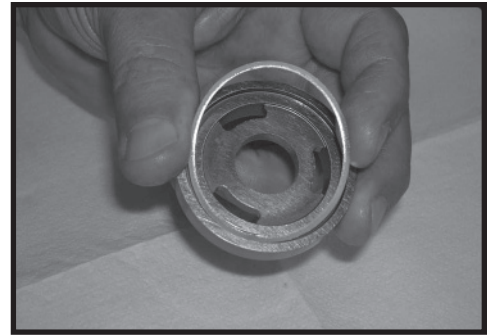

Figure 59

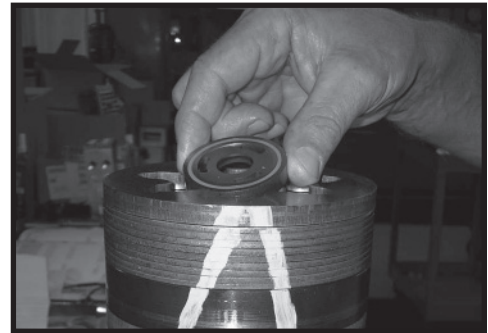

Figure 60

**Assemble shuttle valve parts into end cover**

20. If shuttle valve components items #21, #22, #23, #24 were removed from the end cover (2) turn a plug (21) with a **new** o-ring (22), loosely into one end of the valve cavity in the end cover. Insert a spring (23) the valve (24) and the second spring (23) into the other end of the valve cavity. Turn the second plug (21) with a **new** o-ring (22) loosely into the end cover valve cavity. 3/16 inch Allen wrench required. SEE FIGURE 61.

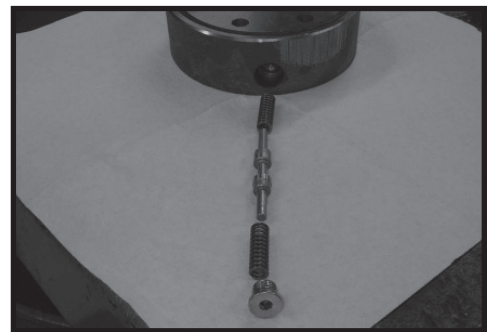

Figure 61

**Assemble relief valve parts in end cover**

21. If relief valve components items #21, #22, #24 were removed from the end cover (2) assemble a **new** o-ring (22) on the two plugs (21). Assemble a two piece relief valve (24) in each of the plugs, with the large end of the conical spring into the plug first and the small nut of the other valve piece in the small end of the conical spring. Turn each of the plug and relief valve assemblies into the end cover loosely to be torqued later. 3/8 inch Allen or 1 inch Hex socket required. SEE FIGURE 62.

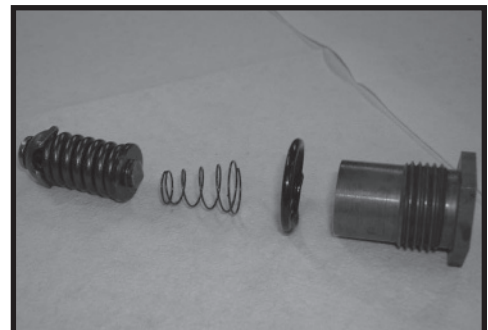

Figure 62

**Assemble seal ring & end cover**

22. Assemble a **new** seal ring (4) into end cover (2) and assemble end cover over the alignment studs and onto the commutator set. SEE FIGURE 63, 64. If the end cover has only 5 bolt holes be sure the cover holes are aligned with the 5 threaded holes in housing (18). The correct 5 bolt end cover bolt hole relationship to housing port bosses is shown in FIGURE 65.

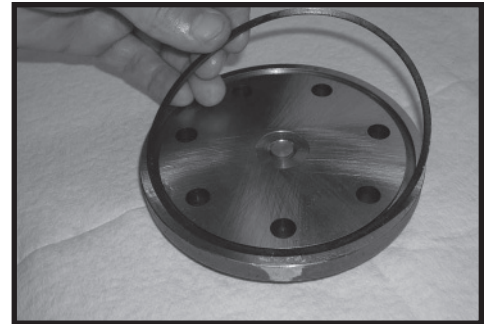

Figure 63

**NOTE**

**NOTE:** If the end cover has a valve (24) or has five bolt holes, use the line you previously scribed on the cover to radially align the end cover into its original position.

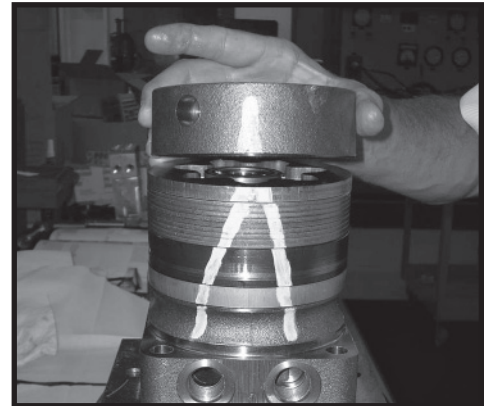

Figure 64

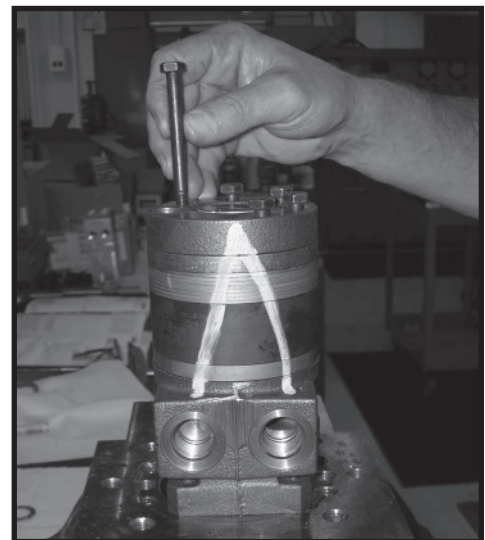

Figure 65

**Assemble cover bolts**

23. Assemble the 5, 6 or 7 special bolts (1, 1A, 1B or 1C) and screw in finger tight. Remove and replace the two alignment studs with bolts after the other bolts are in place. Alternately and progressively tighten the bolts to pull the end cover and other components into place with a final torque of 25-30 ft. lbs. (34-41 N m) for the five TC, TS, TB or six TE Series 5/16 24 threaded bolts or six TJ bolts or 50-55 ft. lbs. (68-75 N m) for the seven TF, TL, TG & TH Series 3/8-24 threaded bolts. SEE FIGURE 66, 67, 68.

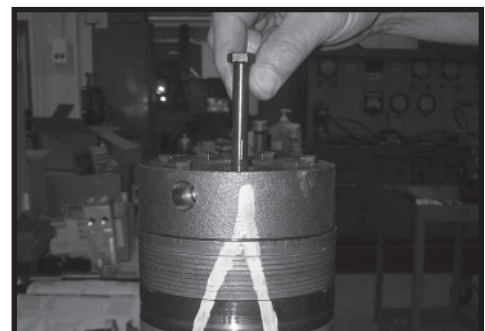

Figure 66

**NOTE**

**NOTE:** The special bolts required for use with the relief or shuttle valve (24) end cover assembly (2) are longer than the bolts required with standard and cover assembly. Refer to the individual service parts lists or parts list charts for correct service part number if replacement is required.

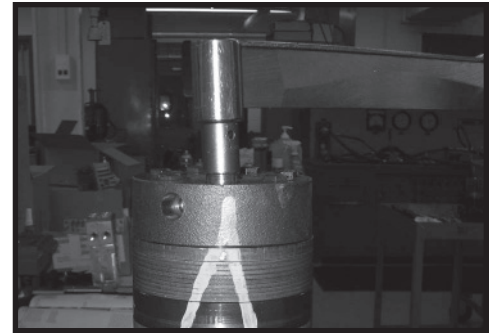

Figure 67

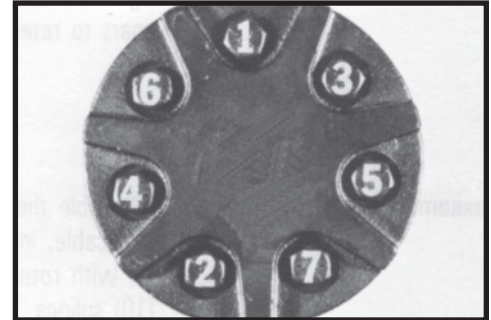

Figure 68

**Torque the valve plugs**

- 24. Torque the two shuttle valve plug assemblies (21) in end cover assembly to 9-12 ft. lbs. (12-16 N m) if cover is so equipped. SEE FIGURE 69.

Torque the two relief valve plug assemblies (21) in end cover assembly to 45-55 ft. lbs. (61-75 N m) if cover is so equipped.

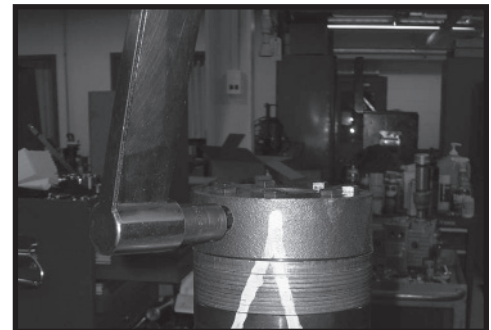

Figure 69

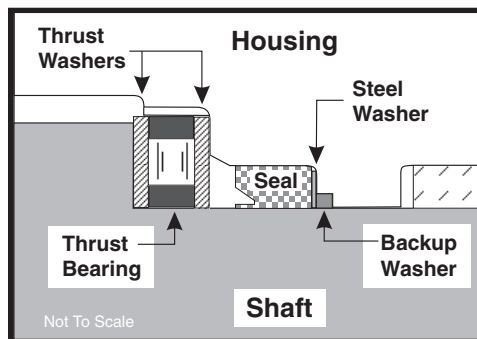

Figure 69A

Large Frame

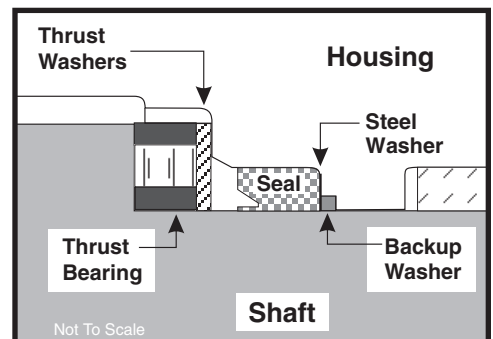

Figure 69B

Small Frame

THE ASSEMBLY OF THE TORQMOTOR™ IS NOW COMPLETE EXCEPT FOR WOODRUFF KEY (12A), NUT (12B), WASHER (12C), BOLT (12D), LOCKWASHER (12E), RETAINER RING (12F) or PORT O-RINGS (18A) AT INSTALLATION IF APPLICABLE. PROCEED TO FINAL CHECKS SECTION.

## One Piece Stator Construction

A disassembled rotor (8A) stator (8B) and vanes (8C) that cannot be readily assembled by hand can be assembled by the following procedures.

**Assemble stator** 1. Place stator (8B) onto wear plate (9) with seal ring (4) side down, after following Torqmotor™ assembly procedures 1 through 13. Be sure the seal ring is in place. SEE FIGURE 70.

**Insert two bolts** 2. If assembly alignment studs are not being utilized, align stator bolt holes with wear plate and housing bolt holes and turn two bolts (1) finger tight into bolt holes approximately 180 degrees apart to retain stator and wear plate stationary.

**Assemble rotor** 3. Assemble the rotor (8A), counterbore down if applicable, into stator (8B), and onto wear plate (9) with rotor splines into mesh with drive link (10) splines. SEE FIGURE 71.

### NOTE

**NOTE:** If the manifold side of the rotor was etched during Torqmotor disassembly, this side should be up. If the rotor is not etched and does not have a counterbore, use the drive link spline contact pattern apparent on the rotor splines to determine the rotor side that must be against the wear plate.

**Assemble vanes** 4. Assemble six vanes (8C), or as many vanes that will readily assemble into the stator vane pockets. SEE FIGURE 72.

### CAUTION

**CAUTION:** Excessive force used to push the rotor vanes into place could shear off the coating applied to the stator vane pockets.

**Assemble full complement of vanes**

5. Grasp the output end of coupling shaft (12) with locking pliers or other appropriate turning device and rotate coupling shaft, drive link and rotor to seat the rotor and the assembled vanes (8C) into stator (8B), creating the necessary clearance to assemble the seventh or full complement of seven vanes. Assemble the seven vanes using minimum force. SEE FIGURE 73.

**Remove two**

**assembled bolts** 6. Remove the two assembled bolts (1) if used to retain stator and wear plate.

Go to Torqmotor™ assembly procedure #15, to continue Torqmotor™ assembly.



Figure 70

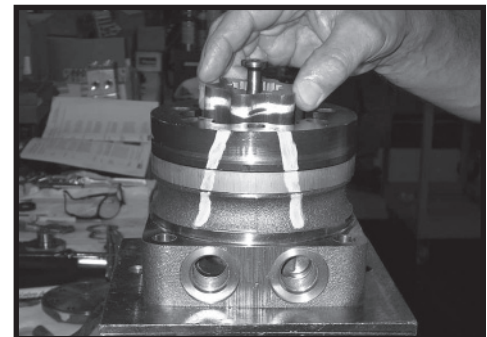

Figure 71

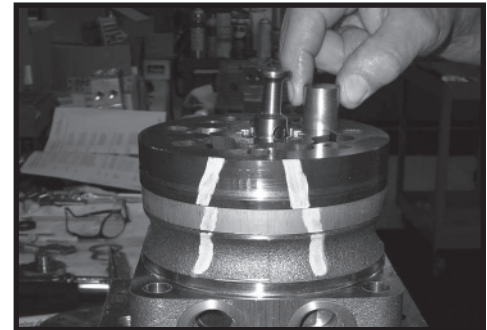

Figure 72

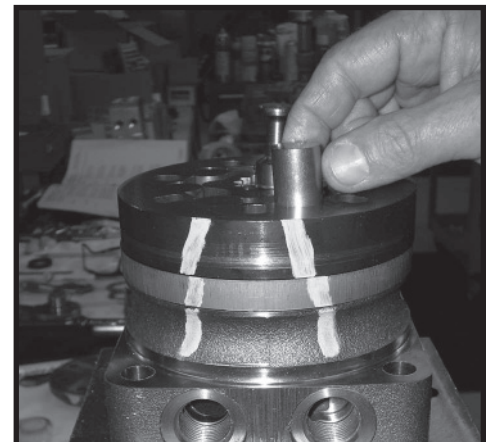

Figure 73



## Two Piece Stator Construction

A disassembled rotor set (8) that cannot be readily assembled by hand and has a two piece stator can be assembled by the following procedures.

**Assemble stator halves** 1. Place stator half (8B) onto wear plate (9) with seal ring (4) side down, after following Torqmotor™ assembly procedures 1 through 13. Be sure the seal ring is in place.

**Insert two alignment studs** 2. Align stator bolt holes with wear plate and housing bolts and turn two alignment studs finger tight into bolt holes approximately 180 degrees apart to retain stator half and wear plate stationary.

**Assemble rotor** 3. Assemble rotor (8A), counterbore down if applicable, into stator half (8B), and onto wear plate (9) with rotor splines into mesh with drive link (10) splines.

**NOTE** **NOTE: Use any marking you applied to rotor set components to reassemble the components in their original relationship to ensure ultimate wear life and performance.**

**Assemble vanes** 4. Assemble six vanes (8C), or as many vanes that will readily assemble into the stator vane pockets.

### CAUTION

**CAUTION: Excessive force used to push the rotor vanes into place could shear off the coating applied to the stator vane pockets.**

**Assemble full complement of vanes** 5. Grasp the output end of coupling shaft (12) with locking pliers or other appropriate turning device and rotate coupling shaft, drive link and rotor to seat the rotor and the assembled vanes (8C) into stator half (8B), creating the necessary clearance to assemble the seventh or full complement of seven vanes. Assemble the seven vanes using minimum force.

**Assemble seal ring in stator half** 6. Place second stator half (8D) on a flat surface with seal ring groove up. Apply a small amount of grease to a **new** seal ring (4) and assemble it into stator half ring groove.

- Assemble second stator half**
7. Assemble the second stator half (8D) over the two alignment studs and rotor (8A) with seal ring side down onto the first stator half (8B) aligning any timing marks applied for this purpose.

**CAUTION**

**CAUTION: If the stator half (8B) is a different height (thickness) than stator half (8D) the stator vanes (8C) or (8E) of the same length (height) as the stator half must be reassembled in their respective stator half for the rotor set to function properly.**

- Assemble vanes**
8. Assemble six vanes (8E), or as many vanes that will readily assemble into the stator vane pockets.

- Assemble full complement of vanes**
9. Grasp the output end of coupling shaft (12) with locking pliers or other appropriate turning device and rotate coupling shaft, drive link and rotor to seat the rotor and the assembled vanes (8E) into stator (8D), creating the necessary clearance to assemble the seventh or full complement of seven vanes. Assemble the seven vanes using minimum force.

Go to Torqmotor™ assembly procedure #15, to continue Torqmotor™ assembly.

## Final Checks

- Pressurize the Torqmotor™ with 100 p.s.i. dry air or nitrogen and submerge in solvent to check for external leaks.
- Check Torqmotor™ for rotation. Torque required to rotate coupling shaft should not be more than 50 ft. lbs. (68 N m)
- On TC, TS, TB, TE & TJ Series Torqmotors, pressure port with “A” cast under it on housing (18) is for clockwise coupling shaft rotation as viewed from the output end of coupling shaft. Pressure port with “B” cast under it is for counter clockwise coupling shaft rotation.
- On TF, TL, TG, & TH Series Torqmotors, pressure port with “B” cast under it on housing (18) is for clockwise coupling shaft rotation as viewed from the output end of coupling shaft. Pressure port with “A” cast under it is for counter clockwise coupling shaft rotation.
- Use test stand if available, to check operation of the Torqmotor™.

## Hydraulic Fluid

Keep the hydraulic system filled with one of the following:

- 10W40 SE or SF manufacturers suggested oil.
- Hydraulic fluid as recommended by equipment manufacturer, but the viscosity should not drop below 50 SSU or contain less than .125% zinc anti-wear additives.

**CAUTION: Do not mix oil types. Any mixture, or an unapproved oil, could deteriorate the seals. Maintain the proper fluid level in the reservoir. When changing fluid, completely drain old oil from the system. It is suggested also that you flush the system with clean oil.**

## Filtration

Recommended filtration 20-50 micron.

## Oil Temperature

Maximum operating temperature 200°F (93.3° C).

## Tips for Maintaining the Torqmotor™ Hydraulic System

- Adjust fluid level in reservoir as necessary.
- Encourage all operators to report any malfunction or accident that may have damaged the hydraulic system or component.
- Do not attempt to weld any broken Torqmotor™ component. Replace the component with original equipment only.
- Do not cold straighten, hot straighten, or bend any Torqmotor™ part.
- Prevent dirt or other foreign matter from entering the hydraulic system. Clean the area around and the filler caps before checking oil level.
- Investigate and correct any external leak in the hydraulic system, no matter how minor the leak.
- Comply with manufacturer's specifications for cleaning or replacing the filter.

**CAUTION: Do not weld, braze, solder or any way alter any Torqmotor™ component.**

**CAUTION: Maximum operating pressure must not exceed recommended Torqmotor™ pressure capacity.**

**CAUTION: Always carefully inspect any system component that may have been struck or damaged during operation or in an accident. Replace any component that is damaged or that is questionable.**

**CAUTION: Do not force any coupling onto the Torqmotor™ coupling shaft as this could damage the unit internally.**

Parker extends close technical cooperation and assistance. If problems occur which you cannot solve, please contact your local Parker approved Distributor or Parker Technical Support. Our phone number and fax number and address are on the back cover of this manual.





## Offer of Sale

The items described in this document and other documents or descriptions provided by Parker Hannifin Corporation, its subsidiaries and its authorized distributors are hereby offered for sale at prices to be established by Parker Hannifin Corporation, its subsidiaries and its authorized distributors. This offer and its acceptance by any customer ("Buyer") shall be governed by all of the following Terms and Conditions. Buyer's order for any such items, when communicated to Parker Hannifin Corporation, its subsidiary or an authorized distributor ("Seller") verbally or in writing, shall constitute acceptance of this offer.

**1. Terms and Conditions of Sale:** All descriptions, quotations, proposals, offers, acknowledgments, acceptances and sales of Seller's products are subject to and shall be governed exclusively by the terms and conditions stated herein. Buyer's acceptance of any offer to sell is limited to these terms and conditions. Any terms or conditions in addition to, or inconsistent with those stated herein, proposed by Buyer in any acceptance of an offer by Seller, are hereby objected to. No such additional, different or inconsistent terms and conditions shall become part of the contract between Buyer and Seller unless expressly accepted in writing by Seller. Seller's acceptance of any offer to purchase by Buyer is expressly conditional upon Buyer's assent to all the terms and conditions stated herein, including any terms in addition to, or inconsistent with those contained in Buyer's offer. Acceptance of Seller's products shall in all events constitute such assent.

**2. Payment:** Payment shall be made by Buyer net 30 days from the date of delivery of the items purchased hereunder. Amounts not timely paid shall bear interest at the maximum rate permitted by law for each month or portion thereof that the Buyer is late in making payment. Any claims by Buyer for omissions or shortages in a shipment shall be waived unless Seller receives notice thereof within 30 days after Buyer's receipt of the shipment.

**3. Delivery:** Unless otherwise provided on the face hereof, delivery shall be made F.O.B. Seller's plant. Regardless of the method of delivery, however, risk of loss shall pass to Buyer upon Seller's delivery to a carrier. Any delivery dates shown are approximate only and Seller shall have no liability for any delays in delivery.

**4. Warranty:** Seller warrants that the items sold hereunder shall be free from defects in material or workmanship for a period of 18 months from date of shipment from Parker Hannifin Corporation. **THIS WARRANTY COMPRISES THE SOLE AND ENTIRE WARRANTY PERTAINING TO ITEMS PROVIDED HEREUNDER. SELLER MAKES NO OTHER WARRANTY, GUARANTEE, OR REPRESENTATION OF ANY KIND WHATSOEVER. ALL OTHER WARRANTIES, INCLUDING BUT NOT LIMITED TO, MERCHANTABILITY AND FITNESS FOR PURPOSE, WHETHER EXPRESS, IMPLIED, OR ARISING BY OPERATION OF LAW, TRADE USAGE, OR COURSE OF DEALING ARE HEREBY DISCLAIMED.**

**NOTWITHSTANDING THE FOREGOING, THERE ARE NO WARRANTIES WHATSOEVER ON ITEMS BUILT OR ACQUIRED WHOLLY OR PARTIALLY, TO BUYER'S DESIGNS OR SPECIFICATIONS.**

**5. Limitation Of Remedy: SELLER'S LIABILITY ARISING FROM OR IN ANY WAY CONNECTED WITH THE ITEMS SOLD OR THIS CONTRACT SHALL BE LIMITED EXCLUSIVELY TO REPAIR OR REPLACEMENT OF THE ITEMS SOLD OR REFUND OF THE PURCHASE PRICE PAID BY BUYER, AT SELLER'S SOLE OPTION. IN NO EVENT SHALL SELLER BE LIABLE FOR ANY INCIDENTAL, CONSEQUENTIAL OR SPECIAL DAMAGES OF ANY KIND OR NATURE WHATSOEVER, INCLUDING BUT NOT LIMITED TO LOST PROFITS ARISING FROM OR IN ANY WAY CONNECTED WITH THIS AGREEMENT OR ITEMS SOLD HEREUNDER, WHETHER ALLEGED TO ARISE FROM BREACH OF CONTRACT, EXPRESS OR IMPLIED WARRANTY, OR IN TORT, INCLUDING WITHOUT LIMITATION, NEGLIGENCE, FAILURE TO WARN OR STRICT LIABILITY.**

**6. Changes, Reschedules and Cancellations:** Buyer may request to modify the designs or specifications for the items sold hereunder as well as the quantities and delivery dates thereof, or may request to cancel all or part of this order, however, no such requested modification or cancellation shall become part of the contract between Buyer and Seller unless accepted by Seller in a written amendment to this Agreement. Acceptance of any such requested modification or cancellation shall be at Seller's discretion, and shall be upon such terms and conditions as Seller may require.

**7. Special Tooling:** A tooling charge may be imposed for any special tooling, including without limitation, dies, fixtures, molds and patterns, acquired to manufacture items sold pursuant to this contract. Such special tooling shall be and remain Seller's property notwithstanding payment of any charges by Buyer. In no event will Buyer acquire any interest in apparatus belonging to Seller which is utilized in the manufacture of the items sold hereunder, even if such apparatus has been specially converted or adapted for such manufacture and notwithstanding any charges paid

by Buyer. Unless otherwise agreed, Seller shall have the right to alter, discard or otherwise dispose of any special tooling or other property in its sole discretion at any time.

**8. Buyer's Property:** Any designs, tools, patterns, materials, drawings, confidential information or equipment furnished by Buyer or any other items which become Buyer's property, may be considered obsolete and may be destroyed by Seller after two (2) consecutive years have elapsed without Buyer placing an order for the items which are manufactured using such property, Seller shall not be responsible for any loss or damage to such property while it is in Seller's possession or control.

**9. Taxes:** Unless otherwise indicated on the face hereof, all prices and charges are exclusive of excise, sales, use, property, occupational or like taxes which may be imposed by any taxing authority upon the manufacture, sale or delivery of the items sold hereunder. If any such taxes must be paid by Seller or if Seller is liable for the collection of such tax, the amount thereof shall be in addition to the amounts for the items sold. Buyer agrees to pay all such taxes or to reimburse Seller therefore upon receipt of its invoice. If Buyer claims exemption from any sales, use or other tax imposed by any taxing authority, Buyer shall save Seller harmless from and against any such tax, together with any interest or penalties thereon which may be assessed if the items are held to be taxable.

**10. Indemnity For Infringement of Intellectual Property Rights:** Seller shall have no liability for infringement of any patents, trademarks, copyrights, trade dress, trade secrets or similar rights except as provided in this Part 10. Seller will defend and indemnify Buyer against allegations of infringement of U.S. Patents, U.S. Trademarks, copyrights, trade dress and trade secrets (hereinafter 'Intellectual Property Rights'). Seller will defend at its expense and will pay the cost of any settlement or damages awarded in an action brought against Buyer based on an allegation that an item sold pursuant to this contract infringes the Intellectual Property Rights of a third party. Seller's obligation to defend and indemnify Buyer is contingent on Buyer notifying Seller within ten (10) days after Buyer becomes aware of such allegations of infringement, and Seller having sole control over the defense of any allegations or actions including all negotiations for settlement or compromise. If an item sold hereunder is subject to a claim that it infringes the Intellectual Property Rights of a third party, Seller may, at its sole expense and option, procure for Buyer the right to continue using said item, replace or modify said item so as to make it noninfringing, or offer to accept return of said item and return the purchase price less a reasonable allowance for depreciation. Notwithstanding the foregoing, Seller shall have no liability for claims of infringement based on information provided by Buyer, or directed to items delivered hereunder for which the designs are specified in whole or part by Buyer, or infringements resulting from the modification, combination or use in a system of any item sold hereunder. The foregoing provisions of this Part 10 shall constitute Seller's sole and exclusive liability and Buyer's sole and exclusive remedy for infringement of Intellectual Property Rights.

If a claim is based on information provided by Buyer or if the design for an item delivered hereunder is specified in whole or in part by Buyer, Buyer shall defend and indemnify Seller for all costs, expenses or judgments resulting from any claim that such item infringes any patent, trademark, copyright, trade dress, trade secret or any similar right.

**11. Force Majeure:** Seller does not assume the risk of and shall not be liable for delay or failure to perform any of Seller's obligations by reason of circumstances beyond the reasonable control of Seller (hereinafter 'Events of Force Majeure'). Events of Force Majeure shall include without limitation, accidents, acts of God, strikes or labor disputes, acts, laws, rules or regulations of any government or government agency, fires, floods, delays or failures in delivery of carriers or suppliers, shortages of materials and any other cause beyond Seller's control.

**12. Entire Agreement/Governing Law:** The terms and conditions set forth herein, together with any amendments, modifications and any different terms or conditions expressly accepted by Seller in writing, shall constitute the entire Agreement concerning the items sold, and there are no oral or other representations or agreements which pertain thereto. This Agreement shall be governed in all respects by the law of the State of Ohio. No actions arising out of the sale of the items sold hereunder or this Agreement may be brought by either party more than two (2) years after the cause of action accrues.

9/91-P



**Parker Hannifin Corporation**  
2745 Snapps Ferry Road  
Greeneville, TN 37745 USA  
Tel: (423) 639-8151  
FAX: (423) 787-2418  
[www.parker.com/pumpmotor](http://www.parker.com/pumpmotor)