

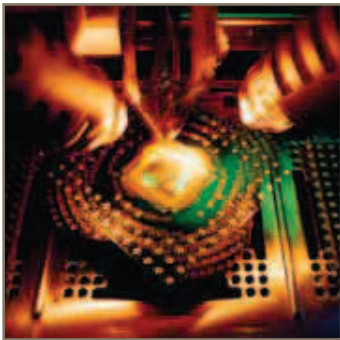

aerospace
climate control
electromechanical
filtration
fluid & gas handling
hydraulics
pneumatics
process control
sealing & shielding

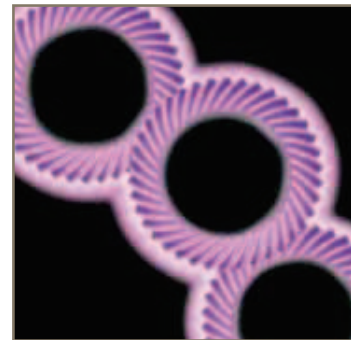

Gearheads and Gearmotors



ENGINEERING YOUR SUCCESS.

Parker Hannifin Corporation

A Fortune 300 company with annual sales exceeding \$10 billion and more than 400,000 customers in 43 countries, Parker Hannifin is the world's leading supplier of innovative motion control components and system solutions serving the industrial, mobile, and aerospace markets. We are the only manufacturer offering customers a choice of electromechanical, hydraulic, pneumatic, or computer-controlled motion systems.

Total System Solutions

Parker's team of highly qualified application engineers, product development engineers, and system specialists can turn pneumatic, structural, and electromechanical products into an integrated system solution.

Moreover, our Selectable Levels of Integration™ allows you to choose the appropriate system, subsystem, or component to meet your specific need.



Parker offers complete engineered systems.

First in Delivery, Distribution, and Support

In today's competitive, fast-moving economy, what good is an application that isn't ready on time? This is especially true when compressed design cycles make the quick delivery of critical components essential. With factories strategically located on five continents, Parker offers an unrivaled delivery record, getting solutions out our door and onto your floor faster than ever.

Parker also has the industry's largest global distribution network, with more than 8,600 distributors worldwide. Each of these locations maintains ample product inventory to keep your downtime to a minimum. And many distributors have in-house design capabilities to support your system and subsystem requirements.

Throughout the design process, Parker's factory-trained electromechanical engineers work hand in hand with you and day or night at 1-800-C-Parker. Our operators will connect you with a live, on-call representative who will identify replacement parts or services for all motion technologies.



Parker world headquarters in Cleveland

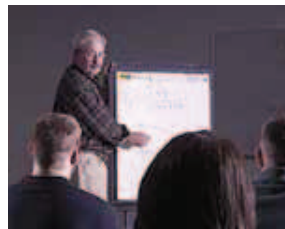

Training

Parker's best-in-class technology training includes hands-on classes, Web-based instruction, and comprehensive texts for employees, distributors,

and customers. Parker also provides computer-based training, PowerPoint presentations, exams, drafting and simulation software, and trainer stands.

parkermotion.com

Our award-winning Web site is your single source for:

- **Product information**
- **Downloadable catalogs**
- **Motion-sizing software**
- **3D design files**
- **Training materials**
- **Product-configuration software**
- **RFQ capabilities**
- **Videos and application stories**



24/7 Emergency Breakdown Support

The Parker product information center is available any time of the day or night at 1-800-C-Parker. Our operators will connect you with a live, on-call representative who will identify replacement parts or services for all motion technologies.

Table of Contents

Product Overview

4 – 7 Products and Technologies; Application Examples

Planetary Gearheads

8 – 49 Overview and Selection

Generation II Stealth® PS/PX/RS/RX Series:

- 60 – 115 mm / NEMA 23-42
- In-line and Right Angle

Generation I Stealth® PS/PX/RS/RX Series:

- 142 – 220 mm / NEMA 56
- In-line and Right Angle

PV Series:

- 40 – 115 mm / NEMA 17-42
- In-line

Multi-Drive Right-Angle Gearheads

50 – 57 Overview and Selection

- RT Hollow Shaft Series: 90 – 220 mm
- RD Double Shaft Series: 90 – 220 mm
- RB Low Ratio Series: 90 – 220 mm

Bevel/Spur Gearheads

58 – 61 Overview and Selection

- NE Series: NEMA 23 – 42 (In-line)

Gearmotors (integrated planetary gearhead and servo motor)

62 – 68 Overview and Selection

DX Series ServoWheel™:

- Gearmotor Drive Wheels for Electric Vehicles

Related Products and Services

69 – 71 Other Parker Products

72 – 73 Gearhead Sizing/Selection Design Reference

74 Offer of Sale

If you don't find exactly what you are looking for in this catalog, please contact us for information on other suitable Parker products or to have an application engineer discuss your requirements.

Visit our Website

Complete up-to-date technical assistance can be found on our web at www.parkermotion.com. This includes all the latest information on current products, new product introductions, local assistance and support, plus a comprehensive “Engineering Reference Library” including: complete product catalog data, product selection Wizards, performance charts and graphs, engineering data and calculations, CAD drawings, local service and support directory, on-line purchasing, application stories and videos.



Welcome!

Thank you for your interest in the products offered by the Parker Hannifin Electromechanical Automation Division. This catalog presents Parker's electromechanical solutions for high-precision and high-speed automation. Our gearheads, motors, and integrated products are recognized around the world for their functionality, performance, and reliability.

Bayside pioneered the market for precision servo gearheads many years ago. Parker continues this tradition in quality and design with innovations like our Stealth Generation II Helical Planetary Gearhead, enhanced to provide superior performance for the most demanding applications. Our PV Series planetary gearhead combines power and versatility in an economical package. Our line of Frameless Motors, Servo Wheels, and other integrated products provide an ideal solution for machine designs that require high performance in small spaces.

As you read through this catalog, you will discover that Parker offers the widest variety of electromechanical solutions that are delivered in the shortest amount of time. Still, many customers require special solutions to satisfy unique or special requirements. Parker has been providing custom engineered solutions for over 30 years to satisfy those requirements. If your application cannot be fulfilled by the complement of products found in this catalog, please contact an authorized Parker Automation Technology Center or a factory applications engineer.

Parker is proud to present these high precision products to you. We invite you to discover the advantages that can be realized by relying on Parker for products and systems which represent the very best value in the electromechanical marketplace.

Sincerely,



Ken Sweet
General Manager

Product Overview

Planetary Gearheads

Our new Generation II Stealth® Series provides higher radial load, increased service life and ease of mounting than comparably sized planetary gearheads. The Stealth Generation II Helical Planetary Gearheads incorporate design enhancements to provide superior performance for the most demanding high performance applications. For larger frame sizes, Parker offers Generation I Stealth® Series gearheads in 142 to

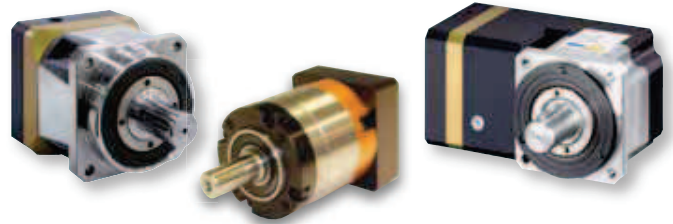

220 mm and NEMA 56 frame sizes. For standard precision applications, the PV Series gearhead combines power and versatility in an economical package available in a wide range of options.

Product Series	Gear Geometry	Performance	Configuration	Frame Size	Nominal Continuous Torque	Radial Load	Backlash arc-min	Page	
					Nm (in-lb)	N (lbs)			
Generation II Stealth®	PS	Helical Planetary	High Precision	In-Line	60 – 115 mm	27 – 230 (240 – 2047)	1650 – 7500 (370 – 1683)	8 – <3	12
	PX	Helical Planetary	Mid Precision	In-Line	60 – 115 mm NEMA 23 – 42	20 – 160 (178 – 1424)	1550 – 6800 (348 – 1526)	10 – <6	16
	RS	Helical Planetary/ Spiral Bevel	High Precision	Right Angle	60 – 115 mm	13 – 220 (115 – 1958)	1650 – 7500 (370 – 1683)	14 – <6	20
	RX	Helical Planetary/ Right Angle	Mid Precision	Right Angle	60 – 115 mm NEMA 23 – 42	10 – 136 (89 – 1210)	1550 – 6800 (348 – 1526)	20 – <12	24
Generation I Stealth®	PS	Helical Planetary	High Precision	In-Line	180 – 220 mm	294 – 1808 (2616 – 16,091)	7900 – 58,000 (1775 – 13,020)	8 – <3	30
	PX	Helical Planetary	Mid Precision	In-Line	142 mm NEMA 56	220 – 278 (1958 – 2474)	6000 (1347)	10 – <8	34
	RS	Helical Planetary/ Spiral Bevel	High Precision	Right Angle	180 – 220 mm	141 – 1808 (1255 – 16,091)	7900 – 58,000 (1775 – 13,020)	10 – <4	36
PV	Planetary	Standard	In-Line	40 – 115 mm NEMA 17 – 42	3.5 – 148 (31 – 1317)	190 – 10,555 (43 – 2370)	15 – <12	40	

MultiDrive Gearheads

Stealth® MultiDrive (MD) offers three different output options for true flexibility. MultiDrive models include low-ratio, dual-shaft and hollow-shaft options in a compact, right angle package. With 5 frame sizes and multiple ratios to choose from, you are guaranteed to find a Stealth® MultiDrive to fit your servo motor application.

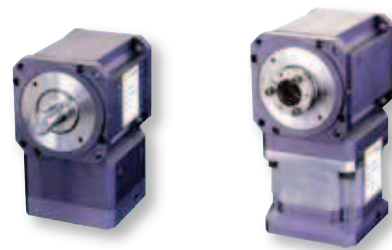

Product Series	Gear Geometry	Performance	Configuration	Frame Size	Continuous Torque	Radial Load	Backlash arc-min	Page
					Nm (in-lb)	N (lbs)		
RT	Helical	High Precision	Right Angle Hollow Shaft	90 – 220 mm	23 – 565 (204 – 5178)	2800 – 7500 (692 – 1685)	<14 – <6	50
RD	Helical	High Precision	Right Angle Double Shaft	90 – 220 mm	30 – 150 (266 – 1328)	2800 – 7500 (692 – 1685)	<14 – <6	50
RB	Helical	High Precision	Right Angle Low Ratio	90 – 220 mm	35 – 190 (266 – 1682)	2800 – 7500 (692 – 1685)	<14 – <6	50

NEMA Gearheads

NEMA gearheads feature a high-efficiency spur gear design, in a light, compact package, and are ideal for applications requiring smooth operation and low starting torque. Ratios from 3:1 to 100:1 are available.



Product Series	Gear Geometry	Performance	Configuration	Frame Size	Continuous Torque	Radial Load	Backlash arc-min	Page
					Nm (in-lb)	N		
NE	Spur Gear	Economy	In-Line	NEMA 23 – 42	6 – 40 (50 – 350)	90 – 890 (20 – 200)	10 – 30	58

Integral Solution Gearmotors

Stealth® Gearmotors represent the first time a brushless servo motor and a helical planetary gearhead have been integrated into a single product. Previously, engineers needing a gear drive with servo motor were forced to purchase the gearhead and motor separately. Parker Bayside manufactures precision gearheads and gearmotors under one roof.



Product Series	Gear Geometry	Performance	Configuration	Frame Size	Continuous Torque	Feedback	Backlash	Page
					Nm (in-lb)		arc-min	
GM	Helical Planetary	Mid-Precision	In-Line	60 – 142 mm NEMA 23 – 56	3 – 60	Encoder/ Resolver	< 10	Consult Factory
DX	Planetary	Mid-Precision	In-Line	6 and 8 inch dia. Wheel Drive	26 – 48	Encoder	—	62

Application Examples

Plastic Bottle Extrusion

The manufacturer of high-performance plastic extrusion equipment needed a drop-in replacement gearhead for an existing worm gearbox used with their motor without having to alter the design of their machine. The gearhead/motor combination is being used to drive the machine's rollers, controlling the speed at which the plastic is extruded into high-quality plastic sheets. The smoothness of the rollers is critical to the quality of the plastic sheets being produced.



Application Challenges:

High Transmission Error and Velocity Ripple

The customer used worm gearheads to control the rollers. Worm gears exhibit a sliding action of involute gears instead of a rolling action, contributing to the lack of smoothness of the machine rollers. Due to the high transmission error and velocity ripple from the worm drive, the rollers operated at differing speeds. This produced small lines and imperfections on the plastic sheets, rendering it unusable.

High Wear and Low Efficiency

The high level of rubbing (sliding action) between the worm and wheel teeth in the worm gearhead caused a high gear-tooth-wear rate and a lower efficiency (70%) than other major gear types.

Parker SOLUTION:

Stealth PS Gearhead and RT MultiDrive (hollow shaft) Gearhead were used in combination to provide the required 120:1 ratio. The result was high-quality plastics sheets that exceeded the customer's specifications.



The Stealth's all-helical planetary design (HeliCrown Gear Tooth) features extremely high gear tooth accuracy, minimizing transmission error and velocity ripple. The HeliCrown design features extremely high efficiency (95%) while minimizing tooth wear by providing a pure rolling action. Parker's Plasma Nitriding heat-treating process further heightens the gear tooth's wear resistance.

The MultiDrive gearhead features a space-saving bore (hollow shaft) option, eliminating compliance that occurs when coupling a gearhead shaft to the rollers being driven. This solution can be used for a variety of applications, including packaging, food, semiconductor, automotive and medical.

Food/Packaging Automation

A manufacturer of machines for gluing, fill, sealing and diverting food containers for the food-processing industry had a



requirement for the motor and gearhead to be mounted above the food plane. Certain modifications were also needed for the gearhead to make it safe for the food environment, and capable to withstand frequent washdowns.

- **Output Shaft – stainless steel prevents any rust from developing and contaminating the processing food.**

Parker SOLUTION:

Stealth PS planetary gearhead with standard F01 food grade special option



Stealth PS planetary gearhead with standard food grade option provides the gearhead with standard modifications including special lubrication, viton seals, special finish and a stainless steel output shaft.

Since this food grade modification is a standard option, delivery is only one week over the standard gearhead lead time. (Note: Similar standard modifications exist for vacuum, clean room, high temperature and radiation.)

Gearhead Design Considerations:

- **Lubrication – must be USDA food grade approved in case of incidental contact to food**
- **Sealing – must prevent any leaking as well as prevent any ingress of the fluid during washdown**
- **Finish – special FDA-approved finish must be used making it very durable and resistant to chipping, oxidizing or rusting**

High-Speed Milling

High-speed milling machines are commonplace in industries such as aerospace and automotive because they allow large structural components to be machined from one piece rather than assembled from



many smaller subcomponents. For a customer that manufactures high-speed milling machines, spindle heads are operating at speeds ranging from 18,000 to 40,000 RPM, so that the cutting is above the resonant frequency of the machine. Because of this, many characteristics become more critical than with their standard machines. The extremely large size of the spindle head also posed problems for the manufacturer in trying to keep it accurately positioned during the milling stage.

Application Challenge:

Low Stiffness

The spindle head was moved rotationally by 2 bull gears, driving a large ring gear. Because of the system characteristics, it was difficult to keep the spindle head absolutely stiff during the milling process. The problems associated with low stiffness are:

- **Poor surface finish**
- **Accuracy errors**
- **Excessive tool chatter**
- **Reduced tool life**

Parker SOLUTION:

Two Stealth® PS Helical Planetary Gearheads were used in tandem to create a stiff platform for the spindle machine head. One gearhead, acting as the master, and the other as the slave, were attached to the bull gears to simultaneously turn the ring gear that positioned the machine head. While the master gearhead moved the ring, the slave was taking up the backlash. In this way, the precision gears allowed for the spindle to be moved accurately, while the two gearhead combination maintained maximum system stiffness.

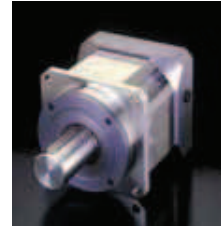

Parker's Stealth PS gearhead features an all-helical planetary gear design. Helical gears have a much higher tooth-contact ratio and greater face width than straight-spur gears, providing higher loads, smoother tooth engagement and quieter operation. The Stealth's HeliCrown Gear Tooth design provides extremely high gear tooth accuracy, while minimizing tooth wear. Parker Bayside's Plasma Nitriding heat-treating process further heightens the gear tooth's wear resistance.

This solution can also be used in the aerospace and automotive industries.

High-, Mid- and Standard-Precision Planetary Gearheads

Helical planetary technology is superb for low-backlash, high-stiffness and high-accuracy requirements, making the Parker Generation II Stealth® line of helical planetary gearheads ideal for these high- and medium-level performance applications. The introduction of the PV Series gearhead completes the Parker gear family by offering a standard-grade gearhead with the highest radial load capacity available today in a cost-effective solution. Whether you need high-, medium- or standard-grade performance, Parker can match the need. All Parker gearheads are proudly manufactured in the USA in our state-of-the-art facility which, displays the best use of Lean manufacturing practices. For more information go to parkermotion.com.



Generation II Stealth® PS/PX/RS/RX:

Our new Generation II Stealth® series provides higher radial load, increased service life and ease of mounting

The Generation II Stealth® Helical Planetary Gearheads incorporate design enhancements to provide superior performance for the most demanding high performance applications.

Stealth Generation II incorporates dual angular contact bearings providing higher radial load capacities while maintaining high input speeds. Design enhancements also include full complement needle bearings allowing for increased service life and extended warranties. Internal design changes and optimized gearing geometries allow for one oil fill level for any orientation, resulting in shortened part number designation and simplified order placement.

Universal mounting kits provide common mounting kits across multiple product lines to promote quicker deliveries and ease of mounting to any servo motor. Applications that require either high precision (PS/RS Series Gearheads) or mid-range precision (PX/

RX Series Gearheads) utilize the same mounting kit part numbers within the same frame size.

Mounting to any servo motor is as easy as A-B-C (adapter, bushing, collet).

Features & Benefits

- **Higher radial load capacity: widely spaced angular contact output bearings**
- **Increased service life: full complement of planet needle bearings**
- **Universal mounting kits: quicker deliveries and easier mounting**
- **High torque and low backlash: helical planetary gearing**
- **High stiffness: Integral ring gear and rigid sun gear**
- **Higher gear wear resistance: plasma nitriding heat treating**
- **PX models are optionally available with flange mounting for easy installation. (Contact factory for flange mount availability for RX models.)**



Other Planetary Gearheads:

Generation I Stealth® PS, PX and RS Gearheads

For larger frame sizes, Parker offers Generation I Stealth® Series gearheads in 142 to 220 mm and NEMA 56 frame sizes.

PV Series Precision Gearheads

The PV Series gearhead combines power and versatility in an economical package. It comes in a wide range of options including dimensional output face crossovers to the Parker Bayside PX, Alpha LP, Neugart PLE, Stoiber PE and Standard NEMA gearheads.

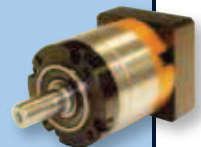

Standard Options for Planetary Gearheads

Gearheads Ready to Mount to Linear Actuators

Most belt driven linear slides need a gearhead to reduce inertia. Parker has pre-engineered in-line and right-angle gearheads to mount directly to most popular linear slides, eliminating the need for couplings or adapters.



Special Environments

Put a Parker gearhead anywhere! Parker can supply gearheads to operate in the harshest environments:



Vacuum - Available as a standard option to 10⁻⁶ Torr vacuum ratings.

Clean Room - Special gearheads for Class 10,000 clean room applications.

High Temperature - Special lubricants and seals for temperatures up to 250° C.

Radiation - Gearheads customized to operate within radioactive environments.

Food Grade/Washdown - Gearheads customized to operate within food-handling and washdown environments.

Input Shaft Speed Reducer/Speed Increaser for Increased Design Flexibility

Parker gearheads are available with an input-shaft option. The input-shaft option allows more design flexibility, as options like brakes, encoders, or safety couplings can be used between the motor and the gearhead. This option also allows you to operate the gearhead as a speed increaser.



Mil-Spec Gearheads

Parker has extensive experience in military and aerospace applications. The Stealth Bomber, M1 Tank and the Space Shuttle all use Parker gearheads. Parker's quality system has been approved by NASA and the US Government to MIL-I-45208A.



Planetary Gearhead Selection Overview

Product Series	Gear Geometry	Performance	Configuration	Frame Size	Nominal Continuous Torque	Radial Load	Backlash arc-min	Page	
					Nm (in-lb)	N (lbs)			
Generation II Stealth®	PS	Helical Planetary	High Precision	In-Line	60 – 115 mm	27 – 230 (240 – 2047)	1650 – 7500 (370 – 1683)	8 – <3	12
	PX	Helical Planetary	Mid Precision	In-Line	60 – 115 mm NEMA 23 – 42	20 – 160 (178 – 1424)	1550 – 6800 (348 – 1526)	10 – <6	16
	RS	Helical Planetary/ Spiral Bevel	High Precision	Right Angle	60 – 115 mm	13 – 220 (115 – 1958)	1650 – 7500 (370 – 1683)	14 – <6	20
	RX	Helical Planetary/ Right Angle	Mid Precision	Right Angle	60 – 115 mm NEMA 23 – 42	10 – 136 (89 – 1210)	1550 – 6800 (348 – 1526)	20 – <12	24
Generation I Stealth®	PS	Helical Planetary	High Precision	In-Line	180 – 220 mm	294 – 1808 (2616 – 16,091)	7900 – 58,000 (1775 – 13,020)	8 – <3	30
	PX	Helical Planetary	Mid Precision	In-Line	142 mm NEMA 56	220 – 278 (1958 – 2474)	6000 (1347)	10 – <8	34
	RS	Helical Planetary/ Spiral Bevel	High Precision	Right Angle	180 – 220 mm	141 – 1808 (1255 – 16,091)	7900 – 58,000 (1775 – 13,020)	10 – <4	36
	PV	Planetary	Standard	In-Line	40 – 115 mm NEMA 17 – 42	3.5 – 148 (31 – 1317)	190 – 10,555 (43 – 2370)	15 – <12	40

Helical Planetary Gearhead Features

Parker planetary gearheads incorporate the latest technology enhancements...

- **Latest technology in seals to reduce heat and wear**
- **Oil lubrication reduces friction and operating temperature, increasing gear life**



Helical Planetary Design

Helical gears have more tooth contact and greater face width than spur gears. This results in higher loads, smoother tooth engagement, quieter operation and lower backlash.



“The Helical Advantage”

Parker planetary gearheads are a superior design with construction integrity to deliver power, speed and accuracy – quietly and efficiently.

HeliCrown®

Parker developed the HeliCrown gear tooth to further optimize Stealth's® performance. Since most vibration occurs at the entry and exit points of a gear tooth, HeliCrown eliminates metal only in these areas, without sacrificing gear strength, producing a quieter and stronger gear.

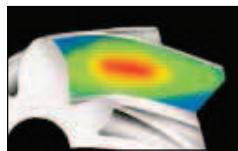

- Power...** 30% more torque than comparably sized gearheads
- Speed...** up to 6,000 RPM input speeds
- Accuracy...** Less than 3 arc-minutes backlash
- Quiet...** Less than 68 dB noise
- Efficiency...** Over 97% efficiency

Plasma Nitriding

Parker's in-house Plasma Nitriding process results in an ideal gear tooth. The surface is very hard (65 Rc) and the core is strong, but flexible (36 Rc). The result is a wear-resistant gear tooth that can withstand heavy shock, ensuring high accuracy for the life of the gearhead.



ServoMount®

Parker's ServoMount design features a balanced input gear supported by a floating bearing. This unique design compensates for motor shaft runout and misalignment, ensuring TRUE alignment of the input sun gear with the planetary section and allowing input speeds up to 6,000 RPM. ServoMount ensures error-free installation to any motor, in a matter of minutes.



Parker Stealth® planetary gearhead features

Features unique to Generation II Stealth® gearheads

- **Widely spaced angular contact bearings provide higher radial load capacity**
- **Full compliment of needle bearings for increased service life**
- **Universal mounting kits offer easier mounting and quick delivery**

Common features for all Generation I & II Stealth® gearheads

- ① **Helical Planetary** - Provides smooth, quiet operation, high torque and high accuracy.
- ② **ServoMount®** - Motor-mounting design ensures error-free installation and the balanced pinion allows higher input speeds.
- ③ **Precision Bearings** - Provide high speed and high radial and axial load capacity.
- ④ **HeliCrown®** - Parker's proprietary gear tooth geometry ensures quieter operation and higher loads than conventional gears.
- ⑤ **Sealed Unit** - Viton seals and O-Rings provide IP65 protection to prevent leaks and protect against harsh environments.
- ⑥ **Integral Ring Gear** - Cutting the ring gear directly into the housing allows for larger bearing and planet gears, delivering maximum power and stiffness in a minimum package.

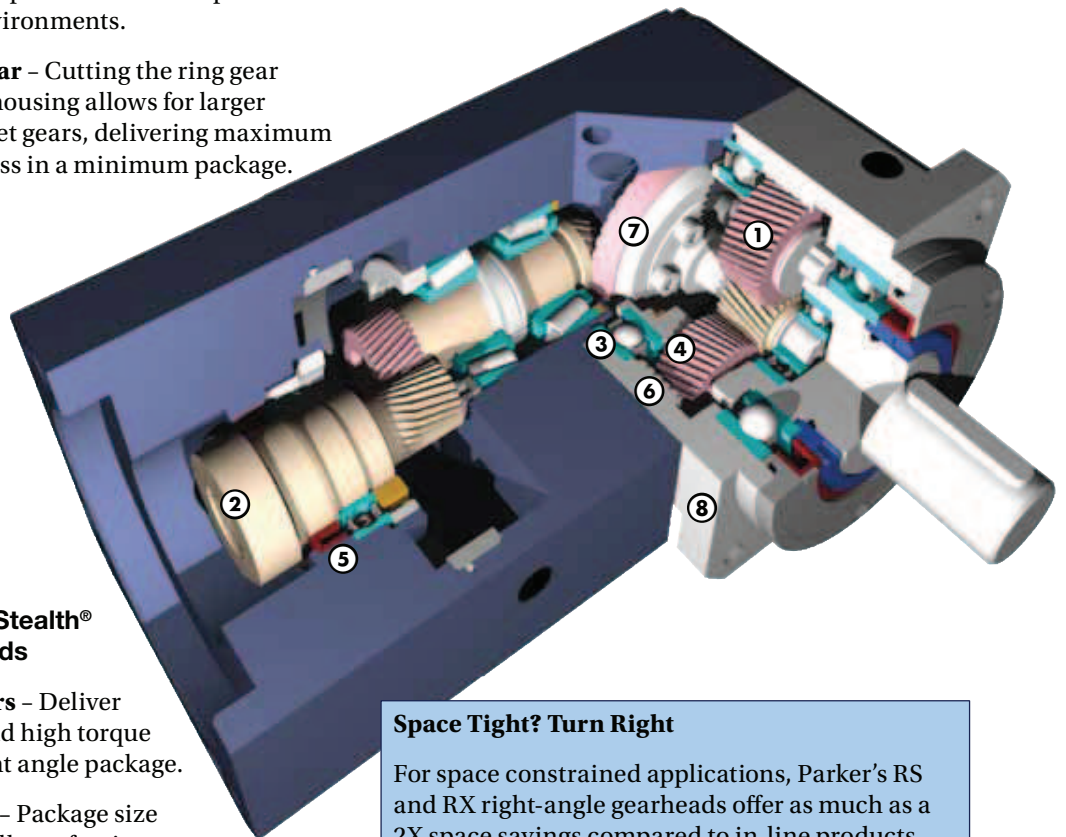
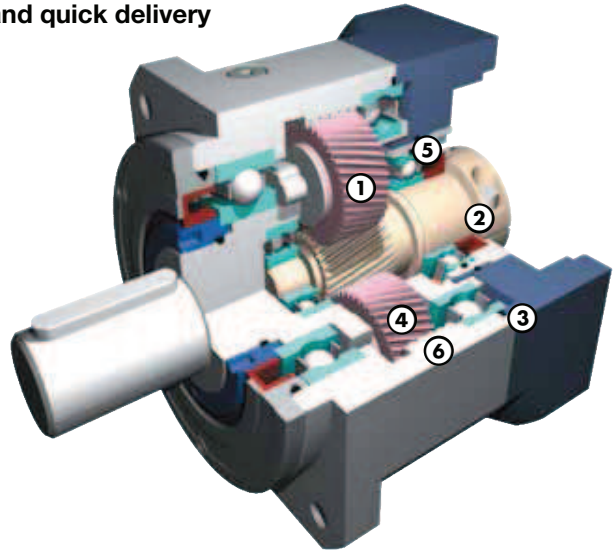

Features unique to Stealth® right-angle gearheads

- ⑦ **Spiral Bevel Gears** - Deliver high efficiency and high torque in a compact, right angle package.
- ⑧ **Compact Design** - Package size is the same regardless of ratio.

Space Tight? Turn Right

For space constrained applications, Parker's RS and RX right-angle gearheads offer as much as a 2X space savings compared to in-line products.

Generation II Stealth® Series

RX Generation II Performance Specifications

Parameter	Units	Ratio	RX60 Gen II		RX90 Gen II		RX115 Gen II	
Nominal Output Torque ¹⁾ $T_{nom r}$	Nm (in-lb)	5	10	(89)	44	(390)	68	(602)
		10	19	(168)	64	(566)	128	(566)
		15,20,25,50	24	(212)	66	(585)	136	(584)
		30,40,100	20	(177)	60	(530)	128	(531)
Maximum Acceleration Output Torque ²⁾ $T_{acc r}$	Nm (in-lb)	5	15	(133)	66	(584)	102	(903)
		10	28	(248)	96	(850)	128	(1132)
		15,20,25,50	36	(319)	100	(885)	136	(1203)
		30,40,100	30	(266)	90	(797)	128	(1132)
Emergency Stop Output Torque ³⁾ $T_{em r}$	Nm (in-lb)	5	32	(283)	120	(1062)	216	(1912)
		10	58	(513)	192	(1700)	384	(3398)
		15,20,25,50	64	(566)	200	(1770)	408	(3611)
		30,40,100	48	(425)	160	(1416)	345	(3053)
Nominal Input Speed $N_{nom r}$	RPM	5,10	3200		2800		2400	
		15,20,25,30,40	3700		3300		2900	
		50,100	4200		3800		3400	
Maximum Input Speed $N_{max r}$ ⁴⁾	RPM	5 – 100	6000		5300		4500	
Maximum Radial Load Pr_{max} ^{5, 7)}	N (lbs)		1550	(348)	2800	(1079)	5500	(1236)
Maximum Axial Load Pa_{max} ⁶⁾	N (lbs)		2100	(475)	3600	(810)	6800	(1530)
Service Life	h				20,000			
Standard Backlash ⁸⁾	arc-min	5 – 10	<20		<18		<16	
		15 – 100	<20		<18		<16	
Low Backlash ⁸⁾	arc-min	5 – 10	<18		<16		<14	
		15 – 100	<16		<14		<12	
Efficiency at Nominal Torque	%	5 – 100	94		94		94	
Noise Level at 3000 RPM ⁹⁾	db	5 – 100	<65		<68		<68	
Torsional Stiffness	Nm/arc-min (in-lb/arc-min)	5 – 100	2.5	(22)	10	(90)	22	(195)
Maximum Allowable Case Temperature	° C	5 – 100			-20 to 90			
Lubrication		5 – 100			Per Maintenance Schedule			
Mounting Position		5 – 100			Any			
Degree of Protection					IP65			
Maximum Weight	kg (lbs)	5 – 100	2.0	(4.4)	6.0	(13.2)	11.0	(24.2)

1) At nominal speed $N_{nom r}$.

2) Parker MotionSizer sizing software available for free download at parkermotion.com.

3) Maximum of 1000 stops.

4) For intermittent operation.

5) Max radial load applied to the center of the shaft at 100 rpm.

6) Max axial load at 100 rpm.

7) For combined radial and axial load consult factory.

8) Measured at 2% of rated torque.

9) Measure at 1m.

RX Generation II Output Shaft Load Rating

RX60 / RX23

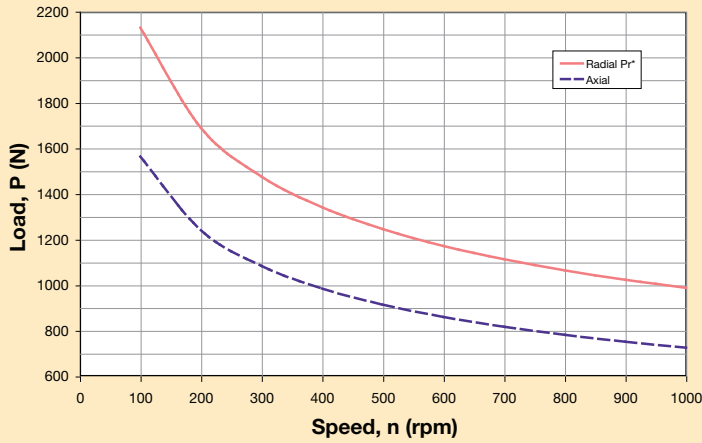

Formulas to calculate radial load (Prx) at any distance "X" from the gearhead mounting surface:

$$Pr_x = Pr * 78 \text{ mm} / (63 + X)$$

$$Pr_x = Pr * 3.07 \text{ in} / (2.48 \text{ in} + X)$$

RX90 / RX34

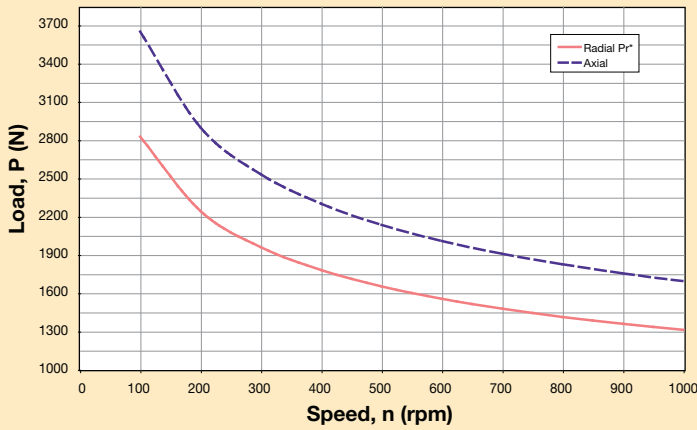

$$Pr_x = Pr * 95 \text{ mm} / (73 + X)$$

$$Pr_x = Pr * 3.74 \text{ in} / (2.87 \text{ in} + X)$$

RX115 / RX42

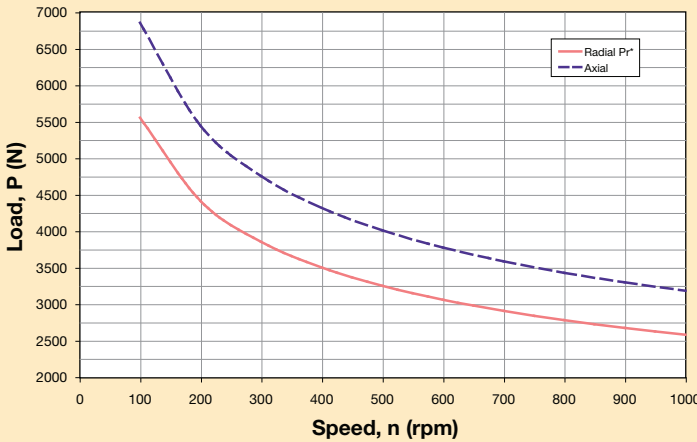

$$Pr_x = Pr * 115 \text{ mm} / (73 + X)$$

$$Pr_x = Pr * 4.53 \text{ in} / (3.43 \text{ in} + X)$$

* Radial load applied to center of the shaft.

Generation II Stealth® Series

RX Generation II Dimensions

Free 3D Solid Models and drawings available at parkermotion.com

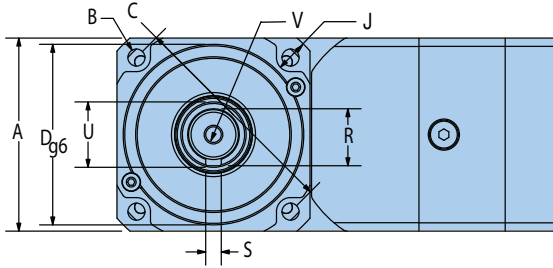

RX Gearheads also available with Flange Mount Option – Contact Factory

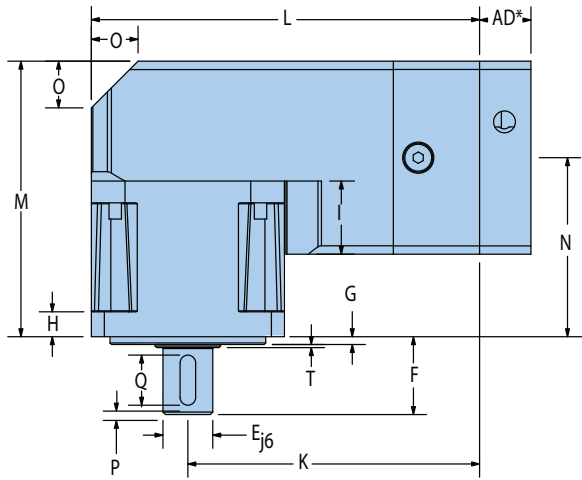

Metric Frame Sizes

Frame Size	A		B		C		D		E		F		G		H		I		J		K	
	Square Flange		Bolt Hole		Bolt Circle		Pilot Diameter		Output Shaft Diameter		Output Shaft Length		Pilot Thickness		Flange Thickness		Recess Length		Housing Recess		Distance to Output Centerline	
	mm	in	mm	in	mm	in	mm	in	mm	in	mm	in	mm	in	mm	in	mm	in	mm	in	mm	in
RX60	62	2.441	5.5	0.217	70	2.756	50	1.969	16	0.630	25	0.984	2.5	0.098	13	0.512	23.5	0.925	5	0.197	93.7	3.689
RX90	90	3.543	6.5	0.256	100	3.937	80	3.150	20	0.787	40	1.575	3	0.118	17	0.669	36.5	1.437	6.5	0.256	132	5.197
RX115	115	4.528	8.5	0.335	130	5.118	110	4.331	24	0.945	50	1.969	3.5	0.138	20	0.787	47.5	1.870	7.5	0.295	153.5	6.043

Frame Size	L		M		N		O		P		Q		R		S		T		U		V	
	Housing Length		Housing Width		Distance to Input Centerline		Taper Distance		Distance from Shaft End		Keyway Length		Keyway Key Height		Keyway Width		Shoulder Height		Shoulder Diameter		Tap & Depth (end of shaft)	
	mm	in	mm	in	mm	in	mm	in	mm	in	mm	in	mm	in	mm	in	mm	in	mm	in	mm	in
RX60	124.5	4.902	88.5	3.484	57.5	2.264	14	0.551	3	0.118	16	0.630	18	0.709	5	0.197	0.5	0.020	21	0.827	M5x8	
RX90	177	6.969	114	4.469	68.5	2.697	25	0.984	5	0.197	28	1.102	24.5	0.965	6	0.236	0.5	0.020	29	1.142	M8x16	
RX115	211	8.307	138	5.445	81	3.189	32	1.260	7	0.276	32	1.260	27	1.063	8	0.315	1	0.039	36	1.417	M8x16	

NEMA Frame Sizes

Frame Size	B		C		D		E		F		Q		R		S	
	Bolt Hole		Bolt Circle		Pilot Diameter		Output Shaft Diameter		Output Shaft Length		Keyway Length		Keyway Depth		Keyway Width	
	in	mm	in	mm	in	mm	in	mm	in	mm	in	mm	in	mm	in	mm
RX23	0.2	4.953	2.625	66.675	1.5	38.100	0.38	9.525	1	25.400	—	—	—	—	—	—
RX34	0.22	5.512	3.88	98.425	2.88	73.025	0.5	12.700	1.25	31.750	1.06	27.000	0.07	1.829	0.13	3.251
RX42	0.28	7.137	4.95	125.730	2.19	55.550	0.63	15.875	1.5	38.100	1.14	29.007	0.09	2.388	0.19	4.775

RX23 has a flat on output shaft, not a keyway

NOTE: NEMA Sizes have 20% lower torque/stiffness ratings due to smaller output shaft diameter.

RX Generation II Universal Mounting Kits*

Adapter Length "AD" Dimension

Frame Size	Motor Shaft Length		Gearhead Adapter Length	
	mm	in	mm	in
60	16 – 35	0.630 – 1.378	16.5	0.65
	35.1 – 41	1.382 – 1.614	22.5	0.886
90	20 – 40	0.787 – 1.575	20	0.787
	40.1 – 48	1.579 – 1.890	28.5	1.122
115	22 – 50	0.866 – 1.969	24	0.945
	50.1 – 61	1.972 – 2.402	35	1.378

* Know your motor and need our mounting kit part number? See page 29 or use our Motor Mounting Search Tool on our website at: www.parkermotion.com

RX Generation II Inertia

All moment of inertia values are as reflected at the input of the gearhead

Ratio	Units*	RX60 / RX23	RS90 / RX34	RS115 / RX42
5	kg-cm ²	0.2200	0.8100	2.5000
	in-lb-sec ²	0.000195	0.000717	0.002213
10	kg-cm ²	0.1900	0.6100	1.9000
	in-lb-sec ²	0.000168	0.000540	0.001682
15	kg-cm ²	0.1800	0.6000	1.7000
	in-lb-sec ²	0.150000	0.000531	0.001505
20	kg-cm ²	0.1700	0.5100	1.4000
	in-lb-sec ²	0.000150	0.000451	0.001239
25	kg-cm ²	0.1600	0.4200	1.3000
	in-lb-sec ²	0.000142	0.000372	0.001151
30	kg-cm ²	0.1800	0.6000	1.7000
	in-lb-sec ²	0.000159	0.000531	0.001505
40	kg-cm ²	0.1700	0.5100	1.4000
	in-lb-sec ²	0.000150	0.000451	0.001239
50	kg-cm ²	0.1500	0.4000	1.1000
	in-lb-sec ²	0.000133	0.000354	0.000974
100	kg-cm ²	0.1500	0.4000	1.1000
	in-lb-sec ²	0.000133	0.000354	0.000974

* Note: 1 kg-cm² = 0.000885 in-lb-sec²

Generation II Stealth® Series

Generation II Stealth® How to Order

Choose gearhead series, frame size, ratio, backlash and specify motor, make and model for mounting kit from the charts below and on the following page.

Sizing/Selection Design Assistance

To properly size and select a gearhead for a specific application requires consideration of several interrelated parameters including: speed, continuous torque, repetitive peak torque or acceleration torque, emergency stop torque, duty cycle, ambient temperature and radial and axial shaft load.

The 9 step procedure on pages 72-73 provides a straightforward method of selecting the correct gearhead for your application.

Gearhead Ordering Information

Order Example:		①	②	-	③	-	④	-	⑤	⑥
		PS	60		003		XXX		S	2
①	②	③			④			⑤		⑥
Series	Frame Size	Ratio		Special Options*			Backlash	GEN 2 Identifier		
PS	60, 90, 115, 142	003, 004, 005, 007, 010, 015, 020, 025, 030, 040, 050, 070, 100		XXX = Factory issued						
PX	60, 90, 115, 23, 34, 42	003, 004, 005, 007, 010, 015, 020, 025, 030, 040, 050, 070, 100		XXX = Factory issued T01 = Flange Mount			S = Standard L = Low	2		
RS	60, 90, 115, 142	005, 010, 015, 020, 025, 030, 040, 050, 100		XXX = Factory issued						
RX	60, 90, 115, 23, 34, 42	005, 010, 015, 020, 025, 030, 040, 050, 100		XXX = Factory issued (Contact factory for Flange Mount Option)						

* Standard special options include: F01 Food Grade, W01 Washdown, G01 GenI Spacer Plate, L02 No lubricant (standard is oil filled), V01 Vacuum, C01 CleanRoom Class 10,000. Leave blank if no special option required.

Motor Mounting How to Order

Know your motor and need our mounting kit part number? Use the charts below or use our Motor Mounting Search Tool on our website at:

www.parkermotion.com

Order Example:	⑦	MU	⑧	60	-	XXX
-----------------------	---	----	---	----	---	-----

⑦	⑧	
Universal Mounting*	Frame Size **	Mounting Kit Suffix Number
MU	60, 90, 115	See Motor Mounting Selection Tool on our website at: www.parkermotion.com

* Common to PS, PX, RS and RX Series Gearheads
 **PX/RX23 use MU60, PX/RX34 use MU90, PX/RX42 use MU115

Universal Mounting Kit Adapter Length “AD” Dimension

Frame Size	Motor Shaft Length		Gearhead Adapter Length	
	mm	in	mm	in
60	16 – 35	0.630 – 1.378	16.5	0.65
	35.1 – 41	1.382 – 1.614	22.5	0.886
90	20 – 40	0.787 – 1.575	20	0.787
	40.1 – 48	1.579 – 1.890	28.5	1.122
115	22 – 50	0.866 – 1.969	24	0.945
	50.1 – 61	1.972 – 2.402	35	1.378
142	26 – 62	1.023 – 2.44	30	1.181
	46 – 82	1.811 – 3.23	50	1.969

Recommended Parker Motor and Mounting Kit

Frame Size	Recommended Servo Motor			Recommended Stepper Motor		
	Motor	Mounting Kit	AD Dimension	Motor	Mounting Kit	AD Dimension
60 or 23	BE23 SM23	MU60-033	16.5 mm	LV23 HV23	MU60-005	16.5 mm
90 or 34	MPP092 BE34	MU90-092 MU90-005	20 mm	LV34 HV34	MU90-005	20 mm
115 or 42	MPP100 MPP115	MU-115-039 MU115-010	24 mm			
142	MPP115 MPP142	MU142-010 Mu142-146	30 mm			