

General Description

Series R4R*P2 subplate mounted proportional pressure reducing valves have a proportional solenoid operated pilot stage and a cartridge main stage.

The optimum performance can be achieved in combination with the digital amplifier module PCD00A-400.

Features

- Pilot operated with proportional solenoid.
- Continuous adjustment by proportional solenoid.
- Subplate mounting according to ISO 5781.
- 3 pressure ranges.
- Mechanical maximum pressure adjustment.

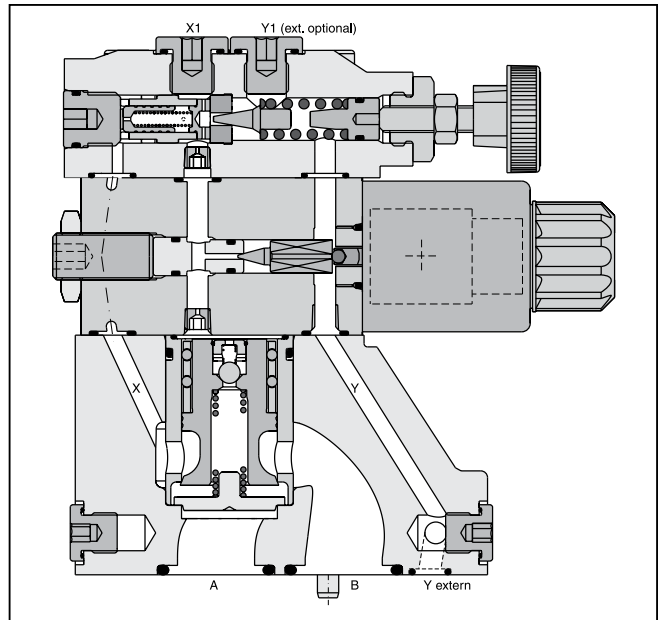
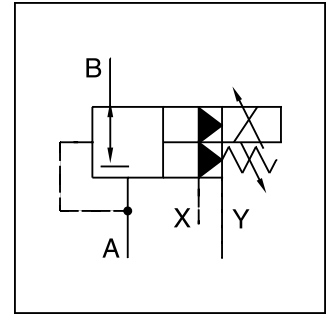

Ordering Information

<div style="border: 1px solid black; padding: 2px; width: 30px; margin: 0 auto;">R</div> <p>Pressure Reducing Valve</p>	<div style="border: 1px solid black; padding: 2px; width: 30px; margin: 0 auto;">4</div> <p>Interface</p>	<div style="border: 1px solid black; padding: 2px; width: 30px; margin: 0 auto;">R</div> <p>Reducing Function</p>	<div style="border: 1px solid black; padding: 2px; width: 30px; margin: 0 auto;">5</div> <p>Maximum Pressure 350 Bar (5075 PSI)</p>	<div style="border: 1px solid black; padding: 2px; width: 30px; margin: 0 auto;">9</div> <p>Pilot Ports G1/4"</p>	<div style="border: 1px solid black; padding: 2px; width: 30px; margin: 0 auto;">P2</div> <p>Proportional Pressure Control</p>	<div style="border: 1px solid black; padding: 2px; width: 30px; margin: 0 auto;">G0R</div> <p>Solenoid Voltage 12V 2.3A</p>	<div style="border: 1px solid black; padding: 2px; width: 30px; margin: 0 auto;">B</div> <p>Design Series</p>	<div style="border: 1px solid black; padding: 2px; width: 30px; margin: 0 auto;">Seal</div> <p>Options Check with Factory</p>																						
		<table border="1" style="margin: 0 auto;"> <thead> <tr> <th>Code</th> <th>Description</th> </tr> </thead> <tbody> <tr> <td>03</td> <td>NG10</td> </tr> <tr> <td>06</td> <td>NG25</td> </tr> <tr> <td>10</td> <td>NG32</td> </tr> </tbody> </table>		Code	Description	03	NG10	06	NG25	10	NG32	<table border="1" style="margin: 0 auto;"> <thead> <tr> <th>Code</th> <th>Pilot</th> <th>Drain</th> </tr> </thead> <tbody> <tr> <td>1</td> <td>Internal</td> <td>External from Y</td> </tr> <tr> <td>2</td> <td>Internal</td> <td>External from Y1</td> </tr> </tbody> </table>		Code	Pilot	Drain	1	Internal	External from Y	2	Internal	External from Y1	<table border="1" style="margin: 0 auto;"> <thead> <tr> <th>Code</th> <th>Description</th> </tr> </thead> <tbody> <tr> <td>1</td> <td>Nitrile</td> </tr> <tr> <td>5</td> <td>Fluorocarbon</td> </tr> </tbody> </table>		Code	Description	1	Nitrile	5	Fluorocarbon
Code	Description																													
03	NG10																													
06	NG25																													
10	NG32																													
Code	Pilot	Drain																												
1	Internal	External from Y																												
2	Internal	External from Y1																												
Code	Description																													
1	Nitrile																													
5	Fluorocarbon																													
<table border="1" style="margin: 0 auto;"> <thead> <tr> <th>Code</th> <th>Description</th> </tr> </thead> <tbody> <tr> <td>4</td> <td>Subplate Mounting ISO 5781</td> </tr> </tbody> </table>		Code	Description	4	Subplate Mounting ISO 5781	<table border="1" style="margin: 0 auto;"> <thead> <tr> <th>Code</th> <th>Description</th> </tr> </thead> <tbody> <tr> <td>1</td> <td>Hand Knob 32mm dia. Standard</td> </tr> <tr> <td>3</td> <td>Acorn Nut with Lead Seal</td> </tr> </tbody> </table>		Code	Description	1	Hand Knob 32mm dia. Standard	3	Acorn Nut with Lead Seal	<p>Bolt Kit:</p> <table border="0"> <tr> <td>R4R03*P2</td> <td>BK505</td> </tr> <tr> <td>R4R06*6*P2</td> <td>BK485</td> </tr> <tr> <td>R4R10*P2</td> <td>BK506</td> </tr> </table>		R4R03*P2	BK505	R4R06*6*P2	BK485	R4R10*P2	BK506									
Code	Description																													
4	Subplate Mounting ISO 5781																													
Code	Description																													
1	Hand Knob 32mm dia. Standard																													
3	Acorn Nut with Lead Seal																													
R4R03*P2	BK505																													
R4R06*6*P2	BK485																													
R4R10*P2	BK506																													
<table border="1" style="margin: 0 auto;"> <thead> <tr> <th>Code</th> <th>Description</th> </tr> </thead> <tbody> <tr> <td>1</td> <td>up to 105 Bar (1523 PSI)</td> </tr> <tr> <td>3</td> <td>up to 210 Bar (3045 PSI)</td> </tr> <tr> <td>5</td> <td>up to 350 Bar (5075 PSI)</td> </tr> </tbody> </table>		Code	Description	1	up to 105 Bar (1523 PSI)	3	up to 210 Bar (3045 PSI)	5	up to 350 Bar (5075 PSI)	<p>Weight:</p> <table border="0"> <tr> <td>R4R03*P2</td> <td>2.7 kg (6.0 lbs.)</td> </tr> <tr> <td>R4R06*6*P2</td> <td>4.5 kg (9.9 lbs.)</td> </tr> <tr> <td>R4R10*P2</td> <td>6.0 kg (13.2 lbs.)</td> </tr> </table>		R4R03*P2	2.7 kg (6.0 lbs.)	R4R06*6*P2	4.5 kg (9.9 lbs.)	R4R10*P2	6.0 kg (13.2 lbs.)													
Code	Description																													
1	up to 105 Bar (1523 PSI)																													
3	up to 210 Bar (3045 PSI)																													
5	up to 350 Bar (5075 PSI)																													
R4R03*P2	2.7 kg (6.0 lbs.)																													
R4R06*6*P2	4.5 kg (9.9 lbs.)																													
R4R10*P2	6.0 kg (13.2 lbs.)																													

Specifications

General				
Size		NG10	NG25	NG32
Interface	Subplate mounting acc. ISO 5781			
Mounting Position	as desired, horizontal mounting preferred			
Ambient Temperature	[°C]	-20 ... +80; (-4°F ... +176°F)		
MTTF _D Value	[years]	75		
Hydraulic				
Maximum Operating Pressure	Ports A, B and X 350 Bar (5075 PSI), Port Y depressurized			
Pressure Ranges	105 Bar (1523 PSI), 210 Bar (3045 PSI), 350 Bar (5075 PSI)			
Nominal Flow		150 LPM (39.7 GPM)	350 LPM (92.6 GPM)	500 LPM (132.3 PSI)
Fluid	Hydraulic oil according to DIN 51524 ... 525			
Viscosity Recommended Permitted	[cSt] / [mm ² /s]	30 ... 50 (139 ... 232 SSU)		
	[cSt] / [mm ² /s]	20 ... 380 (93 ... 1761 SSU)		
Fluid Temperature	[°C]	-20 ... +70 (-4°F ... +158°F)		
Filtration	ISO 4406 (1999) 18/16/13			
Electrical				
Duty Ratio	[%]	100 ED		
Protection Class	IP65 in accordance with EN 60529 (plugged and mounted)			
Nominal Voltage	[V]	12		
Maximum Current	[A]	2.3		
Coil Resistance	[Ohm]	4 at 20°C (68°F)		
Solenoid Connection	Connector as per EN 175301-803			
Power Amplifier, Recommended	PCD00A-400			

Performance Curves

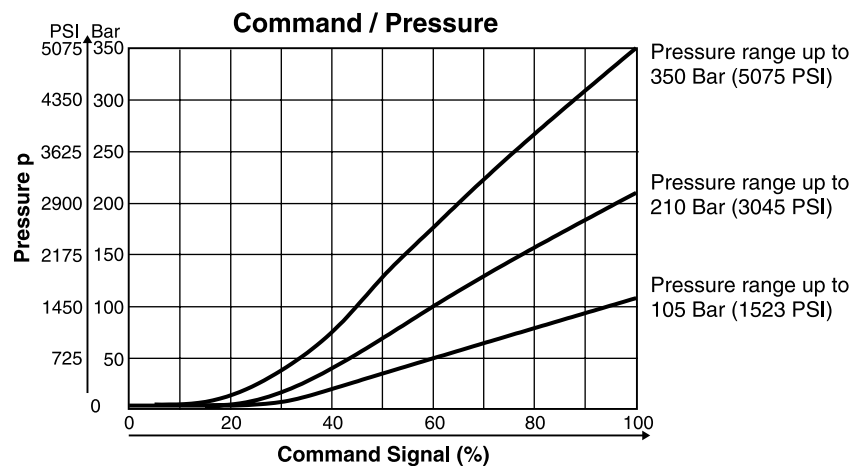

R4R03*P2 ¹⁾

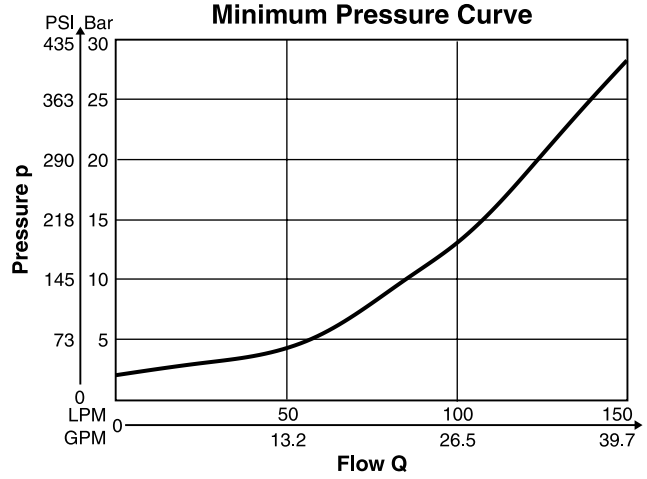
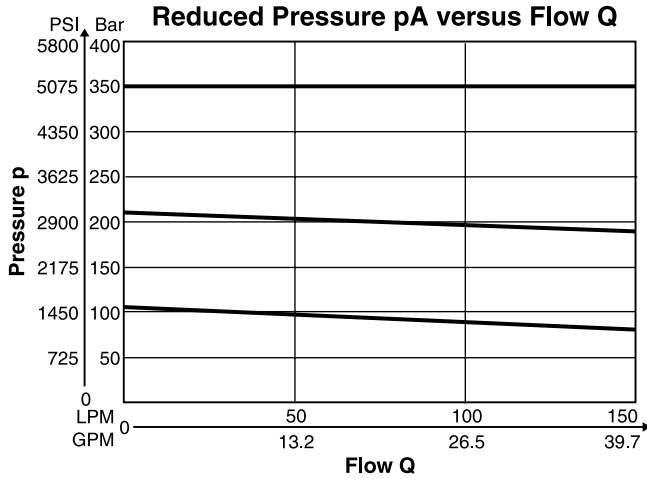

R4R06*P2 ¹⁾

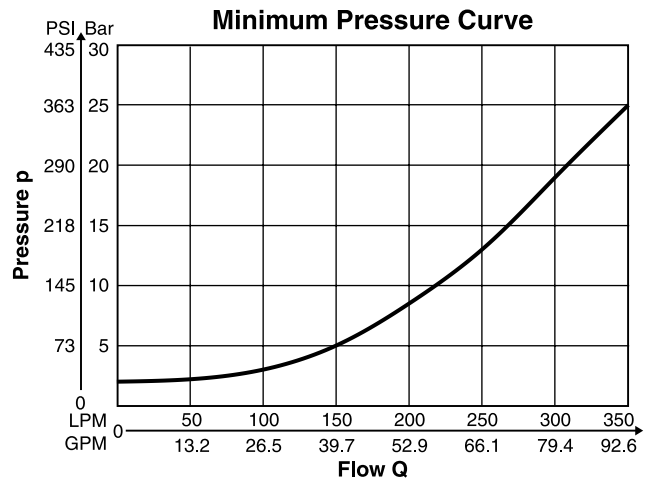
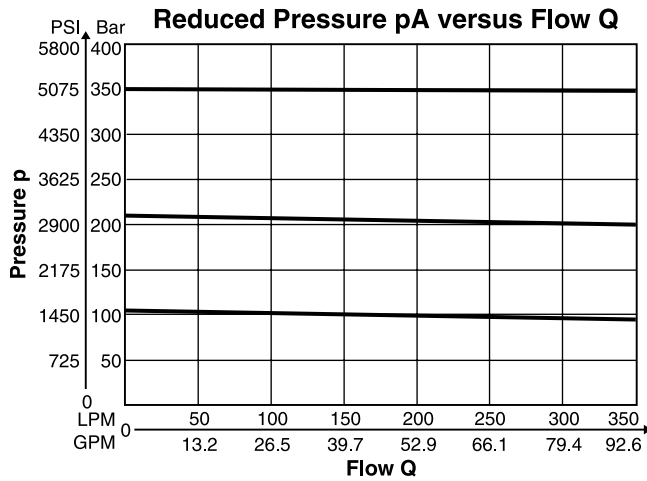

R4R10*P2 ¹⁾

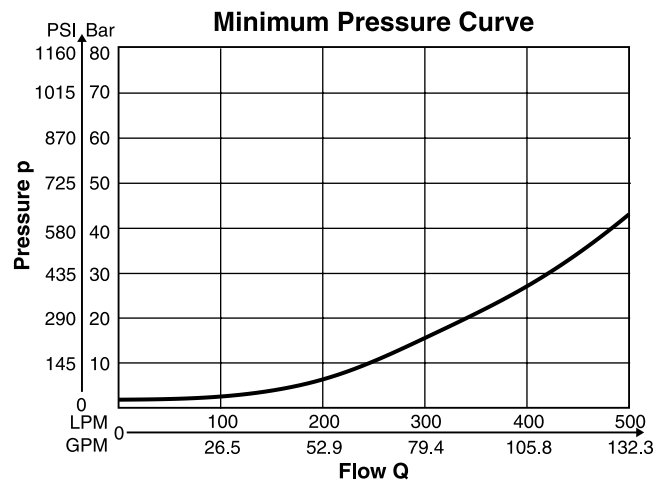
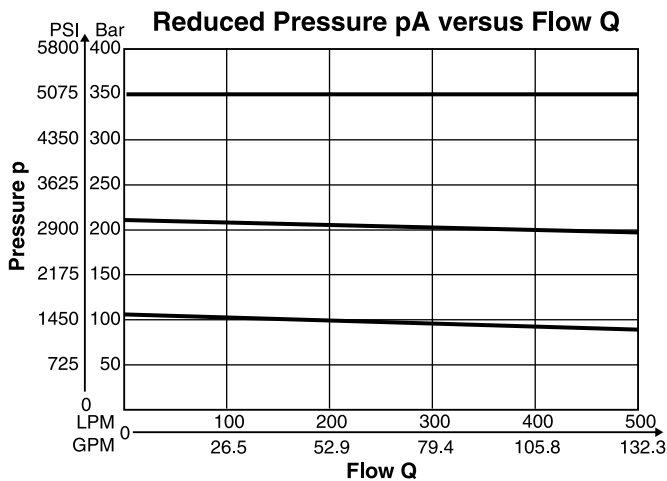

¹⁾ Measured at 350 Bar (5075 PSI) primary pressure pB.

B

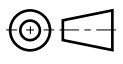
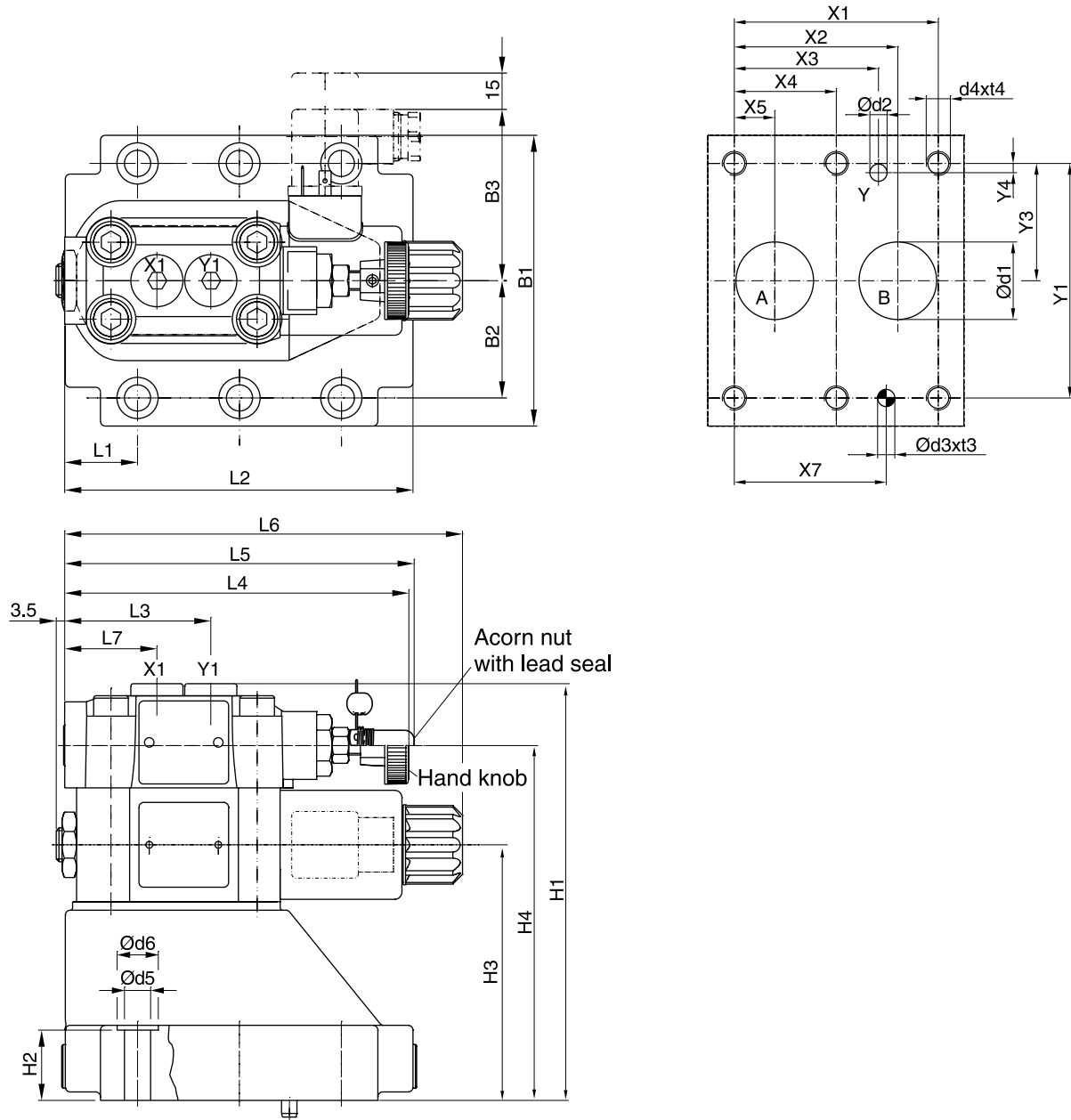



Inch equivalents for millimeter dimensions are shown in (**)

NG	ISO-Code	x1	x2	x3	x4	x5	x6	x7	y1	y2	y3	y4	y5	y6
10	5781-06-07-0-00	42.9 (1.69)	35.8 (1.41)	21.5 (0.85)	-	7.2 (0.28)	-	31.8 (1.25)	66.7 (2.63)	-	33.4 (1.31)	7.9 (0.31)	-	-
25	5781-08-10-0-00	60.3 (2.37)	49.2 (1.94)	39.7 (1.56)	-	11.1 (0.44)	-	44.5 (1.75)	79.4 (3.13)	-	39.7 (1.56)	6.4 (0.25)	-	-
32	5781-10-13-0-00	84.2 (3.31)	67.5 (2.66)	59.5 (2.34)	42.1 (1.66)	16.7 (0.66)	-	62.7 (2.47)	96.8 (3.81)	-	48.4 (1.91)	3.8 (0.15)	-	-

Tolerance at X and Y pin holes and screw holes ±0.1, at port holes ±0.2.

NG	ISO-Code	B1	B2	B3	H1	H2	H3	H4	L1	L2	L3	L4	L5	L6	L7
10	5781-06-07-0-00	87.3 (3.44)	33.4 (1.31)	71.0 (2.80)	134.0 (5.28)	21.0 (0.83)	68.5 (2.70)	109.5 (4.31)	29.0 (1.14)	94.8 (3.73)	60.8 (2.38)	143.0 (5.63)	144.8 (5.70)	164.0 (6.49)	38.6 (1.52)
25	5781-08-10-0-00	105.0 (4.13)	39.7 (1.56)	71.0 (2.80)	160.5 (6.32)	29.0 (1.14)	95.0 (3.74)	136.0 (5.35)	34.7 (1.37)	126.8 (4.99)	60.8 (2.38)	143.0 (5.63)	144.8 (5.70)	164.0 (6.49)	38.6 (1.52)
32	5781-10-13-0-00	120.0 (4.72)	48.4 (1.91)	71.0 (2.80)	171.0 (6.73)	29.0 (1.14)	105.5 (4.15)	146.5 (5.77)	30.6 (1.20)	144.3 (5.68)	60.8 (2.38)	143.0 (5.63)	144.8 (5.70)	164.0 (6.49)	38.6 (1.52)

NG	ISO-Code	d1max	d2max	d3	t3	d4	t4	d5	d6	Subplate
10	5781-06-07-0-00	15.0 (0.59)	7.0 (0.28)	7.1 (0.28)	8.0 (0.31)	M10	16.0 (0.63)	10.8 (0.43)	17.0 (0.67)	SPP3M6B910
25	5781-08-10-0-00	23.4 (0.92)	7.1 (0.28)	7.1 (0.28)	8.0 (0.31)	M10	18.0 (0.71)	10.8 (0.43)	17.0 (0.67)	SPP6M8B910
32	5781-10-13-0-00	32.0 (1.26)	7.1 (0.28)	7.1 (0.28)	8.0 (0.31)	M10	20.0 (0.79)	10.8 (0.43)	17.0 (0.67)	SPP10M12B910

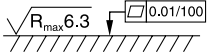
NG	ISO-Code	Bolt Kit			Seal Kit		Surface Finish
					Nitrile	Fluorocarbon	
10	5781-06-07-0-00	BK505	4x M10 x 35 DIN912 12.9	63 Nm (46.5 lb.-ft.) ±15%	S26-58507-0*	S26-58507-5*	
25	5781-08-10-0-00	BK485	4x M10 x 45 DIN912 12.9	63 Nm (46.5 lb.-ft.) ±15%	S26-58475-0*	S26-58475-5*	
32	5781-10-13-0-00	BK506	6x M10 x 45 DIN912 12.9	63 Nm (46.5 lb.-ft.) ±15%	S26-58508-0*	S26-58508-5*	
Prop. Section P2					S26-58473-0	S26-58473-5	

* Please combine seal kit of one size with seal kit of Prop. Section P2 for complete seal kit

