



CV Series Check Valves Offer Low Pressure Drop and High Flow.

Parker's CV Series check valves are a rugged built and versatile product designed to protect hydraulic systems from fluid back pressure. The CV Series compliments the DT Series by adding the feature of modular design. The larger body results in less pressure drop and increased performance. The CV Series are in-line unidirectional valves, available in sizes 1/4" to 1", with a pressure rating of up to 3000 PSI, and flow capacities to 100 GPM. Standard spring crack pressures are 5 and 65 PSI. Other crack pressures available upon request.

Features

1. Nitrile O-ring is standard in the body assembly. Note port O-rings are included on the MO and MS ports.
2. All-steel construction
3. Valve seats resist damage from shocks, surges and contamination.
4. Poppet has an oil retention groove that lubricates the bore and eliminates galling.
5. Poppet spring is isolated from the liquid flow stream, minimizing turbulence.
6. Poppet is heat treated to help prevent damage from shocks, surges and galling.
7. Close tolerance fit between poppet and poppet retainer creates a cushion that protects valve from surge shock damage.
8. Optional crack pressures available upon request.

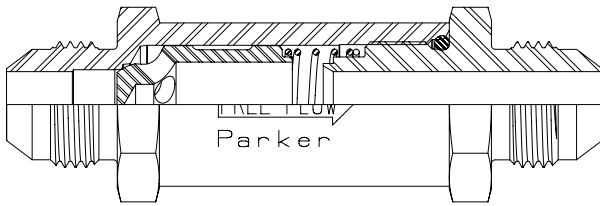
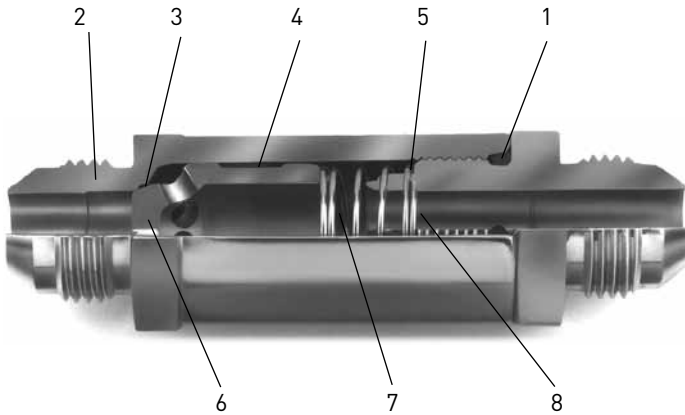

CV-MFMF
Male Flare 37° JIC Inlet to Male Flare 37° JIC Outlet

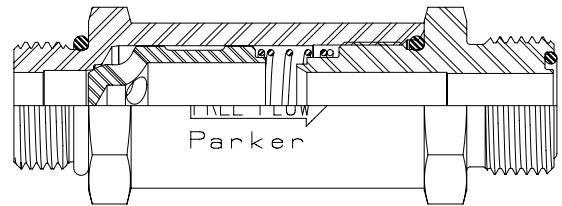

CV-MOMS
Male O-Ring Boss Inlet to Male Seal-Lok® Outlet

NOTE: Contact QCD for additional port end options.

CV-MFMF Male Flare 37° JIC Inlet to Male Flare 37° JIC Outlet

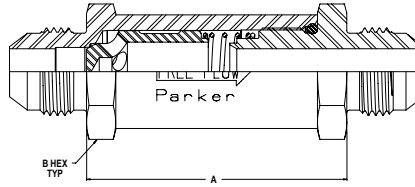

Valve Size	Part Number	Inlet Port Thread	Dimensions (in.)		Outlet Port Thread	** Std Crack Pressure (psi)	Max Operating Pressure (psi)
			Length	Wrench Flats			
			A	B			
1/4	CV-250-MFMF-**	7/16-20 UNF	1.53	.68	7/16-20 UNF	5, 65	3000
3/8	CV-370-MFMF-**	9/16-18 UNF	1.75	.81	9/16-18 UNF	5, 65	3000
1/2	CV-500-MFMF-**	3/4-16 UNF	2.22	1.00	3/4-16 UNF	5, 65	3000
5/8	CV-620-MFMF-**	7/8-14 UNF	2.41	1.12	7/8-14 UNF	5, 65	3000
3/4	CV-750-MFMF-**	1-1/16-12 UN	2.75	1.38	1-1/16-12 UN	5, 65	3000
1	CV-1000-MFMF-**	1-5/16-12 UN	3.31	1.62	1-5/16-12 UN	5, 65	3000

CV-MOMS Male O-Ring Boss Inlet to Male Seal-Lok® Outlet

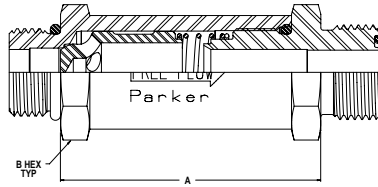

Valve Size	Part Number	Inlet Port Thread	Dimensions (in.)		Outlet Port Thread	** Std Crack Pressure (psi)	Max Operating Pressure (psi)
			Length	Wrench Flats			
			A	B			
1/4	CV-250-MOMS-**	7/16-20 UNF	1.53	.68	9/16-18 UNF	5, 65	3000
3/8	CV-370-MOMS-**	9/16-18 UNF	1.75	.81	11/16-16 UN	5, 65	3000
1/2	CV-500-MOMS-**	3/4-16 UNF	2.22	1.00	13/16-16 UN	5, 65	3000
5/8	CV-620-MOMS-**	7/8-14 UNF	2.41	1.12	1-14 UNS	5, 65	3000
3/4	CV-750-MOMS-**	1-1/16-12 UN	2.75	1.38	1-3/16-12 UN	5, 65	3000
1	CV-1000-MOMS-**	1-5/16-12 UN	3.31	1.62	1-7/16-12 UN	5, 65	3000

E Valves

Flow Data

CV Series (1/4" & 3/8")
Test Fluid: Oil - 200 SUS

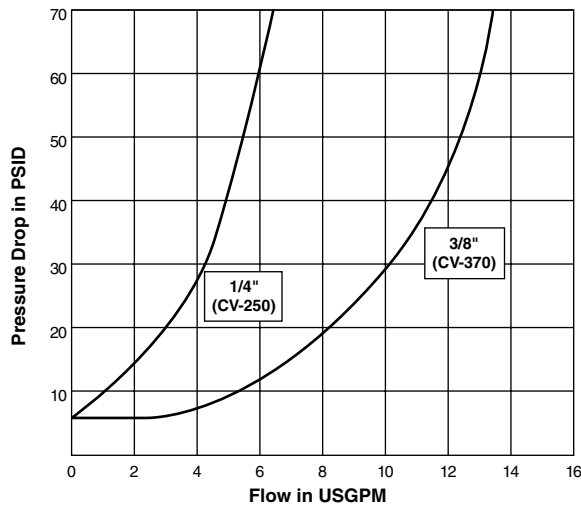

CV Series (1/2", 5/8", 3/4" & 1")
Test Fluid: Oil - 200 SUS

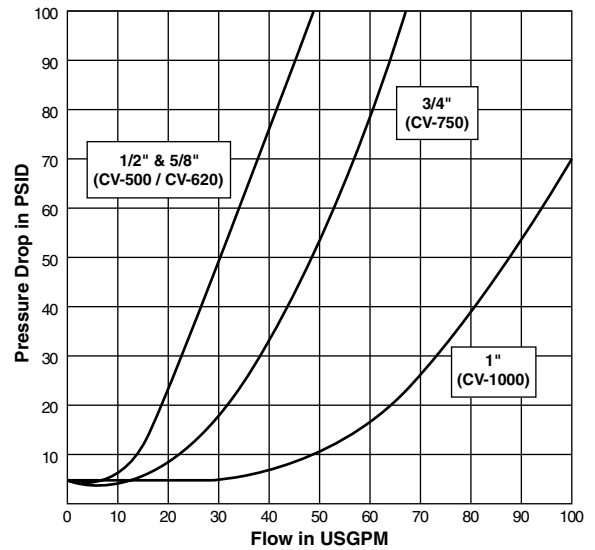

Ordering Information

C V - * * * - * * * * - * *

CRACK PRESSURE
 5 - 5 PSI
 65 - 65 PSI
 Other Crack Pressures up to 200 PSI in 5 PSI increments are available. Contact the Division for price and delivery on non-standard crack pressures

SERIES	SIZE	FITTING STYLE
250	1/4"	MFMF - Male Flare Inlet to Male Flare Outlet
370	3/8"	MOMS - Male O-Ring Boss Inlet to Male Seal-Lok® Outlet
500	1/2"	
620	5/8"	
750	3/4"	
1000	1"	

NOTE: Contact QCD for additional port end options.