

	SERIES	CAVITY	DESCRIPTION	FLOW LPM/GPM	PRESSURE BAR/PSI	PAGE NO.
	PRESSURE RELIEVING					
	AP01B2YP	2G	Increase Pressure/Increase Current	5.3/1.4	350/5000	PV7-PV8
	AP02B2YP	C08-2	Increase Pressure/Increase Current	5.3/1.4	350/5000	PV9-PV10
	AP04G2YP	C10-2	Increase Pressure/Increase Current	45/12	350/5000	PV11-PV12
	<hr/>					
	AP01B2YR	2G	Decrease Pressure/Increase Current	5.3/1.4	350/5000	PV13-PV14
	AP02B2YR	C08-2	Decrease Pressure/Increase Current	5.3/1.4	350/5000	PV15-PV16
	AP04G2YR	C10-2	Decrease Pressure/Increase Current	95/25	350/5000	PV17-PV18
	<hr/>					
	PRESSURE REDUCING					
	GP01 30	54-1	Pressure Reducing Valve	1.9/5	210/3000	PV19-PV20
	GTP02 34	C08-3	Pressure Reducing Valve	19/5	210/3000	PV21-PV22
	GTP04 34	3X	Pressure Reducing Valve	30/8	210/3000	PV23-PV24
<hr/>						
	FLOW CONTROLS, 2-Way					
	DF122C	C12-2	Flow Control, N.C.	53/14	210/3000	PV25-PV26
	DF161C	C16-2	Flow Control, N.C.	150/40	210/3000	PV27-PV28
	DF201C	C20-2	Flow Control, N.C.	325/60	210/3000	PV29-PV30
	HP02C	2X	Flow Control, N.C.	23/6	210/3000	PV31-PV32
	JP02C	C08-3	Flow Control, N.C.	23/6	210/3000	PV33-PV34
	HP04C	C10-2	Flow Control, N.C.	36/9.5	210/3000	PV35-PV36
	JP04C 21	3X	Flow Control, N.C.	36/9.5	210/3000	PV37-PV38
	DFA125C21*	C12-3L	Flow Control, N.C.	56.8/15	210/3000	PV39-PV40
	<i>*The DFA125C21 will be available January 1, 2011.</i>					
	HP02P	2X	Flow Control, N.O.	19/5	210/3000	PV41-PV42
	JP02P	C08-3	Flow Control, N.O.	19/5	210/3000	PV43-PV44
	HP04P	C10-2	Flow Control, N.O.	30/8	210/3000	PV45-PV46
	JP04P	3X	Flow Control, N.O.	36/9.5	210/3000	PV47-PV48
	DF122N	C12-2	Flow Control, N.O.	53/14	210/3000	PV49-PV50
<hr/>						
	FLOW CONTROLS, 3-WAY					
	JP04C 31	4C	Priority Flow Control, N.C.	30/8	210/3000	PV51-PV52
	DFA125C31	C12-4L	Priority Flow Control, N.C.	56.8/15	210/3000	PV53-PV54
<hr/>						
	DIRECTIONAL CONTROL					
	GP02 51	C08-4	4 Way, 3 Pos - Closed Center	21/5.5	350/5000	PV55-PV56
	GP02 53	C08-4	4 Way, 3 Pos - Float Center	17/4.5	350/5000	PV57-PV58
	DSP105C1	C10-4	4 Way, 3 Pos - Closed Center	32/8.5	210/3000	PV59-PV61
	DSP105C4	C10-4	4 Way, 3 Pos - Float Center	32/8.5	210/3000	PV59-PV61

CV
Check Valves
SH
Shuttle Valves
LM
Load/Motor Controls
FC
Flow Controls
PC
Pressure Controls
LE
Logic Elements
DC
Directional Controls
MV
Manual Valves
SV
Solenoid Valves
PV
Proportional Valves
CE
Coils & Electronics
BC
Bodies & Cavities
TD
Technical Data



CV

Check
Valves

INTRODUCTION

This technical tips section is designed to help familiarize you with the Parker line of Proportional Valves. In this section we present common options, technical terms, as well as a brief synopsis of the operation and applications of the various products offered in this section. The intent of this section is to help you in selecting the best products for your application.

SH

Shuttle
Valves

LM

Load/Motor
Controls

COMMON OPTIONS

As you will see, Parker offers a variety of Proportional Valve products. As such, some of the options mentioned below may not be available on all valves. Consult the model coding and dimensions for each valve for specifics. Here are some of the common options available.

FC

Flow
Controls

Seals: The majority of the products are available in Nitrile or Fluorocarbon Seals. The Winner's Circle products feature a standard 4301 Polyurethane "D"-Ring. The "D"-Ring eliminates the need for backup rings. You should match the seal compatibility to the temperature and fluid being used in your application.

Overrides: Overrides are standard on many of the Parker proportional valves. The override is generally a push type that is flush with the end of the tube. Consult the individual catalog pages for more details.

PC

Pressure
Controls

LE

Logic
Elements

TECHNICAL TERMS

To help in applying our proportional valve line of product, we have listed some technical terms below, as well as some helpful hints in applying our valves.

DC

Directional
Controls

Ohm's Law: Electrical current is generated as a result of the relationship between input voltage and the resistance to the flow of electrical current. It is represented in equation form by $I = V/R$ (or $V=IR$), where I is current, V is voltage and R is resistance. This is an important relationship to remember when dealing with any electrically operated valves. Proportional valves allow varying control of flow or pressure, dependant on the current signal provided. As coils heat up, their resistance rises. This means a higher voltage must be available to maintain the same amount of pressure or flow. Thus, the application needs to be designed such that the full on position is about 70% of the initial current draw. On the individual catalog pages a maximum control current is specified to help in applying our proportional valves.

small back and forth movement of the valve spool around its set position. This rapid movement reduces the friction of the valve and leads to faster, more accurate response.

MV

Manual
Valves

SV

Solenoid
Valves

PV

Proportional
Valves

CE

Coils &
Electronics

PWM: Pulse Width Modulation (PWM) is the preferred signal for controlling electrical current. PWM is on / off voltage in a square wave form. The percent "on" time or duty cycle provides the average voltage. The valve driver adjusts the duty cycle to obtain current control. We recommend valve drivers with current control for optimum performance. PWM signals also usually provide dither for the proportional valve. Dither is a

PWM Frequency: The frequency of a PWM signal is the rate at which the signal is turned on and off. Parker's analog proportional valves are designed to work with low frequency responses between 100-400 Hz. The performance curves on our catalog pages were performed with a PWM signal at 200 Hz.

Hysteresis: Due to various factors, the performance of a proportional valve will show a slightly different performance when the current signal is increasing than it will when the signal is being decreased. This difference is usually expressed as a percentage of total input change and is referred to as the hysteresis of the valve.

BC

Bodies &
Cavities

TD

Technical
Data

Deadband: Cracking or deadband refers to the amount of the control signal that is needed to produce any movement of the spool. Thus, a 20% deadband means that 20% of the control signal is needed before the spool will move.

PRODUCT TYPES / APPLICATIONS

Proportional valves are nothing more than electrically adjustable hydraulic valves. They give the operator nearly infinite adjustment control and flexibility. Parker Hannifin offers various types of proportional flow control, pressure reducing, and relief valves.

Proportional Flow Control Valve

Proportional flow control valves provide pseudo pressure compensation and are used on systems requiring variable electronic control of flow. They allow the operator to vary the control signal to accelerate or decelerate an actuator. A compensator valve can be added to the circuit for enhanced compensation. Some typical applications would include the hoist control for a lift, or the speed control for a winch circuit. Parker offers both normally closed and normally open versions of proportional flow controls.

Normally Closed Proportional Flow Control

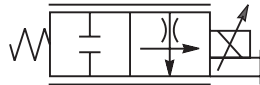

OPERATION - With the solenoid coil de-energized, the spool is held in a closed position by the spring force. When the solenoid coil is energized, the amperage of the signal moves the spool into an open position.

The spool is held in this position by a balance between spring force and electrical force. As the current increases, the spools opens further; allowing more flow. As the current decreases, the spool begins closing; allowing less flow. Pseudo compensation is obtained by the pressure drop across the orifices in the spool.

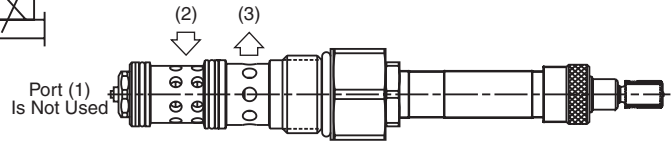

Normally Open Proportional Flow Control

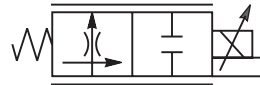

OPERATION - With the solenoid coil de-energized, the spool is held in an open position by spring force; allowing full flow to pass. As the solenoid coil is energized, the spool begins to move away from a full open position; allowing less flow to pass. Once a full electronic signal is given, the spool is held in a closed position; allowing no flow to pass. As the electronic signal is then reduced, the spool begins to open; allowing flow to pass again. Once a constant electronic signal is given, the spool is held in that position by a balance between electronic force and spring force. Pseudo compensation is obtained by the pressure drop across the orifices in the spool.

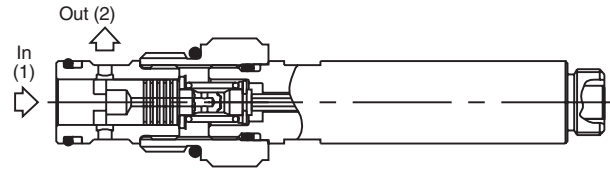

Normally Closed Proportional Needle Valve

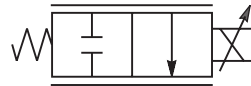

The proportional needle valves are electronic controlled variable needle valves. They are designed specifically for bleed off or unloading circuits as back pressure will affect performance.

OPERATION - With the solenoid de-energized, the main poppet is held in the closed position by spring force. When the solenoid is energized, the sensing spool moves into a partially open position relative to the percentage of rated current flowing through the coil. This action allows the main poppet to move away from the valve seat to a degree that corresponds to sensing spool position. The valve will maintain a fixed amount of opening as long as the electrical current remains constant and will vary proportionally with an increase or decrease in current.

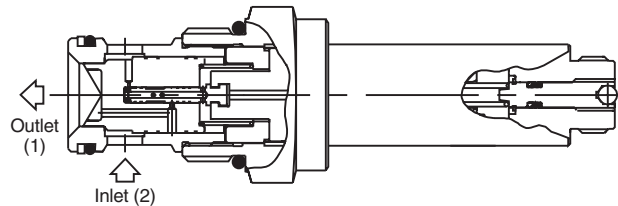

CV

Check Valves

SH

Shuttle Valves

LM

Load/Motor Controls

FC

Flow Controls

PC

Pressure Controls

LE

Logic Elements

DC

Directional Controls

MV

Manual Valves

SV

Solenoid Valves

PV

Proportional Valves

CE

Coils & Electronics

BC

Bodies & Cavities

TD

Technical Data

- CV** Check Valves
- SH** Shuttle Valves
- LM** Load/Motor Controls
- FC** Flow Controls
- PC** Pressure Controls
- LE** Logic Elements
- DC** Directional Controls
- MV** Manual Valves
- SV** Solenoid Valves
- PV** Proportional Valves
- CE** Coils & Electronics
- BC** Bodies & Cavities
- TD** Technical Data

Proportional Priority Bypass Flow Control

The proportional priority bypass flow controls allow electronic control of the flow setting for the priority flow circuit. The priority flow remains constant regardless of changes in load or pressure. The excess inlet flow is diverted or bypassed to tank. The bypass port must not have any restrictions or performance will be hindered.

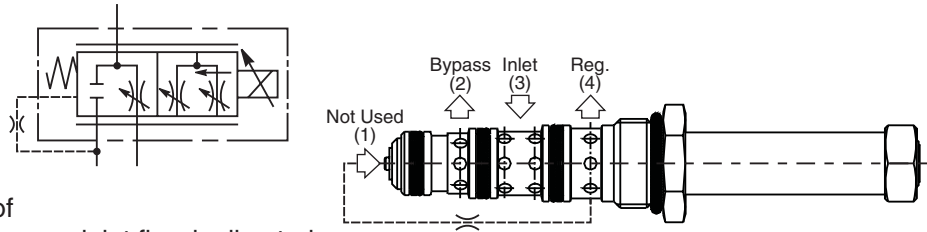

OPERATION - Flow enters the valve through port 3. With the coil de-energized, flow is bypassed to port 2. When the coil is energized, the internal orifice is increased allowing pressure compensated flow to the priority port (port 4). The excess flow is bypassed to port 2. As input current is increased, the priority flow increases and the bypass flow decreases. As the current is decreased, priority flow decreases and bypass flow is increased.

Direct Acting, Normally Closed Proportional Pressure Reducing Valve

Direct acting, normally closed proportional pressure reducing valves are used to electronically reduce the inlet pressure to one leg of a hydraulic circuit. This valve is used when a fixed regulated pressure is required regardless of the inlet pressure. This valve could be used as a clutch control for power shift transmissions and PTO, or as a pilot control for directional control valves.

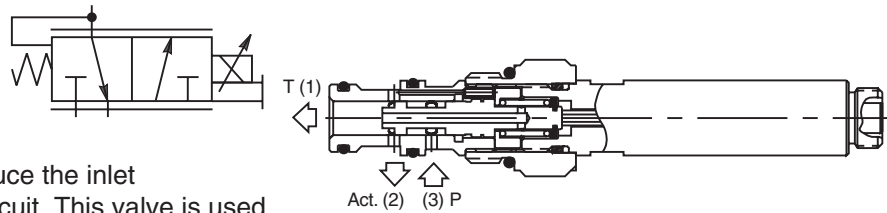

OPERATION - With the solenoid coil de-energized, the spool is held in a closed position by spring force. In this mode, the regulated pressure port is open to tank and the pressure inlet is blocked. As current is applied to the solenoid coil, the spool will begin to travel to a position where the pressure inlet port is connected to the regulated pressure port. At this point, reduced pressure becomes a function of the current signal. As long as the current signal is constant, the reduced pressure at the regulated pressure port will remain fixed regardless of any changes in inlet flow or inlet pressure. As the current signal increases or decreases, the reduced pressure at the regulated pressure port will change with respect to the changes in signal. Once the coil is fully energized, the reduced pressure of the regulated pressure port will be at the maximum reduced pressure for that valve.

Normally Closed Proportional Pressure Reducing / Relieving Valve

Normally Closed Proportional Pressure Reducing/Relieving Valves are used to electronically reduce the inlet pressure to one leg of a hydraulic circuit. In addition these valves act as a relief valve, relieving any shocks or surges that occur between its regulating port and the actuator. Parker offers direct acting and pilot operated versions of this valve. The direct acting valves are faster responding and generally have lower hysteresis, but are limited to smaller reduced pressures (generally below 800 psi depending on the valve.) Pilot operated are generally slower on response due to the two stage performance, but can have a reduced pressure as high as 3000 psi.

Direct Acting

OPERATION - With the solenoid coil de-energized, the spool is held in a closed position by spring force.

In this mode, the regulated pressure port is open to tank and the pressure inlet port is blocked. As an electronic signal is applied to the solenoid coil, the spool will begin to travel to a position where the pressure inlet port is connected to the regulated pressure port. At this point, reduced pressure becomes a function of the voltage signal. As long as the electronic signal is constant, the reduced pressure at the regulated pressure port will remain fixed regardless of any changes in inlet flow or inlet pressure. As the electronic signal increases or decreases, the reduced pressure at the regulated port will change with respect to the change in electronic signal. Once a full signal is given, the reduced pressure of the regulated pressure port will be at the maximum reduced pressure for that valve.

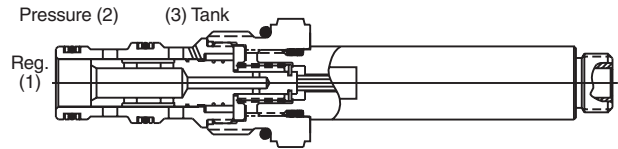
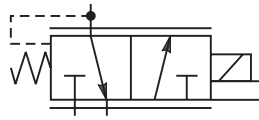

Pilot Operated

OPERATION - With the solenoid coil de-energized, the pilot dart is held open by the spring force. This allows the main spool to close and restricts flow from going from the inlet (2) port to the regulated port (1).

As the electronic signal is applied to the coil, the pilot dart is moved towards the pilot seat restricting pilot flow. This restriction raises the effective pressure inside the chamber between the spool and the pilot seat, allowing the spool to travel away from the pilot seat to a position where the pressure at inlet (2) is connected to the regulated pressure port (1). At this point, reduced pressure becomes a function of the electronic signal. As long as the electronic signal is constant, the reduced pressure at the regulated pressure port (2) will remain fixed regardless of any changes in inlet flow or inlet pressure. As the electronic signal increases or decreases, the reduced pressure at port (1) will change with respect to the change in the electronic signal.

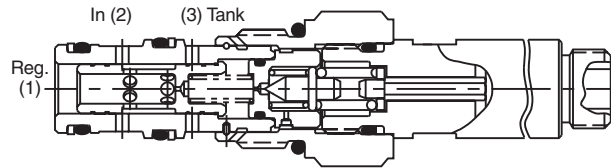
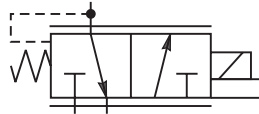

CV

Check Valves

SH

Shuttle Valves

LM

Load/Motor Controls

FC

Flow Controls

PC

Pressure Controls

LE

Logic Elements

DC

Directional Controls

MV

Manual Valves

SV

Solenoid Valves

PV

Proportional Valves

CE

Coils & Electronics

BC

Bodies & Cavities

TD

Technical Data

CV	Check Valves
SH	Shuttle Valves
LM	Load/Motor Controls
FC	Flow Controls
PC	Pressure Controls
LE	Logic Elements
DC	Directional Controls
MV	Manual Valves
SV	Solenoid Valves
PV	Proportional Valves
CE	Coils & Electronics
BC	Bodies & Cavities
TD	Technical Data

Normally Closed Proportional Relief Valve

Normally closed proportional relief valves are used to electronically control the system pressure. These valves are ideal for circuits with varying system pressures demands. A small flow pilot version of the normally closed proportional relief is also offered for piloting a larger logic element or vented relief valve. The normally closed relief defaults to a maximum pressure setting (i.e. 3000 psi) when there is no current applied.

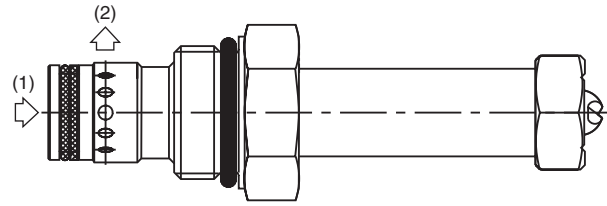
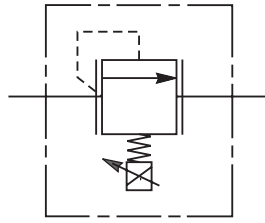

OPERATION - With the solenoid coil de-energized, the pilot dart is held closed by the spring. As current is applied to the coil, the pilot dart is moved creating less restriction of the pilot flow. As this restriction is reduced with the increasing current, the pressure setting also decreases. Once a constant electronic signal is given, the pilot dart is held in a given position, holding the pressure setting. This is maintained by the balance between the electronic spring force and the inlet pressure.

Normally Open Proportional Relief Valve

Normally open proportional relief valves are used to electronically control the system pressure. These valves are ideal for circuits with varying system pressure demands. A small flow pilot version of the normally open proportional relief is also offered for piloting a larger logic element or vented relief valve. The normally open relief defaults to minimum system pressure (i.e. 150 psi) when there is no current applied. Normally closed versions are also available upon request.

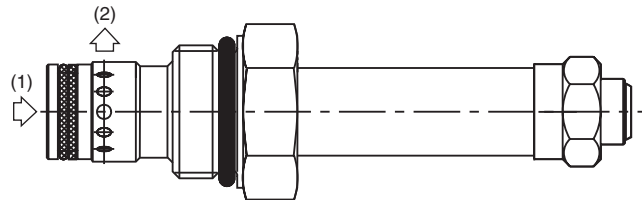
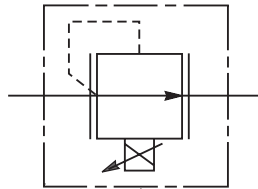

OPERATION - With the solenoid coil de-energized, the pilot dart is held open by the spring. This allows the main spool to open at minimum pressure 10.4 Bar (150 psi). As current is applied to the coil, the pilot dart is moved towards the pilot seat restricting pilot flow. This restriction raises the effective pressure setting of the valve. Once a constant electronic signal is given, the pilot dart is held in a given position, holding the pressure setting. This is maintained by a balance between electronic spring force and inlet pressure. As the electronic signal is reduced, the pilot dart is moved away from the pilot seat. This lowers the effective pressure setting of the valve.

A large grid of empty cells for taking notes.

CV

Check
Valves

SH

Shuttle
Valves

LM

Load/Motor
Controls

FC

Flow
Controls

PC

Pressure
Controls

LE

Logic
Elements

DC

Directional
Controls

MV

Manual
Valves

SV

Solenoid
Valves

PV

Proportional
Valves

CE

Coils &
Electronics

BC

Bodies &
Cavities

TD

Technical
Data



Technical Information

- CV** Check Valves
- SH** Shuttle Valves
- LM** Load/Motor Controls
- FC** Flow Controls
- PC** Pressure Controls
- LE** Logic Elements
- DC** Directional Controls
- MV** Manual Valves
- SV** Solenoid Valves
- PV** Proportional Valves
- CE** Coils & Electronics
- BC** Bodies & Cavities
- TD** Technical Data

General Description

Proportional Relief Valve. Increasing Pressure With Increasing Current. For additional information see Technical Tips on pages PV1-PV6.

Features

- Analog Proportional Relief Valve regulates pressure proportionally to the solenoid current
- Direct acting poppet design
- One piece cartridge housing ensures internal concentricity
- Coil: Waterproof, hermetically sealed, requires no O'Rings; Symmetrical coil can be reversed without affecting performance.

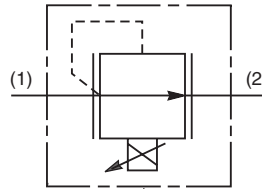
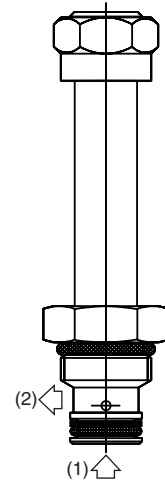

Specifications

Rated Flow (At 70 PSI ΔP)	07C 5.3 LPM (1.4 GPM) 14C 3.4 LPM (0.9 GPM) 21C 3.0 LPM (0.8 GPM) 35C 1.3 LPM (.35 GPM)
Max. Pressure At Port 1 @ 75% Input Current	07C 70 Bar (1000 PSI) 14C 140 Bar (2000 PSI) 21C 210 Bar (3000 PSI) 35C 350 Bar (5000 PSI)
Hysteresis @ 200 Hz PWM	5%
Cracking Pressure	07C .07 Bar (1 PSI) 14C .14 Bar (2 PSI) 21C .21 Bar (3 PSI) 35C .35 Bar (4 PSI)
Cartridge Material	All parts steel. All operating parts hardened steel.
Operating Temp. Range/Seals	-40°C to +93.3°C (Nitrile) (-40°F to +200°F) -31.7°C to +121.1°C (Fluorocarbon) (-25°F to +250°F)
Fluid Compatibility/ Viscosity	Mineral-based or synthetic with lubricating properties at viscosities of 45 to 2000 SSU (6 to 420 cSt)
Filtration	ISO Code 16/13, SAE Class 4 or better
Approx. Weight	.06 kg (.14 lbs.)
Cavity	2G (See BC Section for more details)

Performance Curves

▲ PWM Current Regulator Recommended

Pressure Drop vs. Flow

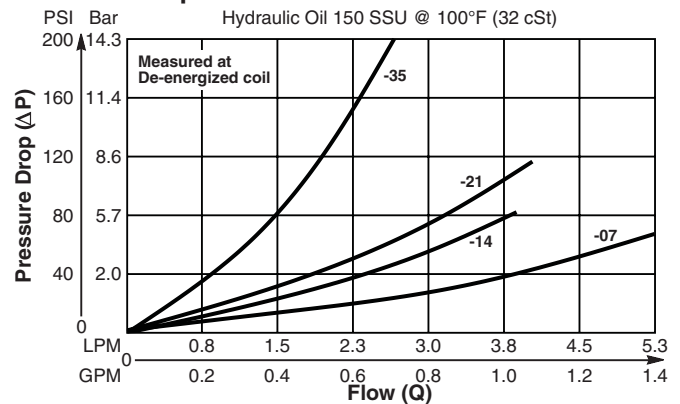

Pressure vs. Input Signal (Current)

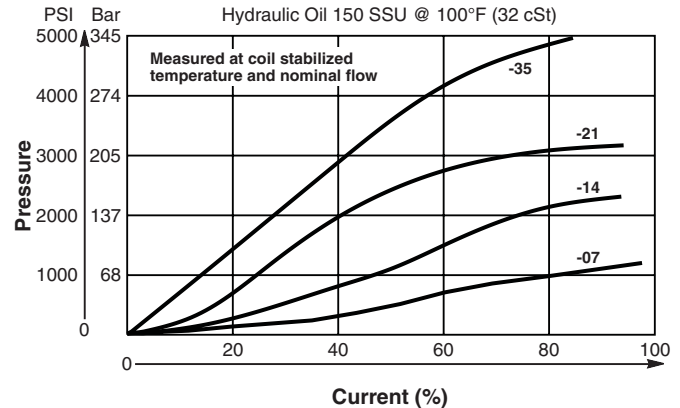

Dimensions Millimeters (Inches)

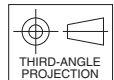
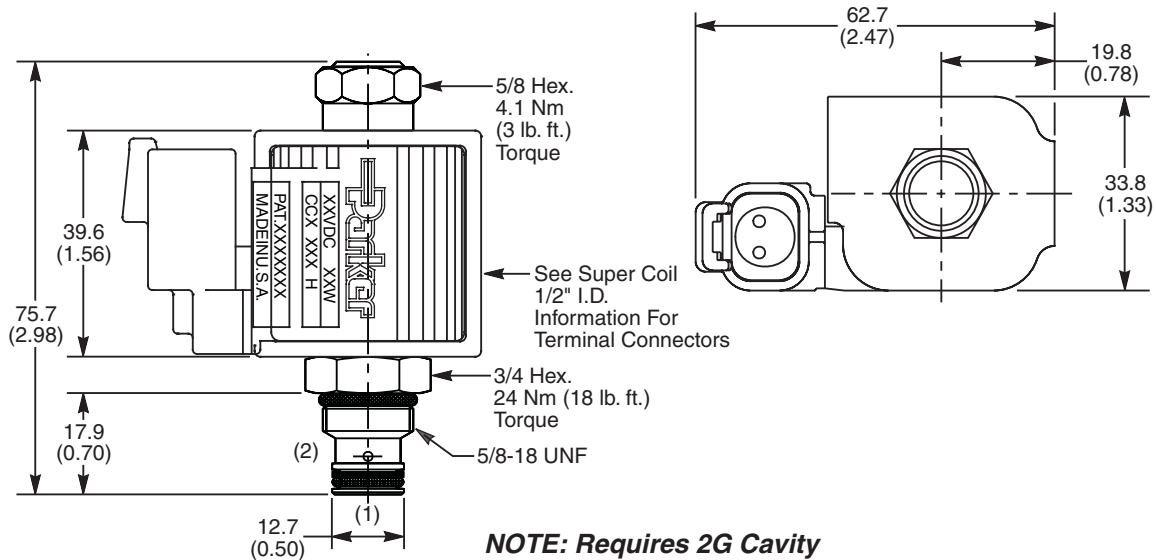

Ordering Information

AP01B2YP

08 Size Proportional Relief Valve Style Seals Coil Type Coil Voltage Coil Termination

Code	Style (Maximum Relief Pressure)
07C	70 Bar (1000 PSI)
14C	140 Bar (2000 PSI)
21C	210 Bar (3000 PSI)
35C	350 Bar (5000 PSI)

Custom pressure setting available. Consult factory.

Code	Seals / Kit No.
N	Nitrile / Buna-N (Std.) (SK30129N-1)
V	Fluorocarbon / (SK30129V-1)
E	Ethylene Propylene

Code	Coil Type
Omit	Without Coil
SP	Super Coil - 19 Watts

Code	Coil Voltage
Omit	Without Coil
D012	12 VDC
D024	24 VDC

Code	Coil Termination
Omit	Without Coil
D	DIN Plug Face
A	Amp Jr. Timer*
L	Dual Lead Wire*
LS	Sealed Lead Wire*
H	Molded Deutsch*

See Super Coil 1/2" I.D.
 *DC Only

Order Bodies Separately

LB10

Line Body Porting Body Material

Code	Porting
324	1/4" SAE
325	1/4" BSP

Code	Body Material
A	Aluminum
S	Steel



- CV** Check Valves
- SH** Shuttle Valves
- LM** Load/Motor Controls
- FC** Flow Controls
- PC** Pressure Controls
- LE** Logic Elements
- DC** Directional Controls
- MV** Manual Valves
- SV** Solenoid Valves
- PV** Proportional Valves
- CE** Coils & Electronics
- BC** Bodies & Cavities
- TD** Technical Data

Technical Information

- CV** Check Valves
- SH** Shuttle Valves
- LM** Load/Motor Controls
- FC** Flow Controls
- PC** Pressure Controls
- LE** Logic Elements
- DC** Directional Controls
- MV** Manual Valves
- SV** Solenoid Valves
- PV** Proportional Valves
- CE** Coils & Electronics
- BC** Bodies & Cavities
- TD** Technical Data

General Description

Proportional Relief Valve. Increasing Pressure With Increasing Current. For additional information see Technical Tips on pages PV1-PV6.

Features

- Analog Proportional Relief Valve regulates pressure proportionally to the solenoid current
- Direct acting poppet design
- One piece cartridge housing ensures internal concentricity
- Coil: Waterproof, hermetically sealed, requires no O'Rings; Symmetrical coil can be reversed without affecting performance.

NOTE:

This valve will be available January 1, 2011.

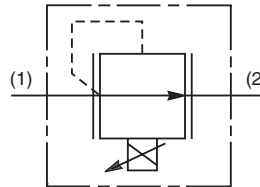
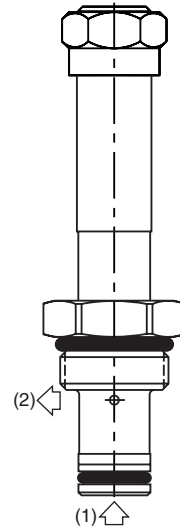

Specifications

Rated Flow (At 70 PSI ΔP)	07C 5.3 LPM (1.4 GPM) 14C 3.4 LPM (0.9 GPM) 21C 3.0 LPM (0.8 GPM) 35C 1.3 LPM (.35 GPM)
Max. Pressure At Port 1 @ 75% Input Current	07C 70 Bar (1000 PSI) 14C 140 Bar (2000 PSI) 21C 210 Bar (3000 PSI) 35C 350 Bar (5000 PSI)
Hysteresis @ 200 Hz PWM	5%
Cracking Pressure	07C .07 Bar (1 PSI) 14C .14 Bar (2 PSI) 21C .21 Bar (3 PSI) 35C .35 Bar (4 PSI)
Cartridge Material	All parts steel. All operating parts hardened steel.
Operating Temp. Range/Seals	-40°C to +93.3°C (Nitrile) (-40°F to +200°F) -31.7°C to +121.1°C (Fluorocarbon) (-25°F to +250°F)
Fluid Compatibility/ Viscosity	Mineral-based or synthetic with lubricating properties at viscosities of 45 to 2000 SSU (6 to 420 cSt)
Filtration	ISO Code 16/13, SAE Class 4 or better
Approx. Weight	.06 kg (.14 lbs.)
Cavity	C08-2 (See BC Section for more details)

Performance Curves

▲ PWM Current Regulator Recommended

Pressure Drop vs. Flow

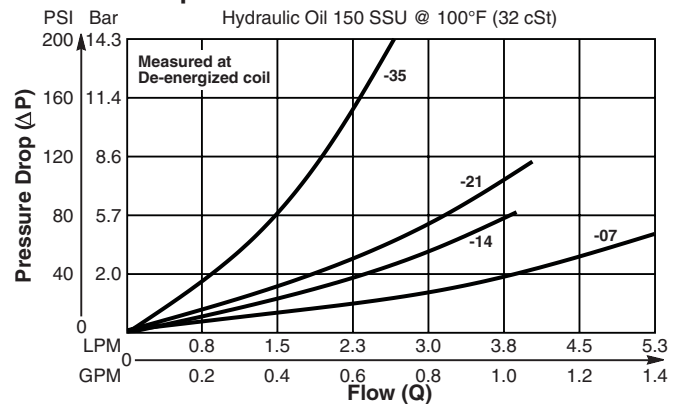

Pressure vs. Input Signal (Current)

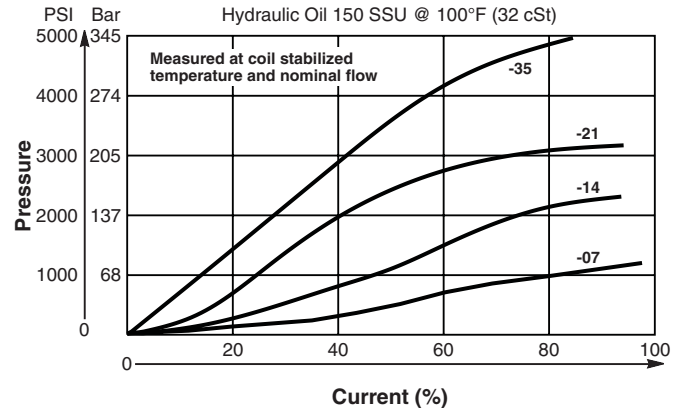

Dimensions Millimeters (Inches)

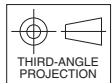
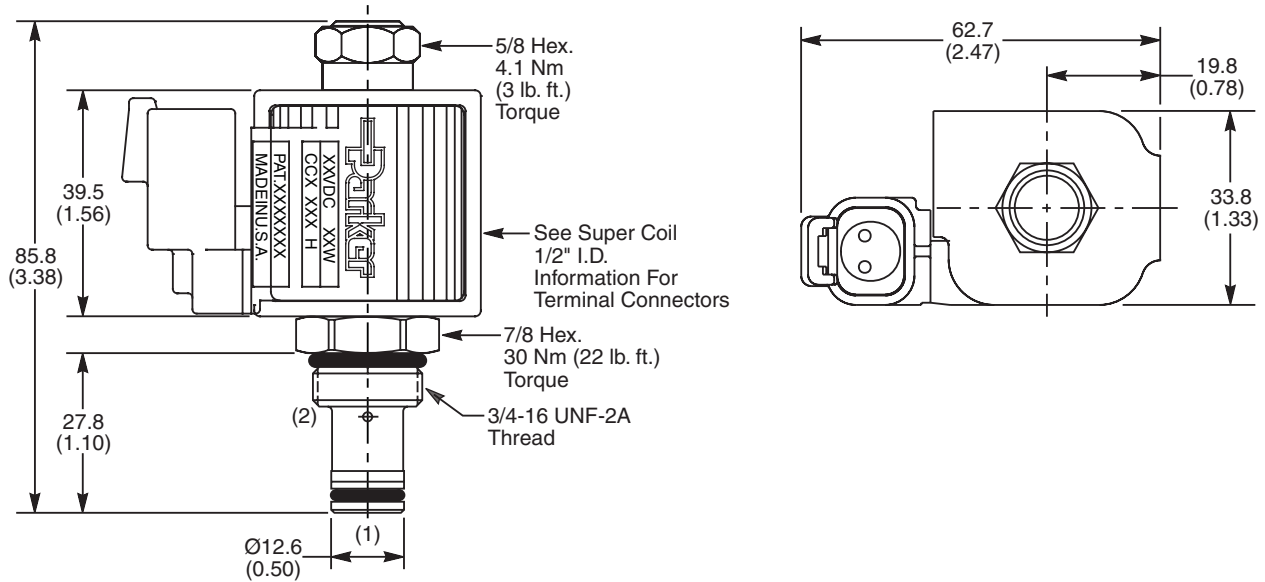

Ordering Information

AP02B2YP

08 Size Proportional Relief Valve Style Seals Coil Type Coil Voltage Coil Termination Body Material Port Size

NOTE:
This valve will be available January 1, 2011.

Code	Style (Maximum Relief Pressure)
07C	70 Bar (1000 PSI)
14C	140 Bar (2000 PSI)
21C	210 Bar (3000 PSI)
35C	350 Bar (5000 PSI)

Custom pressure setting available. Consult factory.

Code	Seals / Kit No.
Omit	"D"-Ring / (SK08-2)
N	Nitrile / Buna-N (Std.) (SK08-2N)
V	Fluorocarbon / (SK08-2V)

Code	Coil Type
Omit	Without Coil
SP	Super Coil - 19 Watts

Code	Coil Voltage
Omit	Without Coil
D012	12 VDC
D024	24 VDC

Code	Coil Termination
Omit	Without Coil
D	DIN Plug Face
A	Amp Jr. Timer*
L	Dual Lead Wire*
LS	Sealed Lead Wire*
H	Molded Deutsch*

*See Super Coil 1/2" I.D. *DC Only*

Code	Body Material
Omit	Steel
A	Aluminum

Code	Port Size	Body Part No.
Omit	Cartridge Only	
4T	SAE-4	(B08-2-*4T)
6T	SAE-6	(B08-2-*6T)
6B	3/8" BSPG	(B08-2-*6B)

** Add "A" for aluminum, omit for steel.*

- CV
Check Valves
- SH
Shuttle Valves
- LM
Load/Motor Controls
- FC
Flow Controls
- PC
Pressure Controls
- LE
Logic Elements
- DC
Directional Controls
- MV
Manual Valves
- SV
Solenoid Valves
- PV
Proportional Valves
- CE
Coils & Electronics
- BC
Bodies & Cavities
- TD
Technical Data

Technical Information

- CV** Check Valves
- SH** Shuttle Valves
- LM** Load/Motor Controls
- FC** Flow Controls
- PC** Pressure Controls
- LE** Logic Elements
- DC** Directional Controls
- MV** Manual Valves
- SV** Solenoid Valves
- PV** Proportional Valves
- CE** Coils & Electronics
- BC** Bodies & Cavities
- TD** Technical Data

General Description

Proportional Relief Valve. Increasing Pressure With Increasing Current. For additional information see Technical Tips on pages PV1-PV6.

Features

- Pilot operated spool-type design fits industry common cavity (10-2)
- Relieving pressure output is proportional to DC current input
- Precise setting of factory preset pressure in energized mode
- One piece cartridge housing ensures internal concentricity
- Coil: Waterproof, hermetically sealed, requires no O’Rings; Symmetrical coil can be reversed without affecting performance.

Specifications

Rated Flow (At 300 PSI ΔP) When Coil is Fully De-Energized	95 LPM (25 GPM)	
Factory Set Relief Pressure When Coil De-Energized Measured at 45 LPM (12 GPM)	10C	103 Bar (1500 PSI)
	21C	210 Bar (3000 PSI)
	35C	350 Bar (5000 PSI)
Hysteresis @ 250 Hz PWM	< 7% of Maximum Pressure Setting	
Response Time At 75% of Nominal Voltage Change (Measured To 90% of Press. Change)	To Unload	10ms
	To Load	
	10C	45 ms
	21C	60 ms
	35C	80 ms
Cartridge Material	All parts steel. All operating parts hardened steel.	
Operating Temp. Range/Seals	-40°C to +93.3°C (Nitrile) (-40°F to +200°F) -31.7°C to +121.1°C (Fluorocarbon) (-25°F to +250°F)	
Fluid Compatibility/ Viscosity	Mineral-based or synthetic with lubricating properties at viscosities of 45 to 2000 SSU (6 to 420 cSt)	
Filtration	ISO Code 16/13, SAE Class 4 or better	
Approx. Weight	.14 kg (.31 lbs.)	
Cavity	C10-2 (See BC Section for more details)	

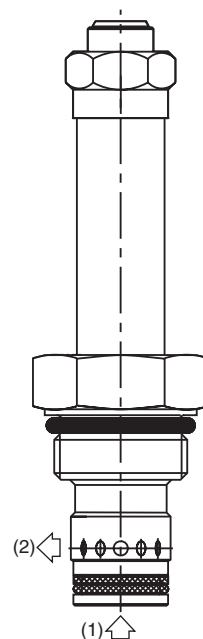
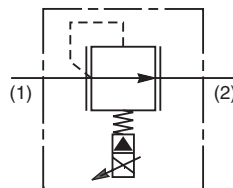

Performance Curves

▲ PWM Current Regulator Recommended
Relief Performance

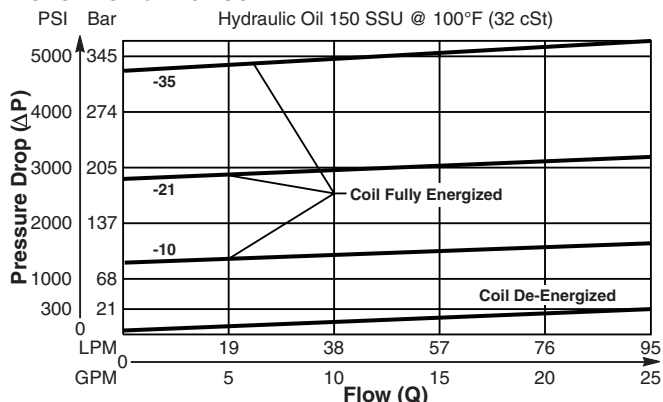

Pressure vs. Input Current

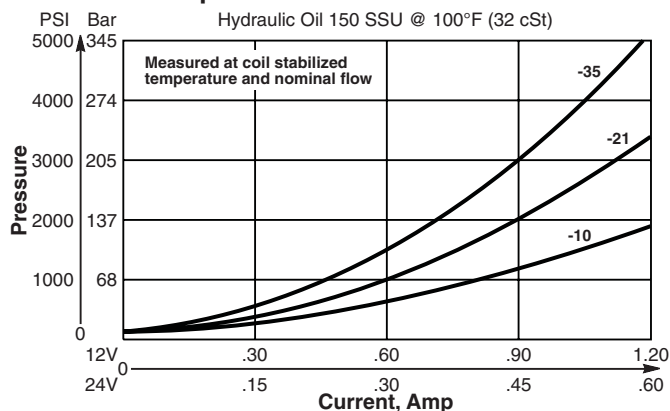

Dimensions Millimeters (Inches)

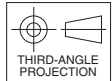
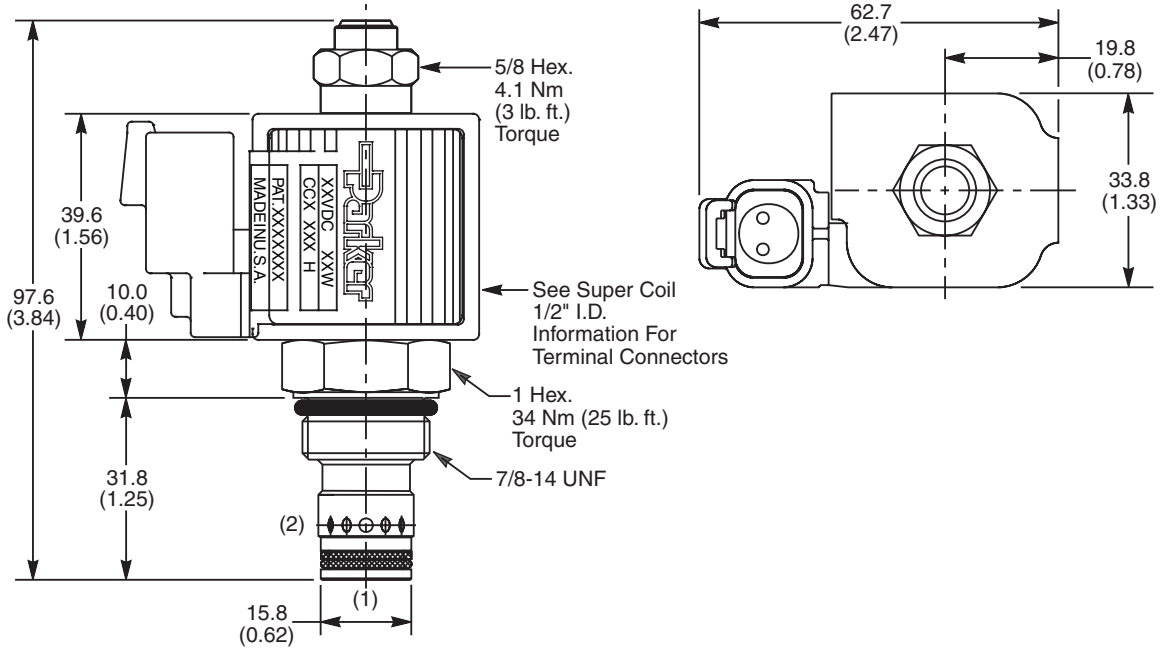

Ordering Information

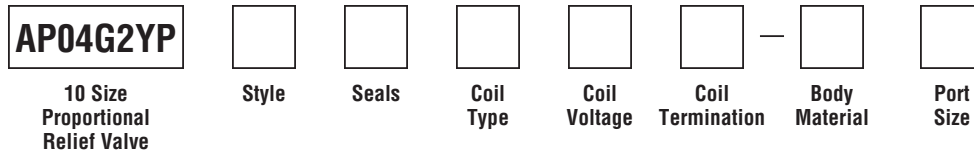

Code	Style (Maximum Relief Pressure)
10C	104 Bar (1500 PSI)
21C	210 Bar (3000 PSI)
35C	350 Bar (5000 PSI)

Custom pressure setting available. Consult factory.

Code	Seals / Kit. No.
N	Nitrile / Buna-N (Std.) (SK30503N-1)
V	Fluorocarbon / (SK30503V-1)

Code	Coil Type
Omit	Without Coil
SP	Super Coil - 19 Watts

Code	Coil Voltage
Omit	Without Coil
D012	12 VDC
D024	24 VDC

Code	Coil Termination
Omit	Without Coil
D	DIN Plug Face
A	Amp Jr. Timer*
L	Dual Lead Wire*
LS	Sealed Lead Wire*
H	Molded Deutsch*

See Super Coil 1/2" I.D.
 *DC Only

Code	Body Material
Omit	Steel
A	Aluminum

Code	Port Size	Body Part No.
Omit	Cartridge Only	
4P	1/4" NPTF	(B10-2-*4P)
6P	3/8" NPTF	(B10-2-*6P)
8P	1/2" NPTF	(B10-2-*8P)
6T	SAE-6	(B10-2-*6T)
8T	SAE-8	(B10-2-*8T)
T8T	SAE-8	(B10-2-T8T)†
6B	3/8" BSPG	(B10-2-*6B)

* Add "A" for aluminum, omit for steel.
 † Steel body only.

- CV
- Check Valves
- SH
- Shuttle Valves
- LM
- Load/Motor Controls
- FC
- Flow Controls
- PC
- Pressure Controls
- LE
- Logic Elements
- DC
- Directional Controls
- MV
- Manual Valves
- SV
- Solenoid Valves
- PV
- Proportional Valves
- CE
- Coils & Electronics
- BC
- Bodies & Cavities
- TD
- Technical Data

Technical Information

- CV** Check Valves
- SH** Shuttle Valves
- LM** Load/Motor Controls
- FC** Flow Controls
- PC** Pressure Controls
- LE** Logic Elements
- DC** Directional Controls
- MV** Manual Valves
- SV** Solenoid Valves
- PV** Proportional Valves
- CE** Coils & Electronics
- BC** Bodies & Cavities
- TD** Technical Data

General Description

Proportional Relief Valve. Decreasing Pressure With Increasing Current. For additional information see Technical Tips on pages PV1-PV6.

Features

- Analog Proportional Relief Valve regulates pressure proportionally to the input solenoid current
- Direct acting poppet design
- One piece cartridge housing ensures internal concentricity
- Coil: Waterproof, hermetically sealed, requires no O’Rings; Symmetrical coil can be reversed without affecting performance.

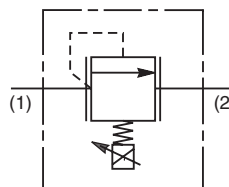
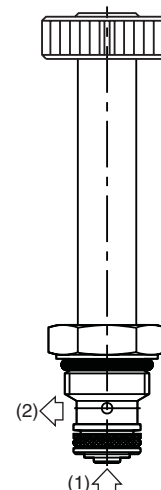

Specifications

Rated Flow (At 70 PSI ΔP)	07A 5.3 LPM (1.4 GPM) 14A 3.4 LPM (0.9 GPM) 21A 3.0 LPM (0.8 GPM) 35A 1.9 LPM (0.5 GPM)
Factory Set Relief Pressure When De-Energized (±5% -Std. ±2% - Low Variation)	07A 70 Bar (1000 PSI) 14A 140 Bar (2000 PSI) 21A 210 Bar (3000 PSI) 35A 350 Bar (5000 PSI)
Hysteresis @ 200 Hz PWM	< 10%
Cartridge Material	All parts steel. All operating parts hardened steel.
Operating Temp. Range/Seals	-40°C to +93.3°C (Nitrile) (-40°F to +200°F) -31.7°C to +121.1°C (Fluorocarbon) (-25°F to +250°F)
Fluid Compatibility/ Viscosity	Mineral-based or synthetic with lubricating properties at viscosities of 45 to 2000 SSU (6 to 420 cSt)
Filtration	ISO Code 16/13, SAE Class 4 or better
Approx. Weight	.09 kg (.19 lbs.)
Cavity	2G (See BC Section for more details)

Performance Curves

▲ PWM Current Regulator Recommended
Relief Performance

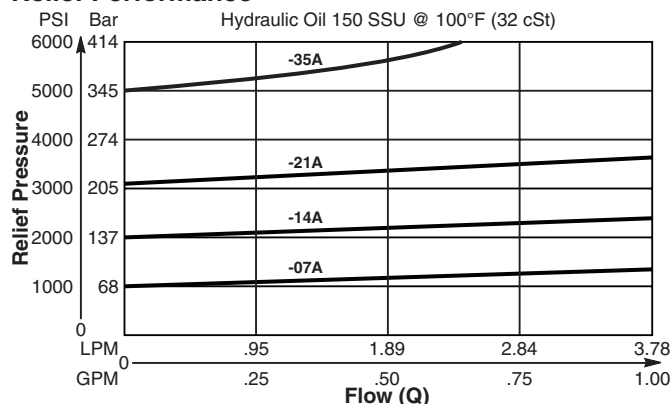

Pressure vs. Input Current

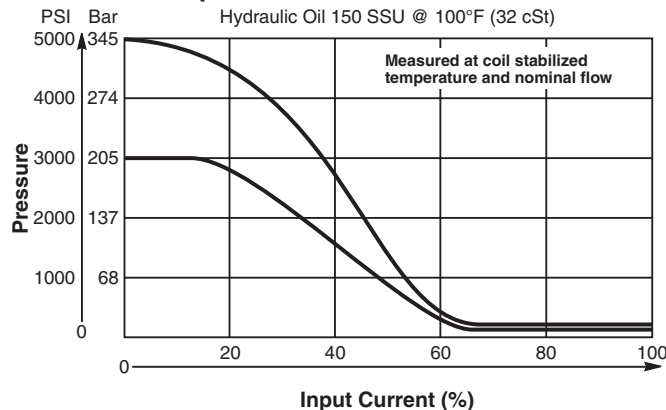

Dimensions Millimeters (Inches)

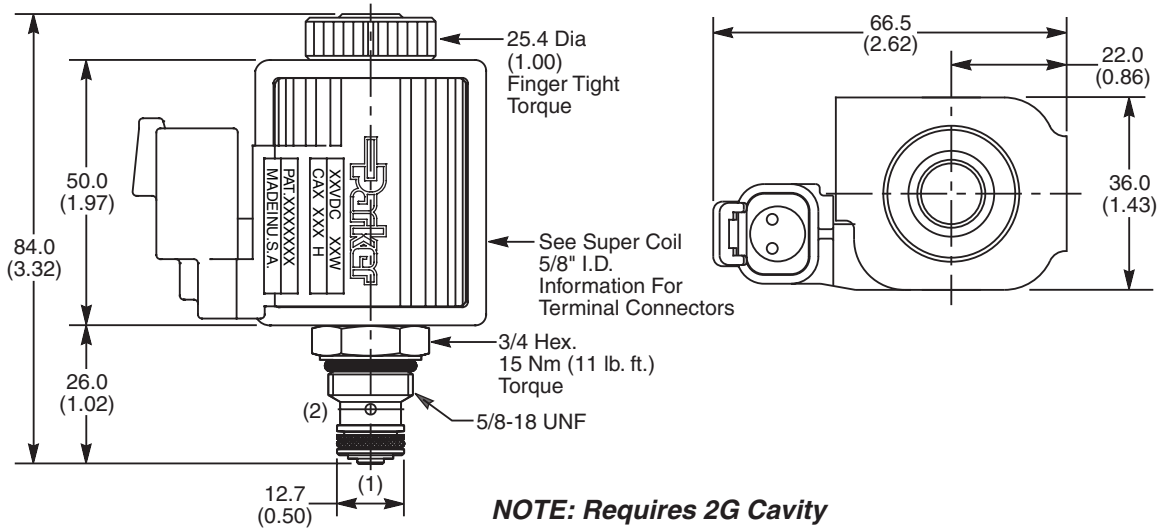

NOTE: Requires 2G Cavity

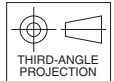

Ordering Information

AP01B2YR

08 Size Proportional Relief Valve Style Seals Coil Type Coil Voltage Coil Termination

Code	Style (Maximum Relief Pressure)
07AL	70 Bar (1000 PSI)
14AL	140 Bar (2000 PSI)
21AL	210 Bar (3000 PSI)
35AL	350 Bar (5000 PSI)

Custom pressure setting available. Consult factory.

Code	Seals / Kit. No.
N	Nitrile / Buna-N (Std.) (SK30129N-1)
V	Fluorocarbon / (SK30129V-1)
E	Ethylene Propylene

Code	Coil Type
Omit	Without Coil
SP	Super Coil - 28 Watts

Code	Coil Voltage
Omit	Without Coil
D012	12 VDC
D024	24 VDC

Code	Coil Termination
Omit	Without Coil
D	DIN Plug Face
A	Amp Jr. Timer*
L	Dual Lead Wire*
LS	Sealed Lead Wire*
H	Molded Deutsch*

See Super Coil 5/8" I.D.
 *DC Only

Order Bodies Separately

LB10

Line Body Porting Body Material

Code	Porting
324	1/4" SAE
325	1/4" BSP

Code	Body Material
A	Aluminum
S	Steel



- CV**
Check Valves
- SH**
Shuttle Valves
- LM**
Load/Motor Controls
- FC**
Flow Controls
- PC**
Pressure Controls
- LE**
Logic Elements
- DC**
Directional Controls
- MV**
Manual Valves
- SV**
Solenoid Valves
- PV**
Proportional Valves
- CE**
Coils & Electronics
- BC**
Bodies & Cavities
- TD**
Technical Data

Technical Information

- CV** Check Valves
- SH** Shuttle Valves
- LM** Load/Motor Controls
- FC** Flow Controls
- PC** Pressure Controls
- LE** Logic Elements
- DC** Directional Controls
- MV** Manual Valves
- SV** Solenoid Valves
- PV** Proportional Valves
- CE** Coils & Electronics
- BC** Bodies & Cavities
- TD** Technical Data

General Description

Proportional Relief Valve. Decreasing Pressure With Increasing Current. For additional information see Technical Tips on pages PV1-PV6.

Features

- Analog Proportional Relief Valve regulates pressure proportionally to the input solenoid current
- Direct acting poppet design
- One piece cartridge housing ensures internal concentricity
- Coil: Waterproof, hermetically sealed, requires no O’Rings; Symmetrical coil can be reversed without affecting performance.

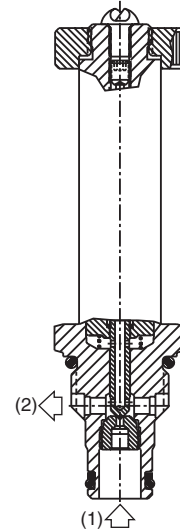
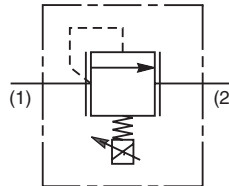

Specifications

Rated Flow (At 70 PSI ΔP)	07A 5.3 LPM (1.4 GPM) 14A 3.4 LPM (0.9 GPM) 21A 3.0 LPM (0.8 GPM) 35A 1.9 LPM (0.5 GPM)
Factory Set Relief Pressure When De-Energized (±5% -Std. ±2% - Low Variation)	07A 70 Bar (1000 PSI) 14A 140 Bar (2000 PSI) 21A 210 Bar (3000 PSI) 35A 350 Bar (5000 PSI)
Hysteresis @ 200 Hz PWM	< 10%
Cartridge Material	All parts steel. All operating parts hardened steel.
Operating Temp. Range/Seals	-40°C to +93.3°C (Nitrile) (-40°F to +200°F) -31.7°C to +121.1°C (Fluorocarbon) (-25°F to +250°F)
Fluid Compatibility/ Viscosity	Mineral-based or synthetic with lubricating properties at viscosities of 45 to 2000 SSU (6 to 420 cSt)
Filtration	ISO Code 16/13, SAE Class 4 or better
Approx. Weight	.09 kg (.19 lbs.)
Cavity	C08-2 (See BC Section for more details)

Performance Curves

▲ PWM Current Regulator Recommended

Relief Performance

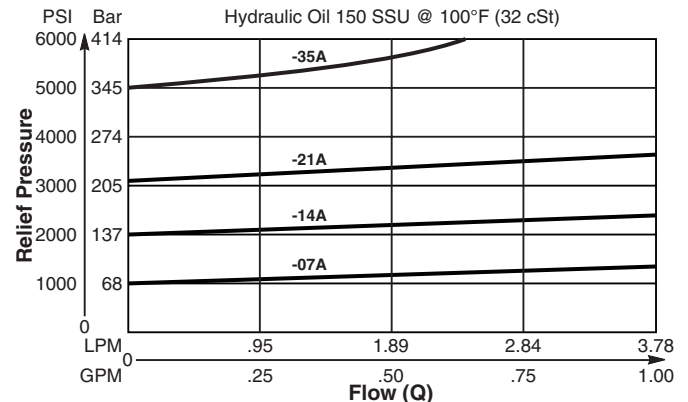

Pressure vs. Input Current

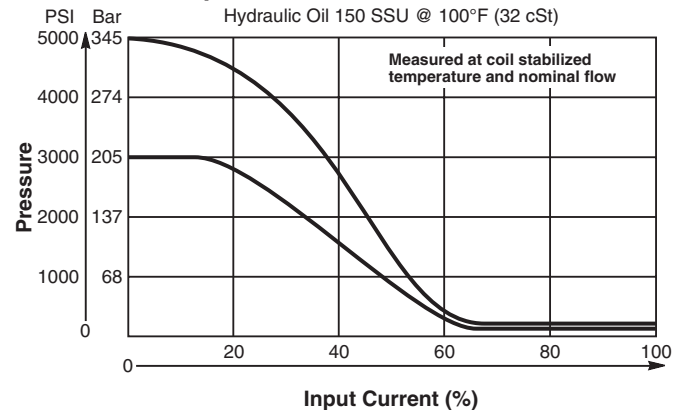

Dimensions Millimeters (Inches)

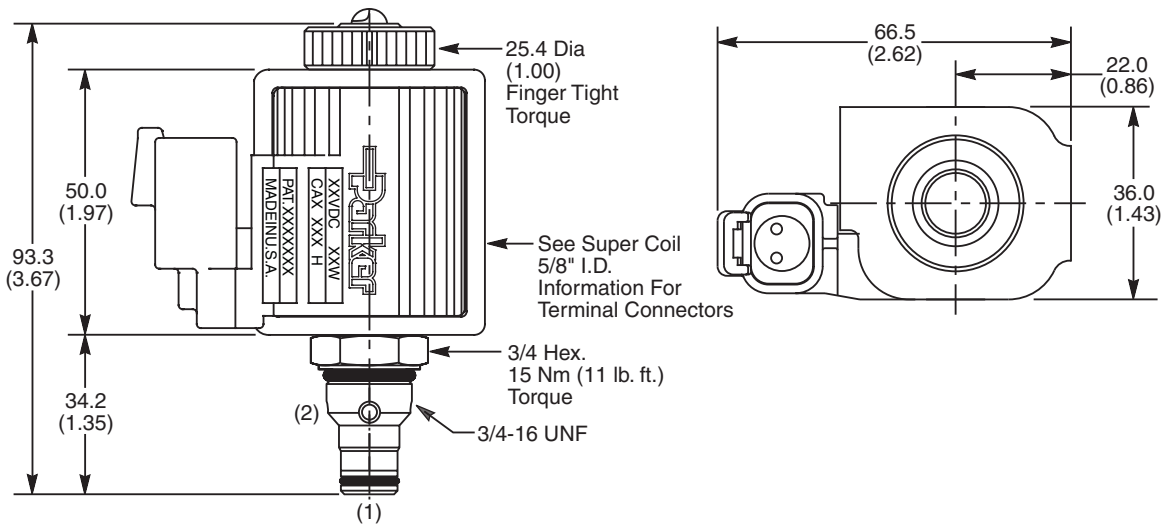

Ordering Information

AP02B2YR

08 Size Proportional Relief Valve **Style** **Seals** **Coil Type** **Coil Voltage** **Coil Termination** **Body Material** **Port Size**

Code	Style (Maximum Relief Pressure)
07AL	70 Bar (1000 PSI)
14AL	140 Bar (2000 PSI)
21AL	210 Bar (3000 PSI)
35AL	350 Bar (5000 PSI)

Custom pressure setting available. Consult factory.

Code	Seals / Kit. No.
N	Nitrile / Buna-N (Std.) (SK30006N-1)
V	Fluorocarbon / (SK30006V-1)
E	Ethylene Propylene

Code	Coil Type
Omit	Without Coil
SP	Super Coil - 28 Watts

Code	Coil Voltage
Omit	Without Coil
D012	12 VDC
D024	24 VDC

Code	Coil Termination
Omit	Without Coil
D	DIN Plug Face
A	Amp Jr. Timer*
L	Dual Lead Wire*
LS	Sealed Lead Wire*
H	Molded Deutsch*

See Super Coil 5/8" I.D.
 *DC Only

Code	Body Material
Omit	Steel
A	Aluminum

Code	Port Size	Body Part No.
Omit	Cartridge Only	
4P	1/4" NPTF	(B08-2-*4P)
6P	3/8" NPTF	(B08-2-*6P)
4T	SAE-4	(B08-2-*4T)
6T	SAE-6	(B08-2-*6T)
6B	3/8" BSPG	(B08-2-*6B)

* Add "A" for aluminum, omit for steel.

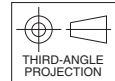

- CV**
Check Valves
- SH**
Shuttle Valves
- LM**
Load/Motor Controls
- FC**
Flow Controls
- PC**
Pressure Controls
- LE**
Logic Elements
- DC**
Directional Controls
- MV**
Manual Valves
- SV**
Solenoid Valves
- PV**
Proportional Valves
- CE**
Coils & Electronics
- BC**
Bodies & Cavities
- TD**
Technical Data

Technical Information

- CV** Check Valves
- SH** Shuttle Valves
- LM** Load/Motor Controls
- FC** Flow Controls
- PC** Pressure Controls
- LE** Logic Elements
- DC** Directional Controls
- MV** Manual Valves
- SV** Solenoid Valves
- PV** Proportional Valves
- CE** Coils & Electronics
- BC** Bodies & Cavities
- TD** Technical Data

General Description

Proportional Relief Valve. Decreasing Pressure With Increasing Current. For additional information see Technical Tips on pages PV1-PV6.

Features

- Pilot operated spool-type design
- Precise setting of factory preset pressure in de-energized mode
- One piece cartridge housing ensures internal concentricity
- Coil: Waterproof, hermetically sealed, requires no O'Rings; Symmetrical coil can be reversed without affecting performance.

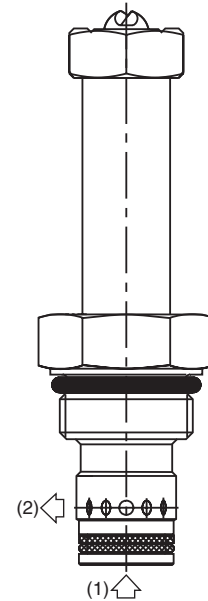
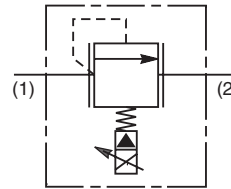

Specifications

Rated Flow (At 300 PSI ΔP) When Coil is Fully Energized	95 LPM (25 GPM)	
Factory Set Relief Pressure When Coil De-Energized Measured at 45 LPM (12 GPM)	10C	103 Bar (1500 PSI)
	21C	210 Bar (3000 PSI)
	35C	350 Bar (5000 PSI)
Hysteresis @ 250 Hz PWM	< 7% of Maximum Pressure Setting	
Response Time At 75% of Nominal Voltage Change (Measured To 90% of Press. Change)	To Unload	45ms
	To Load	25ms
Cartridge Material	All parts steel. All operating parts hardened steel.	
Operating Temp. Range/Seals	-40°C to +93.3°C (Nitrile) (-40°F to +200°F) -31.7°C to +121.1°C (Fluorocarbon) (-25°F to +250°F)	
Fluid Compatibility/ Viscosity	Mineral-based or synthetic with lubricating properties at viscosities of 45 to 2000 SSU (6 to 420 cSt)	
Filtration	ISO Code 16/13, SAE Class 4 or better	
Approx. Weight	.14 kg (.30 lbs.)	
Cavity	C10-2 (See BC Section for more details)	

Performance Curves

▲ PWM Current Regulator Recommended

Relief Performance

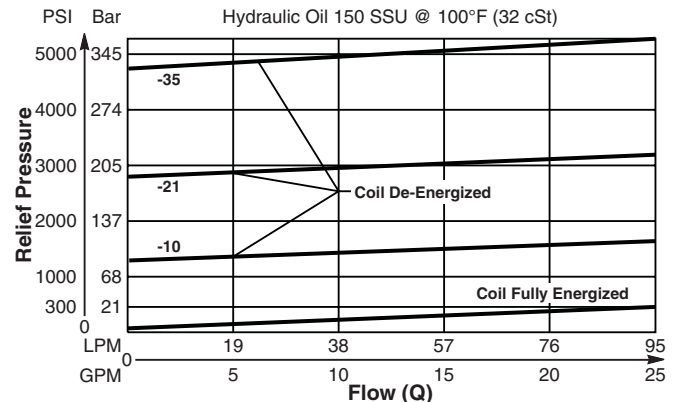

Pressure vs. Input Current

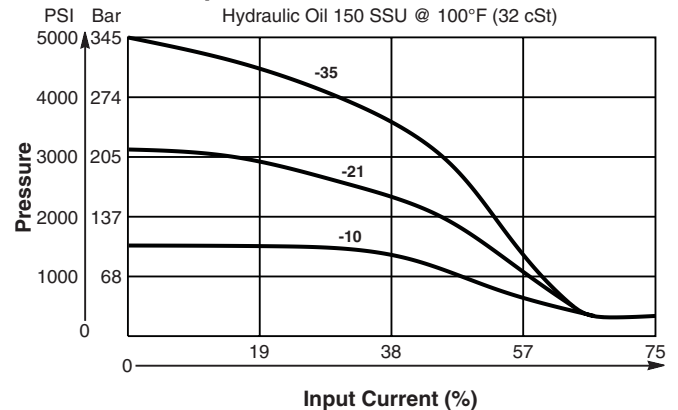

Dimensions Millimeters (Inches)

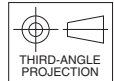
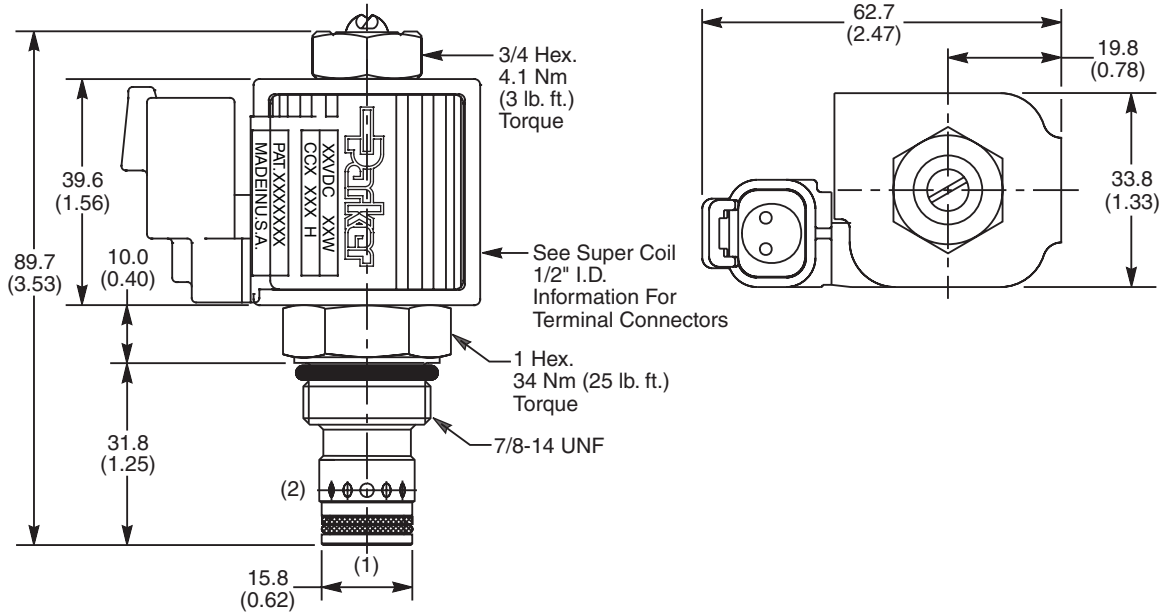

Ordering Information

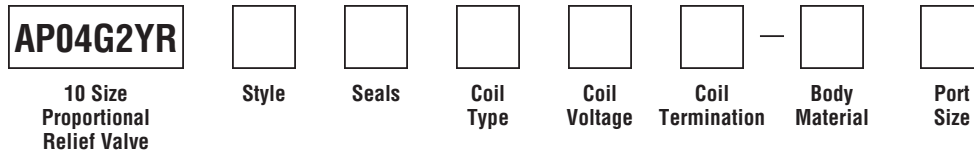

Code	Style (Maximum Relief Pressure)
10C	104 Bar (1500 PSI)
21C	210 Bar (3000 PSI)
35C	350 Bar (5000 PSI)

Custom pressure setting available. Consult factory.

Code	Seals / Kit. No.
N	Nitrile / Buna-N (Std.) (SK30503N-1)
V	Fluorocarbon / (SK30503V-1)

Code	Coil Type
Omit	Without Coil
SP	Super Coil - 19 Watts

Code	Coil Voltage
Omit	Without Coil
D012	12 VDC
D024	24 VDC

Code	Coil Termination
Omit	Without Coil
D	DIN Plug Face
A	Amp Jr. Timer*
L	Dual Lead Wire*
LS	Sealed Lead Wire*
H	Molded Deutsch*

See Super Coil 1/2" I.D.
 *DC Only

Code	Body Material
Omit	Steel
A	Aluminum

Code	Port Size	Body Part No.
Omit	Cartridge Only	
4P	1/4" NPTF	(B10-2-*4P)
6P	3/8" NPTF	(B10-2-*6P)
8P	1/2" NPTF	(B10-2-*8P)
6T	SAE-6	(B10-2-*6T)
8T	SAE-8	(B10-2-*8T)
T8T	SAE-8	(B10-2-T8T)†
6B	3/8" BSPG	(B10-2-*6B)

* Add "A" for aluminum, omit for steel.
 † Steel body only.

- CV
- Check Valves
- SH
- Shuttle Valves
- LM
- Load/Motor Controls
- FC
- Flow Controls
- PC
- Pressure Controls
- LE
- Logic Elements
- DC
- Directional Controls
- MV
- Manual Valves
- SV
- Solenoid Valves
- PV
- Proportional Valves
- CE
- Coils & Electronics
- BC
- Bodies & Cavities
- TD
- Technical Data

Technical Information

- CV** Check Valves
- SH** Shuttle Valves
- LM** Load/Motor Controls
- FC** Flow Controls
- PC** Pressure Controls
- LE** Logic Elements
- DC** Directional Controls
- MV** Manual Valves
- SV** Solenoid Valves
- PV** Proportional Valves
- CE** Coils & Electronics
- BC** Bodies & Cavities
- TD** Technical Data

General Description

3 Way, 2 Position, Proportional Pressure Reducing Valve. Bottom Cylinder Port. For additional information see Technical Tips on pages PV1-PV6.

Features

- Designed for pilot control of directional valves
- Low Hysteresis
- One piece cartridge housing ensures internal concentricity
- Coil: Waterproof, hermetically sealed, requires no O’Rings; Symmetrical coil can be reversed without affecting performance.

Specifications

Rated Flow (At 70 PSI ΔP)	1.9 LPM (0.5 GPM)
Max. Regulated Pressure @ 75% Current	Standard 17 Bar (250 PSI) High Pressure 22 Bar (320 PSI)
Max. Input Press. At Port 1	210 Bar (3000 PSI)
Max. Tank Press.	30 Bar (440 PSI)
Max. Drainage Flow In Regulating Zone	5 cc/min. When De-Energized 200 cc/min. In Regulating Zone At 68 Bar (1000 PSI) Input Pressure
Hysteresis @ 200 Hz PWM	2%
Dead End Response Time	t on = 30 ms t off = 10 ms At Step Signal 0 To 75% of Nominal Voltage
Cartridge Material	All parts steel. All operating parts hardened steel.
Operating Temp. Range/Seals	-40°C to +93.3°C (Nitrile) (-40°F to +200°F) -31.7°C to +121.1°C (Fluorocarbon) (-25°F to +250°F)
Fluid Compatibility/ Viscosity	Mineral-based or synthetic with lubricating properties at viscosities of 45 to 2000 SSU (6 to 420 cSt)
Filtration	ISO Code 16/13, SAE Class 4 or better
Approx. Weight	.08 kg (.17 lbs.)
Cavity	54-1 (See BC Section for more details)

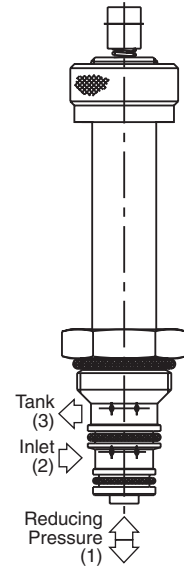
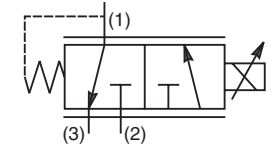

Performance Curves

▲ PWM Current Regulator Recommended

Pressure Drop vs. Flow

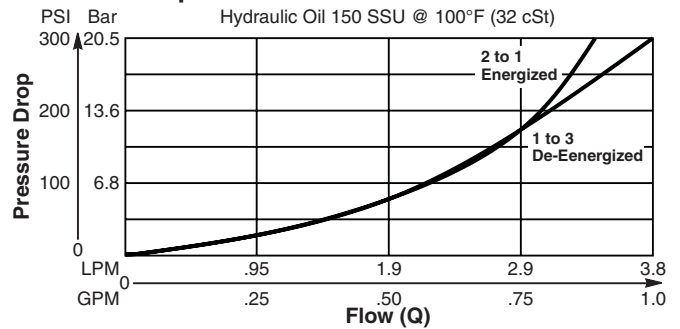

Pressure @ Port 1 vs. Input Current

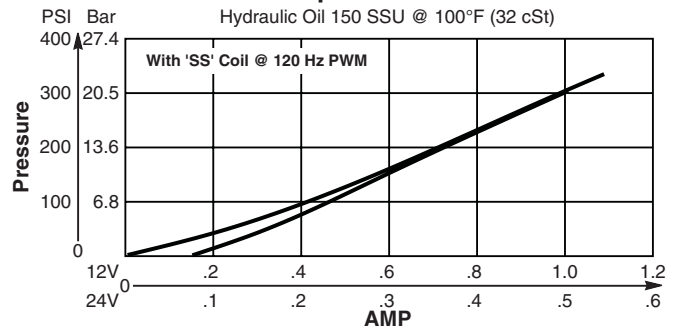

Pressure @ Port 1 vs. Input Current

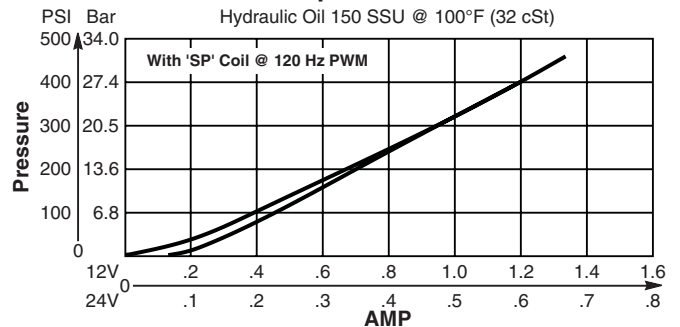

Dimensions Millimeters (Inches)

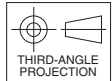
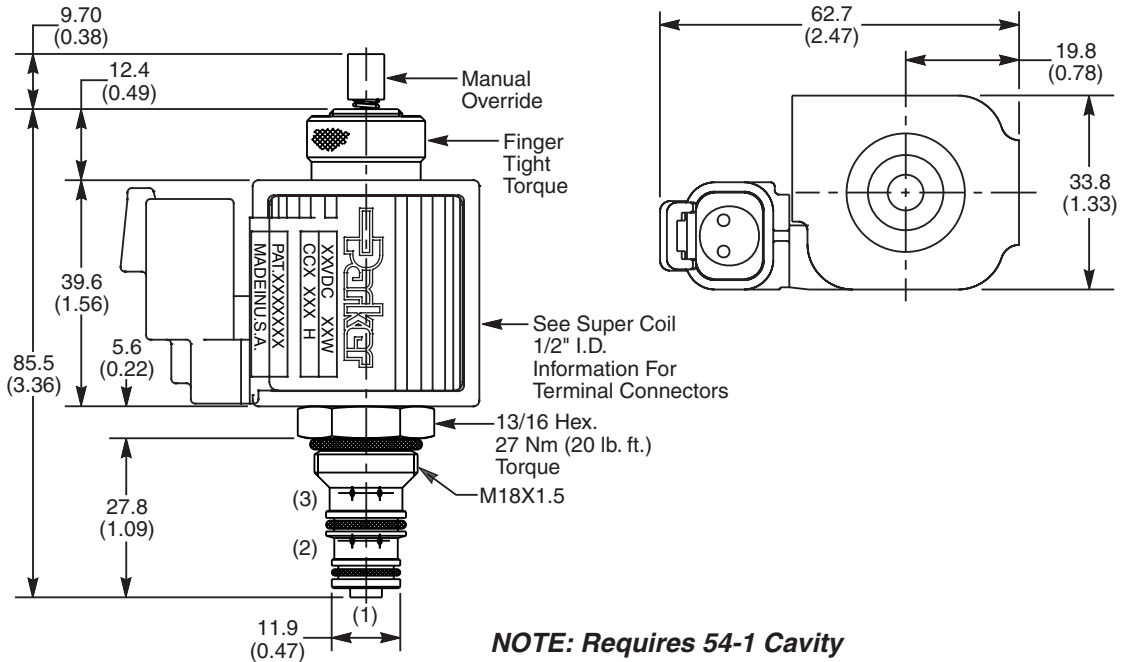

Ordering Information

GP01	30						
08 Size Proportional Valve	Style	Override Option	Filter Screen	Seals	Coil Type	Coil Voltage	Coil Termination

Code	Style
30	Standard ('SS' Coil)
30	High Pressure ('SP' Coil)

Code	Filter Screen
Omit	Not Required
F	60 Mesh Screen on Inlet Port

Code	Coil Type
Omit	Without Coil
SS	Super Coil - 14 Watts
SP	Super Coil - 19 Watts

Code	Coil Termination
Omit	Without Coil
D	DIN Plug Face
A	Amp Jr. Timer*
L	Dual Lead Wire*
LS	Sealed Lead Wire*
H	Molded Deutsch*

Code	Override Option
Omit	If No M.O.
1	Manual Override

Code	Seals / Kit No.
N	Nitrile / Buna-N (Std.) (SK30122N-1)
V	Fluorocarbon / (SK30122V-1)

Code	Coil Voltage
Omit	Without Coil
D012	12 VDC
D024	24 VDC

See Super Coil 1/2" I.D.
*DC Only

Order Bodies Separately

LB10		
Line Body	Porting	Body Material

Code	Porting
591	1/4" SAE

Code	Body Material
A	Aluminum
S	Steel



- CV**
Check Valves
- SH**
Shuttle Valves
- LM**
Load/Motor Controls
- FC**
Flow Controls
- PC**
Pressure Controls
- LE**
Logic Elements
- DC**
Directional Controls
- MV**
Manual Valves
- SV**
Solenoid Valves
- PV**
Proportional Valves
- CE**
Coils & Electronics
- BC**
Bodies & Cavities
- TD**
Technical Data

Technical Information

- CV** Check Valves
- SH** Shuttle Valves
- LM** Load/Motor Controls
- FC** Flow Controls
- PC** Pressure Controls
- LE** Logic Elements
- DC** Directional Controls
- MV** Manual Valves
- SV** Solenoid Valves
- PV** Proportional Valves
- CE** Coils & Electronics
- BC** Bodies & Cavities
- TD** Technical Data

General Description

3 Way, 2 Position, Proportional Pressure Reducing Valve. Side Cylinder Port. For additional information see Technical Tips on pages PV1-PV6.

Features

- Minimal Hysteresis
- One piece cartridge housing ensures internal concentricity
- Coil: Waterproof, hermetically sealed, requires no O’Rings; Symmetrical coil can be reversed without affecting performance.
- Nonmagnetic spool and housing assembly

Specifications

Rated Flow (At 70 PSI ΔP)	19 LPM (5 GPM)												
Max. Regulated Pressure @ 75% Current (Using ‘SP’ Coil)	<table style="border: none;"> <tr><td>02</td><td>12/17 Bar (180/240 PSI)</td></tr> <tr><td>03</td><td>19/26 Bar (270/375 PSI)</td></tr> <tr><td>05</td><td>31/40 Bar (450/580 PSI)</td></tr> <tr><td>06</td><td>41/51 Bar (600/740 PSI)</td></tr> <tr><td>09</td><td>65/79 Bar (940/1140 PSI)</td></tr> <tr><td>18</td><td>114/145 Bar (1650/2100 PSI)</td></tr> </table>	02	12/17 Bar (180/240 PSI)	03	19/26 Bar (270/375 PSI)	05	31/40 Bar (450/580 PSI)	06	41/51 Bar (600/740 PSI)	09	65/79 Bar (940/1140 PSI)	18	114/145 Bar (1650/2100 PSI)
02	12/17 Bar (180/240 PSI)												
03	19/26 Bar (270/375 PSI)												
05	31/40 Bar (450/580 PSI)												
06	41/51 Bar (600/740 PSI)												
09	65/79 Bar (940/1140 PSI)												
18	114/145 Bar (1650/2100 PSI)												
Max. Input Press. At Port 3	210 Bar (3000 PSI)												
Max. Drainage Flow In Regulating Zone	100 cc/min. When De-Energized 750 cc/min. In Regulating Zone At 21 Bar (300 PSI) Input Pressure												
Hysteresis @ 100 Hz PWM	3.5%												
Dead End Response Time	10 ms At Step Signal 0 To 75% of Nominal Voltage												
Cartridge Material	All parts steel. All operating parts hardened steel.												
Operating Temp. Range/Seals	-40°C to +93.3°C (Nitrile) (-40°F to +200°F) -31.7°C to +121.1°C (Fluorocarbon) (-25°F to +250°F)												
Fluid Compatibility/ Viscosity	Mineral-based or synthetic with lubricating properties at viscosities of 45 to 2000 SSU (6 to 420 cSt)												
Filtration	ISO Code 16/13, SAE Class 4 or better												
Approx. Weight	.08 kg (.17 lbs.)												
Cavity	C08-3 (See BC Section for more details)												

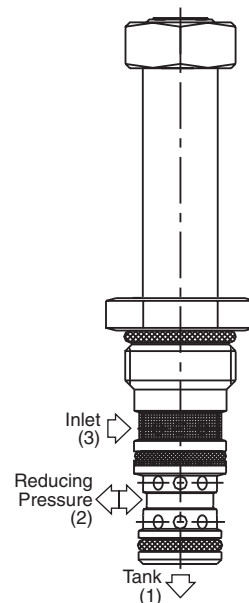
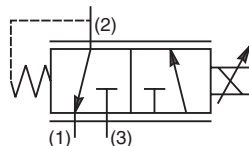

Performance Curves

▲ PWM Current Regulator Recommended

Pressure Drop vs. Flow

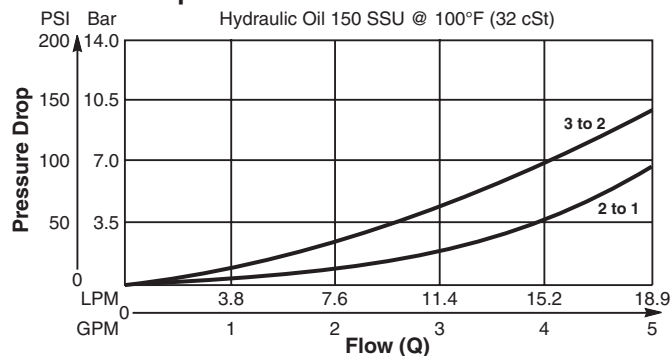

Pressure @ Port 2 vs. Input Current

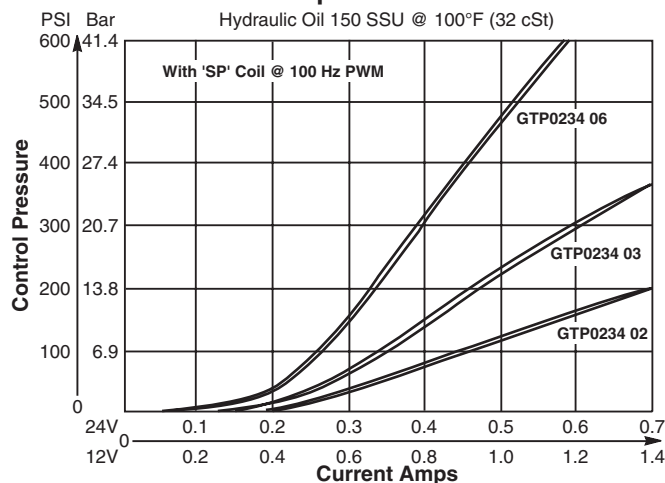

Dimensions Millimeters (Inches)

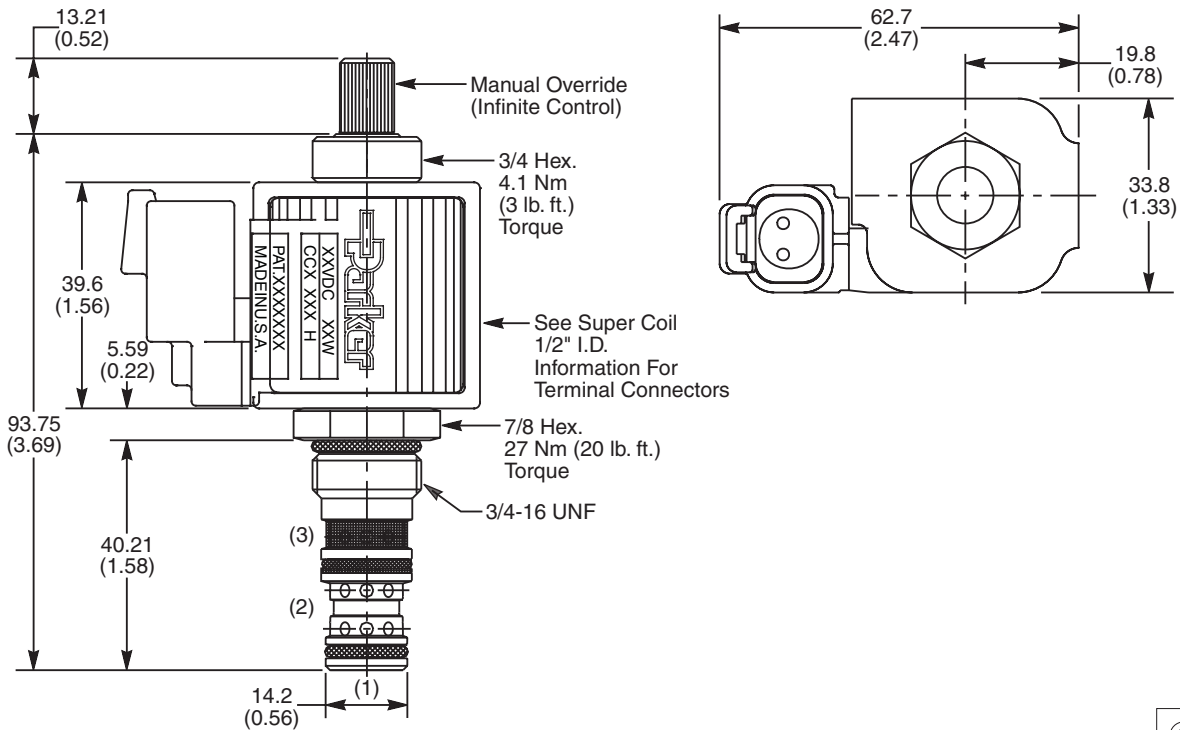

Ordering Information

08 Size Proportional Valve **Style** **Override Option** **Filter Screen** **Seals** **Coil Type** **Coil Voltage** **Coil Termination** **Body Material** **Port Size**

Code	Style (Maximum Regulated Pressure Range - SP COIL)
02	12/17 Bar (180/240 PSI)
03	19/26 Bar (270/375 PSI)
05	31/40 Bar (450/580 PSI)
06	41/51 Bar (600/740 PSI)
09	65/79 Bar (940/1140 PSI)
18	114/145 Bar (1650/2100 PSI)

Code	Filter Screen
1	60 Mesh Screen on Inlet Port

Code	Coil Voltage
Omit	Without Coil
D012	12 VDC
D024	24 VDC

Code	Body Material
Omit	Steel
A	Aluminum

Code	Override Option
0	Not Required
5	Detented M.O.

Code	Seals / Kit No.
N	Nitrile / Buna-N (Std.) (SK30081N-1)
V	Fluorocarbon / (SK30081V-1)

Code	Coil Termination
Omit	Without Coil
D	DIN Plug Face
A	Amp Jr. Timer*
L	Dual Lead Wire*
LS	Sealed Lead Wire*
H	Molded Deutsch*

Code	Port Size	Body Part No.
Omit	Cartridge Only	
4P	1/4" NPTF	(B08-3-*4P)
4T	SAE-4	(B08-3-*4T)
6T	SAE-6	(B08-3-*6T)
6B	3/8" BSPG	(B08-3-*6B)

* Add "A" for aluminum, omit for steel.

Code	Coil Type
Omit	Without Coil
SS	Super Coil - 14 Watts
SP	Super Coil - 19 Watts

See Super Coil 1/2" I.D.
 *DC Only

- CV Check Valves
- SH Shuttle Valves
- LM Load/Motor Controls
- FC Flow Controls
- PC Pressure Controls
- LE Logic Elements
- DC Directional Controls
- MV Manual Valves
- SV Solenoid Valves
- PV Proportional Valves
- CE Coils & Electronics
- BC Bodies & Cavities
- TD Technical Data

Technical Information

- CV** Check Valves
- SH** Shuttle Valves
- LM** Load/Motor Controls
- FC** Flow Controls
- PC** Pressure Controls
- LE** Logic Elements
- DC** Directional Controls
- MV** Manual Valves
- SV** Solenoid Valves
- PV** Proportional Valves
- CE** Coils & Electronics
- BC** Bodies & Cavities
- TD** Technical Data

General Description

3 Way, 2 Position, Proportional Pressure Reducing Valve. Side Cylinder Port. For additional information see Technical Tips on pages PV1-PV6.

Features

- Minimal Hysteresis
- One piece cartridge housing ensures internal concentricity
- Coil: Waterproof, hermetically sealed, requires no O’Rings; Symmetrical coil can be reversed without affecting performance.
- Nonmagnetic spool and housing assembly

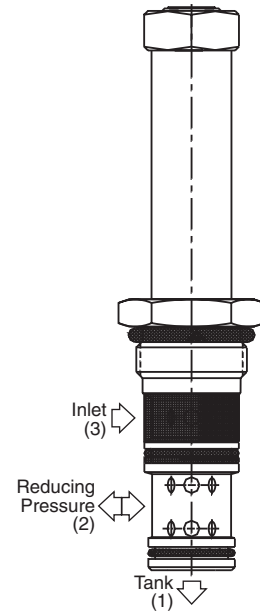
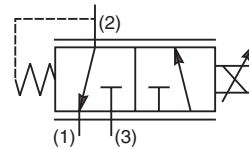

Specifications

Rated Flow (At 70 PSI ΔP)	30 LPM (8 GPM)								
Max. Regulated Pressure @ 75% Current (Using ‘SP’ Coil)	<table border="0"> <tr> <td>02</td> <td>14/17 Bar (200/240 PSI)</td> </tr> <tr> <td>03</td> <td>21/27 Bar (300/390 PSI)</td> </tr> <tr> <td>05</td> <td>29/38 Bar (420/550 PSI)</td> </tr> <tr> <td>09</td> <td>56/74 Bar (810/1080 PSI)</td> </tr> </table>	02	14/17 Bar (200/240 PSI)	03	21/27 Bar (300/390 PSI)	05	29/38 Bar (420/550 PSI)	09	56/74 Bar (810/1080 PSI)
02	14/17 Bar (200/240 PSI)								
03	21/27 Bar (300/390 PSI)								
05	29/38 Bar (420/550 PSI)								
09	56/74 Bar (810/1080 PSI)								
Max. Input Press. At Port 3	210 Bar (3000 PSI)								
Max. Drainage Flow In Regulating Zone	25 cc/min. When De-Energized 800 cc/min. In Regulating Zone At 21 Bar (300 PSI) Input Pressure								
Hysteresis @ 200 Hz PWM	3.5%								
Dead End Response Time	40 ms At Step Signal 0 To 75% of Nominal Voltage								
Cartridge Material	All parts steel. All operating parts hardened steel.								
Operating Temp. Range/Seals	-40°C to +93.3°C (Nitrile) (-40°F to +200°F) -31.7°C to +121.1°C (Fluorocarbon) (-25°F to +250°F)								
Fluid Compatibility/ Viscosity	Mineral-based or synthetic with lubricating properties at viscosities of 45 to 2000 SSU (6 to 420 cSt)								
Filtration	ISO Code 16/13, SAE Class 4 or better								
Approx. Weight	.13 kg (.28 lbs.)								
Cavity	3X (See BC Section for more details)								

Performance Curves

▲ PWM Current Regulator Recommended

Pressure Drop vs. Flow

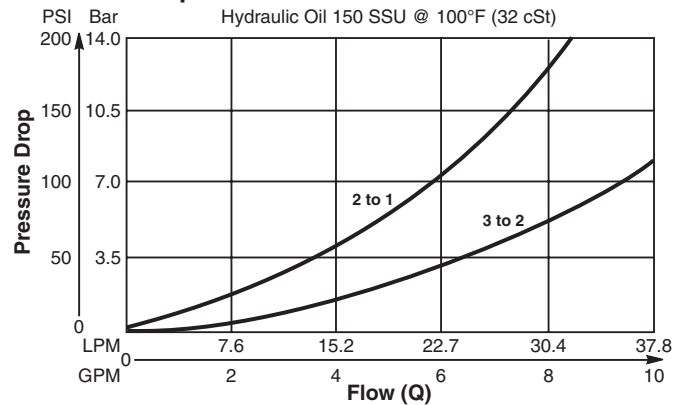

Pressure @ Port 2 vs. Input Current

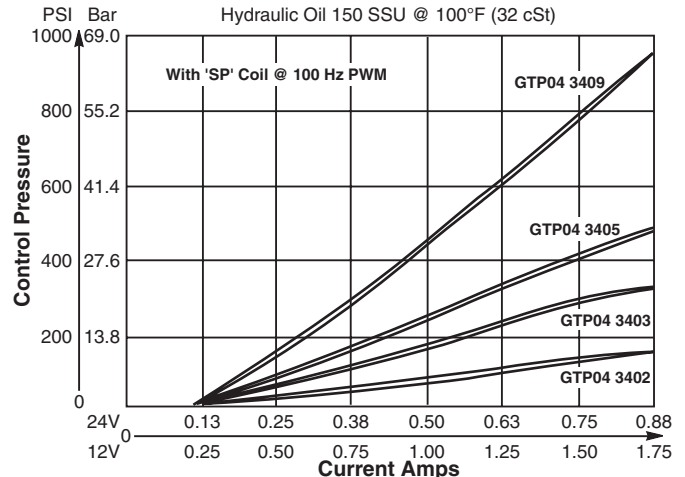

Dimensions Millimeters (Inches)

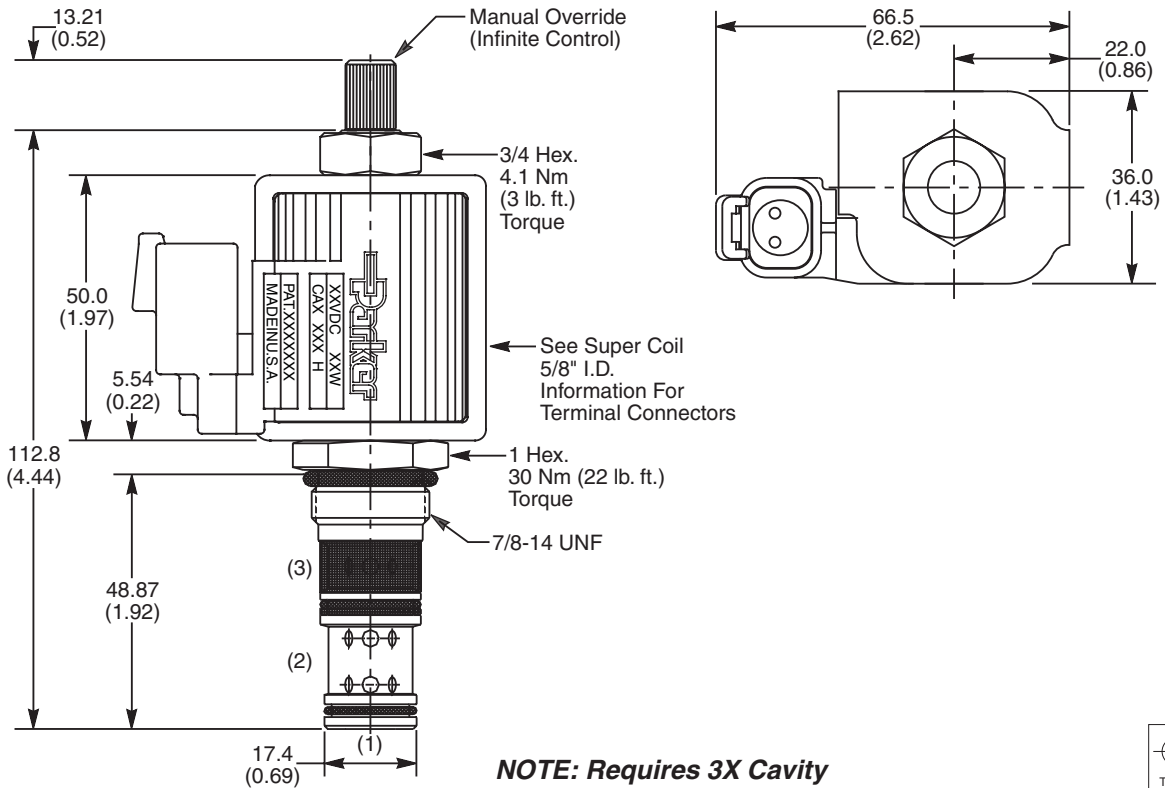

Ordering Information

GTP0434

10 Size Proportional Valve Style Override Option Filter Screen Seals Coil Type Coil Voltage Coil Termination

Code	Style (Maximum Regulated Pressure Range - SP Coil)
02	14/17 Bar (200/240 PSI)
03	21/27 Bar (300/390 PSI)
05	29/38 Bar (420/550 PSI)
09	56/74 Bar (810/1080 PSI)

Contact factory for other regulated pressure to 124 Bar (1800 PSI)

Code	Override Option
0	Not Required
5	Detented M.O.

Code	Filter Screen
1	60 Mesh Screen on Inlet Port

Code	Seals / Kit No.
N	Nitrile / Buna-N (Std.) (SK30081N-1)
V	Fluorocarbon / (SK30081V-1)

Code	Coil Type
Omit	Without Coil
SS	Super Coil - 18 Watts
SP	Super Coil - 28 Watts

Code	Coil Voltage
Omit	Without Coil
D012	12 VDC
D024	24 VDC

Code	Coil Termination
Omit	Without Coil
D	DIN Plug Face
A	Amp Jr. Timer*
L	Dual Lead Wire*
LS	Sealed Lead Wire*
H	Molded Deutsch*

See Super Coil 5/8" I.D.
 *DC Only

Order Bodies Separately

LB10

Line Body Porting Body Material

Code	Porting
553	1/2" SAE
554	3/8" BSP

Code	Body Material
A	Aluminum
S	Steel



- CV**
- Check Valves
- SH**
- Shuttle Valves
- LM**
- Load/Motor Controls
- FC**
- Flow Controls
- PC**
- Pressure Controls
- LE**
- Logic Elements
- DC**
- Directional Controls
- MV**
- Manual Valves
- SV**
- Solenoid Valves
- PV**
- Proportional Valves
- CE**
- Coils & Electronics
- BC**
- Bodies & Cavities
- TD**
- Technical Data

Technical Information

- CV** Check Valves
- SH** Shuttle Valves
- LM** Load/Motor Controls
- FC** Flow Controls
- PC** Pressure Controls
- LE** Logic Elements
- DC** Directional Controls
- MV** Manual Valves
- SV** Solenoid Valves
- PV** Proportional Valves
- CE** Coils & Electronics
- BC** Bodies & Cavities
- TD** Technical Data

General Description

Normally Closed Proportional Flow Control Valve. For additional information see Technical Tips on pages PV1-PV6.

Features

- On-off type solenoids
- Low hysteresis
- PWM signal preferred
- Manual override standard
- All external parts zinc plated

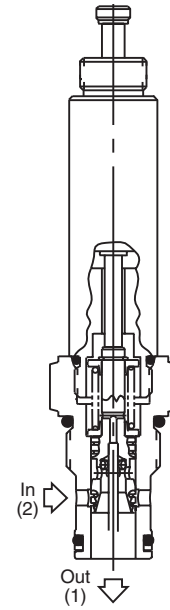
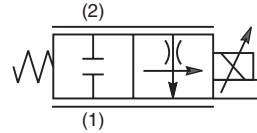
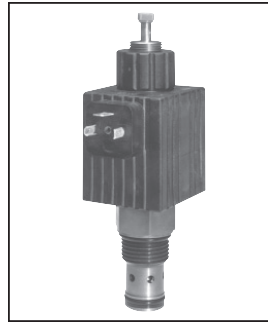

Specifications

Rated Flow Valve Fully Open	53 LPM (14 GPM)
Maximum Inlet Pressure	210 Bar (3000 PSI)
Hysteresis @ 200 Hz PWM	4%
Cracking (Dead band)	20% - 30% of Input Signal
Frequency	100 - 400 Hz (200 Hz Preferred)
Maximum Control Current	12 VDC 2.45A 24VDC 1.23A
Cartridge Material	All parts steel. All operating parts hardened steel.
Operating Temp. Range/Seals	-40°C to +93.3°C (Nitrile) (-40°F to +200°F) -31.7°C to +121.1°C (Fluorocarbon) (-25°F to +250°F)
Fluid Compatibility/Viscosity	Mineral-based or synthetic with lubricating properties at viscosities of 45 to 2000 SSU (6 to 420 cSt)
Filtration	ISO Code 16/13, SAE Class 4 or better
Approx. Weight	.32 kg (0.7 lbs.)
Cavity	C12-2 (See BC Section for more details)
Form Tool	Rougher None Finisher NFT12-2F

Performance Curves

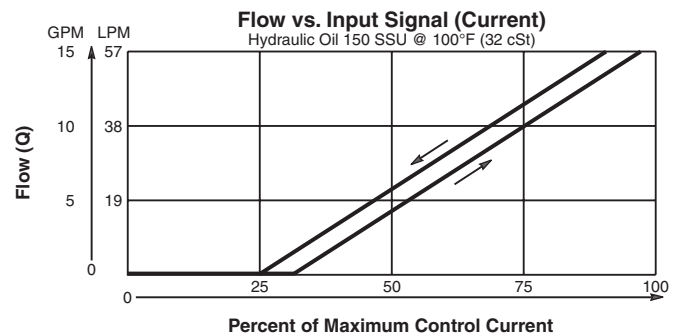
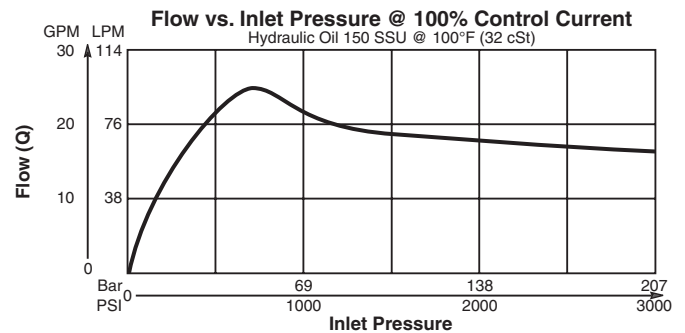
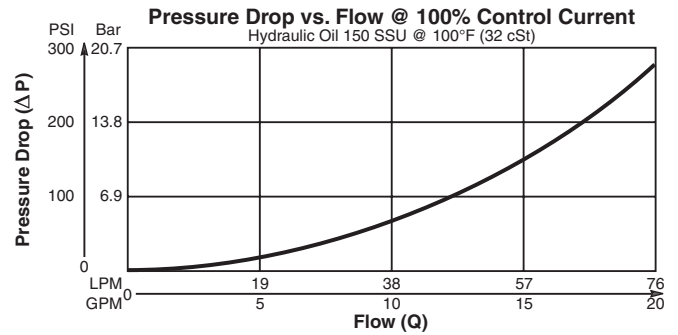

Dimensions Millimeters (Inches)

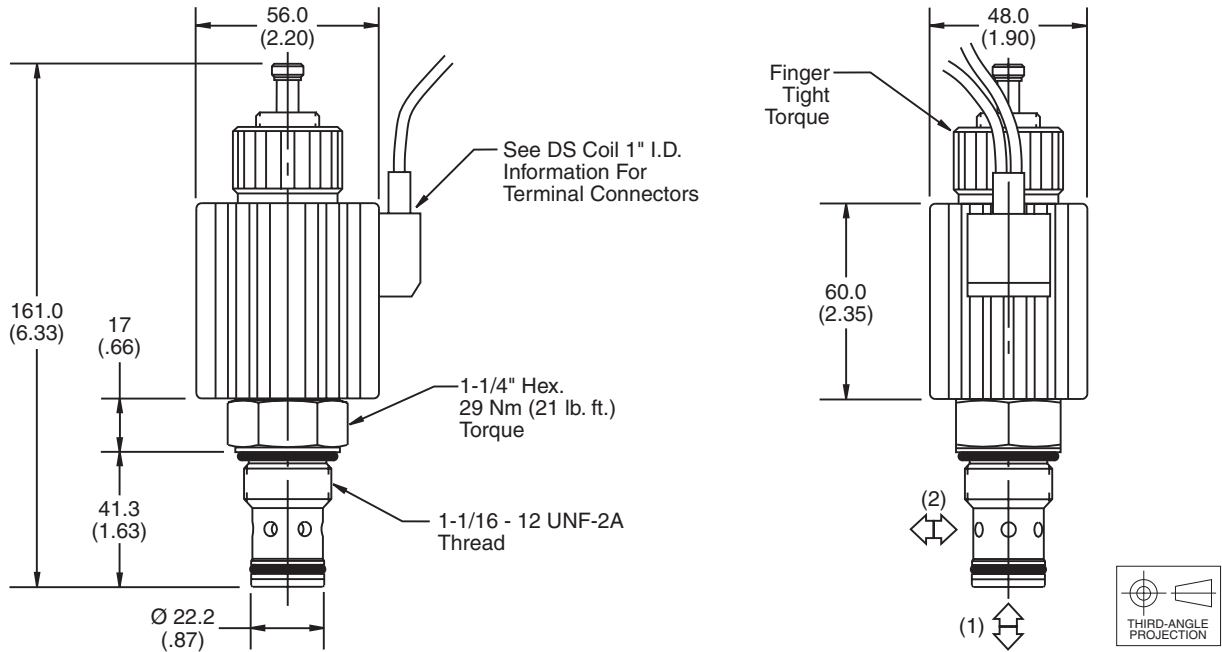

Ordering Information

DF122C14

12 Size Normally Closed Proportional Flow Control Valve **Override Options** **Seals** **Coil Voltage** **Coil Wattage** **Coil Termination** **Body Material** **Port Size**

Code	Override Options
Omit	Push Type with Extended Rod

Code	Coil Voltage
Omit	Cartridge without Coil
D012	12 VDC
D024	24 VDC

Code	Coil Termination
Omit	Cartridge without Coil
D	DIN
P	Dual Spade
W	Dual Wire

Code	Body Material
Omit	Steel
A	Aluminum

Code	Seals / Kit. No.
Omit	Nitrile / (SK12-2)
V	Fluorocarbon / (SK12-2V)

Code	Coil Wattage
Omit	Cartridge without Coil
H	High Watt

See DS Coil 1" I.D.

Code	Port Size	Body Part No.
12P	3/4" NTPF	(B12-2-*12P)
8T	SAE - 8	(B12-2-*8T)
12T	SAE - 12	(B12-2-*12T)

** Add "A" for aluminum, omit for steel.*

- CV
- Check Valves
- SH
- Shuttle Valves
- LM
- Load/Motor Controls
- FC
- Flow Controls
- PC
- Pressure Controls
- LE
- Logic Elements
- DC
- Directional Controls
- MV
- Manual Valves
- SV
- Solenoid Valves
- PV
- Proportional Valves
- CE
- Coils & Electronics
- BC
- Bodies & Cavities
- TD
- Technical Data

Technical Information

- CV** Check Valves
- SH** Shuttle Valves
- LM** Load/Motor Controls
- FC** Flow Controls
- PC** Pressure Controls
- LE** Logic Elements
- DC** Directional Controls
- MV** Manual Valves
- SV** Solenoid Valves
- PV** Proportional Valves
- CE** Coils & Electronics
- BC** Bodies & Cavities
- TD** Technical Data

General Description

Normally Closed Proportional Needle Valve. This valve is designed specifically for bleed off or unloading circuits. Back pressure will affect performance. For additional information see Technical Tips on pages PV1-PV6.

Features

- On-off type solenoids
- Low hysteresis
- PWM signal preferred
- All external parts zinc plated

Specifications

Rated Flow Valve Fully Open	High Watt Coil 150 LPM (40 GPM)
Maximum Inlet Pressure	210 Bar (3000 PSI)
Leakage at 150 SSU (32 cSt)	125 cc/min. (7.6 in ³ /min.)
Hysteresis @ 200 Hz PWM	4%
Cracking (Dead band)	20% - 30% of Input Signal
Frequency	100 - 400 Hz (200 Hz Preferred)
Maximum Control Current	12 VDC 24VDC High Watt 2.45A 1.23A
Cartridge Material	All parts steel. All operating parts hardened steel.
Operating Temp. Range/Seals	-40°C to +93.3°C (Nitrile) (-40°F to +200°F) -31.7°C to +121.1°C (Fluorocarbon) (-25°F to +250°F)
Fluid Compatibility/ Viscosity	Mineral-based or synthetic with lubricating properties at viscosities of 45 to 2000 SSU (6 to 420 cSt)
Filtration	ISO Code 16/13, SAE Class 4 or better
Approx. Weight	.34 kg (0.75 lbs.)
Cavity	C16-2 (See BC Section for more details)
Form Tool	Rougher None Finisher NFT16-2F

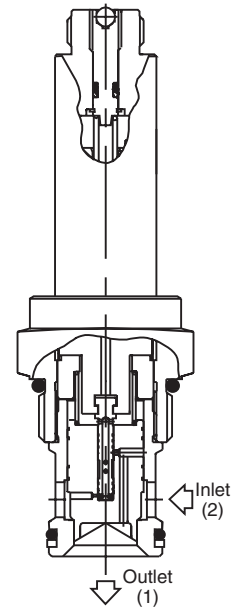
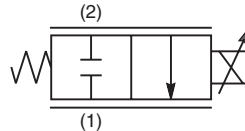
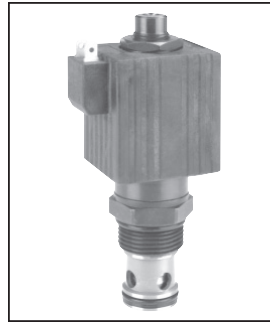

Performance Curves

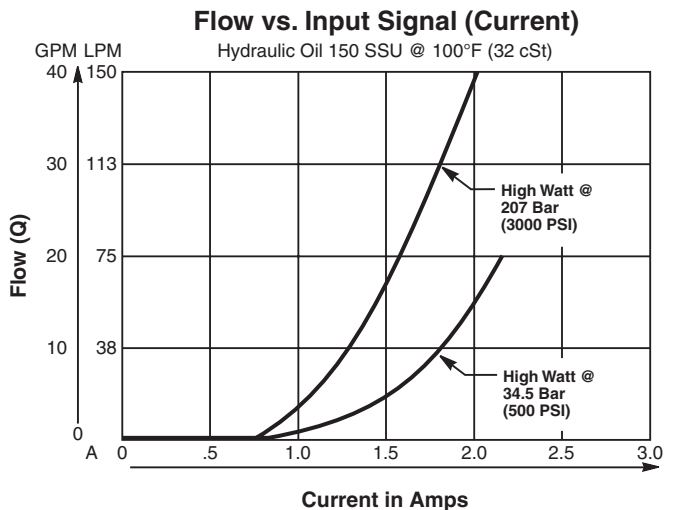
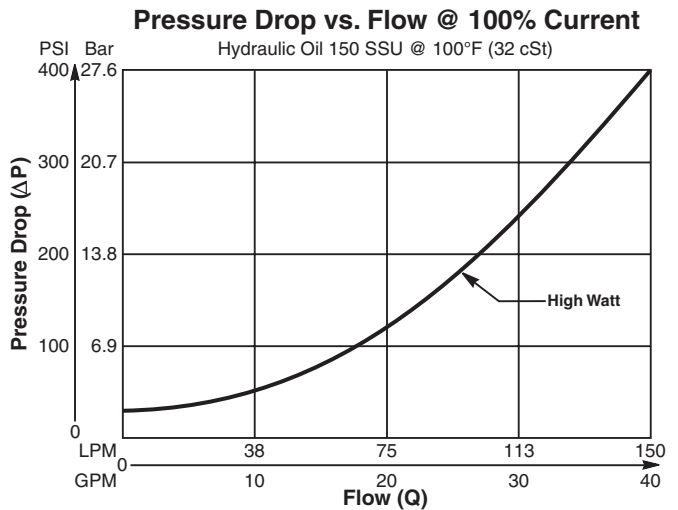

Dimensions Millimeters (Inches)

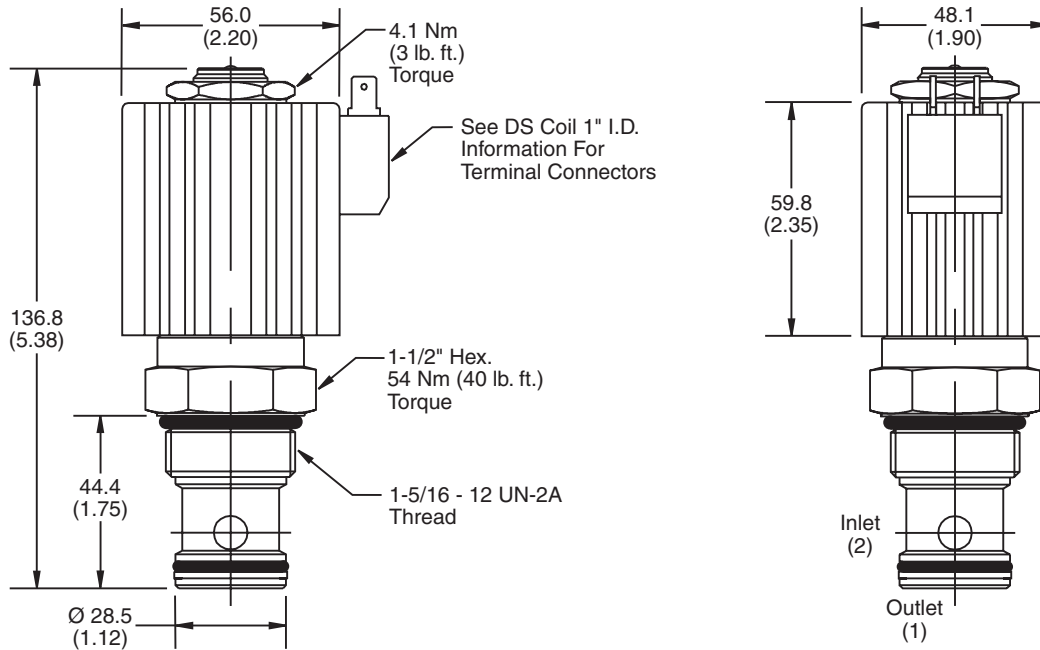

Ordering Information

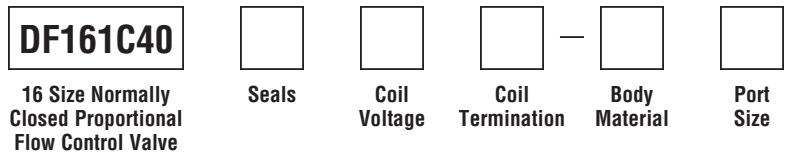

Code	Seals / Kit. No.
Omit	Nitrile / (SK16-2)
V	Fluorocarbon / (SK16-2V)

Code	Coil Voltage
Omit	Cartridge without Coil
D012	12 VDC
D024	24 VDC

Code	Coil Termination
Omit	Cartridge without Coil
D	DIN
P	Dual Spade
W	Dual Wire

See DS Coil 1" I.D.

Code	Body Material
Omit	Steel
A	Aluminum

Code	Port Size	Body Part No.
12P	3/4" NTPF	(B16-2-*12P)
16P	1" NTPF	(B16-2-*16P)
8T	SAE - 8	(B16-2-*8T)
12T	SAE - 12	(B16-2-*12T)
16T	SAE - 16	(B16-2-*16T)
12B	3/4" BSPG	(B16-2-12B)†
16B	1" BSPG	(B16-2-*16B)

* Add "A" for aluminum, omit for steel.
 † Steel body only.



- CV**
Check Valves
- SH**
Shuttle Valves
- LM**
Load/Motor Controls
- FC**
Flow Controls
- PC**
Pressure Controls
- LE**
Logic Elements
- DC**
Directional Controls
- MV**
Manual Valves
- SV**
Solenoid Valves
- PV**
Proportional Valves
- CE**
Coils & Electronics
- BC**
Bodies & Cavities
- TD**
Technical Data

Technical Information

- CV** Check Valves
- SH** Shuttle Valves
- LM** Load/Motor Controls
- FC** Flow Controls
- PC** Pressure Controls
- LE** Logic Elements
- DC** Directional Controls
- MV** Manual Valves
- SV** Solenoid Valves
- PV** Proportional Valves
- CE** Coils & Electronics
- BC** Bodies & Cavities
- TD** Technical Data

General Description

Normally Closed Proportional Needle Valve. This valve is designed specifically for bleed off or unloading circuits. Back pressure will affect performance. For additional information see Technical Tips on pages PV1-PV6.

Features

- On-off type solenoids
- Low hysteresis
- PWM signal preferred
- All external parts zinc plated

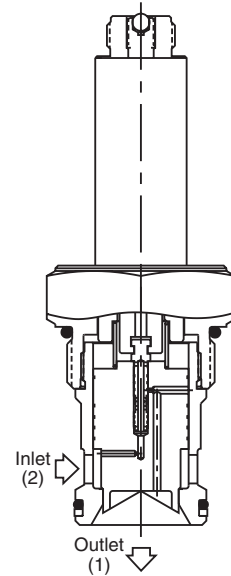
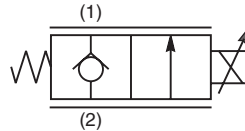
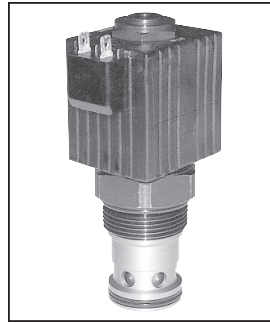

Specifications

Rated Flow Valve Fully Open	Low Watt 180 LPM (48 GPM) High Watt 227 LPM (60 GPM)
Maximum Inlet Pressure	210 Bar (3000 PSI)
Leakage at 150 SSU (32 cSt)	125 cc/min. (7.6 in ³ /min.)
Hysteresis @ 200 Hz PWM	4%
Cracking (Dead band)	20% - 30% of Input Signal
Frequency	100 - 400 Hz (200 Hz Preferred)
Maximum Control Current	12 VDC 24VDC Low Watt 1.75A .91A High Watt 2.45A 1.23A
Cartridge Material	All parts steel. All operating parts hardened steel.
Operating Temp. Range/Seals	-40°C to +93.3°C (Nitrile) (-40°F to +200°F) -31.7°C to +121.1°C (Fluorocarbon) (-25°F to +250°F)
Fluid Compatibility/Viscosity	Mineral-based or synthetic with lubricating properties at viscosities of 45 to 2000 SSU (6 to 420 cSt)
Filtration	ISO Code 16/13, SAE Class 4 or better
Approx. Weight	.34 kg (0.75 lbs.)
Cavity	C20-2 (See BC Section for more details)
Form Tool	Rougher None Finisher NFT20-2F

Performance Curves

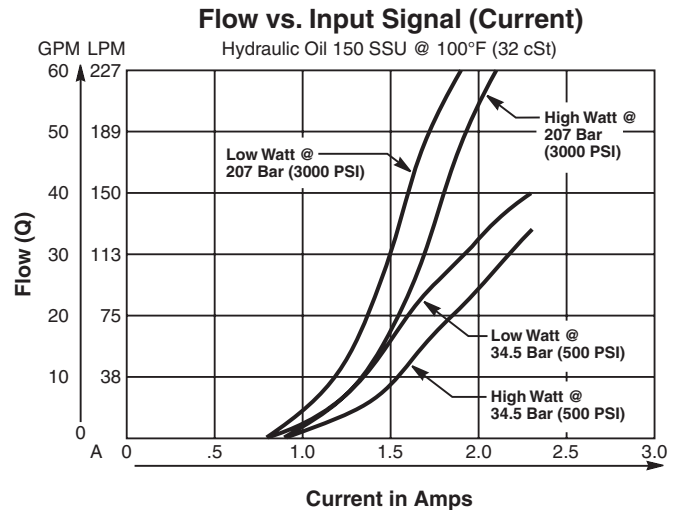
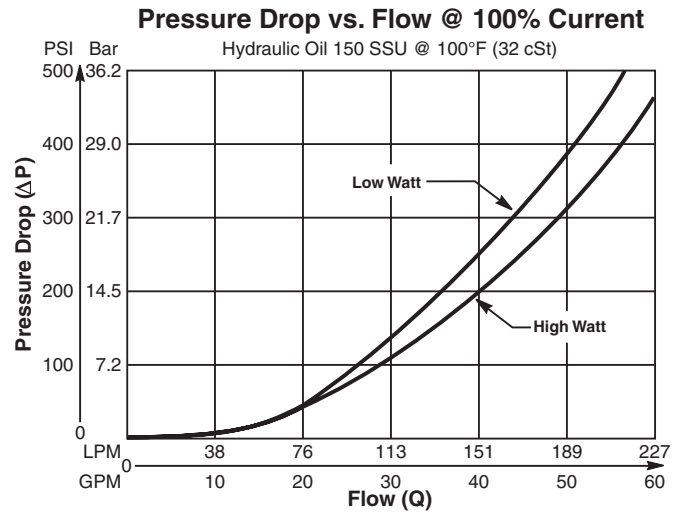

Dimensions Millimeters (Inches)

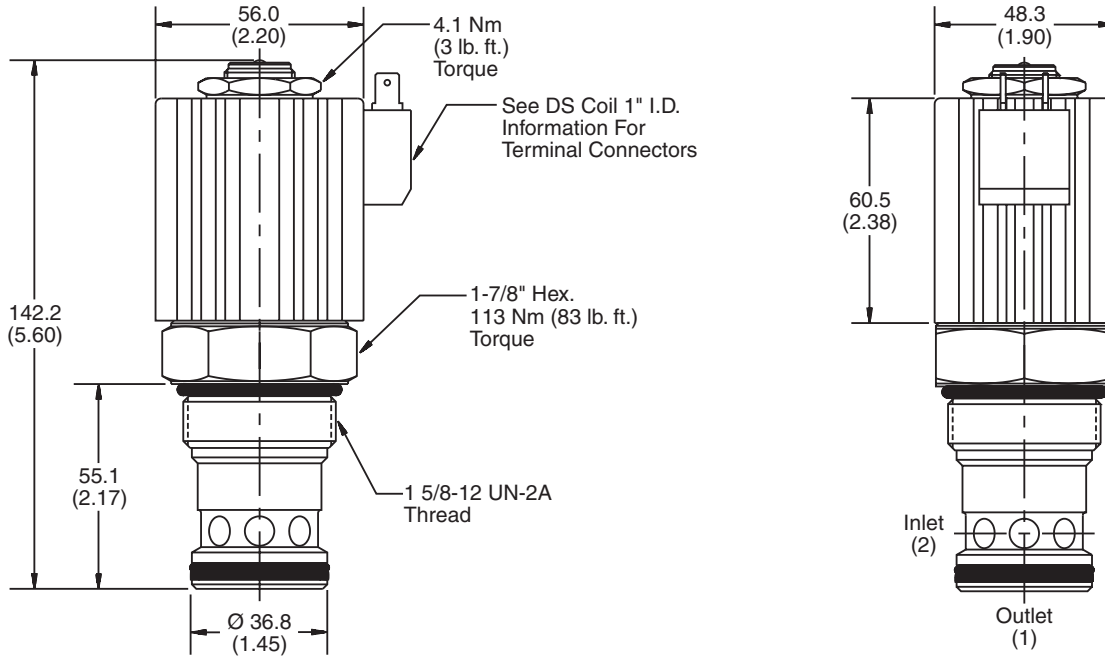

Ordering Information

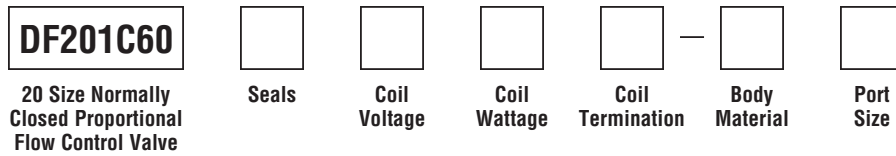

Code	Seals / Kit. No.
Omit	Nitrile / (SK20-2)
V	Fluorocarbon / (SK20-2V)

Code	Coil Voltage
Omit	Cartridge without Coil
D012	12 VDC
D024	24 VDC

Code	Coil Termination
Omit	Cartridge without Coil
D	DIN
P	Dual Spade
W	Dual Wire

Code	Body Material
Omit	Steel
A	Aluminum

Code	Coil Wattage
Omit	Cartridge without Coil
L	Low Watt
H	High Watt

See DS Coil 1" I.D.

Code	Port Size	Body Part No.
20T	SAE - 20	(B20-2-*20T)
20B	1-1/4" BSPG	(B20-2-*20B)

* Add "A" for aluminum, omit for steel.

Technical Information

- CV** Check Valves
- SH** Shuttle Valves
- LM** Load/Motor Controls
- FC** Flow Controls
- PC** Pressure Controls
- LE** Logic Elements
- DC** Directional Controls
- MV** Manual Valves
- SV** Solenoid Valves
- PV** Proportional Valves
- CE** Coils & Electronics
- BC** Bodies & Cavities
- TD** Technical Data

General Description

2 Way, Normally Closed, Proportional Flow Regulator Valve. Partially Pressure Compensated. For additional information see Technical Tips on pages PV1-PV6.

Features

- Analog Proportional Partially Pressure Compensated Flow Regulator regulates flow proportionally to the input solenoid current.
- A low cost valve designed to be used in applications where fine pressure compensation is not required.
- One piece cartridge housing ensures internal concentricity
- Coil: Waterproof, hermetically sealed, requires no O’Rings; Symmetrical coil can be reversed without affecting performance.
- Nonmagnetic spool and housing assembly
- Factory-adjusted low variation option (Model “L”) is available for applications where low variation of flow from valve to valve is essential at a given current or when an external pressure compensator is used.

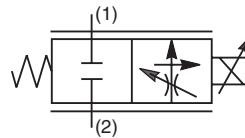
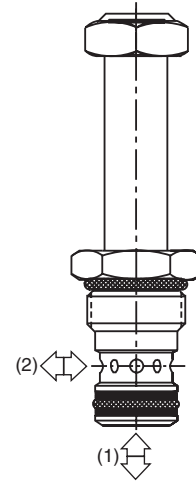

Specifications

Rated Flow @ 210 Bar (3000 PSI)	Standard (‘SS’ Coil) 2 to 1 13.3 LPM (3.5 GPM) 1 to 2 9.5 LPM (2.5 GPM) High Flow (‘SP’ Coil) 2 to 1 22.8 LPM (6.0 GPM) 1 to 2 15.0 LPM (4.0 GPM)
Preferable Input Port For Best Hysteresis	Port 1
Hysteresis @ 100 Hz PWM	<10%
Cracking Pressure	25% of Input Current
Variation of Flow @ 35% of Rated Current & Constant ΔP Maintained By Pressure Compensator	Standard Model Up To ±20% Of Rated Flow Model “L” ±7% Of Rated Flow
Cartridge Material	All parts steel. All operating parts hardened steel.
Operating Temp. Range/Seals	-40°C to +93.3°C (Nitrile) (-40°F to +200°F) -31.7°C to +121.1°C (Fluorocarbon) (-25°F to +250°F)
Fluid Compatibility/ Viscosity	Mineral-based or synthetic with lubricating properties at viscosities of 45 to 2000 SSU (6 to 420 cSt)
Filtration	ISO Code 16/13, SAE Class 4 or better
Approx. Weight	.08 kg (.17 lbs.)
Cavity	2X (See BC Section for more details)

Performance Curves

▲ PWM Current Regulator Recommended

Flow vs. Input Current

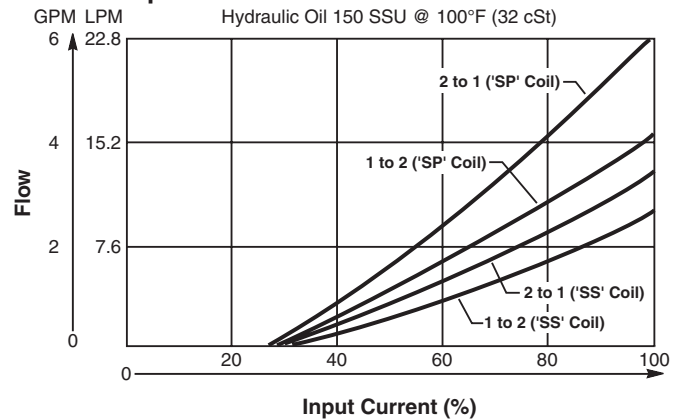

Flow Regulation (Measured at 75% of Rated Current)

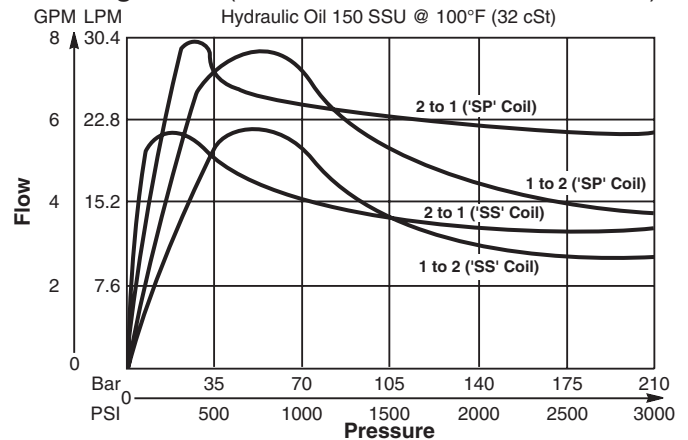

Dimensions Millimeters (Inches)

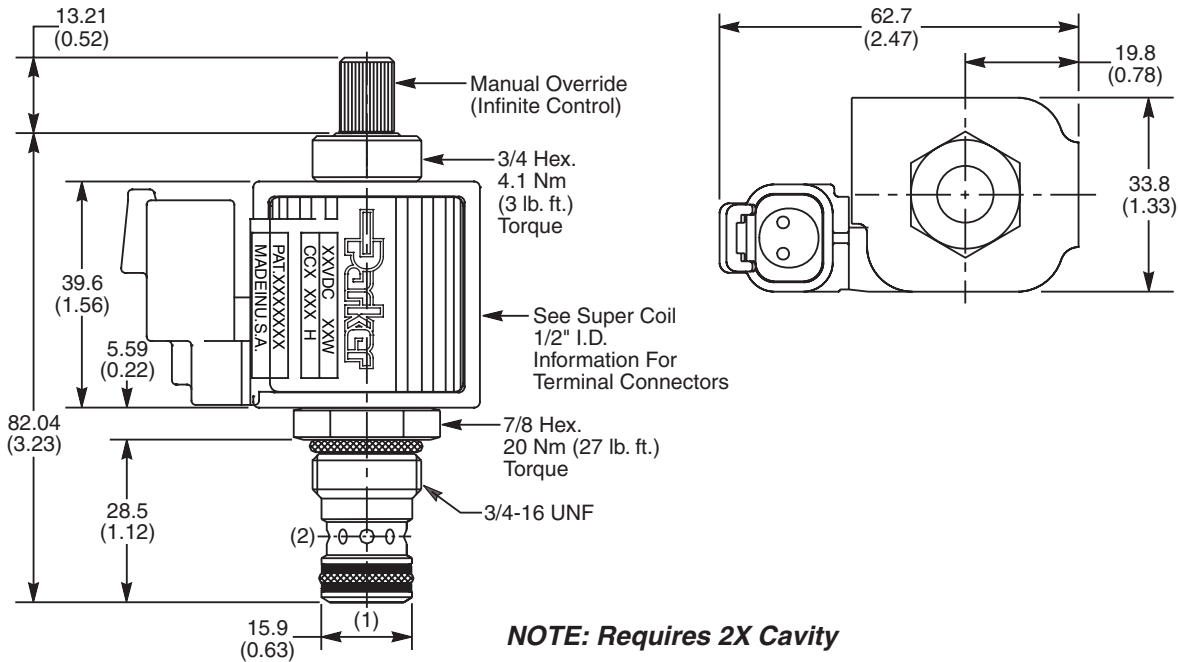

Ordering Information

HP02C	21							
08 Size Proportional Valve	Style	Override Option	Filter Screen	Seals	Flow Variation	Coil Type	Coil Voltage	Coil Termination

Code	Style (Maximum Regulated Flow)
21	Standard ('SS' Coil) 13.3 LPM (3.5 GPM)
21	High Flow ('SP' Coil) 22.8 LPM (6.0 GPM)

Code	Filter Screen
0	Not Available

Code	Seals / Kit No.
N	Nitrile / Buna-N (Std.) (SK30076N-1)
V	Fluorocarbon / (SK30076V-1)

Code	Flow Variation
Omit	Standard Up to ±20% of Rated Flow
L	Low Variation (±7% of Rated Flow)

Code	Coil Voltage
Omit	Without Coil
D012	12 VDC
D024	24 VDC

Code	Override Option
0	Not Required
5	Detented M.O. (Infinite Control)

Code	Coil Type
Omit	Without Coil
SS	Super Coil - 14 Watts
SP	Super Coil - 19 Watts

Code	Coil Termination
Omit	Without Coil
D	DIN Plug Face
A	Amp Jr. Timer*
L	Dual Lead Wire*
LS	Sealed Lead Wire*
H	Molded Deutsch*

See Super Coil 1/2" I.D.
*DC Only

Order Bodies Separately

LB10		
Line Body	Porting	Body Material

Code	Porting
513	3/8" SAE
515	1/4" BSP

Code	Body Material
A	Aluminum
S	Steel



- CV**
Check Valves
- SH**
Shuttle Valves
- LM**
Load/Motor Controls
- FC**
Flow Controls
- PC**
Pressure Controls
- LE**
Logic Elements
- DC**
Directional Controls
- MV**
Manual Valves
- SV**
Solenoid Valves
- PV**
Proportional Valves
- CE**
Coils & Electronics
- BC**
Bodies & Cavities
- TD**
Technical Data

Technical Information

- CV** Check Valves
- SH** Shuttle Valves
- LM** Load/Motor Controls
- FC** Flow Controls
- PC** Pressure Controls
- LE** Logic Elements
- DC** Directional Controls
- MV** Manual Valves
- SV** Solenoid Valves
- PV** Proportional Valves
- CE** Coils & Electronics
- BC** Bodies & Cavities
- TD** Technical Data

General Description

2 Way, Normally Closed, Proportional Flow Regulator Valve. Pressure Compensated. For additional information see Technical Tips on pages PV1-PV6.

Features

- One piece cartridge housing ensures internal concentricity
- Coil: Waterproof, hermetically sealed, requires no O’Rings; Symmetrical coil can be reversed without affecting performance.
- Nonmagnetic spool and housing assembly
- Factory-adjusted low variation option (Model “L”) is available for applications where low variation of flow from valve to valve is essential at a given current.

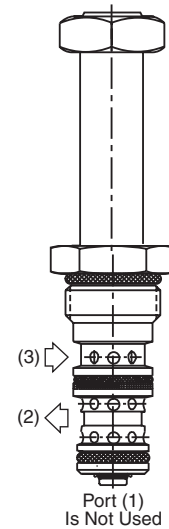
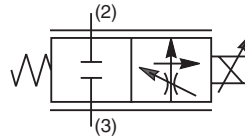

Specifications

Rated Flow	20 7.5 LPM (2 GPM) Low Flow ('SS' Coil)
	21 15 LPM (4 GPM) Standard ('SS' Coil)
	21 23 LPM (6 GPM) High Flow ('SP' Coil)
Maximum Input Pressure At Port 2	210 Bar (3000 PSI)
Minimum Pressure Differential	20 6.9 Bar (150 PSI) Low Flow
	21 13.8 Bar (200 PSI) Standard
	21 20.7 Bar (300 PSI) High Flow
Maximum Internal Leakage	570 cc (35 cu. in.) @ 210 Bar (3000 PSI)
Hysteresis @ 100 Hz PWM	<10% (Low Flow and Standard) <3% (High Flow)
Cracking Pressure	25% of Input Signal
Variation of Flow @ 35% of Rated Current	Standard Model Up To ±20% Of Rated Flow
	Model “L” ±7% Of Rated Flow
Cartridge Material	All parts steel. All operating parts hardened steel.
Operating Temp. Range/Seals	-40°C to +93.3°C (Nitrile) (-40°F to +200°F) -31.7°C to +121.1°C (Fluorocarbon) (-25°F to +250°F)
Fluid Compatibility/ Viscosity	Mineral-based or synthetic with lubricating properties at viscosities of 45 to 2000 SSU (6 to 420 cSt)
Filtration	ISO Code 16/13, SAE Class 4 or better
Approx. Weight	.08 kg (.17 lbs.)
Cavity	C08-3 (See BC Section for more details)

Performance Curves

▲ PWM Current Regulator Recommended

Flow vs. Input Current

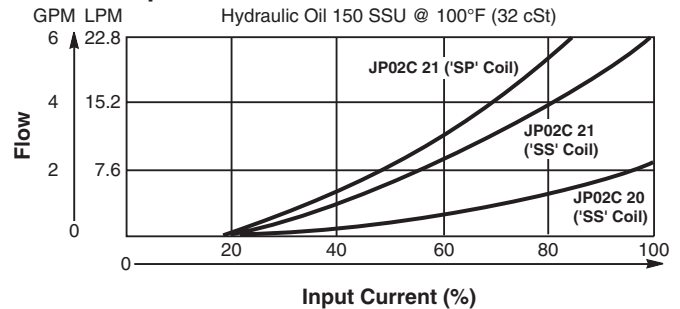

Flow Regulation (Measured 75% of Rated Current)

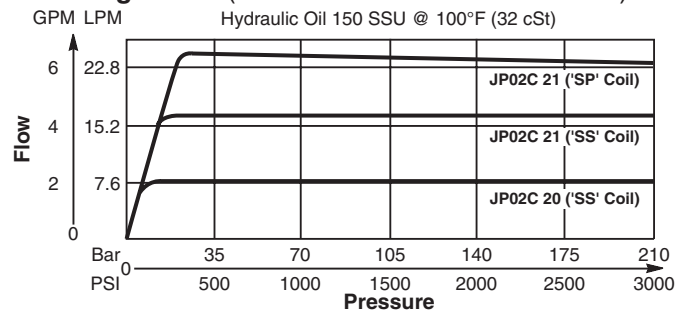

Pressure Drop vs. Flow

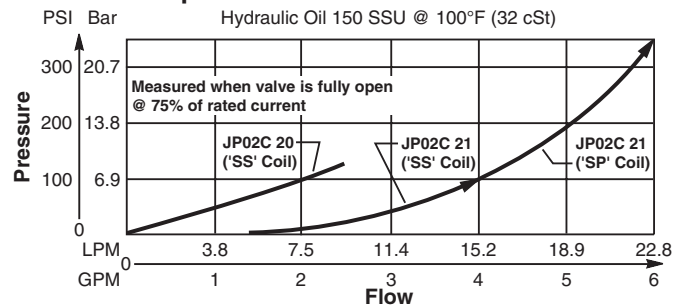

Dimensions Millimeters (Inches)

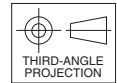
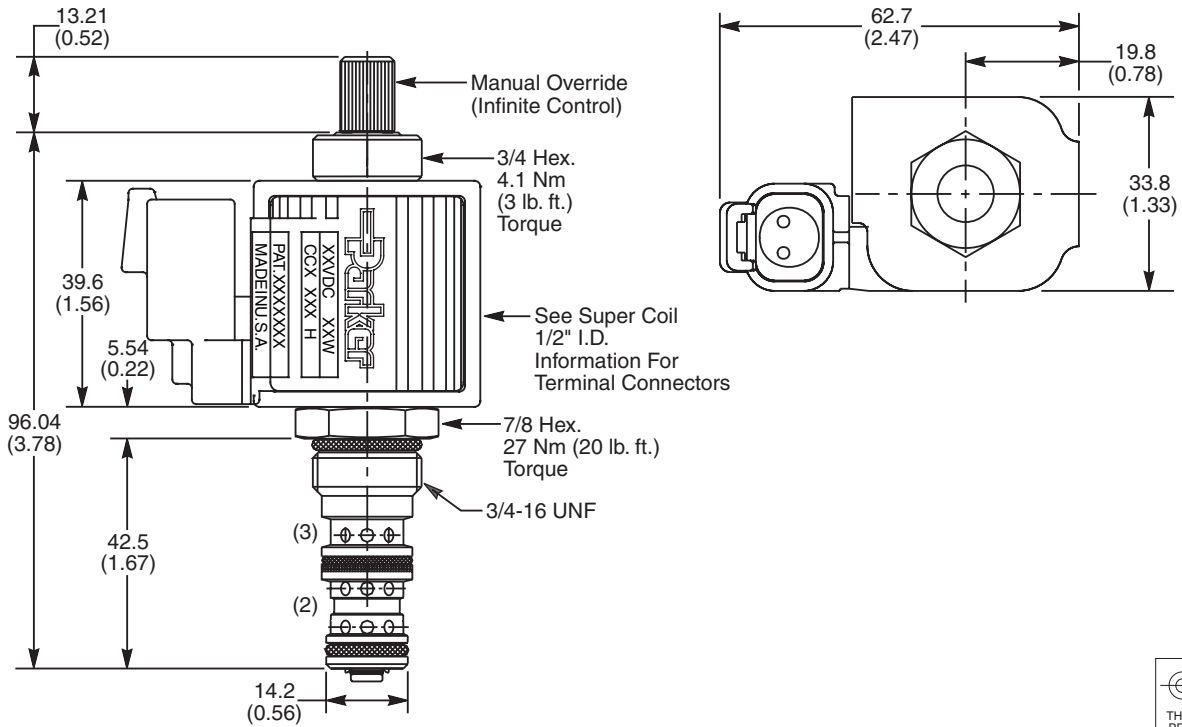

Ordering Information

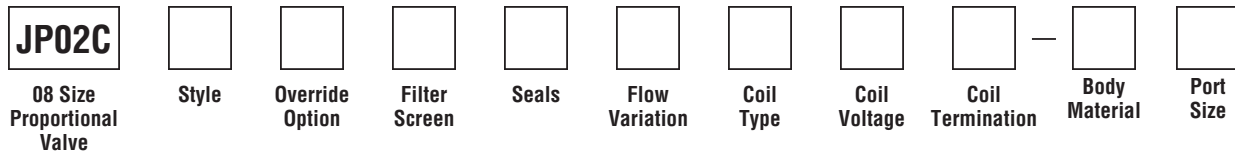

Code	Style (Maximum Regulated Flow)
20	Low Flow ('SS' Coil) 7.5 LPM (2 GPM)
21	Standard ('SS' Coil) 15 LPM (4 GPM)
21	High Flow ('SP' Coil) 23 LPM (6 GPM)

Code	Seals / Kit No.
N	Nitrile / Buna-N (Std.) (SK30105N-1)
V	Fluorocarbon / (SK30105V-1)

Code	Coil Voltage
Omit	Without Coil
D012	12 VDC
D024	24 VDC

Code	Body Material
Omit	Steel
A	Aluminum

Code	Override Option
0	Not Required
5	Detented M.O. (Infinite Control)

Code	Flow Variation
Omit	Standard Up to ±20% of Rated Flow
L	Low Variation (±7% of Rated Flow)

Code	Coil Termination
Omit	Without Coil
D	DIN Plug Face
A	Amp Jr. Timer*
L	Dual Lead Wire*
LS	Sealed Lead Wire*
H	Molded Deutsch*

Code	Port Size	Body Part No.
Omit	Cartridge Only	
4P	1/4" NPTF	(B08-3-*4P)
4T	SAE-4	(B08-3-*4T)
6T	SAE-6	(B08-3-*6T)
6B	3/8" BSPG	(B08-3-*6B)

* Add "A" for aluminum, omit for steel.

Code	Filter Screen
0	Not Available
1	60 Mesh Screen on Port 2

Code	Coil Type
Omit	Without Coil
SS	Super Coil - 14 Watts
SP	Super Coil - 19 Watts

See Super Coil 1/2" I.D.
*DC Only

- CV
- Check Valves
- SH
- Shuttle Valves
- LM
- Load/Motor Controls
- FC
- Flow Controls
- PC
- Pressure Controls
- LE
- Logic Elements
- DC
- Directional Controls
- MV
- Manual Valves
- SV
- Solenoid Valves
- PV
- Proportional Valves
- CE
- Coils & Electronics
- BC
- Bodies & Cavities
- TD
- Technical Data

Technical Information

- CV** Check Valves
- SH** Shuttle Valves
- LM** Load/Motor Controls
- FC** Flow Controls
- PC** Pressure Controls
- LE** Logic Elements
- DC** Directional Controls
- MV** Manual Valves
- SV** Solenoid Valves
- PV** Proportional Valves
- CE** Coils & Electronics
- BC** Bodies & Cavities
- TD** Technical Data

General Description

2 Way, Normally Closed, Proportional Flow Regulator Valve. Partially Pressure Compensated. For additional information see Technical Tips on pages PV1-PV6.

Features

- Analog Proportional Partially Pressure Compensated Flow Regulator regulates flow proportionally to the input solenoid current.
- A low cost valve designed to be used in applications where fine pressure compensation is not required.
- One piece cartridge housing ensures internal concentricity
- Coil: Waterproof, hermetically sealed, requires no O’Rings; Symmetrical coil can be reversed without affecting performance.
- Nonmagnetic spool and housing assembly
- Factory-adjusted low variation option (Model “L”) is available for applications where low variation of flow from valve to valve is essential at a given current or when an external pressure compensator is used.

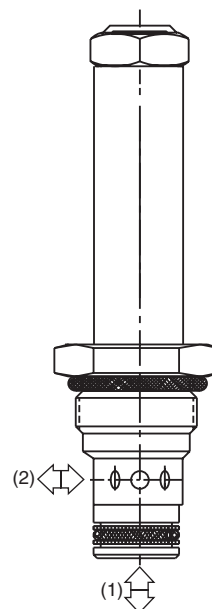
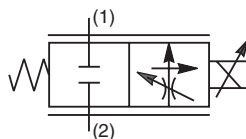

Specifications

Rated Flow 2 to 1 @ 210 Bar (3000 PSI)	Standard ('SS' Coil) 30 LPM (8 GPM) High Flow ('SP' Coil) 36 LPM (9.5 GPM)
Preferable Input Port For Best Hysteresis	Port 1
Hysteresis @ 100 Hz PWM	<10%
Cracking Pressure	21% of Rated Current (Standard) 17% of Rated Current (High Flow)
Variation of Flow @ 35% of Rated Current & Constant Pressure Compensator	Standard Model Up To ±5% Of Rated Flow Model "L" ±2% Of Rated Flow
Cartridge Material	All parts steel. All operating parts hardened steel.
Operating Temp. Range/Seals	-40°C to +93.3°C (Nitrile) (-40°F to +200°F) -31.7°C to +121.1°C (Fluorocarbon) (-25°F to +250°F)
Fluid Compatibility/ Viscosity	Mineral-based or synthetic with lubricating properties at viscosities of 45 to 2000 SSU (6 to 420 cSt)
Filtration	ISO Code 16/13, SAE Class 4 or better
Approx. Weight	.12 kg (.26 lbs.)
Cavity	C10-2 (See BC Section for more details)

Performance Curves

▲ PWM Current Regulator Recommended

Flow vs. Input Current

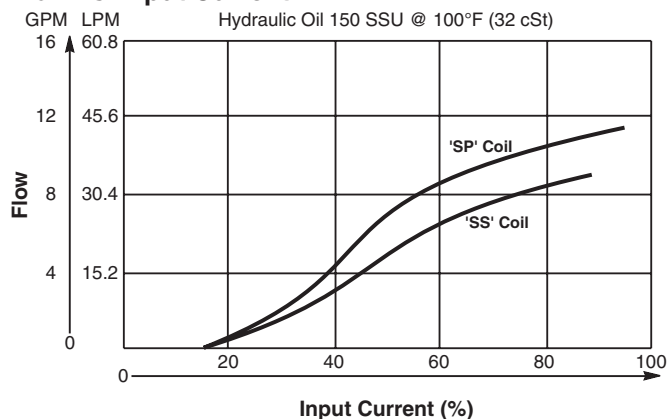

Flow Regulation

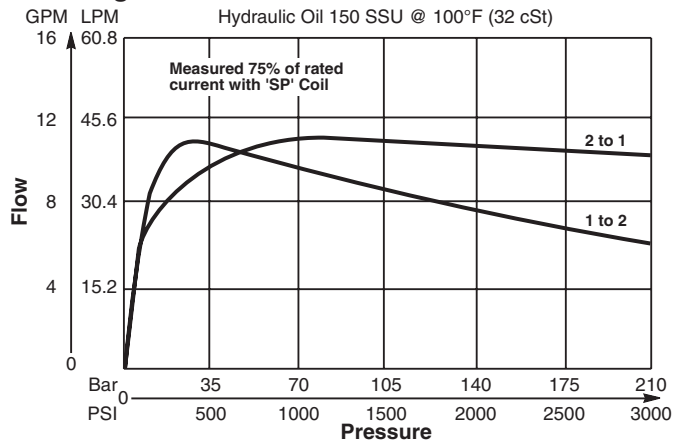

Dimensions Millimeters (Inches)

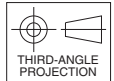
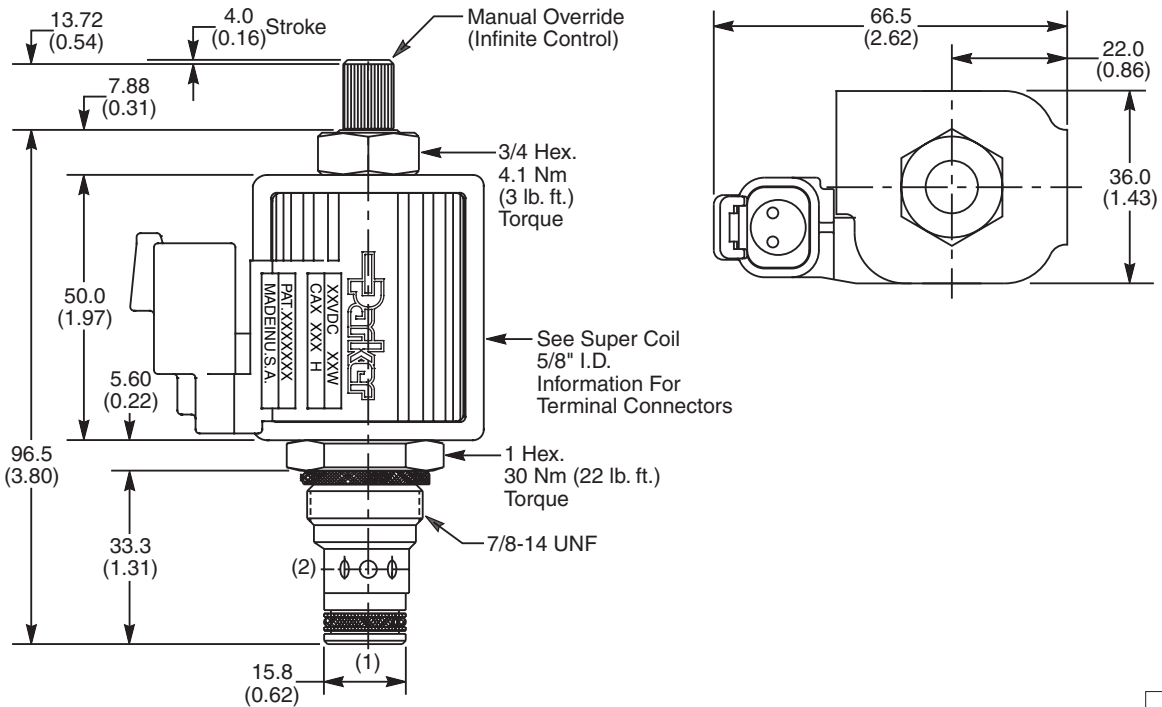

Ordering Information

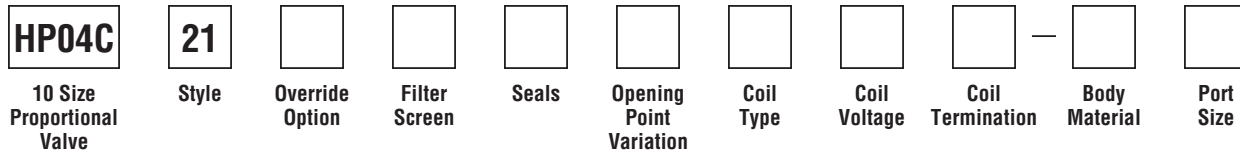

Code	Style (Maximum Regulated Flow)
21	Standard ('SS' Coil) 30 LPM (8 GPM)
21	High Flow ('SP' Coil) 36 LPM (9.5 GPM)

Code	Seals / Kit No.
N	Nitrile / Buna-N (Std.) (SK30503N-1)
V	Fluorocarbon / (SK30503V-1)

Code	Coil Voltage
Omit	Without Coil
D012	12 VDC
D024	24 VDC

Code	Body Material
Omit	Steel
A	Aluminum

Code	Override Option
0	Not Required
5	Detented M.O. (Infinite Control)

Code	Flow Variation
Omit	Standard Up to ±5% of Current
L	Low Variation (±2% of Current Flow)

Code	Coil Termination
Omit	Without Coil
D	DIN Plug Face
A	Amp Jr. Timer*
L	Dual Lead Wire*
LS	Sealed Lead Wire*
H	Molded Deutsch*

Code	Port Size	Body Part No.
Omit	Cartridge Only	
4P	1/4" NPTF	(B10-2-*4P)
6P	3/8" NPTF	(B10-2-*6P)
8P	1/2" NPTF	(B10-2-*8P)
6T	SAE-6	(B10-2-*6T)
8T	SAE-8	(B10-2-*8T)
T8T	SAE-8	(B10-2-T8T)†
6B	3/8" BSPG	(B10-2-*6B)

Code	Filter Screen
0	Not Available

Code	Coil Type
Omit	Without Coil
SS	Super Coil - 18 Watts
SP	Super Coil - 28 Watts

See Super Coil 5/8" I.D.
*DC Only

* Add "A" for aluminum, omit for steel.
† Steel body only.

- CV
- Check Valves
- SH
- Shuttle Valves
- LM
- Load/Motor Controls
- FC
- Flow Controls
- PC
- Pressure Controls
- LE
- Logic Elements
- DC
- Directional Controls
- MV
- Manual Valves
- SV
- Solenoid Valves
- PV
- Proportional Valves
- CE
- Coils & Electronics
- BC
- Bodies & Cavities
- TD
- Technical Data

Technical Information

- CV** Check Valves
- SH** Shuttle Valves
- LM** Load/Motor Controls
- FC** Flow Controls
- PC** Pressure Controls
- LE** Logic Elements
- DC** Directional Controls
- MV** Manual Valves
- SV** Solenoid Valves
- PV** Proportional Valves
- CE** Coils & Electronics
- BC** Bodies & Cavities
- TD** Technical Data

General Description

2 Way, Normally Closed, Proportional Flow Regulator Valve. Pressure Compensated. For additional information see Technical Tips on pages PV1-PV6.

Features

- One piece cartridge housing ensures internal concentricity
- Coil: Waterproof, hermetically sealed, requires no O’Rings; Symmetrical coil can be reversed without affecting performance.
- Nonmagnetic spool and housing assembly
- Factory-adjusted low variation option (Model “L”) is available for applications where low variation of flow from valve to valve is essential at a given current.

Specifications

Rated Flow	21	30 LPM (8 GPM) Standard (‘SS’ Coil)
	21	36 LPM (9.5 GPM) High Flow (‘SP’ Coil)
Maximum Input Pressure At Port 2	210 Bar (3000 PSI)	
Minimum Pressure Differential	21	13.8 Bar (200 PSI) Standard
	21	20.7 Bar (300 PSI) High Flow
Maximum Internal Leakage	780 cc (46 cu. in.) @ 210 Bar (3000 PSI)	
Hysteresis @ 100 Hz PWM	7%	
Cracking Pressure	25% of Input Signal	
Variation of Flow @ 35% of Rated Current	Standard Model Up To ±20% Of Rated Flow	
	Model “L” ±7% Of Rated Flow	
Cartridge Material	All parts steel. All operating parts hardened steel.	
Operating Temp. Range/Seals	-40°C to +93.3°C (Nitrile) (-40°F to +200°F) -31.7°C to +121.1°C (Fluorocarbon) (-25°F to +250°F)	
Fluid Compatibility/ Viscosity	Mineral-based or synthetic with lubricating properties at viscosities of 45 to 2000 SSU (6 to 420 cSt)	
Filtration	ISO Code 16/13, SAE Class 4 or better	
Approx. Weight	.13 kg (.28 lbs.)	
Cavity	3X (See BC Section for more details)	

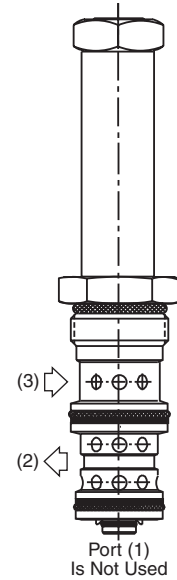
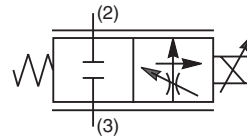

Performance Curves

▲ PWM Current Regulator Recommended

Flow vs. Input Signal

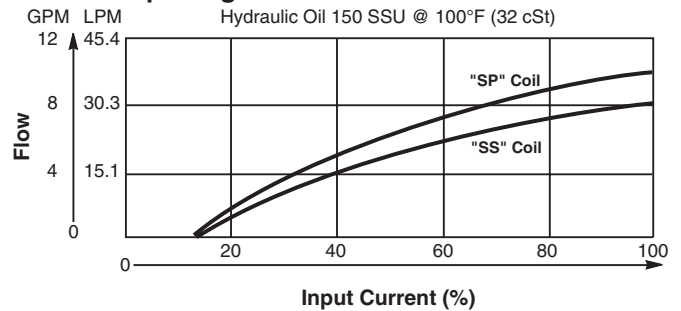

Flow Regulation (Measured 75% of Rated Current)

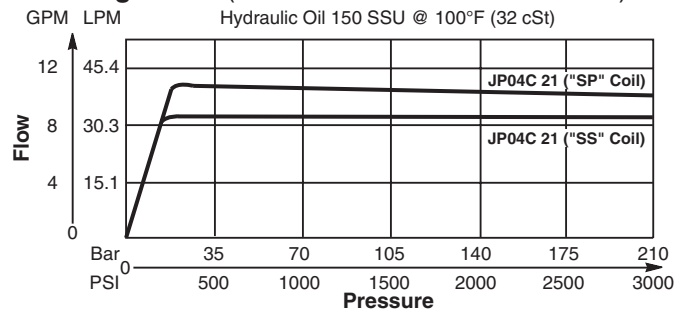

Pressure Drop vs. Flow

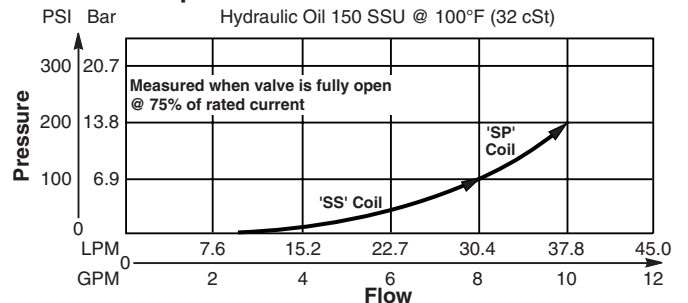

Dimensions Millimeters (Inches)

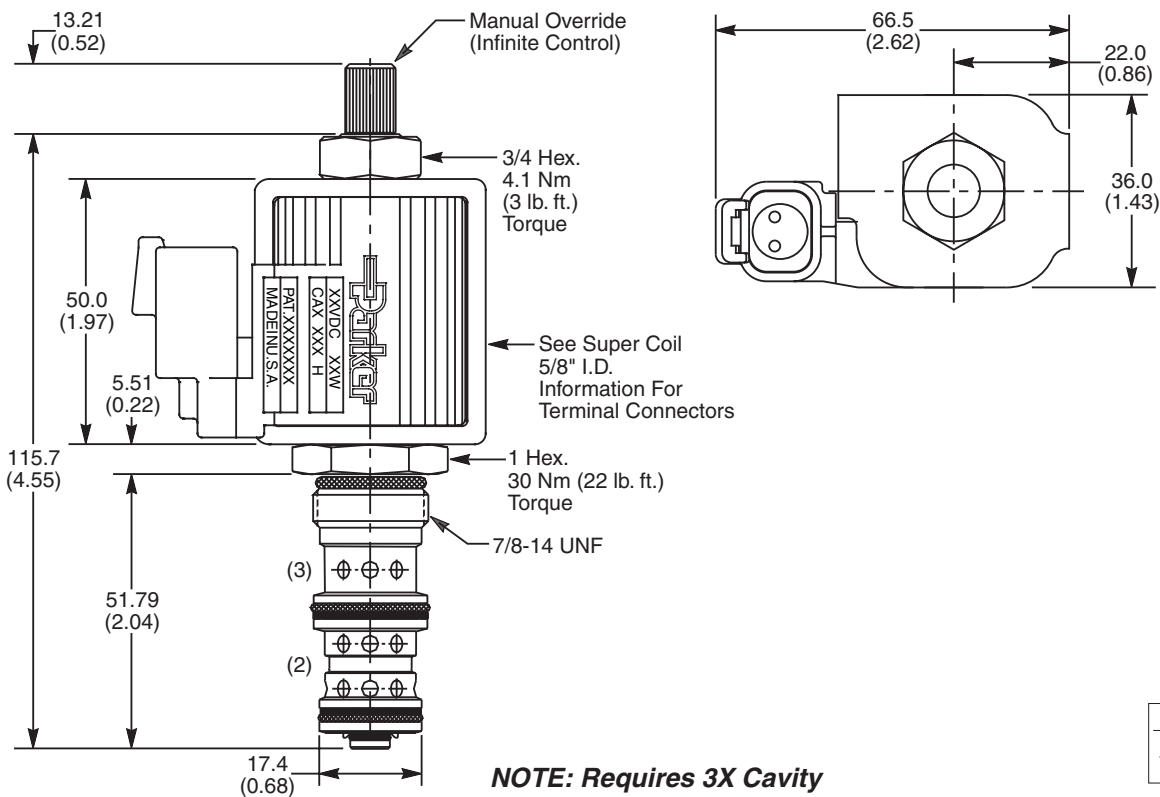

Ordering Information

JP04C **21**

10 Size Proportional Valve Style Override Option Filter Screen Seals Flow Variation Coil Type Coil Voltage Coil Termination

Code	Style (Maximum Regulated Flow)
21	Standard ('SS' Coil) 30 LPM (8 GPM)
21	High Flow ('SP' Coil) 36 LPM 9.5 GPM)

Code	Filter Screen
0	Not Required
1	60 Mesh Screen on Port 2

Code	Flow Variation
Omit	Standard Up to ±20% of Rated Flow
L	Low Variation (±7% of Rated Flow)

Code	Coil Voltage
Omit	Without Coil
D012	12 VDC
D024	24 VDC

Code	Override Option
0	Not Required
5	Detented M.O. (Infinite Control)

Code	Seals / Kit No.
N	Nitrile / Buna-N (Std.) (SK30106N-1)
V	Fluorocarbon / (SK30106V-1)

Code	Coil Type
Omit	Without Coil
SS	Super Coil - 18 Watts
SP	Super Coil - 28 Watts

Code	Coil Termination
Omit	Without Coil
D	DIN Plug Face
A	Amp Jr. Timer*
L	Dual Lead Wire*
LS	Sealed Lead Wire*
H	Molded Deutsch*

See Super Coil 5/8" I.D.
 *DC Only

Order Bodies Separately

LB10

Line Body Porting Body Material

Code	Porting
553	1/2" SAE
554	3/8" BSP

Code	Body Material
A	Aluminum
S	Steel



- CV**
- Check Valves
- SH**
- Shuttle Valves
- LM**
- Load/Motor Controls
- FC**
- Flow Controls
- PC**
- Pressure Controls
- LE**
- Logic Elements
- DC**
- Directional Controls
- MV**
- Manual Valves
- SV**
- Solenoid Valves
- PV**
- Proportional Valves
- CE**
- Coils & Electronics
- BC**
- Bodies & Cavities
- TD**
- Technical Data

Technical Information

- CV** Check Valves
- SH** Shuttle Valves
- LM** Load/Motor Controls
- FC** Flow Controls
- PC** Pressure Controls
- LE** Logic Elements
- DC** Directional Controls
- MV** Manual Valves
- SV** Solenoid Valves
- PV** Proportional Valves
- CE** Coils & Electronics
- BC** Bodies & Cavities
- TD** Technical Data

General Description

2 Way, Normally Closed, Proportional Flow Regulator Valve. Pressure Compensated. For additional information see Technical Tips on pages PV1-PV6.

Features

- One piece cartridge housing ensures internal concentricity
- Coil: Waterproof, hermetically sealed, requires no O'Rings; Symmetrical coil can be reversed without affecting performance.

NOTE:

This valve will be available January 1, 2011.

Specifications

Rated Flow @ 75% of Rated Current	56.8 LPM (15 GPM) Requires ('SP' Coil)
Maximum Input Pressure At Port 2	210 Bar (3000 PSI)
Minimum Pressure Differential	20.7 Bar (300 PSI)
Maximum Internal Leakage	568 cc (35 cu. in.) @ 210 Bar (3000 PSI)
Hysteresis @ 100 Hz PWM	>15%
Cartridge Material	All parts steel. All operating parts hardened steel.
Operating Temp. Range/Seals	-40°C to +93.3°C (Nitrile) (-40°F to +200°F) -31.7°C to +121.1°C (Fluorocarbon) (-25°F to +250°F)
Fluid Compatibility/ Viscosity	Mineral-based or synthetic with lubricating properties at viscosities of 45 to 2000 SSU (6 to 420 cSt)
Filtration	ISO Code 16/13, SAE Class 4 or better
Approx. Weight	.40 kg (.89 lbs.)
Cavity	C12-3L (See BC Section for more details)

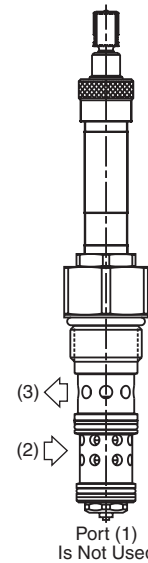
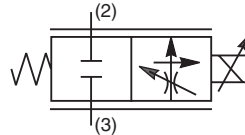

Performance Curves

▲ PWM Current Regulator Recommended

Pressure Compensation of Regulated Flow

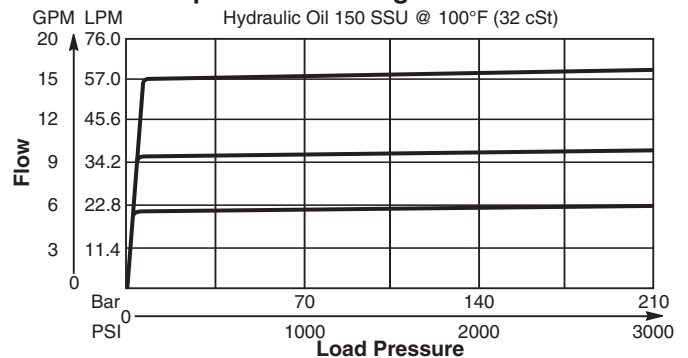

Flow vs. Input Current

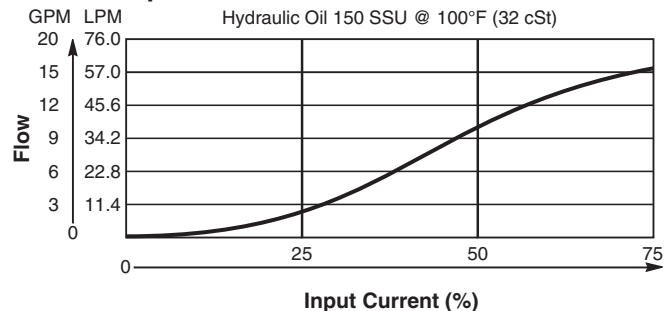

Pressure Drop vs. Flow (Through cartridge only)

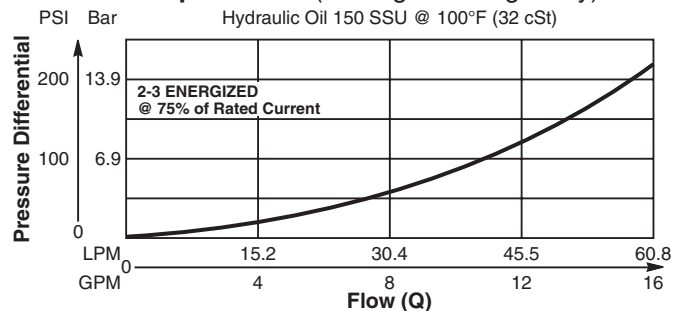

Dimensions Millimeters (Inches)

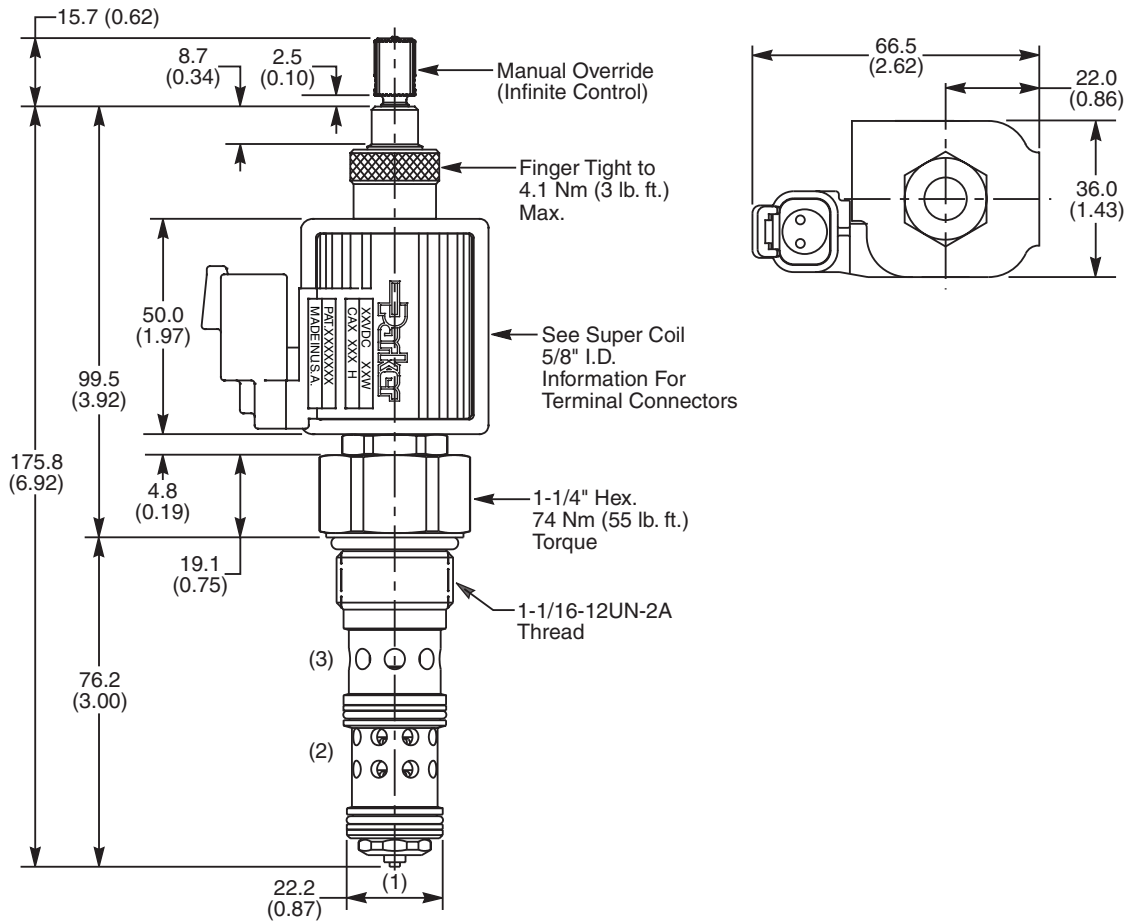

Ordering Information

DFA125C **21** **S**

12 Size Proportional Valve Style Override Option Seals Coil Type Coil Voltage Coil Termination

NOTE:
 This valve will be available
 January 1, 2011.

Code	Style (Maximum Regulated Flow)
21	High Flow ("SP" Coil) 56.8 LPM (15 GPM)

Code	Seals / Kit No.
N	Nitrile / Buna-N (Std.) (SK12-3LN)
V	Fluorocarbon / (SK12-3LV)

Code	Coil Type
Omit	Without Coil
SP	Super Coil - 28 Watts

Code	Coil Termination
Omit	Without Coil
D	DIN Plug Face
A	Amp Jr. Timer*
S	Dual Spade*
L	Dual Lead Wire*
LS	Sealed Lead Wire*
H	Molded Deutsch*

Code	Override Option
Omit	Not Available
S	Standard M.O. (Infinite Control)

Code	Coil Voltage
Omit	Without Coil
D012	12 VDC
D024	24 VDC

See Super Coil 5/8" I.D.
 *DC Only

Order Bodies Separately

B12 — **3L** — **A** **12T**

12 Size 3-Way Long Cavity Body Material Port Size

Code	Body Material
A	Aluminum

Code	Port Size
12T	SAE - 12



- CV** Check Valves
- SH** Shuttle Valves
- LM** Load/Motor Controls
- FC** Flow Controls
- PC** Pressure Controls
- LE** Logic Elements
- DC** Directional Controls
- MV** Manual Valves
- SV** Solenoid Valves
- PV** Proportional Valves
- CE** Coils & Electronics
- BC** Bodies & Cavities
- TD** Technical Data

Technical Information

- CV** Check Valves
- SH** Shuttle Valves
- LM** Load/Motor Controls
- FC** Flow Controls
- PC** Pressure Controls
- LE** Logic Elements
- DC** Directional Controls
- MV** Manual Valves
- SV** Solenoid Valves
- PV** Proportional Valves
- CE** Coils & Electronics
- BC** Bodies & Cavities
- TD** Technical Data

General Description

2 Way, Normally Open, Proportional Flow Regulator Valve. Partially Pressure Compensated. For additional information see Technical Tips on pages PV1-PV6.

Features

- Analog Proportional Partially Pressure Compensated Flow Regulator regulates flow proportionally to the input solenoid current
- The valve is designed to be used in applications where fine pressure compensation is not required and an economical solution is important
- One piece cartridge housing ensures internal concentricity
- Coil: Waterproof, hermetically sealed, requires no O’Rings; Symmetrical coil can be reversed without affecting performance.
- Nonmagnetic spool and housing assembly
- Factory-adjusted low variation option (Model “L”) is available for applications where low variation of flow from valve to valve is essential at a given current or when an external pressure compensator is used.

Specifications

Rated Flow @ 210 Bar (3000 PSI)	2 to 1 19 LPM (5 GPM)
Preferable Input Port For Best Hysteresis	Port 1
Hysteresis @ 100 Hz PWM	<10%
Variation of Flow @ 35% of Rated Current & Constant ΔP Maintained By Pressure Compensator	Standard Model Up To ±20% Of Rated Flow Model “L” ±7% Of Rated Flow
Cartridge Material	All parts steel. All operating parts hardened steel.
Operating Temp. Range/Seals	-40°C to +93.3°C (Nitrile) (-40°F to +200°F) -31.7°C to +121.1°C (Fluorocarbon) (-25°F to +250°F)
Fluid Compatibility/ Viscosity	Mineral-based or synthetic with lubricating properties at viscosities of 45 to 2000 SSU (6 to 420 cSt)
Filtration	ISO Code 16/13, SAE Class 4 or better
Approx. Weight	.08 kg (.17 lbs.)
Cavity	2X (See BC Section for more details)

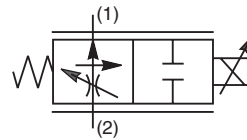
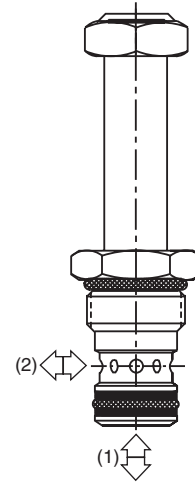
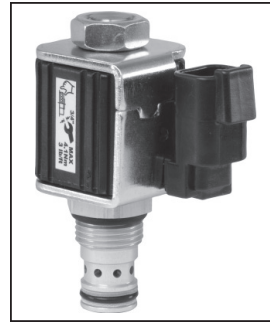

Performance Curves

▲ PWM Current Regulator Recommended

Flow vs. Input Current

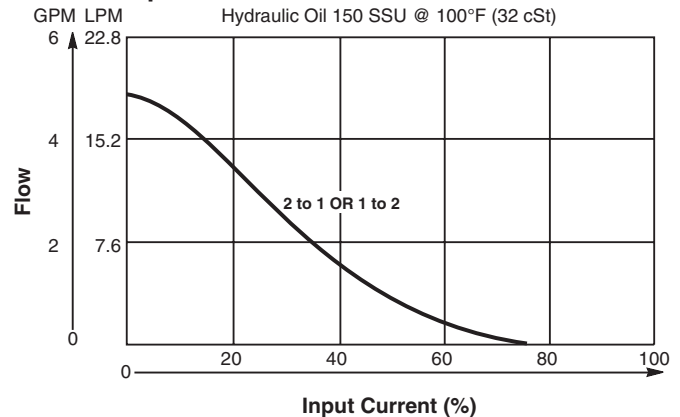

Flow Regulation (Measured at De-Energized Coil)

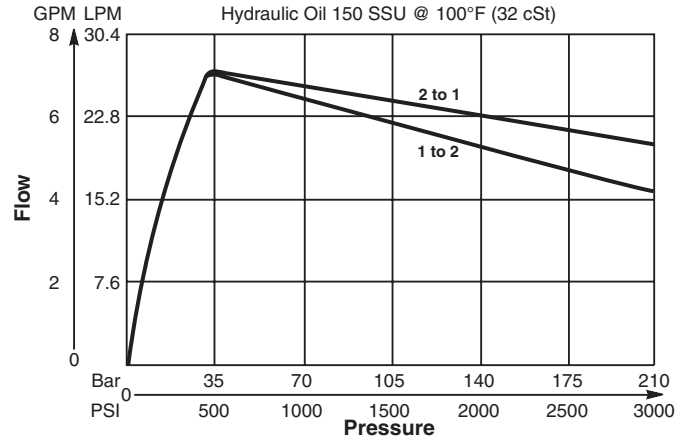

Dimensions Millimeters (Inches)

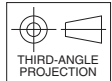
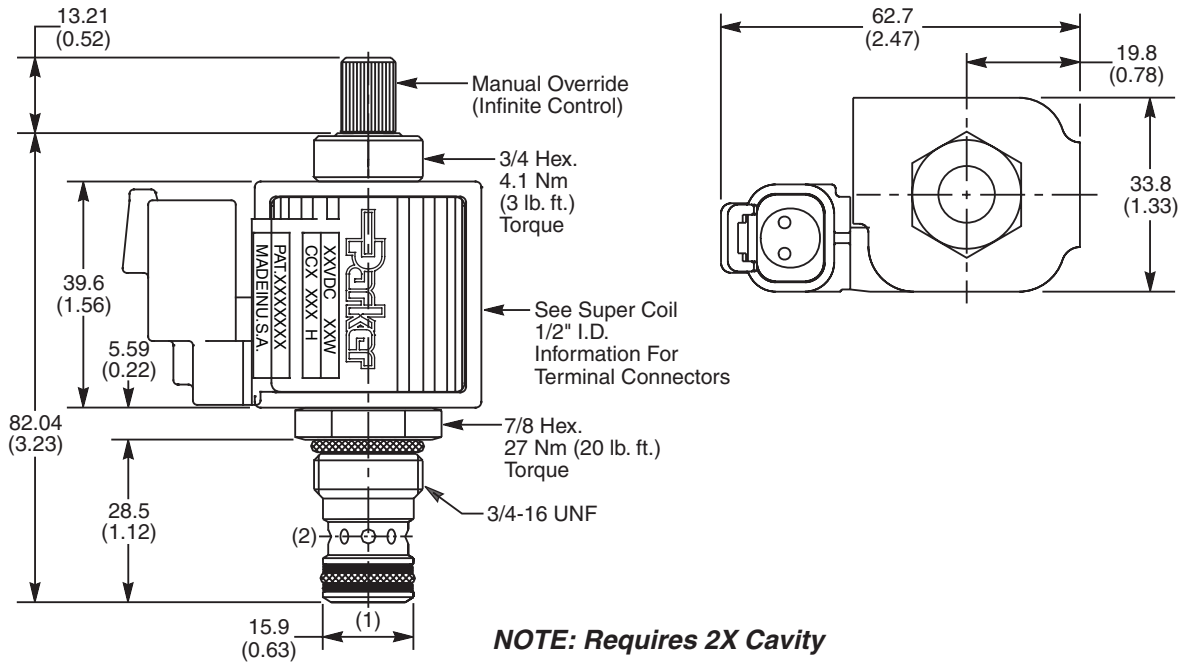

Ordering Information

HP02P	21							
08 Size Proportional Valve	Style	Override Option	Filter Screen	Seals	Flow Variation	Coil Type	Coil Voltage	Coil Termination

Code	Style (Maximum Regulated Flow)
21	High Flow ('SP' Coil) 19 LPM (5 GPM)

Code	Filter Screen
0	Not Available

Code	Flow Variation
Omit	Standard Up to ±20% of Rated Flow
L	Low Variation (±7% of Rated Flow)

Code	Coil Voltage
Omit	Without Coil
D012	12 VDC
D024	24 VDC

Code	Override Option
0	Not Required
5	Detented M.O. (Infinite Control)

Code	Seals / Kit No.
N	Nitrile / Buna-N (Std.) (SK30076N-1)
V	Fluorocarbon / (SK30076V-1)

Code	Coil Type
Omit	Without Coil
SP	Super Coil - 19 Watts

Code	Coil Termination
Omit	Without Coil
D	DIN Plug Face
A	Amp Jr. Timer*
L	Dual Lead Wire*
LS	Sealed Lead Wire*
H	Molded Deutsch*

See Super Coil 1/2" I.D.
*DC Only

Order Bodies Separately

LB10		
Line Body	Porting	Body Material

Code	Porting
513	3/8" SAE
515	1/4" BSP

Code	Body Material
A	Aluminum
S	Steel



- CV**
Check Valves
- SH**
Shuttle Valves
- LM**
Load/Motor Controls
- FC**
Flow Controls
- PC**
Pressure Controls
- LE**
Logic Elements
- DC**
Directional Controls
- MV**
Manual Valves
- SV**
Solenoid Valves
- PV**
Proportional Valves
- CE**
Coils & Electronics
- BC**
Bodies & Cavities
- TD**
Technical Data

Technical Information

- CV** Check Valves
- SH** Shuttle Valves
- LM** Load/Motor Controls
- FC** Flow Controls
- PC** Pressure Controls
- LE** Logic Elements
- DC** Directional Controls
- MV** Manual Valves
- SV** Solenoid Valves
- PV** Proportional Valves
- CE** Coils & Electronics
- BC** Bodies & Cavities
- TD** Technical Data

General Description

2 Way, Normally Open, Proportional Flow Regulator Valve. Pressure Compensated. For additional information see Technical Tips on pages PV1-PV6.

Features

- One piece cartridge housing ensures internal concentricity
- Coil: Waterproof, hermetically sealed, requires no O’Rings; Symmetrical coil can be reversed without affecting performance.
- Nonmagnetic spool and housing assembly
- Factory-adjusted low variation option (Model “L”) is available for applications where low variation of flow from valve to valve is essential at a given current.

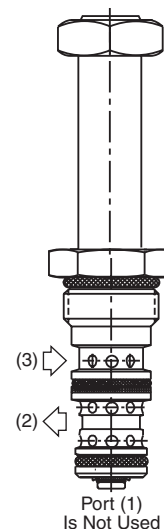
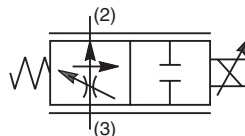
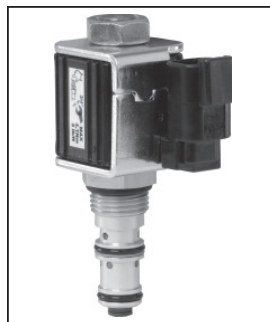

Specifications

Rated Flow	20	9.5 LPM (2.5 GPM) Standard (‘SS’ Coil)
	21	19 LPM (5 GPM) High Flow (‘SP’ Coil)
Maximum Input Pressure At Port 2	210 Bar (3000 PSI)	
Minimum Pressure Differential	20	6.9 Bar (150 PSI) Standard
	21	20.7 Bar (300 PSI) High Flow
Maximum Internal Leakage	570 cc (35 cu. in.) @ 210 Bar (3000 PSI)	
Hysteresis @ 100 Hz PWM	<3%	
Variation of Flow @ 35% of Rated Current	Standard Model Up To ±20% Of Rated Flow Model “L” ±7% Of Rated Flow	
Cartridge Material	All parts steel. All operating parts hardened steel.	
Operating Temp. Range/Seals	-40°C to +93.3°C (Nitrile) (-40°F to +200°F) -31.7°C to +121.1°C (Fluorocarbon) (-25°F to +250°F)	
Fluid Compatibility/ Viscosity	Mineral-based or synthetic with lubricating properties at viscosities of 45 to 2000 SSU (6 to 420 cSt)	
Filtration	ISO Code 16/13, SAE Class 4 or better	
Approx. Weight	.08 kg (.17 lbs.)	
Cavity	C08-3 (See BC Section for more details)	

Performance Curves

▲ PWM Current Regulator Recommended

Flow vs. Input Current

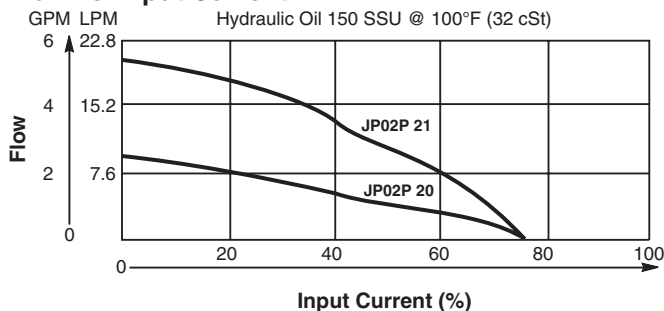

Flow Regulation (Measured 75% of Rated Current)

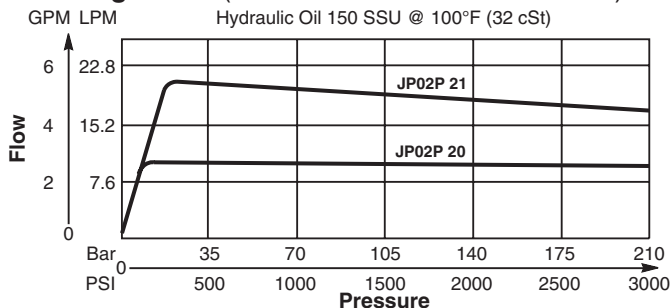

Pressure Drop vs. Flow

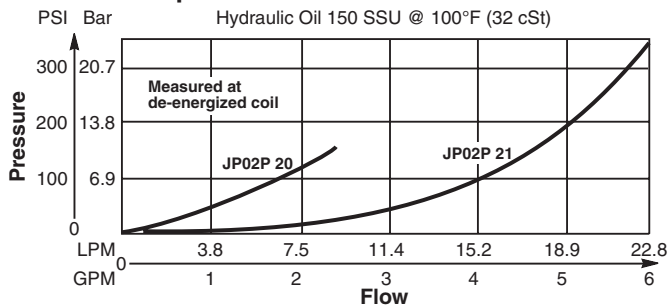

Dimensions Millimeters (Inches)

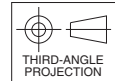
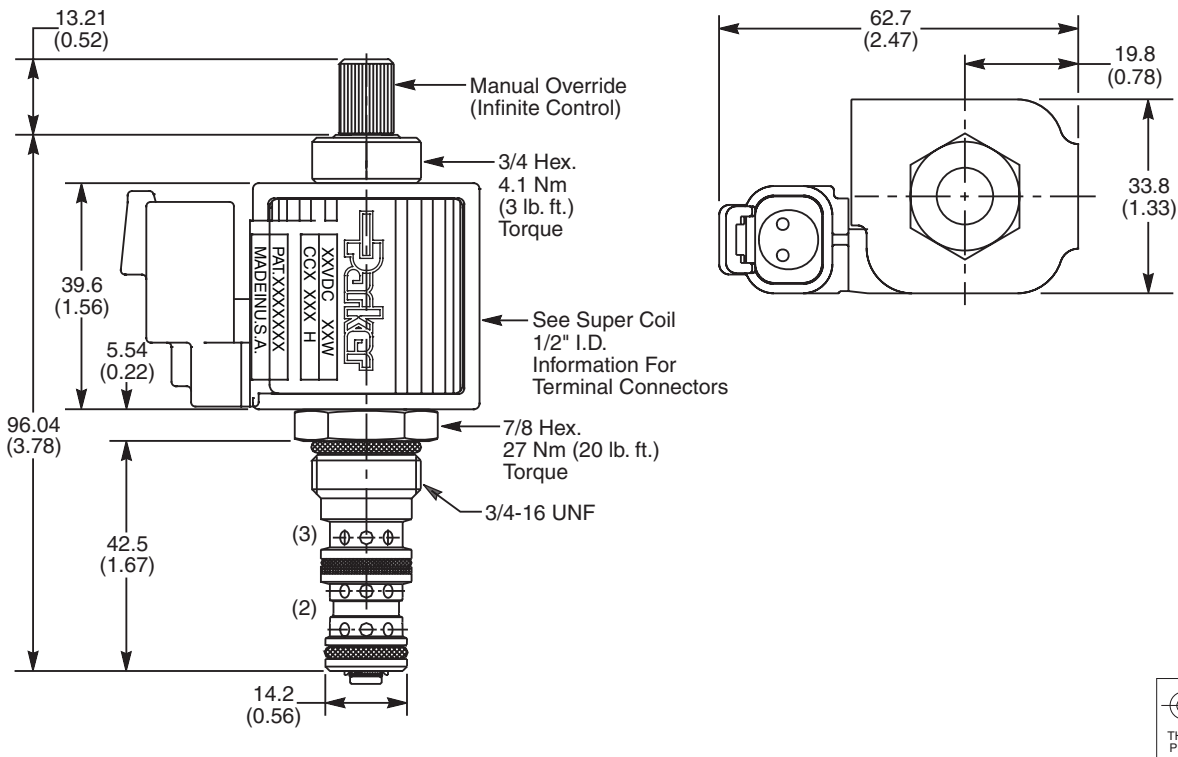

Ordering Information

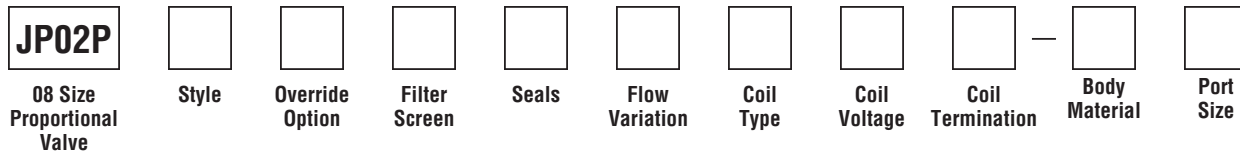

Code	Style (Maximum Regulated Flow)
20	Standard ('SS' Coil) 9.5 LPM (2.5 GPM)
21	High Flow ('SP' Coil) 19 LPM (5 GPM)

Code	Seals / Kit No.
N	Nitrile / Buna-N (Std.) (SK30105N-1)
V	Fluorocarbon / (SK30105V-1)

Code	Coil Voltage
Omit	Without Coil
D012	12 VDC
D024	24 VDC

Code	Body Material
Omit	Steel
A	Aluminum

Code	Override Option
0	Not Required
5	Detented M.O. (Infinite Control)

Code	Flow Variation
Omit	Standard Up to ±20% of Rated Flow
L	Low Variation (±7% of Rated Flow)

Code	Coil Termination
Omit	Without Coil
D	DIN Plug Face
A	Amp Jr. Timer*
L	Dual Lead Wire*
LS	Sealed Lead Wire*
H	Molded Deutsch*

Code	Port Size	Body Part No.
Omit	Cartridge Only	
4P	1/4" NPTF	(B08-3-*4P)
4T	SAE-4	(B08-3-*4T)
6T	SAE-6	(B08-3-*6T)
6B	3/8" BSPG	(B08-3-*6B)

* Add "A" for aluminum, omit for steel.

Code	Filter Screen
0	Not Required
1	60 Mesh Screen on Port 2

Code	Coil Type
Omit	Without Coil
SS	Super Coil - 14 Watts
SP	Super Coil - 19 Watts

See Super Coil 1/2" I.D.
 *DC Only

- CV
- Check Valves
- SH
- Shuttle Valves
- LM
- Load/Motor Controls
- FC
- Flow Controls
- PC
- Pressure Controls
- LE
- Logic Elements
- DC
- Directional Controls
- MV
- Manual Valves
- SV
- Solenoid Valves
- PV
- Proportional Valves
- CE
- Coils & Electronics
- BC
- Bodies & Cavities
- TD
- Technical Data

Technical Information

- CV** Check Valves
- SH** Shuttle Valves
- LM** Load/Motor Controls
- FC** Flow Controls
- PC** Pressure Controls
- LE** Logic Elements
- DC** Directional Controls
- MV** Manual Valves
- SV** Solenoid Valves
- PV** Proportional Valves
- CE** Coils & Electronics
- BC** Bodies & Cavities
- TD** Technical Data

General Description

2 Way, Normally Open, Proportional Flow Regulator Valve. Partially Pressure Compensated. For additional information see Technical Tips on pages PV1-PV6.

Features

- Analog Proportional Partially Pressure Compensated Flow Regulator regulates flow proportionally to the input solenoid current
- The valve is designed to be used in applications where fine pressure compensation is not required and an economical solution is important
- One piece cartridge housing ensures internal concentricity
- Coil: Waterproof, hermetically sealed, requires no O’Rings; Symmetrical coil can be reversed without affecting performance.
- Nonmagnetic spool and housing assembly
- Factory-adjusted low variation option (Model “L”) is available for applications where low variation of flow from valve to valve is essential at a given current or when an external pressure compensator is used.

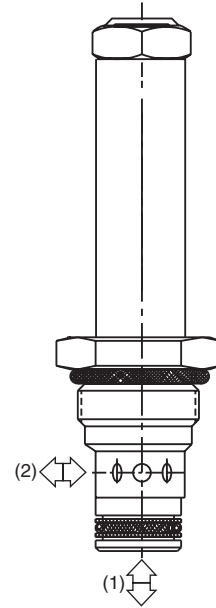
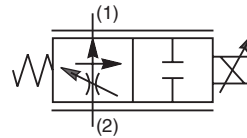

Specifications

Rated Flow @ 210 Bar (3000 PSI)	23 LPM (6 GPM)
Hysteresis @ 100 Hz PWM	<10%
Closing Point	65% of Rated Current
Variation of Closing Point	Standard Model Up To ±5% Of Rated Current Model “L” ±2% Of Rated Current
Cartridge Material	All parts steel. All operating parts hardened steel.
Operating Temp. Range/Seals	-40°C to +93.3°C (Nitrile) (-40°F to +200°F) -31.7°C to +121.1°C (Fluorocarbon) (-25°F to +250°F)
Fluid Compatibility/ Viscosity	Mineral-based or synthetic with lubricating properties at viscosities of 45 to 2000 SSU (6 to 420 cSt)
Filtration	ISO Code 16/13, SAE Class 4 or better
Approx. Weight	.12 kg (.26 lbs.)
Cavity	C10-2 (See BC Section for more details)

Performance Curves

▲ PWM Current Regulator Recommended

Flow vs. Input Current

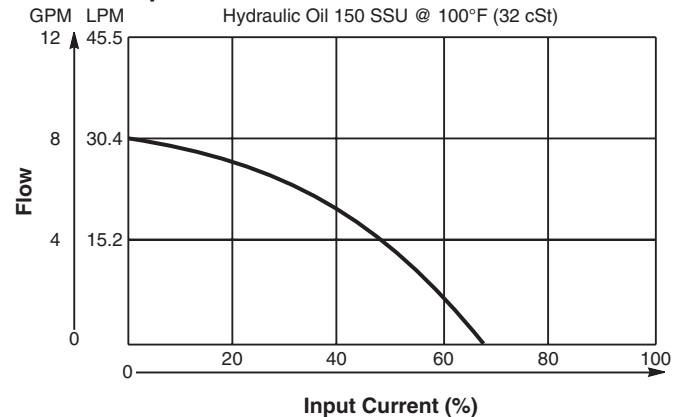

Flow Regulation

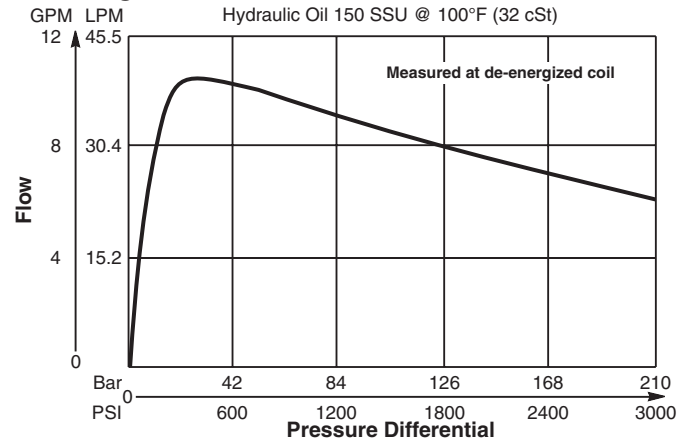

Dimensions Millimeters (Inches)

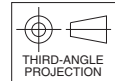
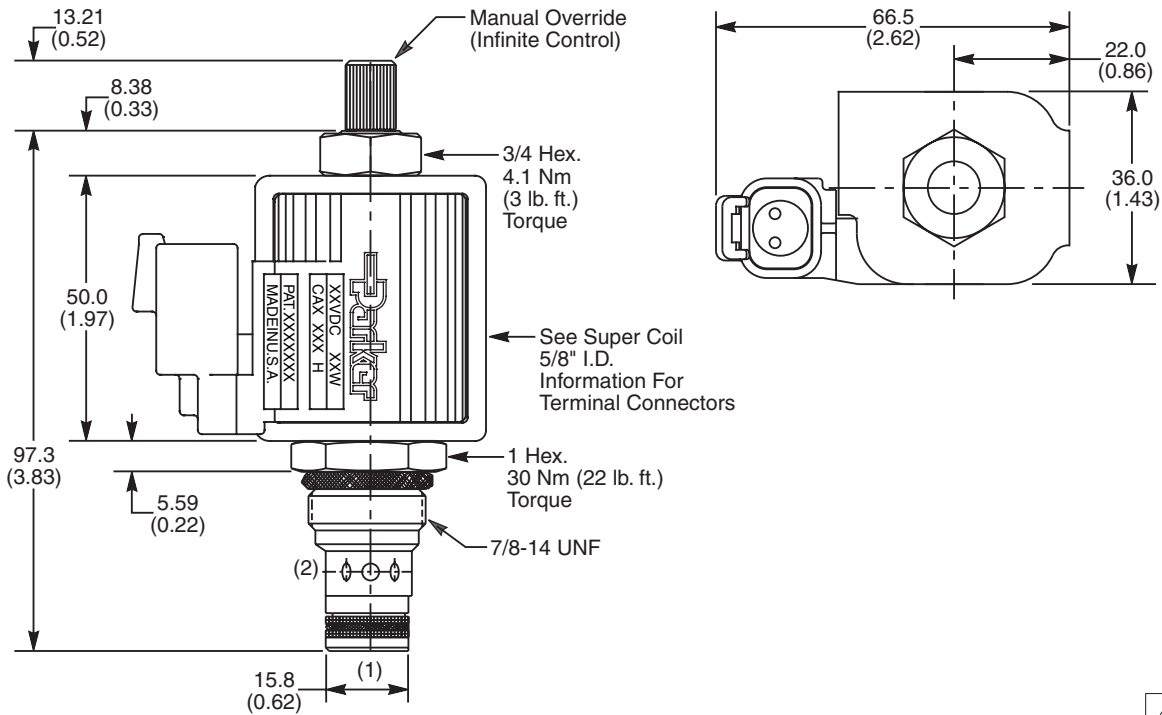

Ordering Information

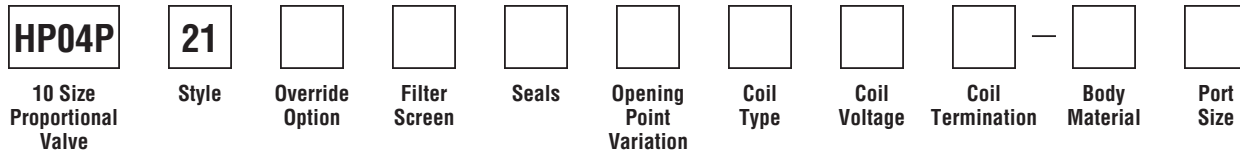

Code	Style (Maximum Regulated Flow)
21	High Flow ("SP" Coil) 30 LPM (8 GPM)

Code	Seals / Kit No.
N	Nitrile / Buna-N (Std.) (SK30503N-1)
V	Fluorocarbon / (SK30503V-1)

Code	Coil Voltage
Omit	Without Coil
D012	12 VDC
D024	24 VDC

Code	Body Material
Omit	Steel
A	Aluminum

Code	Override Option
0	Not Required
5	Detented M.O. (Infinite Control)

Code	Flow Variation
Omit	Standard Up to ±5% of Current Flow
L	Low Variation (±2% of Current Flow)

Code	Coil Termination
Omit	Without Coil
D	DIN Plug Face
A	Amp Jr. Timer*
L	Dual Lead Wire*
LS	Sealed Lead Wire*
H	Molded Deutsch*

Code	Port Size	Body Part No.
Omit	Cartridge Only	
4P	1/4" NPTF	(B10-2-*4P)
6P	3/8" NPTF	(B10-2-*6P)
8P	1/2" NPTF	(B10-2-*8P)
6T	SAE-6	(B10-2-*6T)
8T	SAE-8	(B10-2-*8T)
T8T	SAE-8	(B10-2-T8T)†
6B	3/8" BSPG	(B10-2-*6B)

Code	Filter Screen
0	Not Available

Code	Coil Type
Omit	Without Coil
SP	Super Coil - 28 Watts

See Super Coil 5/8" I.D.
*DC Only

* Add "A" for aluminum, omit for steel.
† Steel body only.



- CV
Check Valves
- SH
Shuttle Valves
- LM
Load/Motor Controls
- FC
Flow Controls
- PC
Pressure Controls
- LE
Logic Elements
- DC
Directional Controls
- MV
Manual Valves
- SV
Solenoid Valves
- PV
Proportional Valves
- CE
Coils & Electronics
- BC
Bodies & Cavities
- TD
Technical Data

Technical Information

- CV** Check Valves
- SH** Shuttle Valves
- LM** Load/Motor Controls
- FC** Flow Controls
- PC** Pressure Controls
- LE** Logic Elements
- DC** Directional Controls
- MV** Manual Valves
- SV** Solenoid Valves
- PV** Proportional Valves
- CE** Coils & Electronics
- BC** Bodies & Cavities
- TD** Technical Data

General Description

2 Way, Normally Open, Proportional Flow Regulator Valve. Pressure Compensated. For additional information see Technical Tips on pages PV1-PV6.

Features

- One piece cartridge housing ensures internal concentricity
- Coil: Waterproof, hermetically sealed, requires no O’Rings; Symmetrical coil can be reversed without affecting performance.
- Nonmagnetic spool and housing assembly
- Factory-adjusted low variation option (Model “L”) is available for applications where low variation of flow from valve to valve is essential at a given current.

Specifications

Rated Flow	36 LPM (9.5 GPM) High Flow (‘SP’ Coil)
Maximum Input Pressure At Port 2	210 Bar (3000 PSI)
Minimum Pressure Differential	14 Bar (200 PSI)
Maximum Internal Leakage	780 cc (46 cu. in.) @ 210 Bar (3000 PSI)
Hysteresis @ 100 Hz PWM	7%
Variation of Flow @ 35% of Rated Current	Standard Model Up To ±20% Of Rated Flow Model “L” ±7% Of Rated Flow
Cartridge Material	All parts steel. All operating parts hardened steel.
Operating Temp. Range/Seals	-40°C to +93.3°C (Nitrile) (-40°F to +200°F) -31.7°C to +121.1°C (Fluorocarbon) (-25°F to +250°F)
Fluid Compatibility/ Viscosity	Mineral-based or synthetic with lubricating properties at viscosities of 45 to 2000 SSU (6 to 420 cSt)
Filtration	ISO Code 16/13, SAE Class 4 or better
Approx. Weight	.13 kg (.28 lbs.)
Cavity	3X (See BC Section for more details)

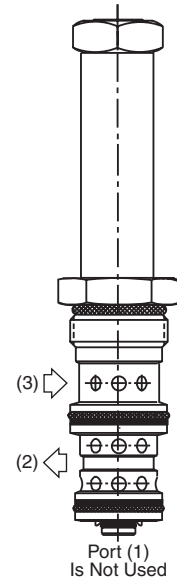
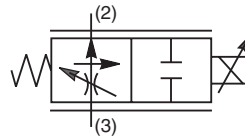

Performance Curves

▲ PWM Current Regulator Recommended

Flow vs. Input Current

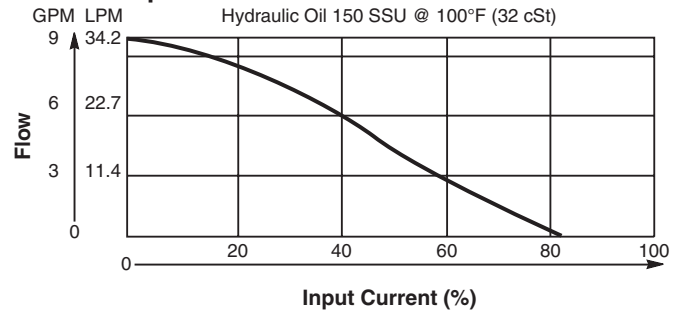

Flow Regulation

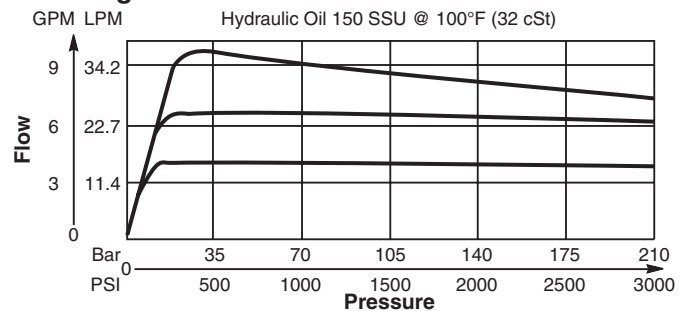

Pressure Drop vs. Flow

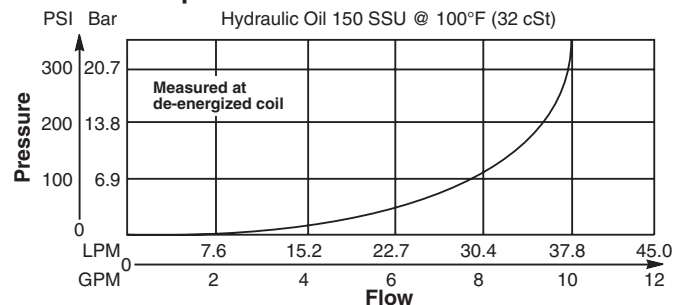

Dimensions Millimeters (Inches)

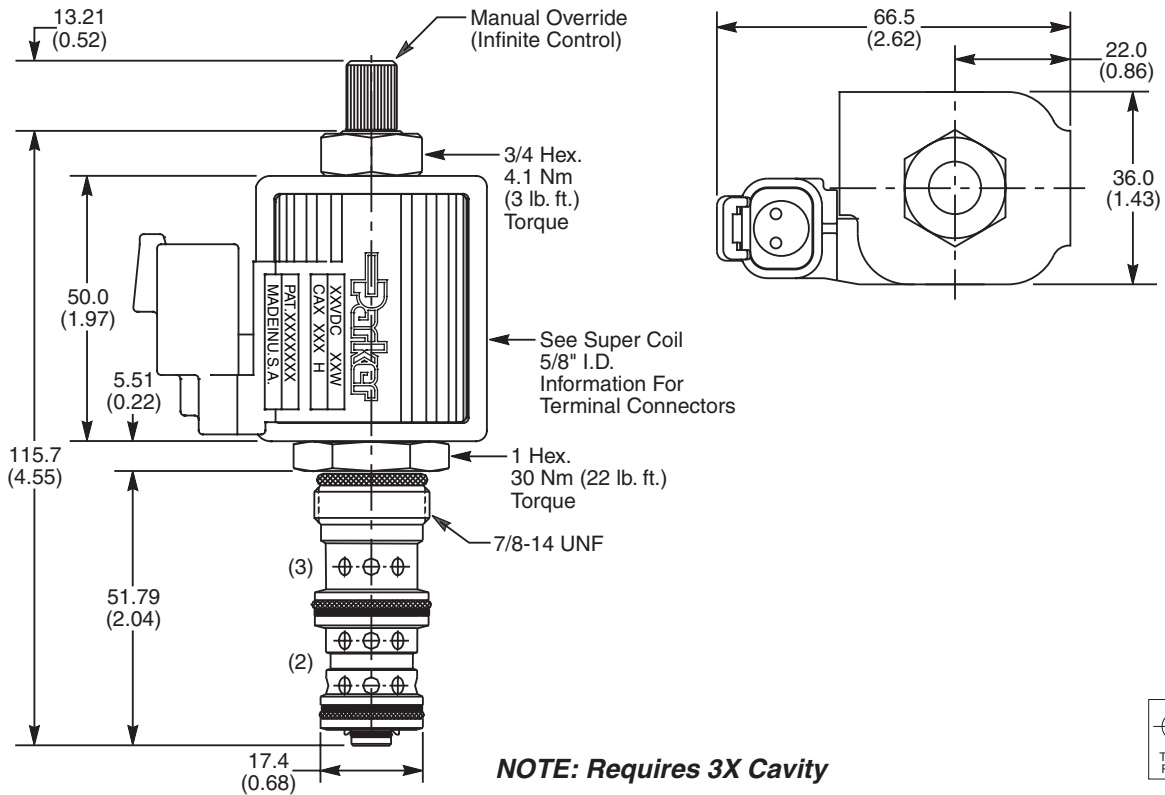

NOTE: Requires 3X Cavity

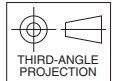

Ordering Information

JP04P	21							
10 Size Proportional Valve	Style	Override Option	Filter Screen	Seals	Flow Variation	Coil Type	Coil Voltage	Coil Termination

Code	Style (Maximum Regulated Flow)
21	High Flow ('SP' Coil) 36 LPM 9.5 GPM)

Code	Filter Screen
0	Not Required
1	60 Mesh Screen on Port 2

Code	Flow Variation
Omit	Standard Up to ±20% of Rated Flow
L	Low Variation (±7% of Rated Flow)

Code	Coil Voltage
Omit	Without Coil
D012	12 VDC
D024	24 VDC

Code	Override Option
0	Not Required
5	Detented M.O. (Infinite Control)

Code	Seals / Kit No.
N	Nitrile / Buna-N (Std.) (SK30106N-1)
V	Fluorocarbon / (SK30106V-1)

Code	Coil Type
Omit	Without Coil
SP	Super Coil - 28 Watts

Code	Coil Termination
Omit	Without Coil
D	DIN Plug Face
A	Amp Jr. Timer*
L	Dual Lead Wire*
LS	Sealed Lead Wire*
H	Molded Deutsch*

See Super Coil 5/8" I.D.
 *DC Only

Order Bodies Separately

LB10		
Line Body	Porting	Body Material

Code	Porting
553	1/2" SAE
554	3/8" BSP

Code	Body Material
A	Aluminum
S	Steel



- CV**
- Check Valves
- SH**
- Shuttle Valves
- LM**
- Load/Motor Controls
- FC**
- Flow Controls
- PC**
- Pressure Controls
- LE**
- Logic Elements
- DC**
- Directional Controls
- MV**
- Manual Valves
- SV**
- Solenoid Valves
- PV**
- Proportional Valves
- CE**
- Coils & Electronics
- BC**
- Bodies & Cavities
- TD**
- Technical Data

Technical Information

- CV** Check Valves
- SH** Shuttle Valves
- LM** Load/Motor Controls
- FC** Flow Controls
- PC** Pressure Controls
- LE** Logic Elements
- DC** Directional Controls
- MV** Manual Valves
- SV** Solenoid Valves
- PV** Proportional Valves
- CE** Coils & Electronics
- BC** Bodies & Cavities
- TD** Technical Data

General Description

Normally Open Proportional Flow Control Valve. For additional information see Technical Tips on pages PV1-PV6.

Features

- On-off type solenoids
- Low hysteresis
- PWM signal preferred
- Manual override standard
- All external parts zinc plated

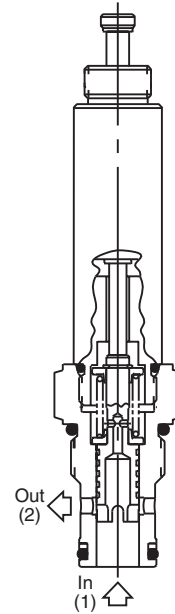
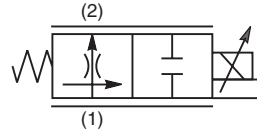
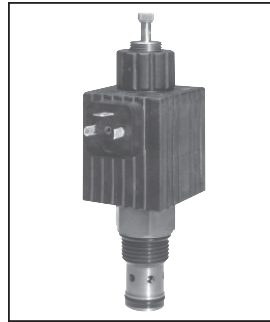

Specifications

Rated Flow Valve Fully Open	53 LPM (14 GPM)
Maximum Inlet Pressure	210 Bar (3000 PSI)
Hysteresis @ 200 Hz PWM	4%
Frequency	100 - 400 Hz (200 Hz Preferred)
Maximum Control Current	12 VDC 2.45A 24VDC 1.23A
Cartridge Material	All parts steel. All operating parts hardened steel.
Operating Temp. Range/Seals	-40°C to +93.3°C (Nitrile) (-40°F to +200°F) -31.7°C to +121.1°C (Fluorocarbon) (-25°F to +250°F)
Fluid Compatibility/Viscosity	Mineral-based or synthetic with lubricating properties at viscosities of 45 to 2000 SSU (6 to 420 cSt)
Filtration	ISO Code 16/13, SAE Class 4 or better
Approx. Weight	.32 kg (0.7 lbs.)
Cavity	C12-2 (See BC Section for more details)
Form Tool	Rougher None Finisher NFT12-2F

Note: 4.1 Bar (60psi) is required at port 1 to fully return Manual override.

Performance Curves

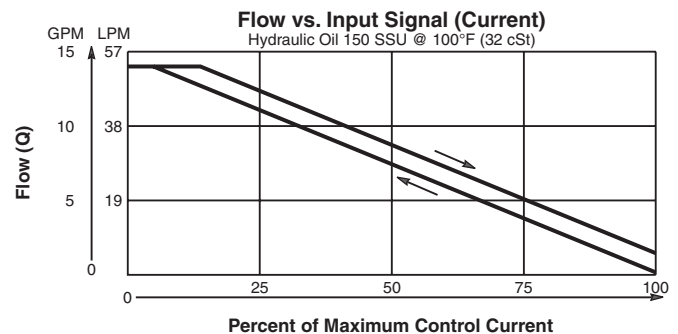
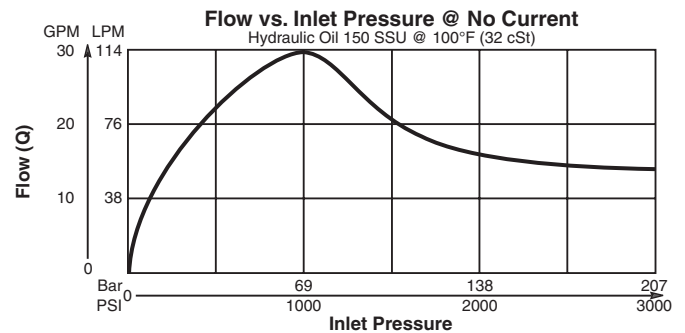
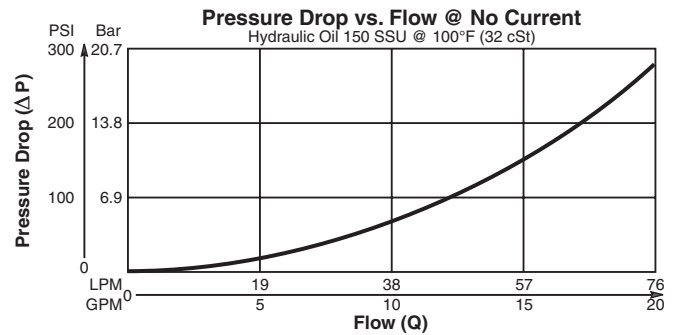

Technical Information

Dimensions Millimeters (Inches)

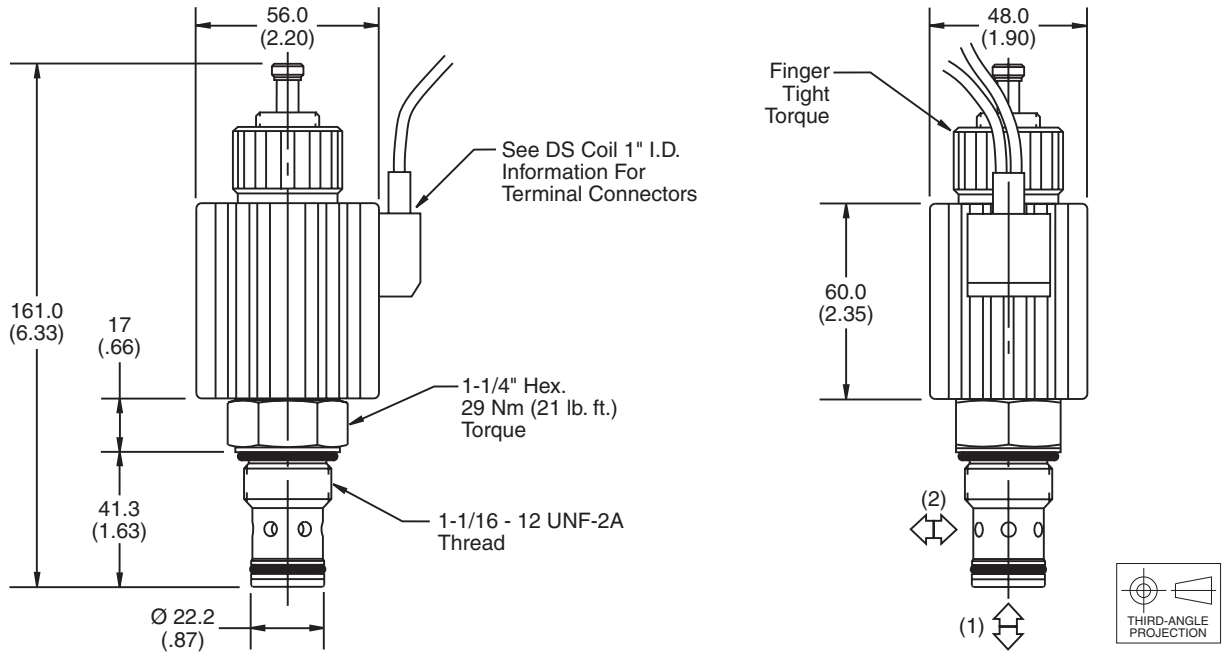

Ordering Information

DF122N14

12 Size Normally Open Proportional Flow Control Valve

Override Options Seals Coil Voltage Coil Wattage Coil Termination Body Material Port Size

Code	Override Options
Omit	Push Type with Extenden Rod

Code	Coil Voltage
Omit	Cartridge without Coil
D012	12 VDC
D024	24 VDC

Code	Coil Termination
Omit	Cartridge without Coil
D	DIN
P	Dual Spade
W	Dual Wire

Code	Body Material
Omit	Steel
A	Aluminum

Code	Seals / Kit. No.
Omit	Nitrile / (SK12-2)
V	Fluorocarbon / (SK12-2V)

Code	Coil Wattage
Omit	Cartridge without Coil
H	High Watt

See DS Coil 1" I.D.

Code	Port Size	Body Part No.
12P	3/4" NTPF	(B12-2-*12P)
8T	SAE - 8	(B12-2-*8T)
12T	SAE - 12	(B12-2-*12T)

* Add "A" for aluminum, omit for steel.

- CV
- Check Valves
- SH
- Shuttle Valves
- LM
- Load/Motor Controls
- FC
- Flow Controls
- PC
- Pressure Controls
- LE
- Logic Elements
- DC
- Directional Controls
- MV
- Manual Valves
- SV
- Solenoid Valves
- PV
- Proportional Valves
- CE
- Coils & Electronics
- BC
- Bodies & Cavities
- TD
- Technical Data

Technical Information

- CV** Check Valves
- SH** Shuttle Valves
- LM** Load/Motor Controls
- FC** Flow Controls
- PC** Pressure Controls
- LE** Logic Elements
- DC** Directional Controls
- MV** Manual Valves
- SV** Solenoid Valves
- PV** Proportional Valves
- CE** Coils & Electronics
- BC** Bodies & Cavities
- TD** Technical Data

General Description

3 Way, Normally Closed, Proportional Flow Regulator Valve. Pressure Compensated. For additional information see Technical Tips on pages PV1-PV6.

Features

- Analog proportional pressure compensated flow control valve regulates flow proportionally to the input solenoid current
- One piece cartridge housing ensures internal concentricity
- Coil: Waterproof, hermetically sealed, requires no O’Rings; Symmetrical coil can be reversed without affecting performance.
- Nonmagnetic spool and housing assembly
- Factory-adjusted low variation option (Model “L”) is available for applications where low variation of flow from valve to valve is essential at a given current.

Specifications

Rated Inlet Flow	60 LPM (16 GPM)				
Rated Regulated Flow	<table style="border: none;"> <tr> <td style="padding-right: 10px;">31</td> <td>26 LPM (7 GPM) Standard (‘SS’ Coil)</td> </tr> <tr> <td style="padding-right: 10px;">31</td> <td>30 LPM (8 GPM) High Flow (‘SP’ Coil)</td> </tr> </table>	31	26 LPM (7 GPM) Standard (‘SS’ Coil)	31	30 LPM (8 GPM) High Flow (‘SP’ Coil)
31	26 LPM (7 GPM) Standard (‘SS’ Coil)				
31	30 LPM (8 GPM) High Flow (‘SP’ Coil)				
Maximum Input Pressure At Port 3	210 Bar (3000 PSI)				
Minimum Pressure Differential	<table style="border: none;"> <tr> <td style="padding-right: 10px;">31</td> <td>13.8 Bar (200 PSI) Standard</td> </tr> <tr> <td style="padding-right: 10px;">31</td> <td>20.7 Bar (300 PSI) High Flow</td> </tr> </table>	31	13.8 Bar (200 PSI) Standard	31	20.7 Bar (300 PSI) High Flow
31	13.8 Bar (200 PSI) Standard				
31	20.7 Bar (300 PSI) High Flow				
Maximum Internal Leakage	780 cc (46 cu. in.) @ 210 Bar (3000 PSI)				
Hysteresis @ 100 Hz PWM	7%				
Opening Point	<table style="border: none;"> <tr> <td>Standard</td> <td>21% of Nominal Amperage</td> </tr> <tr> <td>High Flow</td> <td>17% of Nominal Amperage</td> </tr> </table>	Standard	21% of Nominal Amperage	High Flow	17% of Nominal Amperage
Standard	21% of Nominal Amperage				
High Flow	17% of Nominal Amperage				
Variation of Opening Point	<table style="border: none;"> <tr> <td>Standard Model</td> <td>Up To ±50% Of Amperage</td> </tr> <tr> <td>Model “L”</td> <td>±20% Of Amperage</td> </tr> </table>	Standard Model	Up To ±50% Of Amperage	Model “L”	±20% Of Amperage
Standard Model	Up To ±50% Of Amperage				
Model “L”	±20% Of Amperage				
Cartridge Material	All parts steel. All operating parts hardened steel.				
Operating Temp. Range/Seals	<table style="border: none;"> <tr> <td>-40°C to +93.3°C (Nitrile)</td> <td>(-40°F to +200°F)</td> </tr> <tr> <td>-31.7°C to +121.1°C (Fluorocarbon)</td> <td>(-25°F to +250°F)</td> </tr> </table>	-40°C to +93.3°C (Nitrile)	(-40°F to +200°F)	-31.7°C to +121.1°C (Fluorocarbon)	(-25°F to +250°F)
-40°C to +93.3°C (Nitrile)	(-40°F to +200°F)				
-31.7°C to +121.1°C (Fluorocarbon)	(-25°F to +250°F)				
Fluid Compatibility/ Viscosity	Mineral-based or synthetic with lubricating properties at viscosities of 45 to 2000 SSU (6 to 420 cSt)				
Filtration	ISO Code 16/13, SAE Class 4 or better				
Approx. Weight	.14 kg (.31 lbs.)				
Cavity	4C (See BC Section for more details)				

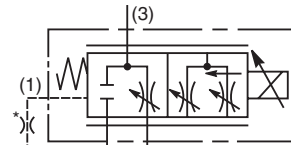

*Always connect Port (1) to Port (4) through .039" orifice.

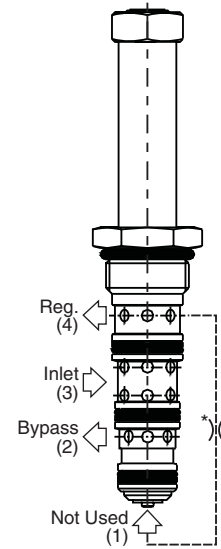

Performance Curves

▲ PWM Current Regulator Recommended

Pressure Compensation of Regulated Flow (Port 4)

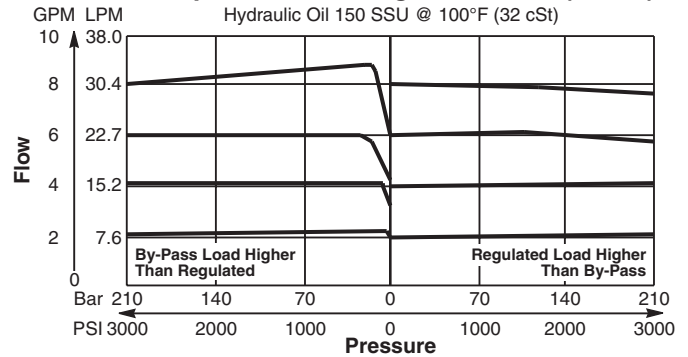

Regulated Flow vs. Input Current Stabilized

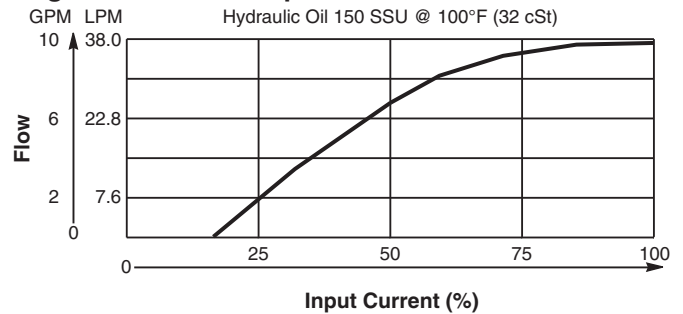

Pressure Drop vs. Flow at Coil Fully Energized

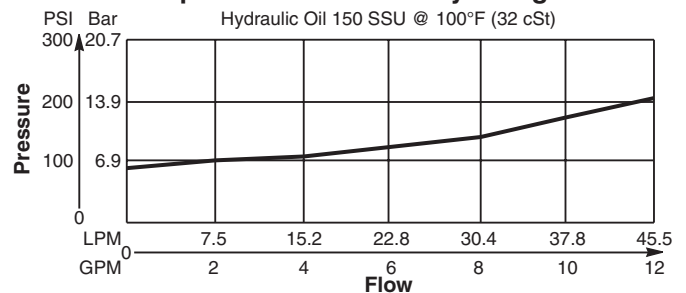

Dimensions Millimeters (Inches)

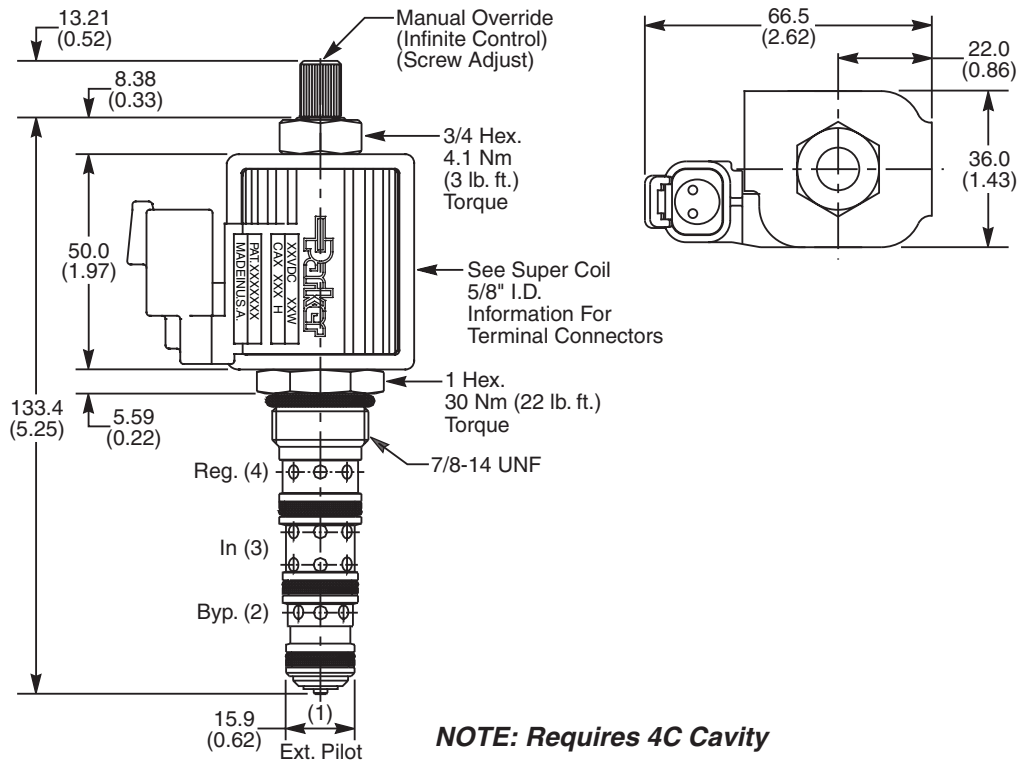

NOTE: Requires 4C Cavity

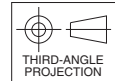

Ordering Information

JP04C	31							
10 Size Proportional Valve	Style	Override Option	Filter Screen	Seals	Flow Variation	Coil Type	Coil Voltage	Coil Termination

Code	Style (Maximum Regulated Flow)
31	Standard ('SS' Coil) 26 LPM (7 GPM)
31	High Flow ('SP' Coil) 30 LPM (8 GPM)

Code	Filter Screen
0	Not Available

Code	Seals / Kit No.
N	Nitrile / Buna-N (Std.) (SK30082N-1)
V	Fluorocarbon / (SK30082V-1)

Code	Flow Variation
Omit	Standard Up to ±50% of Opening Amps
L	Low Variation (±20% of Opening Amps)

Code	Coil Voltage
Omit	Without Coil
D012	12 VDC
D024	24 VDC

Code	Override Option
0	Not Required
5	Screw Adjust

Code	Coil Type
Omit	Without Coil
SS	Super Coil - 18 Watts
SP	Super Coil - 28 Watts

Code	Coil Termination
Omit	Without Coil
D	DIN Plug Face
A	Amp Jr. Timer*
L	Dual Lead Wire*
LS	Sealed Lead Wire*
H	Molded Deutsch*

See Super Coil 5/8" I.D.
 *DC Only

Order Bodies Separately

LB10		
Line Body	Porting	Body Material

Code	Porting
562	1/2" SAE
563	3/8" BSP

Code	Body Material
A	Aluminum
S	Steel



- CV**
- Check Valves
- SH**
- Shuttle Valves
- LM**
- Load/Motor Controls
- FC**
- Flow Controls
- PC**
- Pressure Controls
- LE**
- Logic Elements
- DC**
- Directional Controls
- MV**
- Manual Valves
- SV**
- Solenoid Valves
- PV**
- Proportional Valves
- CE**
- Coils & Electronics
- BC**
- Bodies & Cavities
- TD**
- Technical Data

Technical Information

- CV** Check Valves
- SH** Shuttle Valves
- LM** Load/Motor Controls
- FC** Flow Controls
- PC** Pressure Controls
- LE** Logic Elements
- DC** Directional Controls
- MV** Manual Valves
- SV** Solenoid Valves
- PV** Proportional Valves
- CE** Coils & Electronics
- BC** Bodies & Cavities
- TD** Technical Data

General Description

3 Way, Normally Closed, Proportional Flow Regulator Valve. Pressure Compensated. For additional information see Technical Tips on pages PV1-PV6.

Features

- Analog proportional pressure compensated flow control valve regulates flow proportionally to the input solenoid current
- One piece cartridge housing ensures internal concentricity
- Coil: Waterproof, hermetically sealed, requires no O'Rings; Symmetrical coil can be reversed without affecting performance.

Specifications

Rated Inlet Flow	75 LPM (20 GPM)
Rated Regulated Flow	56.8 LPM (15 GPM) Requires ('SP' Coil)
Maximum Input Pressure At Port 3	210 Bar (3000 PSI)
Minimum Pressure Differential	13.8 Bar (200 PSI)
Maximum Internal Leakage	568 cc (35 cu. in.) @ 210 Bar (3000 PSI)
Hysteresis @ 100 Hz PWM	>15%
Cartridge Material	All parts steel. All operating parts hardened steel.
Operating Temp. Range/Seals	-40°C to +93.3°C (Nitrile) (-40°F to +200°F) -31.7°C to +121.1°C (Fluorocarbon) (-25°F to +250°F)
Fluid Compatibility/ Viscosity	Mineral-based or synthetic with lubricating properties at viscosities of 45 to 2000 SSU (6 to 420 cSt)
Filtration	ISO Code 16/13, SAE Class 4 or better
Approx. Weight	.45 kg (1.0 lbs.)
Cavity	C12-4L (See BC Section for more details)

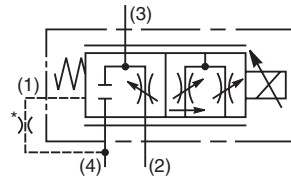

*Always connect Port (1) to Port (4) through .039" orifice.

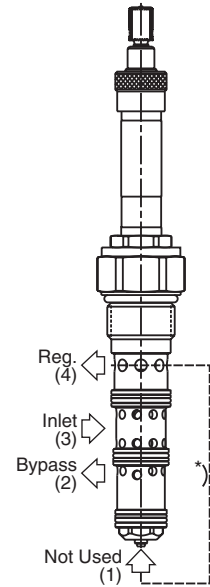

Performance Curves

▲ PWM Current Regulator Recommended

Pressure Compensation of Regulated Flow (Port 4)

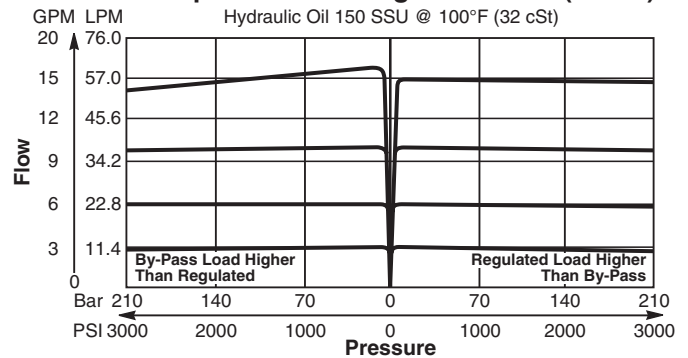

Regulated Flow vs. Input Current Stabilized

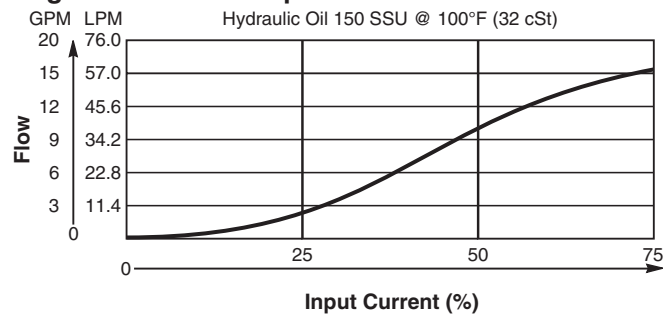

Pressure Drop vs. Flow (Through cartridge only)

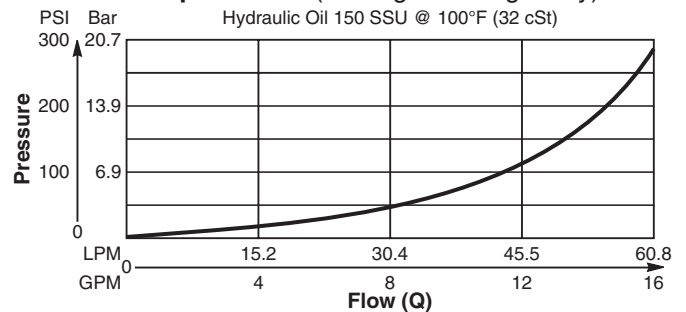

Dimensions Millimeters (Inches)

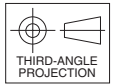
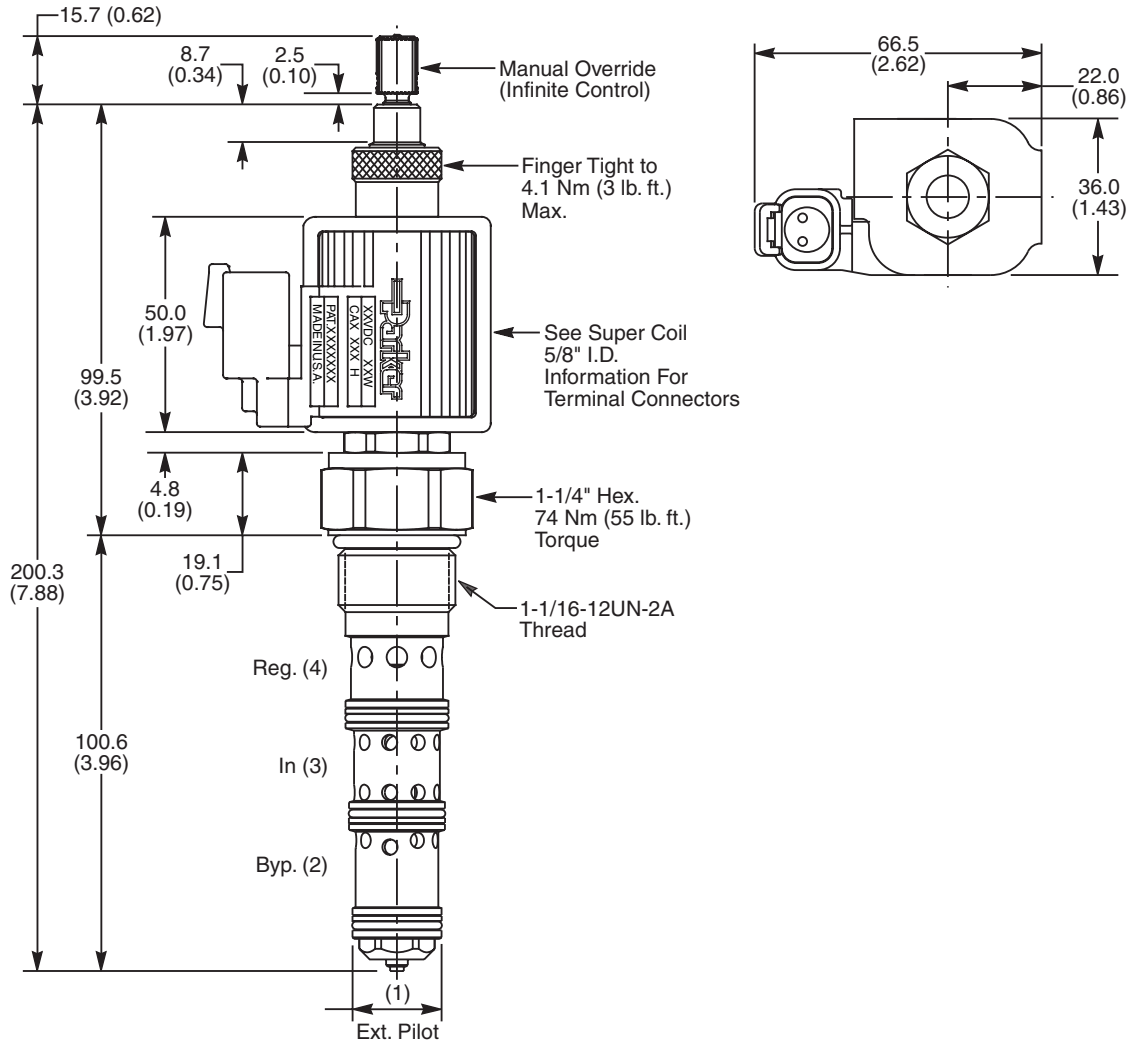

Ordering Information

DFA125C	31	S				
12 Size Proportional Valve	Style	Override Option	Seals	Coil Type	Coil Voltage	Coil Termination

Code	Style (Maximum Regulated Flow)
31	High Flow ("SP" Coil) 56.8 LPM (15 GPM)

Code	Coil Type
Omit	Without Coil
SP	Super Coil - 28 Watts

Code	Coil Termination
Omit	Without Coil
D	DIN Plug Face
A	Amp Jr. Timer*
S	Dual Spade*
L	Dual Lead Wire*
LS	Sealed Lead Wire*
H	Molded Deutsch*

See Super Coil 5/8" I.D.
*DC Only

Code	Override Option
Omit	Not Available
S	Standard M.O. (Infinite Control)

Code	Coil Voltage
Omit	Without Coil
D012	12 VDC
D024	24 VDC

Code	Seals / Kit No.
N	Nitrile / Buna-N (Std.) (SK12-4LN)
V	Fluorocarbon / (SK12-4LV)

Order Bodies Separately

B12	4L	A	12T
12 Size	4-Way Long Cavity	Body Material	Port Size

Code	Body Material
A	Aluminum

Code	Port Size
12T	SAE - 12



- CV** Check Valves
- SH** Shuttle Valves
- LM** Load/Motor Controls
- FC** Flow Controls
- PC** Pressure Controls
- LE** Logic Elements
- DC** Directional Controls
- MV** Manual Valves
- SV** Solenoid Valves
- PV** Proportional Valves
- CE** Coils & Electronics
- BC** Bodies & Cavities
- TD** Technical Data

Technical Information

- CV** Check Valves
- SH** Shuttle Valves
- LM** Load/Motor Controls
- FC** Flow Controls
- PC** Pressure Controls
- LE** Logic Elements
- DC** Directional Controls
- MV** Manual Valves
- SV** Solenoid Valves
- PV** Proportional Valves
- CE** Coils & Electronics
- BC** Bodies & Cavities
- TD** Technical Data

General Description

4 Way, 3 Position, Proportional Directional Control Valve. Closed Center Spool. For additional information see Technical Tips on pages PV1-PV6.

Features

- One piece cartridge housing ensures internal concentricity
- Coil: Waterproof, hermetically sealed, requires no O’Rings; Symmetrical coil can be reversed without affecting performance.

Specifications

Operating Pressure	Ports 2, 3 and 4 350 Bar (5000 PSI) Port 1 210 Bar (3000 PSI)
Hysteresis @ 100 Hz PWM	<6%
Cracking Flow	25% to 30% of Input Signal
Variation of Flow	±15% @ 75% of Nominal Current and Constant ΔP Maintained by Pressure Compensator
Port to Port Leakage	10 cu. in. @ 3000 PSI
Step Response Time at 75% of Amps	On 50 ms Off 40 ms
Cartridge Material	All parts steel. All operating parts hardened steel.
Operating Temp. Range/Seals	-40°C to +93.3°C (Nitrile) (-40°F to +200°F) -31.7°C to +121.1°C (Fluorocarbon) (-25°F to +250°F)
Fluid Compatibility/Viscosity	Mineral-based or synthetic with lubricating properties at viscosities of 45 to 2000 SSU (6 to 420 cSt)
Filtration	ISO Code 16/13, SAE Class 4 or better
Approx. Weight	.15 kg (.34 lbs.)
Cavity	C08-4

Typical Performance

SPOOL TYPE AND FLOW	RATED FLOW AT 75% OF NOMINAL CURRENT LPM - (GPM)		SUPER COIL TYPE		Compensator ΔP Bar (PSI)
	'a' SOLENOID PUSH P to A, B to T	'b' SOLENOID PULL P to B, A to T	PUSH	PULL	
51L Low Flow	5.3 - (1.4)	5.3 - (1.4)	SP	SP	10 (150)
	3.4 - (0.9)	3.4 - (0.9)	SS	SS	5 (75)
51 Standard	13.3 - (3.5)	17 - (4.5)	SP	SP	15 (220)
	11.4 - (3.0)	15.2 - (4.0)	SS	SS	15 (220)
52 High Flow	21 - (5.5)	17 - (4.5)	SP	SP	20 (290)
	17.4 - (4.5)	13 - (3.5)	SP	SP	15 (220)

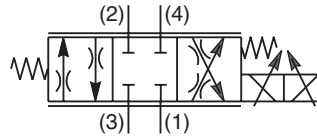
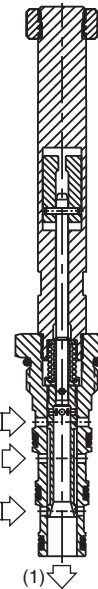

Performance Curves

▲ PWM Current Regulator Recommended

51L With 5 Bar, 75 PSI Compensator
51 With 15 Bar, 220 PSI Compensator and SS Coil

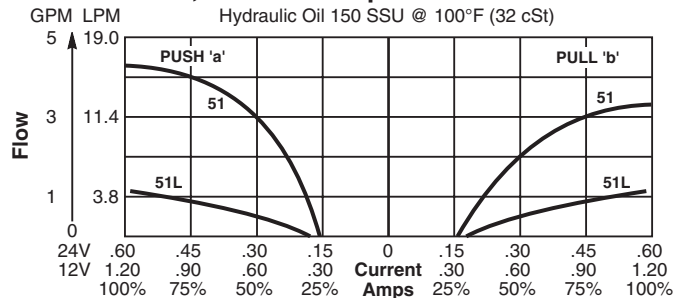

52 With 20 Bar, 290 PSI Compensator and SP Coil

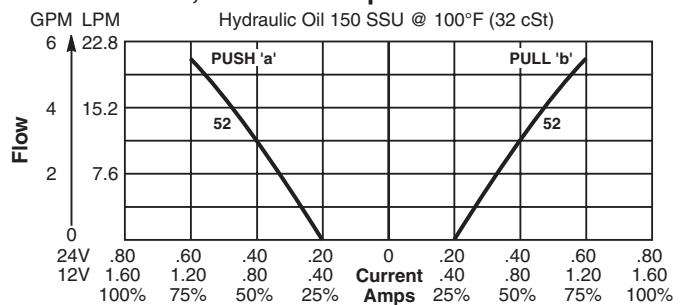

Flow vs. Load

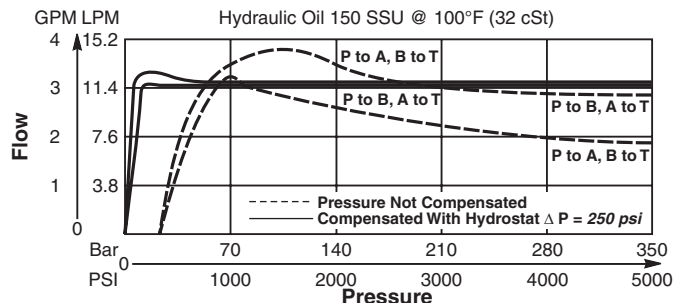

Technical Information

Dimensions Millimeters (Inches)

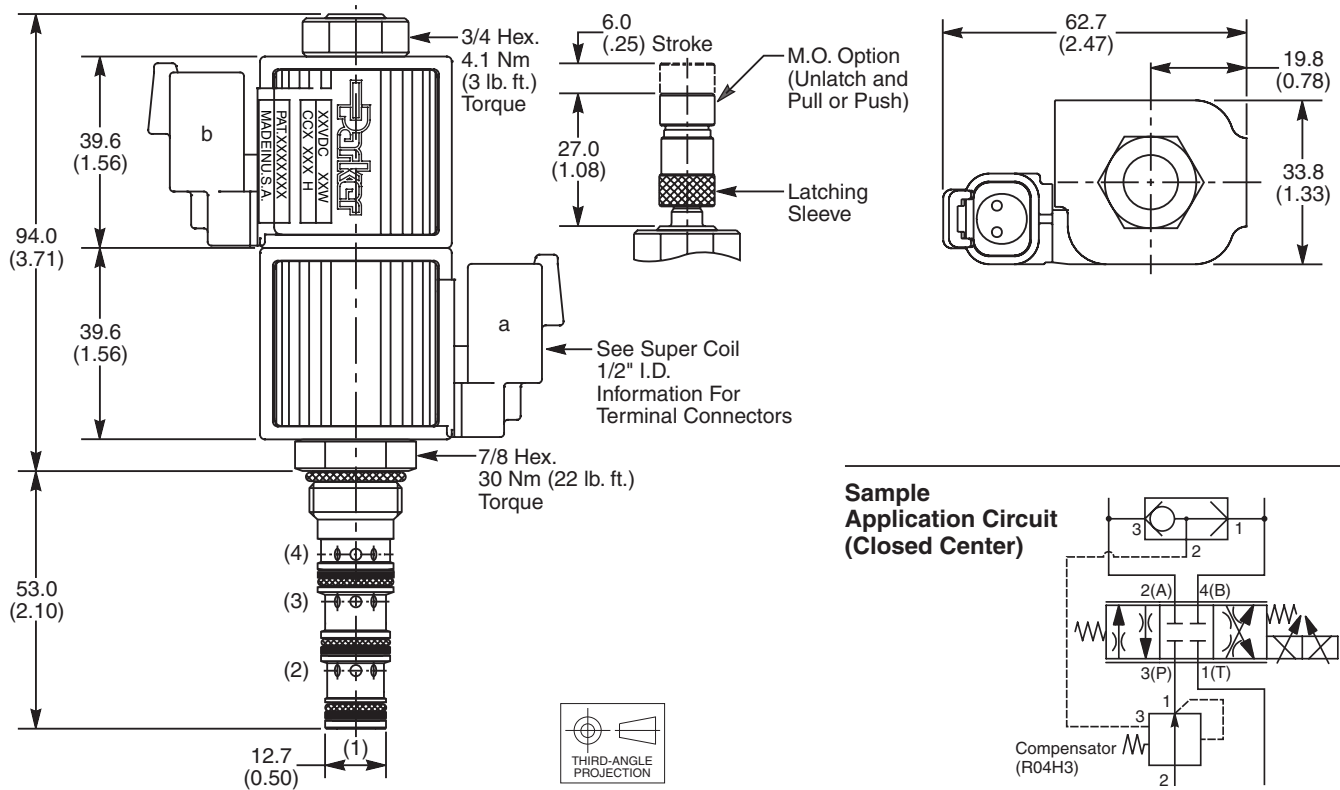

Sample Application Circuit (Closed Center)

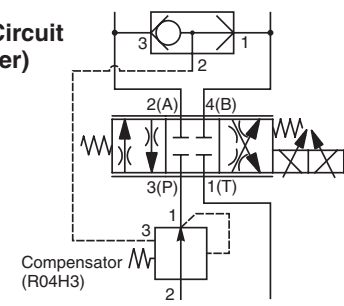

Ordering Information

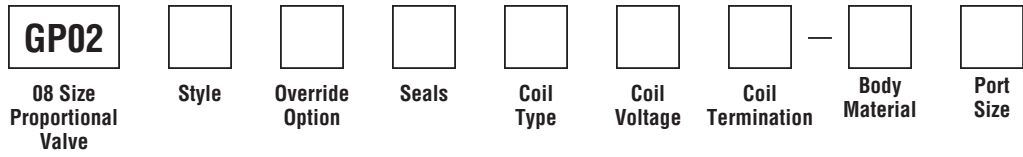

Code	Style - Closed Center (Flow Pressure and Performance)
51	Standard
51L	Low Flow
52	High Flow

Code	Seals / Kit No.
N	Nitrile / Buna-N (Std.) (SK30078N-1)
V	Fluorocarbon / (SK30078V-1)

Code	Coil Voltage
Omit	Without Coil
D012	12 VDC
D024	24 VDC

Code	Body Material
Omit	Steel
A	Aluminum

Code	Override Option
Omit	Not Required
1	Manual Override
2	Detented M.O.

Code	Coil Type
Omit	Without Coil
SS	Super Coil - 14 Watts
SP	Super Coil - 19 Watts

Code	Coil Termination
Omit	Without Coil
D	DIN Plug Face
A	Amp Jr. Timer*
L	Dual Lead Wire*
LS	Sealed Lead Wire*
H	Molded Deutsch*

Code	Port Size	Body Part No.
Omit	Cartridge Only	
4T	SAE-4	(B08-4-*4T)
6T	SAE-6	(B08-4-*6T)
6B	3/8" BSPG	(B08-4-*6B)

* Add "A" for aluminum, omit for steel.

See Super Coil 1/2" I.D.
*DC Only

- CV Check Valves
- SH Shuttle Valves
- LM Load/Motor Controls
- FC Flow Controls
- PC Pressure Controls
- LE Logic Elements
- DC Directional Controls
- MV Manual Valves
- SV Solenoid Valves
- PV Proportional Valves
- CE Coils & Electronics
- BC Bodies & Cavities
- TD Technical Data



Technical Information

- CV** Check Valves
- SH** Shuttle Valves
- LM** Load/Motor Controls
- FC** Flow Controls
- PC** Pressure Controls
- LE** Logic Elements
- DC** Directional Controls
- MV** Manual Valves
- SV** Solenoid Valves
- PV** Proportional Valves
- CE** Coils & Electronics
- BC** Bodies & Cavities
- TD** Technical Data

General Description

4 Way, 3 Position, Proportional Directional Control Valve. Floating Center Spool. For additional information see Technical Tips on pages PV1-PV6.

Features

- One piece cartridge housing ensures internal concentricity
- Coil: Waterproof, hermetically sealed, requires no O'Rings; Symmetrical coil can be reversed without affecting performance.

Specifications

Operating Pressure	Ports 2, 3 and 4 350 Bar (5000 PSI) Port 1 210 Bar (3000 PSI)
Hysteresis @ 100 Hz PWM	<6%
Cracking Flow	25% to 30% of Input Signal
Variation of Flow	±15% @ 75% of Nominal Current and Constant ΔP Maintained by Pressure Compensator
Port to Port Leakage	10 cu. in. @ 3000 PSI
Step Response Time at 75% of Amps	On 50 ms Off 40 ms
Cartridge Material	All parts steel. All operating parts hardened steel.
Operating Temp. Range/Seals	-40°C to +93.3°C (Nitrile) (-40°F to +200°F) -31.7°C to +121.1°C (Fluorocarbon) (-25°F to +250°F)
Fluid Compatibility/Viscosity	Mineral-based or synthetic with lubricating properties at viscosities of 45 to 2000 SSU (6 to 420 cSt)
Filtration	ISO Code 16/13, SAE Class 4 or better
Approx. Weight	.15 kg (.34 lbs.)
Cavity	C08-4

Typical Performance

SPOOL TYPE AND FLOW	RATED FLOW AT 75% OF NOMINAL CURRENT LPM - (GPM)		SUPER COIL TYPE		Compensator ΔP Bar (PSI)
	'a' SOLENOID PUSH P to A, B to T	'b' SOLENOID PULL P to B, A to T	PUSH	PULL	
53L Low Flow	5.3 - (1.4)	5 - (1.4)	SP	SP	10 (150)
	4 - (1.0)	4 - (1.0)	SS	SS	5 (75)
53 Standard	14 - (3.8)	15 - (4.0)	SP	SP	10 (150)
	9 - (2.5)	10 - (2.7)	SS	SS	5 (75)
54 High Flow	17 - (4.5)	19 - (5.0)	SP	SP	20 (290)
	15 - (4.0)	15 - (4.0)	SS	SS	15 (220)

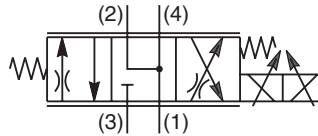
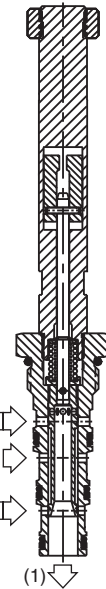

Performance Curves

▲ PWM Current Regulator Recommended
53 and 53L With 5 Bar, 75 PSI Compensator and SS Coil

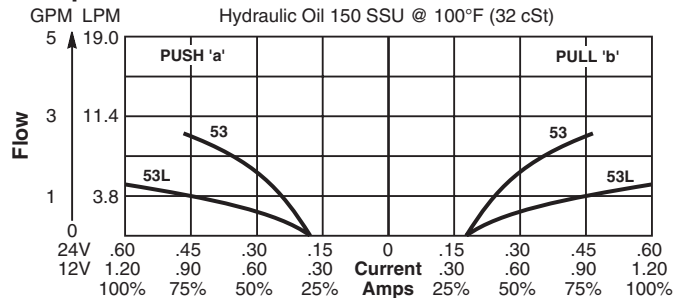

54 With 20 Bar, 290 PSI Compensator and SP Coil

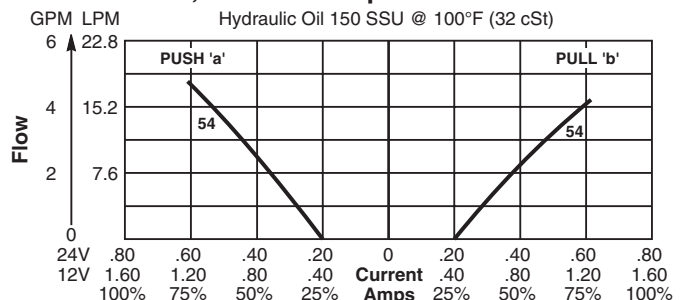

Flow vs. Load

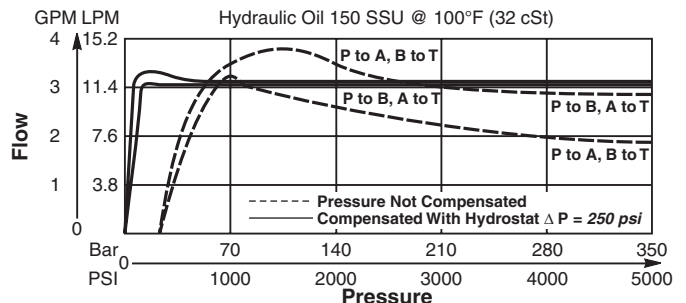

Technical Information

Dimensions Millimeters (Inches)

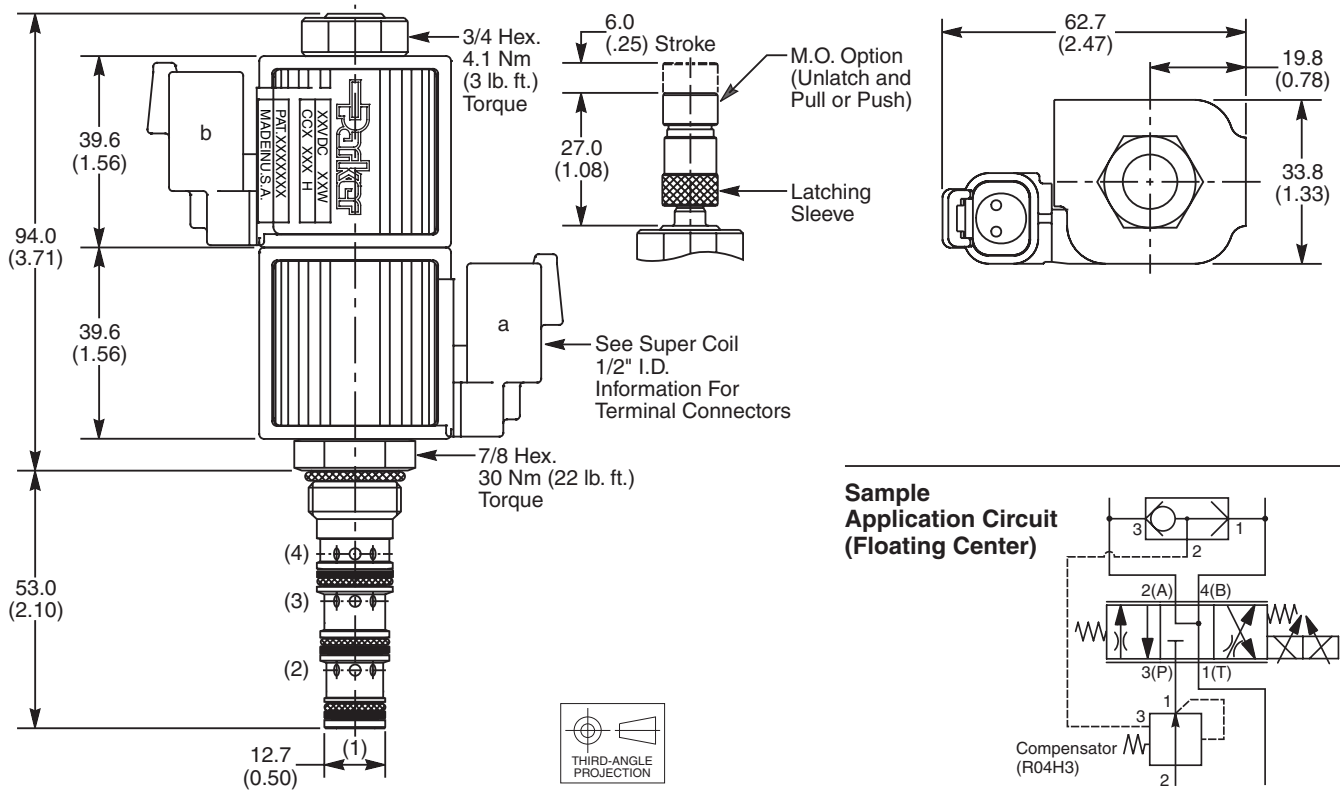

Ordering Information

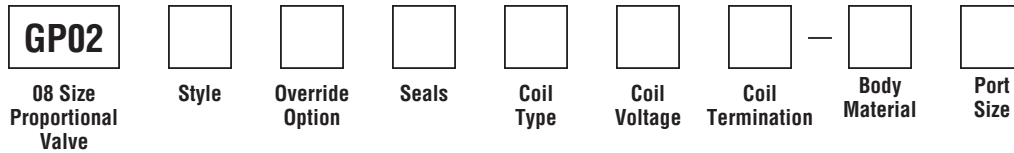

Code	Style - Floating Center (Flow Pressure and Performance)
53	Standard
53L	Low Flow
54	High Flow

Code	Seals / Kit No.
N	Nitrile / Buna-N (Std.) (SK30078N-1)
V	Fluorocarbon / (SK30078V-1)

Code	Coil Voltage
Omit	Without Coil
D012	12 VDC
D024	24 VDC

Code	Body Material
Omit	Steel
A	Aluminum

Code	Override Option
Omit	Not Required
1	Manual Override
2	Detented M.O.

Code	Coil Type
Omit	Without Coil
SS	Super Coil - 14 Watts
SP	Super Coil - 19 Watts

Code	Coil Termination
Omit	Without Coil
D	DIN Plug Face
A	Amp Jr. Timer*
L	Dual Lead Wire*
LS	Sealed Lead Wire*
H	Molded Deutsch*

Code	Port Size	Body Part No.
Omit	Cartridge Only	
4T	SAE-4	(B08-4-*4T)
6T	SAE-6	(B08-4-*6T)
6B	3/8" BSPG	(B08-4-*6B)

* Add "A" for aluminum, omit for steel.

See Super Coil 1/2" I.D.
*DC Only

- CV Check Valves
- SH Shuttle Valves
- LM Load/Motor Controls
- FC Flow Controls
- PC Pressure Controls
- LE Logic Elements
- DC Directional Controls
- MV Manual Valves
- SV Solenoid Valves
- PV Proportional Valves
- CE Coils & Electronics
- BC Bodies & Cavities
- TD Technical Data

Technical Information

- CV** Check Valves
- SH** Shuttle Valves
- LM** Load/Motor Controls
- FC** Flow Controls
- PC** Pressure Controls
- LE** Logic Elements
- DC** Directional Controls
- MV** Manual Valves
- SV** Solenoid Valves
- PV** Proportional Valves
- CE** Coils & Electronics
- BC** Bodies & Cavities
- TD** Technical Data

General Description

4 Way, 3 Position, Proportional Directional Control Valve. Closed Center or Floating Center Spool. For additional information see Technical Tips on pages PV1-PV6.

Features

- One piece cartridge housing ensures internal concentricity
- Coil: Waterproof, hermetically sealed, requires no O'Rings; Symmetrical coil can be reversed without affecting performance.
- All external parts zinc plated

Specifications

Operating Pressure	210 Bar (3000 PSI)
Hysteresis @ 100 Hz PWM	<6%
Cracking Flow	25% to 30% of Input Signal
Variation of Flow	±15% @ 75% of Nominal Current and Constant ΔP Maintained by Pressure Compensator
Port to Port Leakage	10 cu. in. @ 3000 PSI
Step Response Time at 75% of Amps	On 50 ms Off 40 ms
Cartridge Material	All parts steel. All operating parts hardened steel.
Operating Temp. Range/Seals	-45°C to +93.3°C ("D"-Ring) (-50°F to +200°F) -31.7°C to +121.1°C (Fluorocarbon) (-25°F to +250°F)
Fluid Compatibility/ Viscosity	Mineral-based or synthetic with lubricating properties at viscosities of 45 to 2000 SSU (6 to 420 cSt)
Filtration	ISO Code 16/13, SAE Class 4 or better
Approx. Weight	.28 kg (.57 lbs.)
Cavity	C10-4

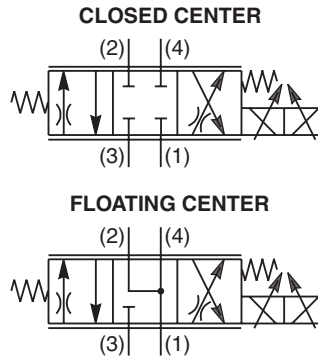
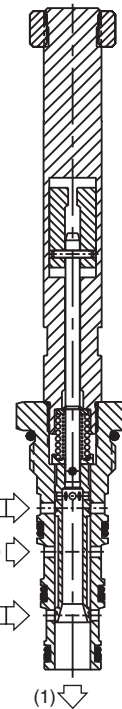

Sample Application Circuit

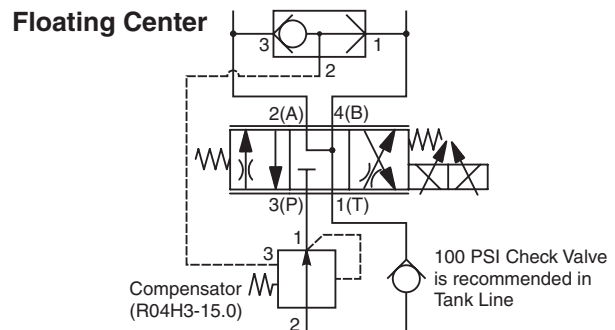
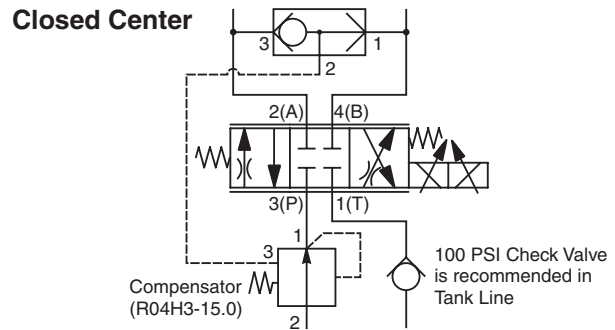

Dimensions Millimeters (Inches)

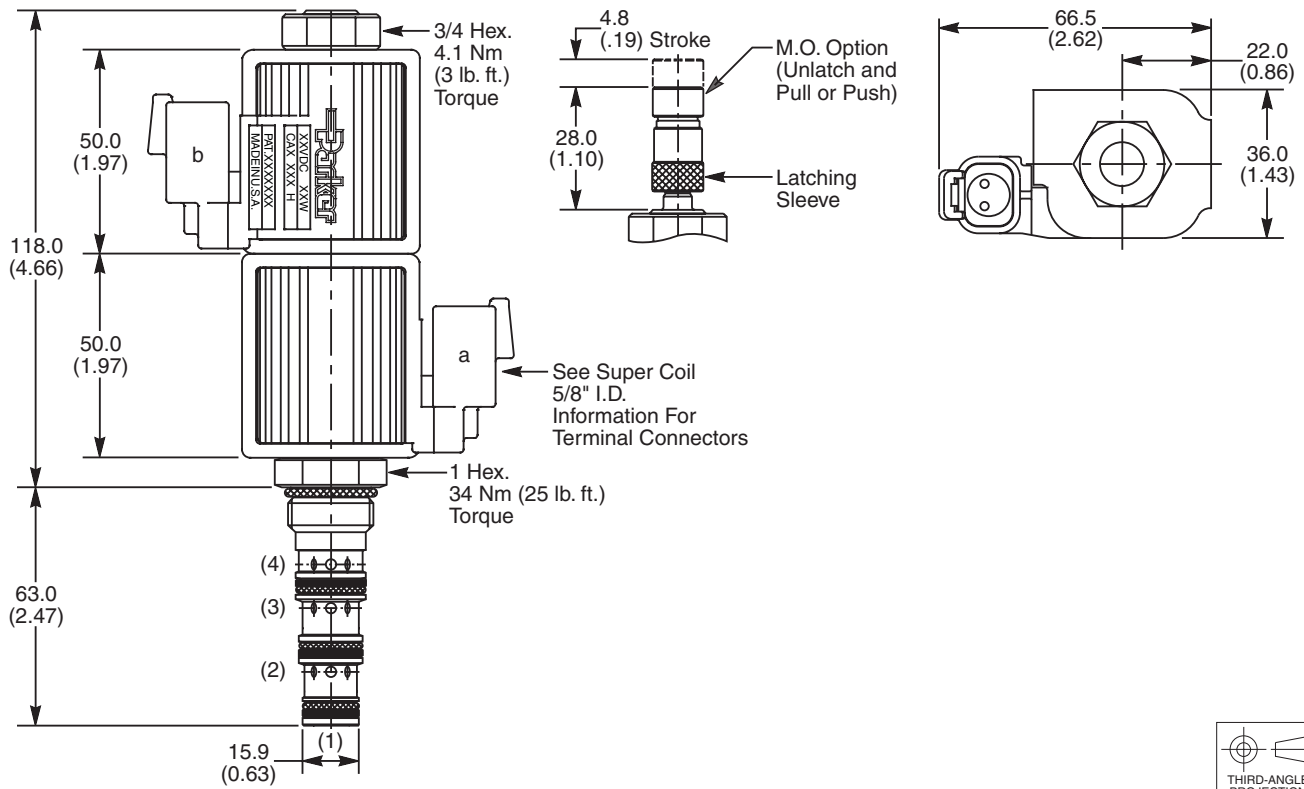

Ordering Information

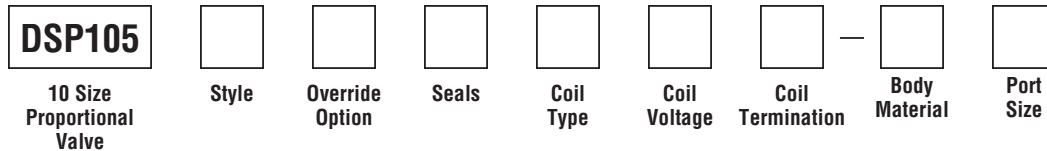

Code	Style
C1	
C4	

Code	Seals / Kit No.
Omit	"D"-Ring / (SK10-4)
N	Nitrile / (SK10-4N)
V	Fluorocarbon / (SK10-4V)

Code	Coil Type
Omit	Without Coil
SP	Super Coil - 28 Watts

Code	Coil Voltage
Omit	Without Coil
D012	12 VDC
D024	24 VDC

Code	Coil Termination
Omit	Without Coil
D	DIN Plug Face
A	Amp Jr. Timer*
L	Dual Lead Wire*
H	Molded Deutsch*

Code	Body Material
Omit	Steel
A	Aluminum

Code	Port Size	Body Part No.
Omit	Cartridge Only	
6P	3/8" NPTF	(B10-4-*6P)
6T	SAE-6	(B10-4-*6T)
8T	SAE-8	(B10-4-*8T)
6B	3/8" BSPG	(B10-4-6B)†

* Add "A" for aluminum, omit for steel.
 † Steel body only.

Code	Override Option
Omit	None
M	Push/Pull

See Super Coil 5/8" I.D.
 *DC Only

- CV Check Valves
- SH Shuttle Valves
- LM Load/Motor Controls
- FC Flow Controls
- PC Pressure Controls
- LE Logic Elements
- DC Directional Controls
- MV Manual Valves
- SV Solenoid Valves
- PV Proportional Valves
- CE Coils & Electronics
- BC Bodies & Cavities
- TD Technical Data

- CV** Check Valves
- SH** Shuttle Valves
- LM** Load/Motor Controls
- FC** Flow Controls
- PC** Pressure Controls
- LE** Logic Elements
- DC** Directional Controls
- MV** Manual Valves
- SV** Solenoid Valves
- PV** Proportional Valves
- CE** Coils & Electronics
- BC** Bodies & Cavities
- TD** Technical Data

▲ PWM Current Regulator Recommended

51 With 15 Bar, 220 PSI Compensator and SP Coil

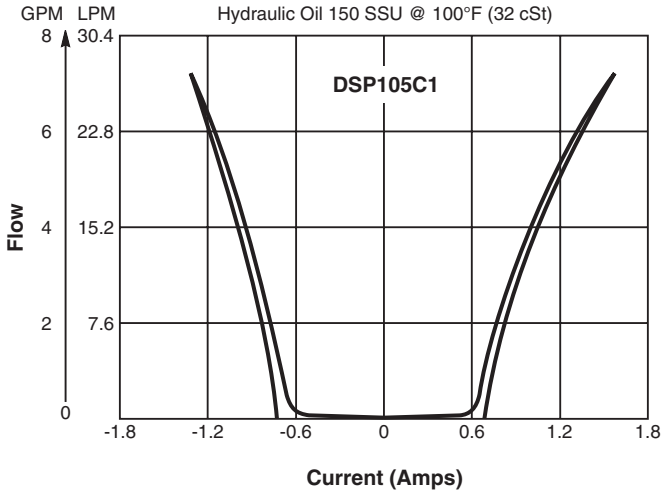

53 With 15 Bar, 220 PSI Compensator and SP Coil

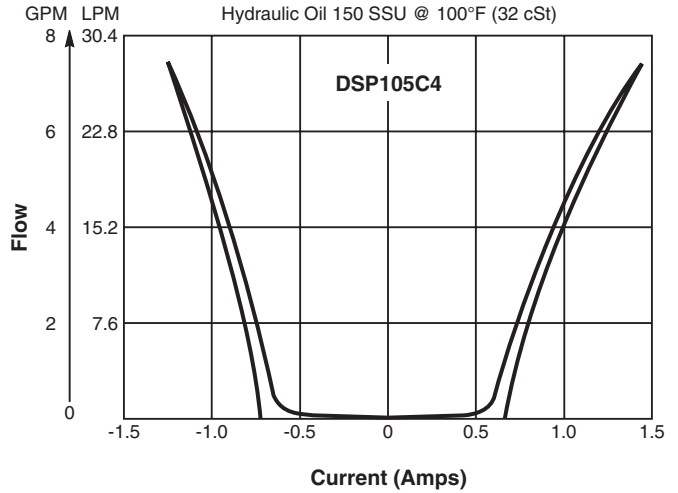

**Pressure Compensation Pull Coil
 Inlet to Work Port**

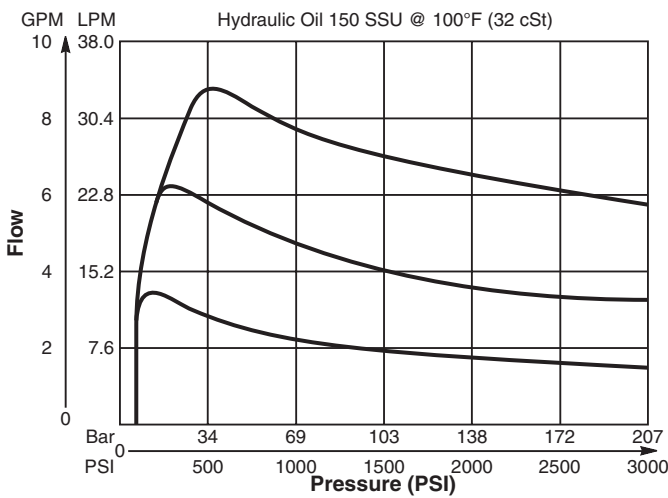

**Pressure Compensation Push Coil
 Inlet to Work Port**

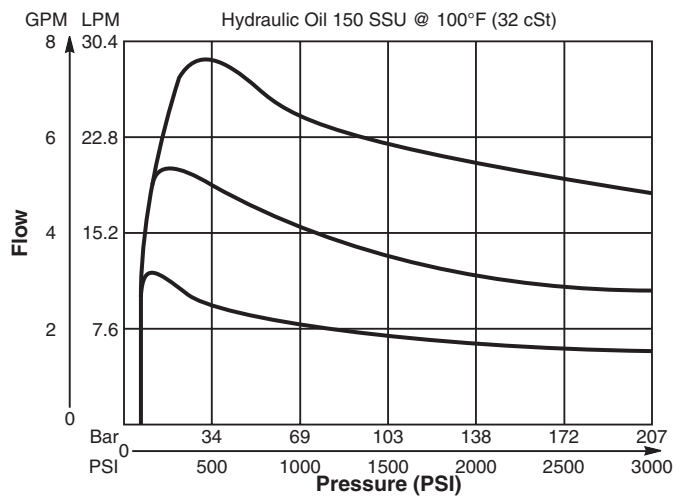

51 Spool Port 3 to 4

