

Features

Directair 2, 1/8" valves
Poppet style – .17 Cv

- Economical
- 3-way normally closed function

Directair 2, 1/8" valves
Packed bore style – .20 Cv

- Stainless steel spool
- Fluorocarbon o-rings
- 3-way & 4-way

Directair 4, 1/4" valves
Packed bore style – .83 Cv

- Stainless steel spool
- Fluorocarbon o-rings
- 3-way & 4-way

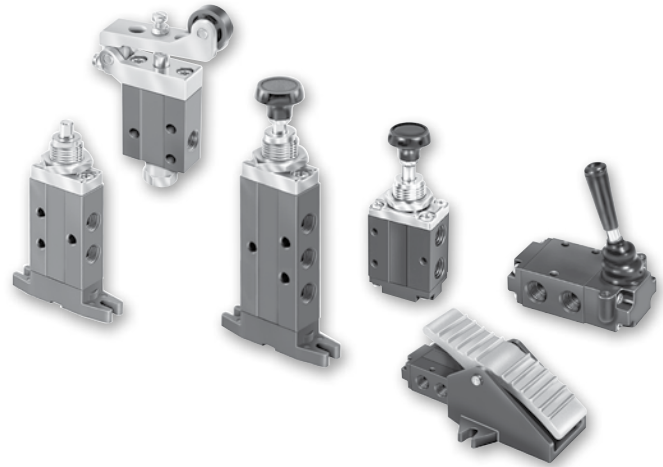

Brass Poppet /
Sliding Seal

LV-EZ Series
Lockout Valves

M0
Series

Viking Xtreme
Lever Series

42 Lever /
Pedal Series

Directair 2,
Directair 4

D

Manual / Mechanical
Valve Products

Material specifications

Body and operator housings	Aluminum extrusion
Bushings and pilot piston	Brass
Dynamic seals	Fluorocarbon
O-rings	Buna (nitrile)
Poppet ball	Nylon
Spacers - Directair 2	Aluminum
Spacers - Directair 4	Zinc die cast
Spool	Stainless steel

Lubrication

For maximum service life use clean, lubricated air. Valves are shipped pre-lubricated and can be operated without additional lubrication with reduced service life.

Suggested Lubricant

F442 Oil

Operating information

Operating pressure	Vacuum to 150 PSI (28 inHg to 1035 kPa)*
Temperature range	32°F to 175°F (0°C to 80°C)
* Poppet valves cannot be used for vacuum. Minimum operating pressure = 0 PSIG.	

CAUTION:
 If it is possible that the ambient temperature may fall below freezing, the medium must be moisture free to prevent internal damage or unpredictable behavior.

Mechanically operated actuating forces in lbs.
1/4" Directair 4 valves

	2-Position Spring Return	2-Position Manual Return	3-Position Spring Return	3-Position Manual Return
Button Actuator	13.0	2.0	13.0	N/A
Roller Actuator	13.0	N/A	N/A	N/A
Lever Actuator	4.0	2.0	4.0	2.5

Notes: N/A = Not Applicable
 All valves are at 100 PSIG inlet pressure to the valve.

☐ Most popular. For technical information see CD



3-way & 4-way Valves

	Symbol	Port size	Cv	Description	Valve type	Part number	
Button operated, 3-way		1/8"	.17	3-way, spring return	Poppet	404411000	
		1/8"	.20	3-way, spring return	Spool	414411000	
		1/8"	.20	3-way, spring return, foot mounted	Spool	414421000	
		1/8"	.20	3-way, pilot return	Spool	414451000	
		1/8"	.20	3-way, manual return	Spool	414931000	
		1/8"	.20	3-way, manual return, foot mounted	Spool	414941000	
		1/8"	.20	3-way, manual or pilot return	Spool	414951000	
		1/4"	.83	3-way, spring return	Spool	524411000	
		1/4"	.83	3-way, pilot return	Spool	524451000	
		1/4"	.83	3-way, manual return	Spool	524431000	
	Button operated, 4-way		1/8"	.20	4-way, spring return	Spool	410411000
			1/8"	.20	4-way, spring return, foot mounted	Spool	410421000
		1/8"	.20	4-way, pilot return	Spool	410451000	
		1/8"	.20	4-way, manual return	Spool	410931000	
		1/8"	.20	4-way, manual return, foot mounted	Spool	410941000	
		1/8"	.20	4-way, manual or pilot return	Spool	410951000	
		1/4"	.83	4-way, spring return	Spool	520411000	
		1/4"	.83	4-way, pilot return	Spool	520451000	
		1/4"	.83	4-way, manual return	Spool	520431000	
Toggle operated, detented			1/8"	.17	3-way, spring return	Poppet	404811000
			1/8"	.20	3-way, spring return	Spool	414811000
			1/8"	.20	3-way, spring return, foot mounted	Spool	414821000
		1/8"	.20	4-way, spring return	Spool	410811000	
		1/8"	.20	4-way, spring return, foot mounted	Spool	410821000	

Brass Poppet /
Sliding Seal

LV-EZ Series
Lockout Valves

M0
Series

Viking Xtreme
Lever Series





42 Lever /
Pedal Series

Directair 2,
Directair 4

D
Manual / Mechanical
Valve Products

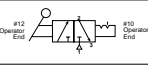
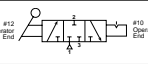
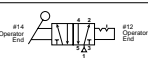
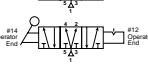
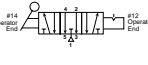

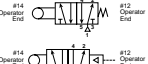









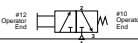
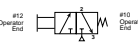
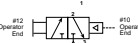
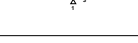

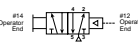
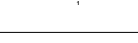

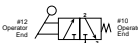
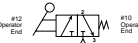
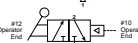
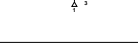

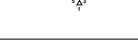

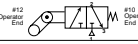
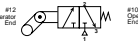
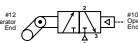
3-way & 4-way Valves

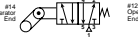
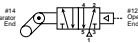
	Symbol	Port size	Cv	Description	Valve type	Part number	
Lever operated 		1/4"	.83	3-way, spring return	Spool	524811000	
		1/4"	.83	3-way, manual return	Spool	524831000	
		1/4"	.83	3-way, 3-Position detented, all ports blocked	Spool	523831000	
		1/4"	.83	4-way, spring return	Spool	520811000	
		1/4"	.83	4-way, manual return	Spool	520831000	
		1/4"	.83	4-way, spring centered, closed center	Spool	521811000	
		1/4"	.83	4-way, spring centered, pressure center	Spool	522811000	
		1/4"	.83	4-way, spring centered, exhaust center	Spool	529811000	
		1/4"	.83	4-way, detented, closed center	Spool	521831000	
		1/4"	.83	4-way, detented, pressure center	Spool	522831000	
		1/4"	.83	4-way, detented, exhaust center	Spool	529831000	
	Roller operated 		1/8"	.20	3-way, spring return	Poppet	404211000
		1/8"	.20	3-way, spring return	Spool	414211000	
		1/8"	.20	3-way, spring return, foot mounted	Spool	414221000	
		1/8"	.20	3-way, pilot return	Spool	414251000	
		1/8"	.20	4-way, spring return	Spool	410211000	
		1/8"	.20	4-way, spring return, foot mounted	Spool	410221000	
		1/8"	.20	4-way, pilot return	Spool	410251000	
Roller operated 			1/4"	.83	3-way, spring return, delrin roller	Spool	524211000
			1/4"	.83	3-way, pilot return, delrin roller	Spool	524251000
			1/4"	.83	3-way, spring return, steel roller	Spool	524A11000
			1/4"	.83	3-way, pilot return, steel roller	Spool	524A51000
			1/4"	.83	4-way, spring return, delrin roller	Spool	520211000
		1/4"	.83	4-way pilot return, delrin roller	Spool	520251000	
		1/4"	.83	4-way, spring return, steel roller	Spool	520A11000	
		1/4"	.83	4-way, pilot return, steel roller	Spool	520A51000	

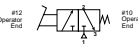

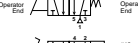
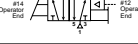
3-way & 4-way Valves

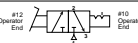
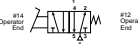
	Symbol	Port size	Cv	Description	Valve type	Part number	
Plunger operated  		1/8"	.17	3-way, spring return	Poppet	404111000	
		1/8"	.20	3-way, spring return	Spool	414111000	
		1/8"	.20	3-way, spring return, foot mounted	Spool	414121000	
		1/8"	.20	3-way, pilot return	Spool	414151000	
		1/8"	.17	4-way, spring return	Spool	410111000	
		1/8"	.20	4-way, spring return, foot mounted	Spool	410121000	
		1/8"	.20	4-way, pilot return	Spool	410151000	
	Hand lever operated  		1/8"	.17	3-way, spring return	Poppet	404711000
			1/8"	.20	3-way, spring return	Spool	414711000
			1/8"	.20	3-way, spring return, foot mounted	Spool	414721000
		1/8"	.20	3-way, pilot return	Spool	414751000	
		1/8"	.20	4-way, spring return	Spool	410711000	
		1/8"	.20	4-way, spring return, foot mounted	Spool	410721000	
		1/8"	.20	4-way, pilot return	Spool	410751000	
One way tripper operated  			1/8"	.17	3-way, spring return	Poppet	404311000
			1/8"	.20	3-way, spring return	Spool	414311000
			1/8"	.20	3-way, spring return, foot mounted	Spool	414321000
		1/8"	.20	3-way, pilot return	Spool	414351000	
		1/8"	.20	4-way, spring return	Spool	414311000	
		1/8"	.20	4-way, spring return, foot mounted	Spool	414321000	
		1/8"	.20	4-way, pilot return	Spool	414351000	
	Pedal operated 		1/4"	.83	3-way, spring return	Spool	524711000
			1/4"	.83	3-way, pilot return	Spool	524751000
			1/4"	.83	4-way, spring return	Spool	520711000
		1/4"	.83	4-way, pilot return	Spool	520751000	
Treadle operated 			1/4"	.83	3-way, treadle operated, detented	Spool	524931000
		1/4"	.83	4-way, treadle operated, detented	Spool	520931000	

CAUTION:
 This valve shall not be used to actuate a punch press. Do not use this valve on punch presses or press brakes. See OSHA 1910.217.

CAUTION:
 This valve shall not be used to actuate a punch press. Do not use this valve on punch presses or press brakes. See OSHA 1910.217.

Brass Poppet /
 Sliding Seal

LV-EZ Series
 Lockout Valves

M0
 Series

Viking Xtreme
 Lever Series

42 Lever /
 Pedal Series

Directair 2,
 Directair 4

D
 Manual / Mechanical
 Valve Products



Service kits – 1/8 port size valves (DA2)

①	Spool valve seal kit (3 & 4-way, direct pipe ported)	410008000
②	Poppet valve seal kit	404118000
③	Body service kit	410008005

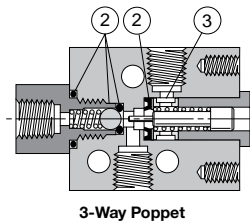
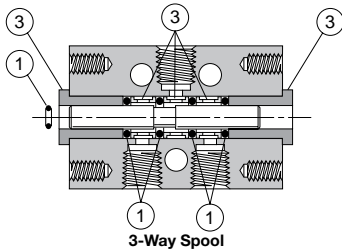
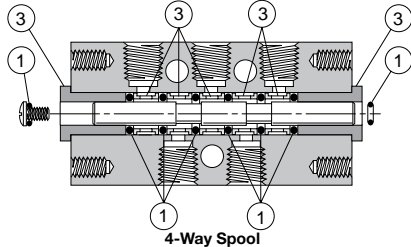

Panel Mounting Kit – No. 520838004

Available for panel mounting direct pipe ported, lever operated 1/4" Directair 4 Series valves only. Kit includes a flange and two screws.

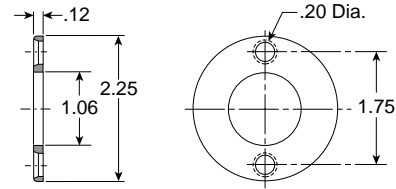

Pedal Guard Kit – No. 520718001

Pedal guard meets safety requirements for foot operated valves by protecting pedal from accidental tripping from all angles. Guard is constructed of lightweight aluminum casting for strength and durability. Bolts quickly into place with only three screws without special valve mounting. One model fits any pedal (not treadle) operated 1/4" Directair 4 Series valve.

⚠ CAUTION:

*This valve shall not be used to actuate a punch press.
 Do not use this valve on punch presses or press brakes.
 See OSHA 1910.217.*

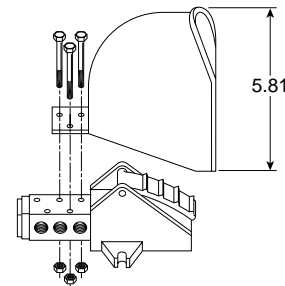

Service kits – 1/4 port size valves (DA4)

●	Valve seal kit (Contains all soft seals found in 3 & 4-way bodies and all actuator styles.) All fluorocarbon	520008050
■	Body service kit (Contains bushing, springs, retainers and shell from 2 & 3-position, 3 & 4-way bodies.)	520018005

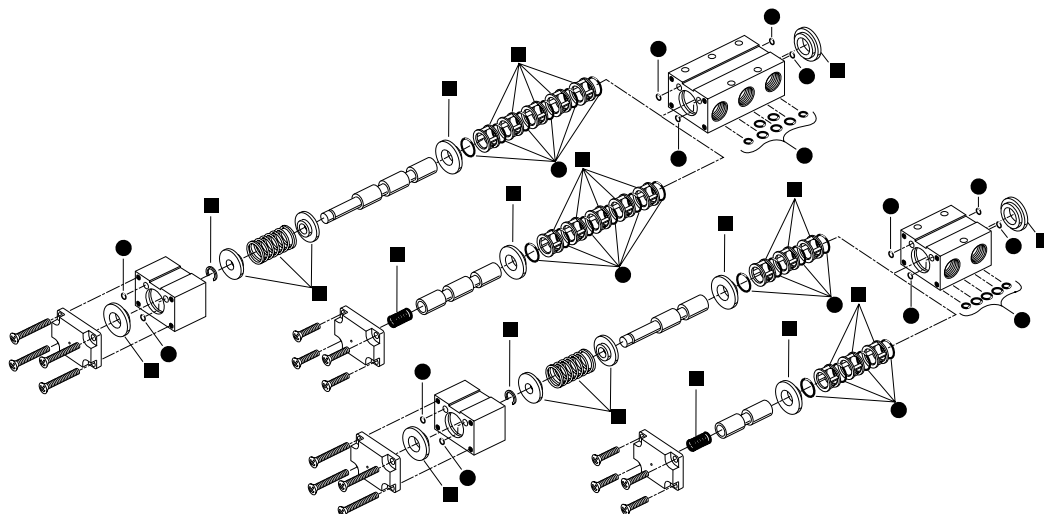

Brass Poppet / Sliding Seal
 LV-EZ Series Lockout Valves
 M0 Series
 Viking Xtreme Lever Series
 42 Lever / Pedal Series
 Directair 2, Directair 4
D
 Manual / Mechanical Valve Products

Plunger, Roller, One-way Tripper & Toggle Operated — 3-Way, 3-Port, 2-Position – 1/8" Ports

Plunger Operated

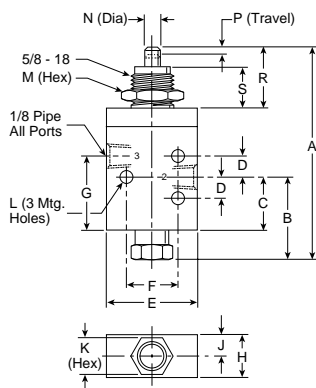

Roller Operated

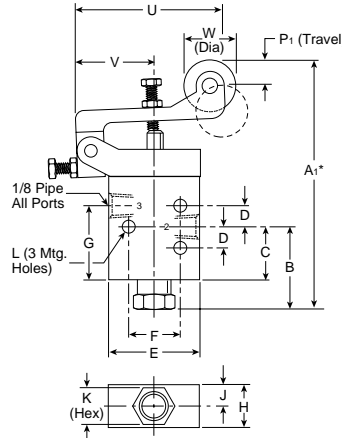

One-Way Tripper Operated

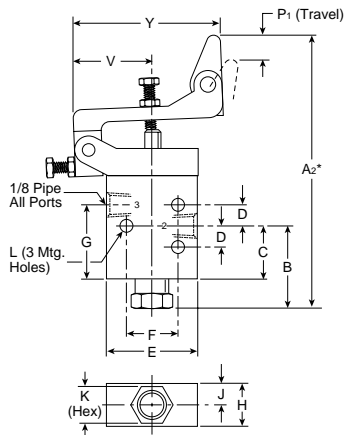

Toggle Operated

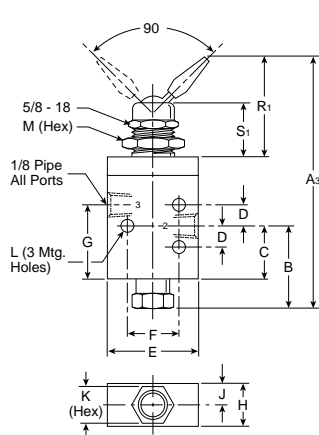

3-Way, 3-Port, 2-Position

A	A₁[*]	A₂[*]	A₃	B
3.37 (86)	4.21 (107)	4.46 (113)	3.99 (101)	1.03 (26)
C	D	E	F	G
.55 (14)	.31 (8)	1.31 (33)	.75 (19)	.90 (23)
H	J	K	L	M
.62 (16)	.31 (8)	.56 (14)	.19 (5)	.88 (22)
N	P	P₁	R	R₁
.25 (6)	.17 (4)	.38 (10)	.91 (23)	1.53 (39)
S	S₁	U	V	W
.62 (16)	.78 (20)	2.28 (58)	1.19 (30)	.75 (19)
X	Y			
.19 (5)	2.19 (56)			

* Dimensions may be reduced .44" using adjusting screw.
 Inches (mm)

Button & Hand Lever Operated — 3-Way, 3-Port, 2-Position – 1/8" Ports

Button Operated

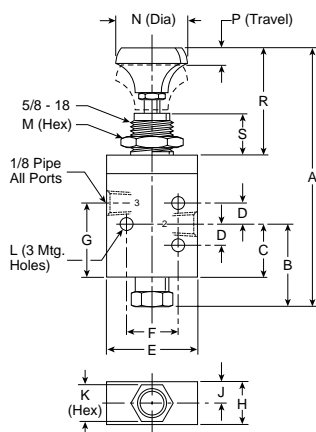

Hand Lever Operated

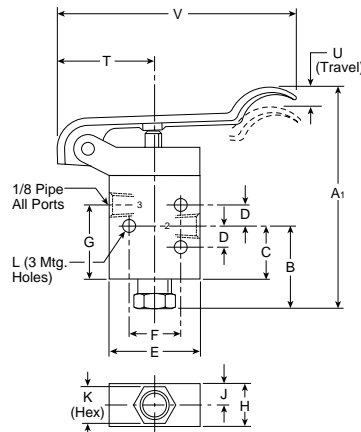

3-Way, 3-Port, 2-Position

A	A₁	B	C	D
4.13 (105)	3.34 (85)	1.03 (26)	.55 (14)	.31 (8)
E	F	G	H	J
1.31 (33)	.75 (19)	.90 (23)	.62 (16)	.31 (8)
K	L	M	N	P
.56 (14)	.19 (5)	.88 (22)	1.06 (27)	.17 (4)
R	S	T	U	V
1.67 (42)	.63 (16)	1.19 (30)	.53 (13)	3.38 (86)

Inches (mm)



Brass Poppet/
Sliding Seal

LV-EZ Series
Lockout Valves

M0
Series

Viking Xtreme
Lever Series

42 Lever/
Pedal Series

Directair 2,
Directair 4

D

Manual / Mechanical
Valve Products

Plunger, Roller, One-way Tripper & Toggle Operated — 3-Way, 3-Port, 2-Position – 1/8" Ports

Plunger Operated

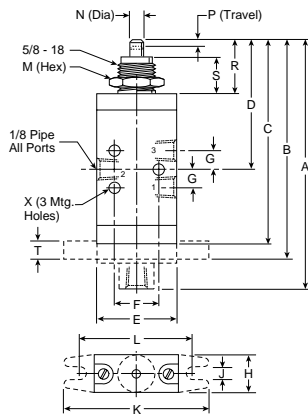

Roller Operated

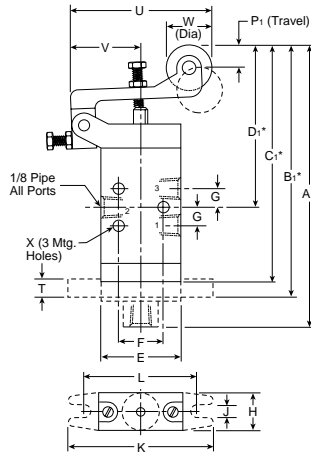

One-Way Tripper Operated

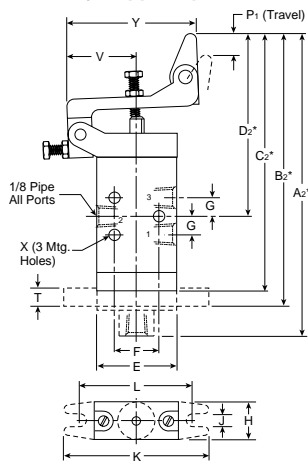

Toggle Operated

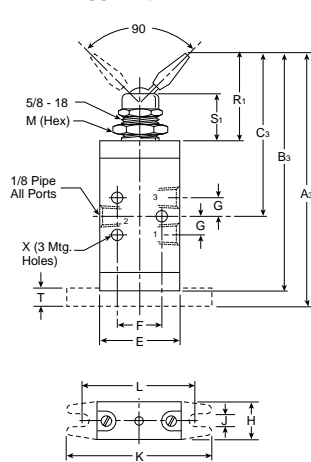

3-Way, 3-Port, 2-Position

A	A1*	A2*	A3	B
4.14 (105)	4.98 (126)	5.23 (133)	4.23 (107)	3.61 (92)
B1	B2	B3	C	C1
4.45 (113)	4.70 (119)	4.00 (102)	3.38 (86)	4.22 (107)
C2	C3	D	D1	D2
4.47 (113)	2.75 (70)	2.05 (52)	2.98 (76)	3.22 (82)
E	F	G	H	J
1.31 (33)	.75 (19)	.31 (8)	.62 (16)	.20 (5)
K	L	M	N	P
2.38 (60)	1.88 (48)	.88 (22)	.25 (6)	.17 (4)
P1	R	R1	S	S1
.38 (10)	.91 (23)	1.53 (39)	.62 (16)	.78 (20)
T	U	V	W	X
.25 (6)	2.28 (58)	1.19 (30)	.75 (19)	.19 (5)
Y				
2.19 (56)				

* Dimensions may be reduced .44" using adjusting screw.
 Inches (mm)

Button, Hand Lever Operated — 3-Way, 3-Port, 2-Position – 1/8" Ports

Button Operated

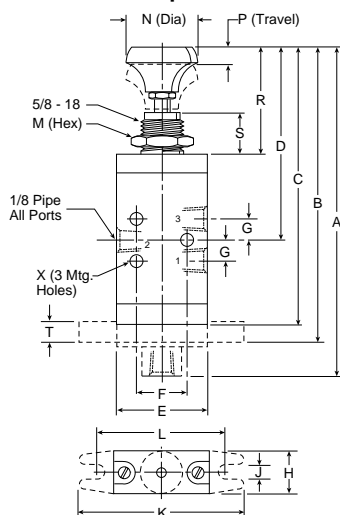

Hand Lever Operated

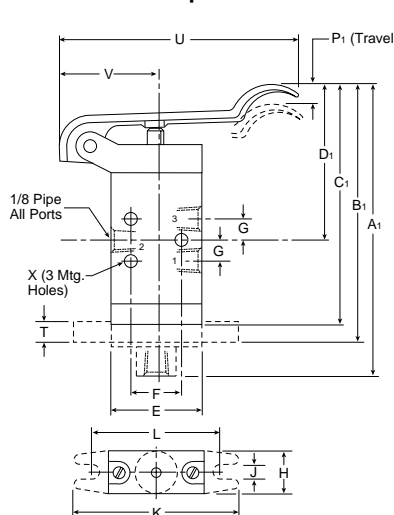

3-Way, 3-Port, 2-Position

A	A1	B	B1	C
5.08 (129)	4.29 (109)	4.55 (115)	3.77 (96)	4.31 (109)
C1	D	D1	E	F
3.53 (90)	3.08 (78)	2.29 (58)	1.31 (33)	.75 (19)
G	H	J	K	L
.31 (8)	.62 (16)	.20 (5)	2.38 (60)	1.88 (48)
M	N	P	P1	R
.88 (22)	1.06 (27)	.17 (4)	.53 (13)	1.67 (42)
S	T	U	V	X
.63 (16)	.25 (6)	3.38 (86)	1.19 (30)	.19 (5)
Y				
.59 (15)				

Inches (mm)



Brass Poppet / Sliding Seal
 LV-EZ Series Lockout Valves
 M0 Series
 Viking Xtreme Lever Series
 42 Lever / Pedal Series
 Directair 2, Directair 4
D
 Manual / Mechanical Valve Products

Plunger, Roller, One-way Tripper & Toggle Operated — 4-Way, 5-Port, 2-Position – 1/8" Ports

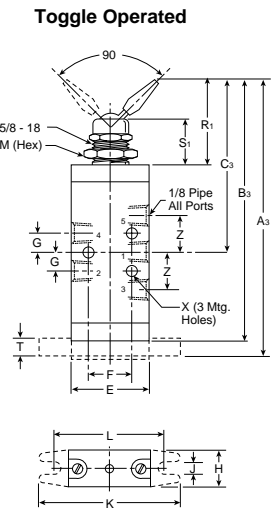
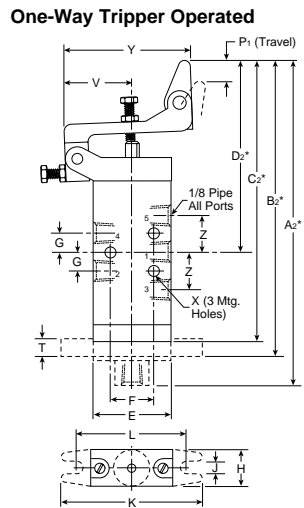
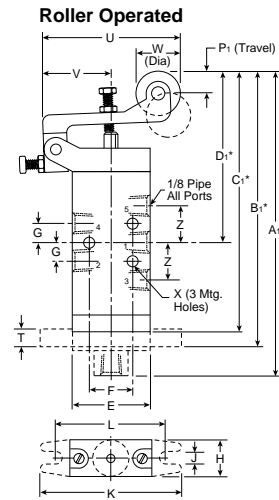
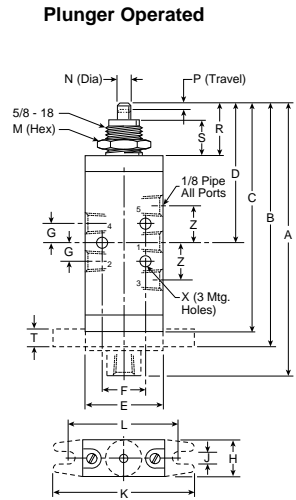

4-Way, 5-Port, 2-Position

A 4.75 (121)	A1* 5.59 (142)	A2* 5.84 (148)	A3 4.84 (123)	B 4.22 (107)
B1* 5.06 (128)	B2* 5.31 (135)	B3 4.61 (117)	C 3.99 (102)	C1* 4.83 (123)
C2* 5.08 (129)	C3 3.06 (78)	D 2.44 (62)	D1* 3.28 (83)	D2* 3.53 (90)
E 1.31 (33)	F .75 (19)	G .31 (8)	H .62 (16)	J .20 (5)
K 2.38 (60)	L 1.88 (48)	M .88 (22)	N .25 (6)	P .17 (4)
P1 .38 (10)	R .91 (23)	R1 1.53 (39)	S .62 (16)	S1 .78 (20)
T .25 (6)	U 2.28 (58)	V 1.19 (30)	W .75 (19)	X .19 (5)
Y 2.19 (56)	Z .62 (16)			

* Dimensions may be reduced .44" using adjusting screw.
 Inches (mm)

Button & Hand Lever Operated — 4-Way, 5-Port, 2-Position – 1/8" Ports

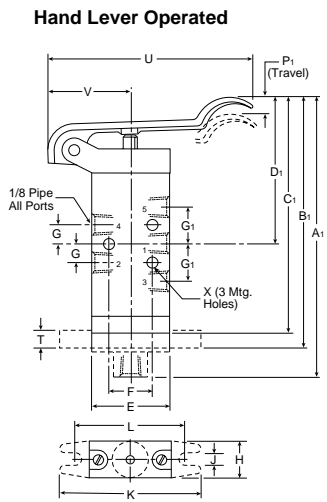
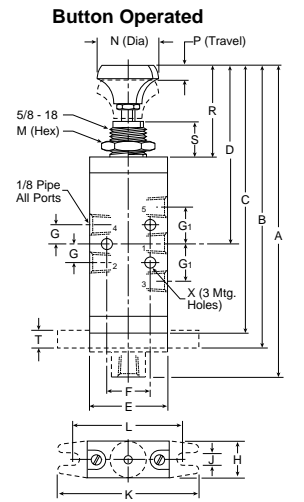

4-Way, 5-Port, 2-Position

A 5.69 (144)	A1 4.90 (124)	B 5.16 (131)	B1 4.38 (111)	C 4.92 (125)
C1 4.14 (105)	D 3.67 (93)	D1 2.90 (74)	E 1.31 (33)	F .75 (19)
G .31 (8)	G1 .63 (16)	H .62 (16)	J .20 (5)	K 2.38 (60)
L 1.88 (48)	M .88 (22)	N 1.06 (27)	P .17 (4)	P1 .53 (13)
R 1.67 (42)	S .63 (16)	T .25 (6)	U 3.38 (86)	V 1.19 (30)
X .19 (5)	Y .59 (15)			

Inches (mm)



Brass Poppet / Sliding Seal

LV-EZ Series Lockout Valves

M0 Series

Viking Xtreme Lever Series

42 Lever / Pedal Series

Directair 2, Directair 4

D
 Manual / Mechanical Valve Products

Button & Roller Operated — 3-Way, 3-Port, 2-Position

Button Operated

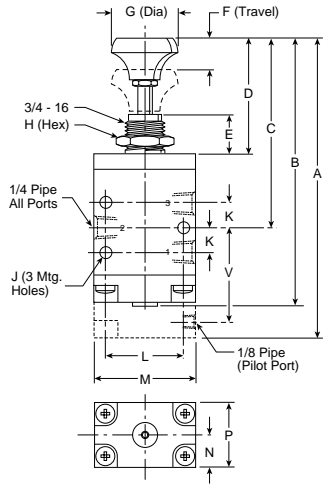

Roller Operated

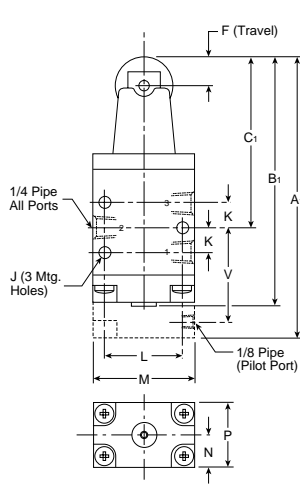

3-Way, 3-Port, 2-Position

A	A ₁	B	B ₁	C
4.91 (125)	4.25 (108)	4.44 (113)	3.78 (96)	3.10 (79)
C ₁	D	E	F	G
2.44 (62)	2.00 (51)	.63 (16)	.32 (8)	1.05 (27)
H	J	K	L	M
1.00 (25)	.19 (5)	.41 (10)	1.25 (32)	1.63 (42)
N	P	V		
.53 (14)	1.06 (27)	1.52 (39)		

Inches (mm)

Lever & Pedal Operated — 3-Way, 3-Port, 2 & 3-Position

**Lever Operated
2-Position**

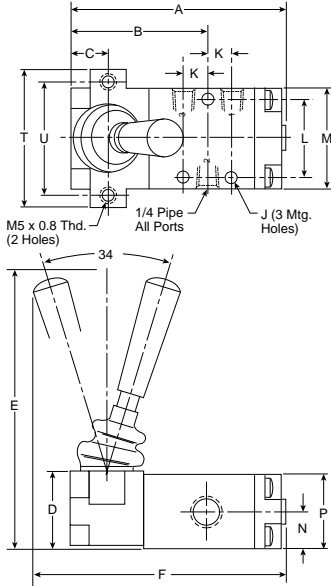

**Lever Operated
3-Position**

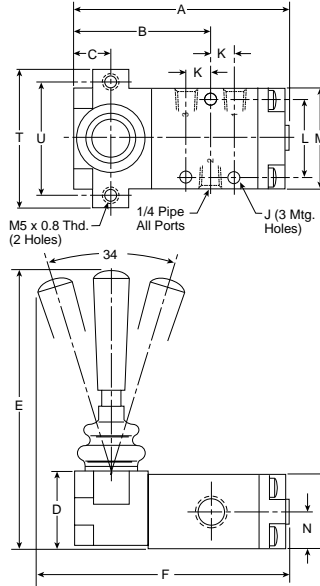

3-Way, 3-Port, 2 & 3-Position

A	A ₁	B	B ₁	C
3.31 (84)	6.55 (166)	1.97 (50)	5.20 (132)	.53 (14)
C ₁	D	E	F	J
2.19 (56)	1.12 (28)	4.06 (103)	3.90 (99)	.19 (5)
K	L	M	N	P
.41 (10)	1.25 (32)	1.63 (42)	.53 (14)	1.06 (27)
Q	R	S	T	T ₁
.37 (10)	2.40 (61)	.34 (9)	2.13 (54)	3.50 (89)
U	U ₁			
1.75 (44)	3.00 (76)			

Inches (mm)

Pedal / Treadle Operated

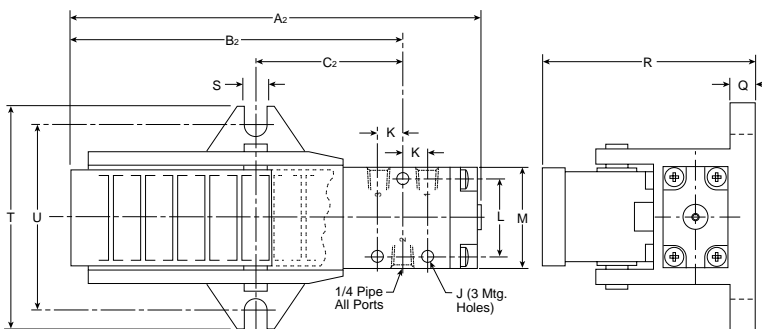

CAUTION:

This valve shall not be used to actuate a punch press. Do not use this valve on punch presses or press brakes. See OSHA 1910.217.



Brass Poppet / Sliding Seal
 LV-EZ Series Lockout Valves
 M0 Series
 Viking Xtreme Lever Series
 42 Lever / Pedal Series
 Directair 2, Directair 4
D
 Manual / Mechanical Valve Products

Button, Roller, Pedal & Treadle, Lever Operated — 4-Way, 5-Port, 2-Position

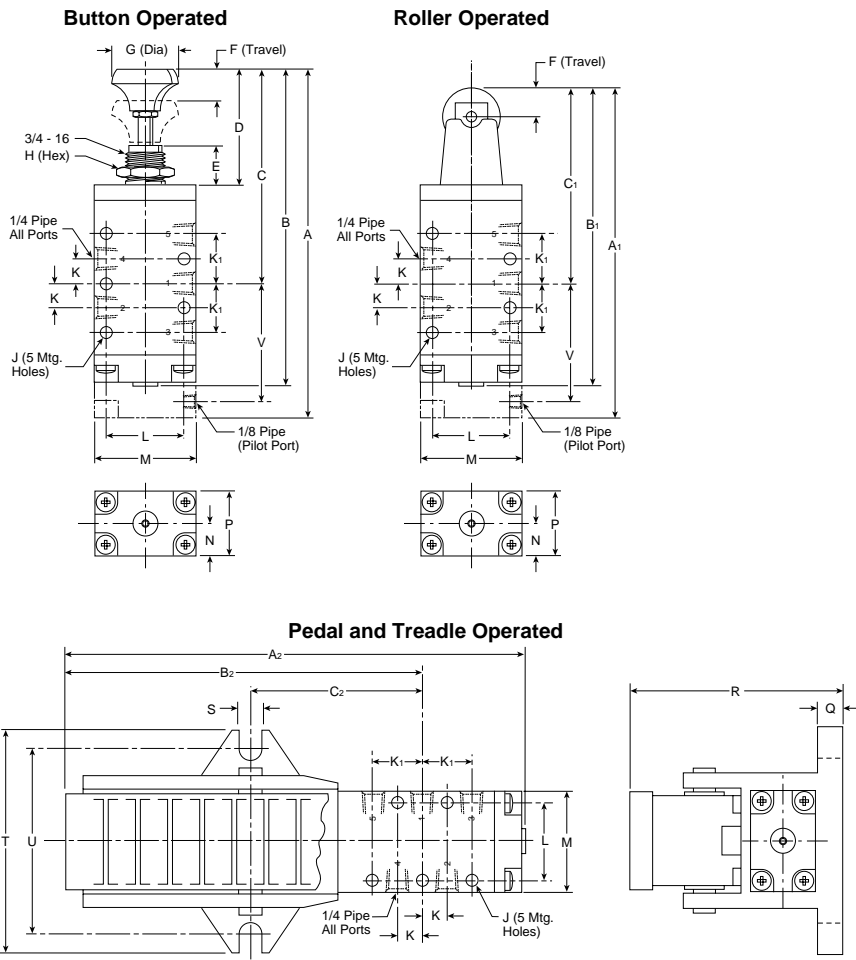

4-Way, 5-Port, 2-Position

A	A₁	A₂	B	B₁
5.75 (146)	5.13 (130)	7.41 (189)	5.28 (134)	4.66 (118)
B₂	C	C₁	C₂	D
5.63 (143)	3.50 (89)	2.88 (73)	2.64 (67)	2.00 (51)
E	F	G	H	J
.63 (16)	.32 (8)	1.05 (27)	1.00 (25)	.19 (5)
K	K₁	L	M	N
.44 (11)	.84 (21)	1.25 (32)	1.63 (41)	.53 (14)
P	Q	R	S	T
1.06 (27)	.37 (10)	2.40 (61)	.34 (9)	3.50 (89)
U	V			
3.00 (76)	1.96 (50)			

Inches (mm)

! CAUTION:
 This valve shall not be used to actuate a punch press.
 Do not use this valve on punch presses or press brakes.
 See OSHA 1910.217.

Lever Operated — 4-Way, 5-Port, 2 & 3-Position

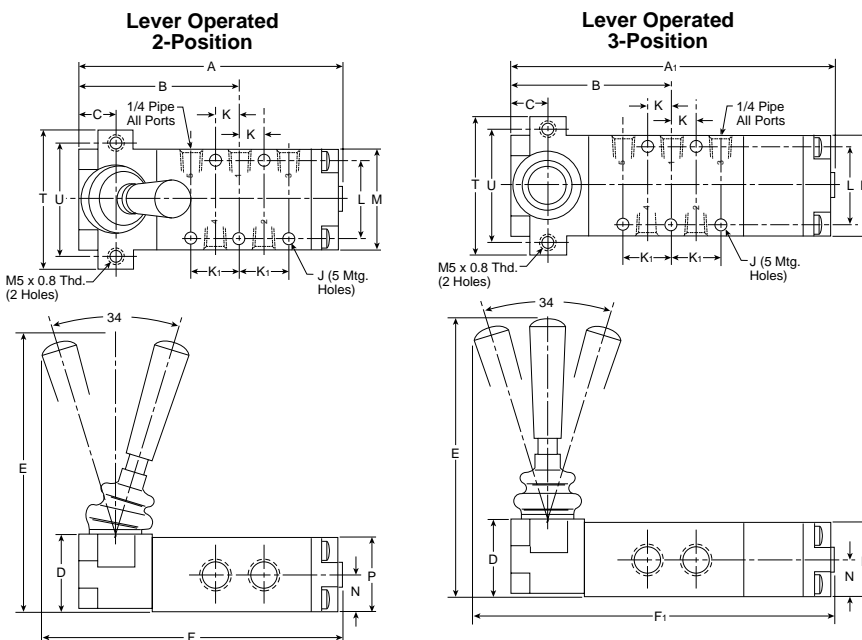

4-Way, 5-Port, 2 & 3-Position

A	A₁	B	C	D
4.19 (106)	5.09 (129)	2.41 (61)	.53 (14)	1.12 (28)
E	F	F₁	J	K
4.06 (103)	4.78 (121)	5.78 (147)	.19 (5)	.44 (11)
K₁	L	M	N	P
.84 (21)	1.25 (32)	1.63 (42)	.53 (14)	1.06 (27)
T	U			
2.13 (54)	1.75 (44)			

Inches (mm)



Brass Poppet/
Sliding Seal

LV-EZ Series
Lockout Valves

M0
Series

Viking Xtreme
Lever Series

42 Lever/
Pedal Series

Directair 2,
Directair 4

D
Manual / Mechanical
Valve Products