

# Pneumatic cylinders

**Series P1C**

**According to ISO, VDMA and AFNOR**

Catalogue 9127006862GB-ul



<b>Contents</b>	<b>Page</b>
General information .....	3-5
P1C, main data .....	6-7
Ordering information .....	8
Cylinder with Factory Fitted Valve .....	9
Cylinder with Piston Rod Locking Device .....	10
Cylinder with Rod Guidance Modules .....	11
Ordering information, special versions .....	12-13
Cylinder dimensions .....	14-17
Mountings .....	18-29
Sensors .....	30-32
Valvetronic .....	33
Ready-to-use Cables .....	34
Maintenance .....	35



#### **Important**

Before attempting any external or internal work on the cylinder or any connected components, make sure the cylinder is vented and disconnect the air supply in order to ensure isolation of the air supply.



#### **Note**

**Air quality is essential for maximum cylinder service life (see ISO 8573).**

#### **Note**

**All technical data in this catalogue are typical data only.**

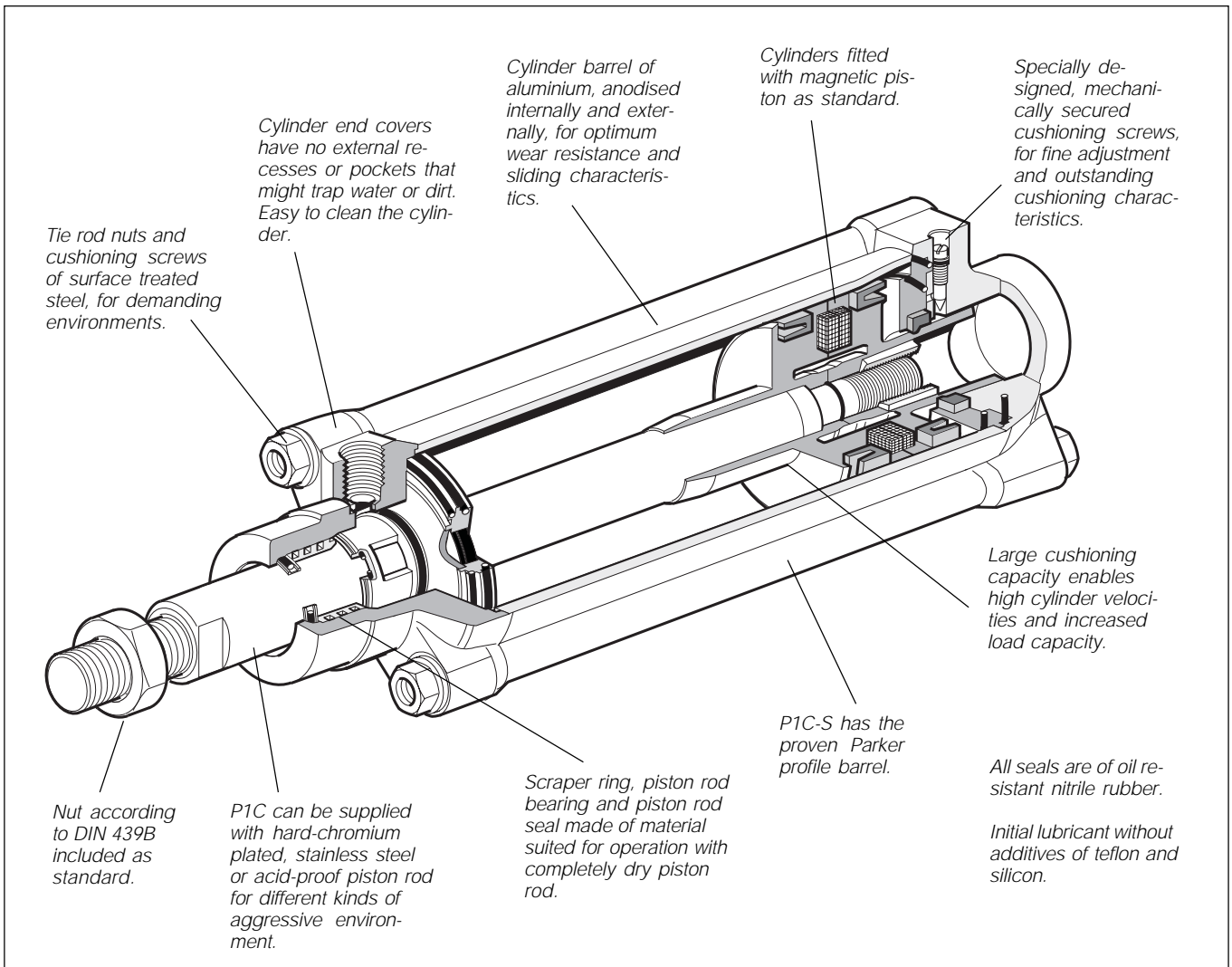

**P1C cylinders**

The Parker P1C series cylinders are available as smooth profile or tie rod versions, both based upon the same internal design principle.

Both types are double acting with adjustable end cushioning and available in bore sizes 32 to 125mm with standard strokes up to 500mm.

**Standardised installation dimensions**

The P1C series conforms fully with ISO6431, VDMA24562 and AFNOR installation dimensions.

**Quality**

Parker Pneumatic meets the Quality Assurance standards of ISO9001, and is certified by Det Norske Veritas

This ensures quality starts with the design brief and remains top priority throughout the design stages as well as in planning, purchasing, production, distribution and service.

**Adaptability for use with electronics**

The cylinders incorporate magnetic pistons as standard for proximity position sensing. A full range of sensors is available enabling the cylinders to be integrated into the most advanced automation systems. The sensors can be fitted at any position along the cylinder barrel.

**Design**

In the development of P1C cylinders, great emphasis was placed on the importance of long service life particularly for applications in demanding environments. This involved the use of corrosion resistant materials together with clean external design, efficient cushioning and effective bearings and seals for operation with a dry piston rod.

**Long service life**

The use of proven sealing systems and pre-lubricated bearings together with surface finish and fine tolerances ensure long, safe and reliable service life.

## Effective cushioning

The long cushioning length and simple cushioning screw enable a large mass, high velocity, short cycle time with fine adjustment.

## Dry operation

The design of the cylinder makes it ideal for applications demanding hygiene and regular cleaning.

Use of pre-lubricated materials together with the design of piston rod bearing, scraper and seal enable regular wiping/de-greasing of the piston rod without jeopardising the service life.

## Clean external design

The end plates of P1C cylinders have no recesses or cavities. This prevents retention of dirt or liquids and enables simple and effective cleaning.

## Corrosion resistance

The selection of materials and surface treatments ensure that even standard versions of the P1C cylinder have good corrosion resistance and make them suitable for applications in demanding environments.

## Options

In addition to the standard version, the P1C cylinder is available with a number of special options designed to meet more exacting needs and functions, these include:

- Non standard stroke lengths
- Choice of piston rod materials
- Extended piston rods
- Through piston rod
- External guidance modules
- Piston rod locking device
- Complete assembly with control valve
- High temperature
- Low temperature
- Low pressure hydraulic
- Duplex

## Position sensing

A complete range of reed and solid state sensors with either flying leads or connector plugs are available for piston position sensing.

## Mountings

A complete range of surface treated mountings conforming to ISO, VDMA and AFNOR are available.

Double acting, smooth profile.

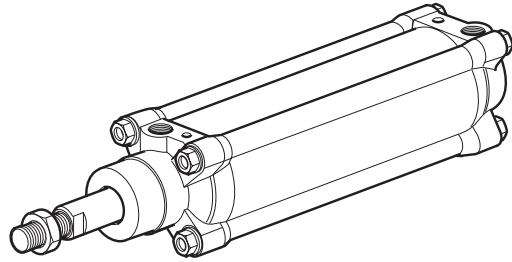

Double acting with tie rods

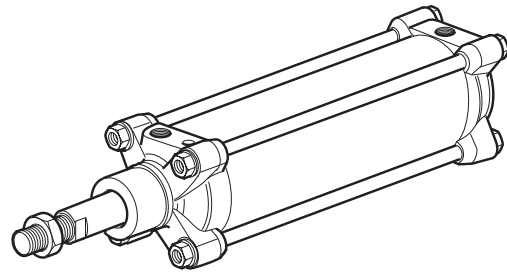

Double acting with a mounted valve

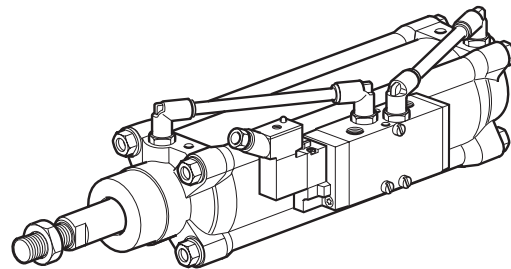

Double acting with piston-rod locking device

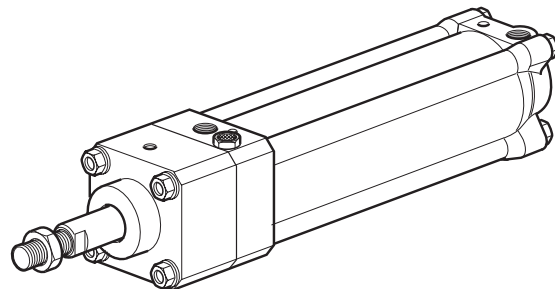

### Special options

Using the P1C cylinders as the basic equipment, a number of special cylinders can be created to suit different demands.

#### Piston rod material

All P1C cylinders are available with the following piston rod materials:

- Hard-chromium plated piston rod (Fe 490-2 FN)
- Stainless steel piston rod\* (X 10 CrNiS 18 9)
- Acid-proof piston rod\* (X 5 CrNiMo 17 13 3)
- Hard-chromium plated stainless steel piston rod (X 10 CrNiS 18 9)

See order key, page 8.

\* With roller polished surface.

#### Through piston rod

All P1C cylinders can be supplied with through piston rod. See order key, page 8.

#### Low ambient temperatures

P1C cylinders can be supplied with special seals and grease to enable use in low ambient temperatures.

Temperature range  $-40\text{ }^{\circ}\text{C}$  to  $+40\text{ }^{\circ}\text{C}$ .

Please note that proximity position sensing and dry piston rod operation are not possible to combine with this option.

See order key, page 8.

#### High ambient temperatures

P1C cylinders can be supplied with special seals and grease to enable use in high ambient temperatures.

Temperature range  $-10\text{ }^{\circ}\text{C}$  to  $+150\text{ }^{\circ}\text{C}$ .

Please note that proximity position sensing and dry piston rod operation are not possible to combine with this option.

See order key, page 8.

#### Low pressure hydraulic

P1C cylinders can be supplied with special seals to enable use with low pressure oil up to maximum pressure of 10 bar.

Temperature range,  $-20\text{ }^{\circ}\text{C}$  to  $+80\text{ }^{\circ}\text{C}$ .

#### Duplex cylinders

P1C cylinders can be supplied as 'back to back' duplex, 3 or 4 position cylinders.

The P1C-T type is supplied fully assembled, please contact the Technical Sales Department.

The P1C-S type up to 100 mm bore can be assembled using the mounting kit shown on page 22 and 29.

Double acting with through piston rod

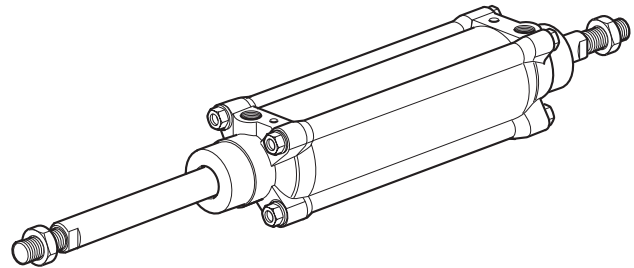

Double acting 3 and 4 position cylinders

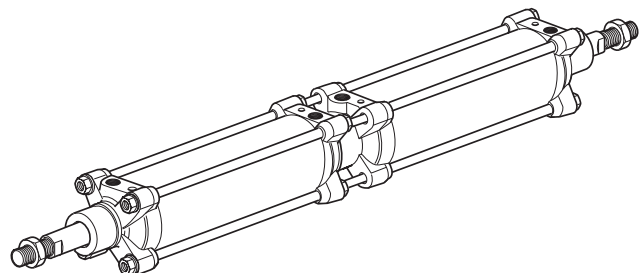

## Main data: P1C

Cylinder designation	Cylinder		Piston rod			Cushioning length	Total mass		Mass, moving parts		Air consumption <sup>2)</sup>	Port size
	bore	area	diam.	area	thread		at 0 mm stroke length	Addition per 10 mm stroke	at 0 mm stroke length	Addition per 10 mm stroke		
	mm	cm <sup>2</sup>	mm	cm <sup>2</sup>		mm	kg	kg	kg	kg	litre	
P1C-S032MS-S <sup>1)</sup>	32	8,0	12	1,1	M10x1,25	20	0,48	0,023	0,13	0,009	0,105	G1/8
P1C-S040MS-S <sup>1)</sup>	40	12,6	16	2,0	M12x1,25	22	0,66	0,032	0,24	0,016	0,162	G1/4
P1C-S050MS-S <sup>1)</sup>	50	19,6	20	3,1	M16x1,5	22	1,09	0,051	0,42	0,025	0,253	G1/4
P1C-S063MS-S <sup>1)</sup>	63	31,2	20	3,1	M16x1,5	29	1,45	0,058	0,50	0,025	0,414	G3/8
P1C-S080MS-S <sup>1)</sup>	80	50,3	25	4,9	M20x1,5	24	2,70	0,080	1,12	0,039	0,669	G3/8
P1C-S100MS-S <sup>1)</sup>	100	78,5	25	4,9	M20x1,5	29	3,78	0,093	1,43	0,039	1,043	G1/2
P1C-S125MS-S <sup>1)</sup>	125	122,7	32	8,0	M27x2	32	6,69	0,137	2,94	0,063	1,662	G1/2
P1C-T032MS-S <sup>1)</sup>	32	8,0	12	1,1	M10x1,25	20	0,45	0,022	0,13	0,009	0,105	G1/8
P1C-T040MS-S <sup>1)</sup>	40	12,6	16	2,0	M12x1,25	22	0,64	0,032	0,24	0,016	0,162	G1/4
P1C-T050MS-S <sup>1)</sup>	50	19,6	20	3,1	M16x1,5	22	1,03	0,049	0,42	0,025	0,253	G1/4
P1C-T063MS-S <sup>1)</sup>	63	31,2	20	3,1	M16x1,5	29	1,37	0,052	0,50	0,025	0,414	G3/8
P1C-T080MS-S <sup>1)</sup>	80	50,3	25	4,9	M20x1,5	24	2,56	0,080	1,12	0,039	0,669	G3/8
P1C-T100MS-S <sup>1)</sup>	100	78,5	25	4,9	M20x1,5	29	3,63	0,085	1,43	0,039	1,043	G1/2
P1C-T125MS-S <sup>1)</sup>	125	122,7	32	8,0	M27x2	32	6,43	0,121	2,94	0,063	1,662	G1/2

1) Stroke length

2) Free air consumption per 10 mm stroke length for a double stroke at 6 bar

## Material specifications

## Standard version:

Cylinder barrel	Natural anodised aluminium
End covers	Black anodised aluminium
End-cap inserts, Ø32-Ø63	POM plastic
End-cap nuts/screws	Surface treated steel 8.8
Tie rods for P1C-T	Stainless steel, X 10 CrNiS 18 9
Piston rod P1C-T, Ø32-Ø63	Stainless steel, X 10 CrNiS 18 9
Piston rod P1C-T, Ø80-Ø125	Hard-chromium plated steel, Fe 490-2 FN
Piston rod P1C-S, Ø32-Ø125	Stainless steel, X 10 CrNiS 18 9
Scraper ring	UHMWPE plastic
Piston-rod bearing, Ø32-Ø63	POM plastic
Piston-rod bearing, Ø80-Ø125	UHMWPE plastic
Piston-rod seal	UHMWPE plastic
Piston, Ø32-Ø63	POM plastic
Piston, Ø80-Ø125	Anodised aluminium
Piston bearing, Ø32-Ø63	POM plastic
Piston bearing, Ø80-Ø125	UHMWPE plastic
Magnetic ring/band	Plastic bonded magnetic material
Piston nut	Zinc plated steel
Piston seals	Nitrile rubber, NBR
O-rings	Nitrile rubber, NBR
Cushioning rings	Nitrile rubber, NBR
Cushioning screws	Stainless steel
Cushioning-screw lock washers	Stainless steel

## Other data

Working medium	dry, filtered compressed air
Working pressure	max 10 bar
Working temperature	max +80 °C min -20 °C
High temperature version	max +150 °C min -10 °C
Low temperature version	max +40 °C min -40 °C

## Material specifications

## Special options:

## Low-temperature version

Seals/scraper ring	Nitrile rubber, NBR
End-cap inserts, Ø32-Ø63	Aluminium
Piston, Ø32-Ø125	Anodised aluminium
Piston-/piston-rod bearing	UHMWPE plastic

## High-temperature version

Seals/scraper ring	Fluorocarbon rubber, FPM
End-cap inserts, Ø32-Ø63	Aluminium
Piston, Ø32-Ø125	Anodised aluminium
Piston-/piston-rod bearing	Bronze-filled PTFE

## Low pressure hydraulic

Seals	Nitrile rubber, NBR
Scraper ring	Polyurethane
End-cap inserts, Ø32-Ø63	Aluminium
Piston, Ø32-Ø125	Anodised aluminium
Piston-/piston-rod bearing	UHMWPE plastic

## Piston forces

The values for piston forces are theoretical, and should be reduced in accordance with the working conditions.

Cylinder designation	Cylinder bore	Theoretical piston force at 6 bar	
		plus stroke	minus stroke
	mm	N	N
P1C-•032••-XXXX <sup>1)</sup>	32	482	414
P1C-•040••-XXXX <sup>1)</sup>	40	754	633
P1C-•050••-XXXX <sup>1)</sup>	50	1178	989
P1C-•063••-XXXX <sup>1)</sup>	63	1870	1681
P1C-•080••-XXXX <sup>1)</sup>	80	3016	2721
P1C-•100••-XXXX <sup>1)</sup>	100	4712	4417
P1C-•125••-XXXX <sup>1)</sup>	125	7363	6880

1) XXXX = stroke

• = option, as in order key

**Cushioning diagram**

Use the diagram below to determine the necessary size of cylinder to provide the requisite cushioning performance. The maximum cushioning performance, as indicated in the diagram, is based on the following assumptions:



- Low load, i.e. low pressure drop across the piston
- Steady-state piston speed

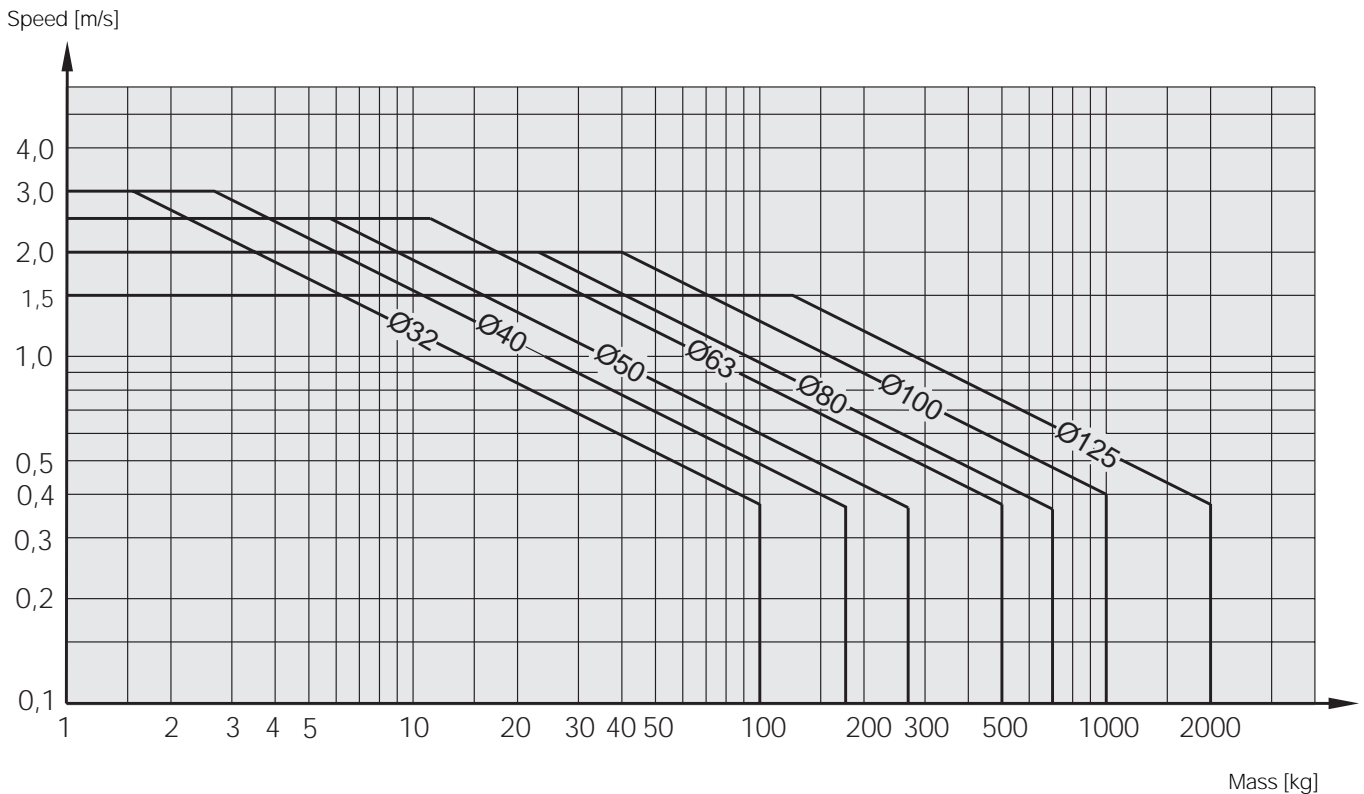

The load is the sum of the internal and external friction, together with any gravity forces. At high relative loading it is recommended that, for a given speed, the load should be reduced by a factor of 2.5, or that, for a given mass, the speed should be reduced by a factor of 1.5. These factors apply in relation to the maximum performance as shown in the diagram.



Order key, standard version

**P1C - S**      **032**      **M**      **S**      -      **0100**

Cylinder type, smooth profile	
<b>S</b>	 Standard version.
<b>L</b>	 Piston rod lock device. With hard chromium plated piston rod only.
<b>C</b>	Standard version with factory-fitted centre trunnion. Pivots turned 90° to ports. Other XV measure than centre see page 12.
<b>A</b>	Combination of C+L

Cylinder type, traditional tie rods	
<b>T</b>	 Standard version
<b>M</b>	 Piston rod lock device. With hard chromium plated piston rod only.
<b>D</b>	Standard version with factory fitted central trunnion as "C" above.
<b>E</b>	Combination of D+M

Cylinder type/Function		
Single rod	Through rod	
<b>M</b>	<b>F</b>	Standard version
<b>A</b>	<b>G</b>	End cover screws in stainless steel with internal thread in both covers
<b>B</b>	<b>J</b>	End cover screws in stainless steel with internal thread in rear cover, without internal thread in front cover
<b>C</b>	*	End cover screws in stainless steel with internal thread in front cover, without internal thread in rear cover
*	*	Cylinder with aluminium piston for Ø32-Ø63
*		Scraper ring of stainless steel

Stroke in mm	
E.g. <b>0100</b> = 100 mm	
For standard stroke length and max length, see table below	

Options	
-	None
<b>A</b>	"H profile" rod guide module with ball bearing
<b>B</b>	"H profile" rod guide module with plain bearing
<b>C</b>	"U profile" rod guide module with plain bearing
*	End covers and barrel, Epoxy painted

Cylinder bore mm	
<b>032</b>	
<b>040</b>	
<b>050</b>	
<b>063</b>	
<b>080</b>	
<b>100</b>	
<b>125</b>	

Material piston rod		Type of sealing		
Stainless steel	Hard chromed steel	Acid-proof steel	Chromed stainl. steel	
<b>S</b>	<b>C</b>	*	*	Standard -20 °C to +80 °C.
<b>F</b>	<b>G</b>	*	*	High temperature version -10 °C to +150 °C. Non magnet.
<b>L</b>	<b>K</b>	*	*	Low temperature version -40 °C to +40 °C. Non magnet.
	<b>J</b>	*		Low pressure hydraulic.

**\* For this option contact customer service for more information.**

Standard stroke length in mm

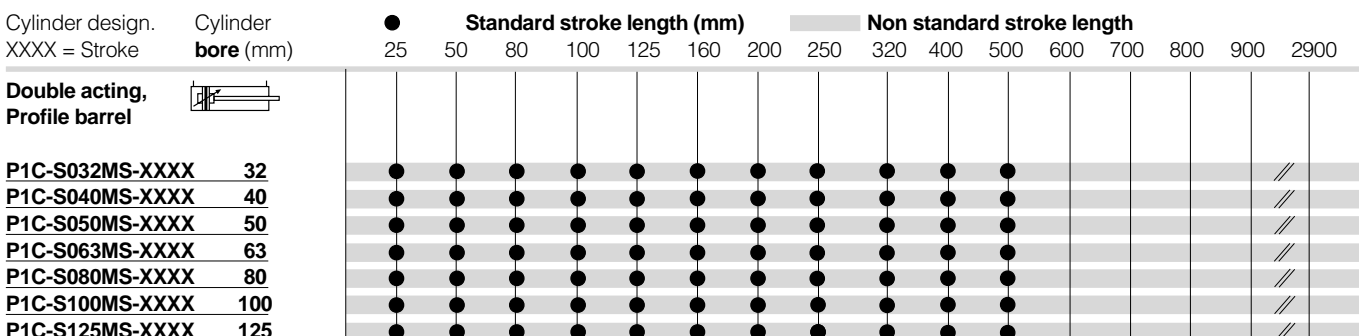



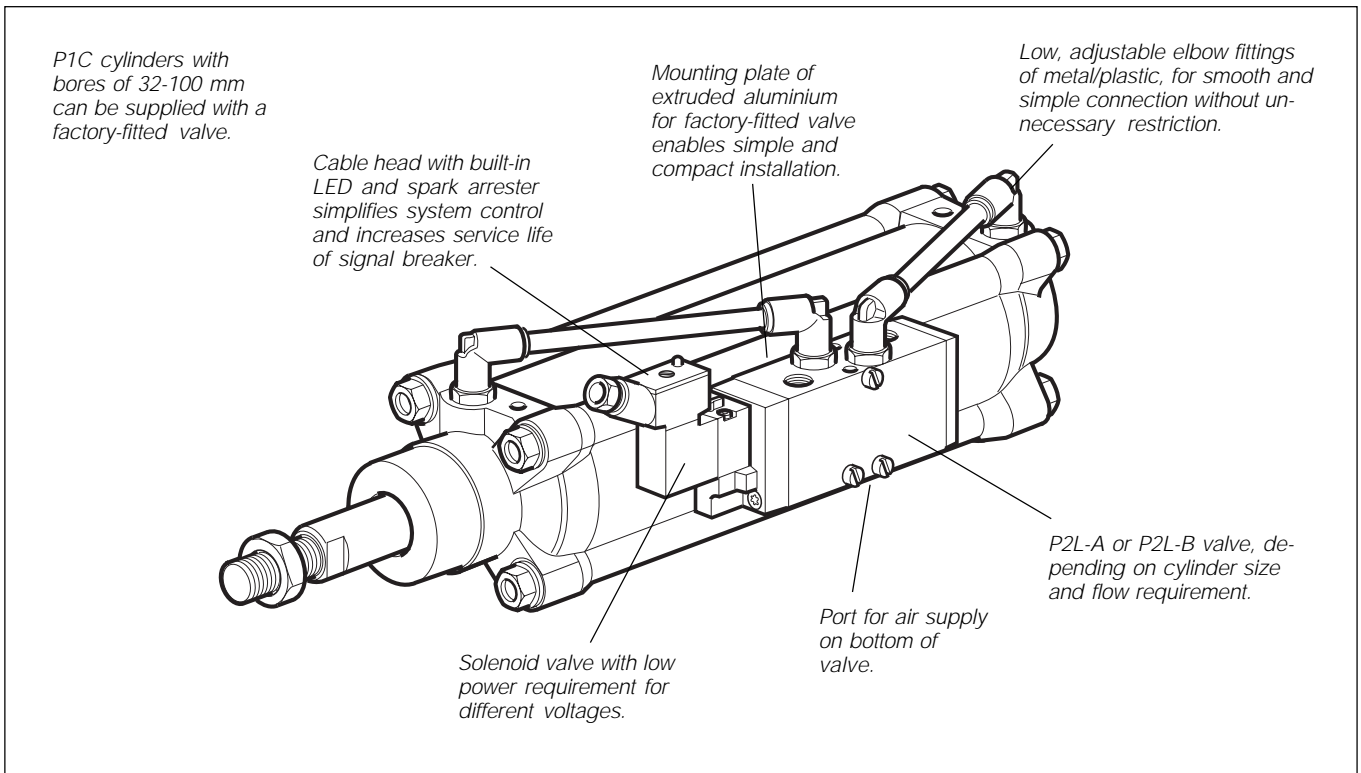

**Complete working unit**

The P1C series cylinders, 32 to 100mm bore sizes, are available complete with factory fitted control valve.

The valve, type P2L-A or P2L-B depending upon cylinder size, is securely attached to the cylinder profile barrel by means of a mounting plate and includes the valve to cylinder pipework.

Installation of the cylinder assembly into the application is completed by use of standard ISO/VDMA mountings together with cable connections and mains air supply.

**Fast response**

The short distance between valve and cylinder enable fast response and minimum air consumption.

**Maintenance free and easy to service**

The complete assembly comprises standard components, with both valve and cylinder suitable for use without additional airline lubrication.

**Many applications**

The compact assembly enables use in confined spaces and applications where fast activation is important.

This includes applications where the cylinder is remotely located, for example silo plants, damper and process valve actuation and many similar installations.

**Solenoid valve voltage**

24 V UC (24 V DC/AC, Universal Current)  
115 V/50 Hz, 120 V/60 Hz  
230 V/50 Hz, 240 V/60 Hz

**Order specifications for complete unit, see pages 12 and 13**

**Technical data**

Working pressure	max 10 bar
Working medium	dry, filtered compressed air
Working temperature	-20 °C to +70 °C (-15 °C to +60 °C with solenoid valve)
Flow, P2L-A, acc. to ISO 6358	C=3,0 NI/s, bar, b= 0,3
Flow, P2L-B, acc. to ISO 6358	C=4,2 NI/s, bar, b=0,2
Power consumption, solenoid	Inrush                      Hold
P2E-KV32C1, 24 V DC	1,2 W                      1,2 W
P2E-KV31C1, 24 V AC	3,5 VA                    1,6 VA

**Material specification**

P1C cylinders	see page 6.
P2L-A and P2L-B valves	
Valve body and end covers	Anodised aluminium
See also catalogue: 9127007722GB-ul	
P2E-•V solenoid valves	
Body, coil casing	Thermoplastic
Coil	Epoxy moulded
See also catalogue: 9127007722GB-ul	
Mounting plate	Anodised aluminium
Mounting screws for plate	Stainless steel
Mounting screws for valve	Zinc-plated steel
Elbow fittings	Nickel-plated brass/plastic

**Accessories**

Designation	Order code
Silencer (Siflow) for P2L-A valve, G1/8	<b>9301050901</b>
Silencer (sintered plastic) for P2L-A valve, G1/8	<b>P6M-PAB1</b>
Silencer (Siflow) for P2L-B valve, G1/4	<b>9301050902</b>
Silencer (sintered plastic) for P2L-B valve, G1/4	<b>P6M-PAB2</b>
Mounting plate P2L-A P1C-S Ø32, Ø40	<b>9122520050</b>
Mounting plate P2L-A P1C-S Ø50, Ø63	<b>9122520051</b>
Mounting plate P2L-A P1C-S Ø80	<b>9122520052</b>
Mounting plate P2L-B P1C-S Ø50, Ø63	<b>9122520053</b>
Mounting plate P2L-B P1C-S Ø80, Ø100	<b>9122520054</b>

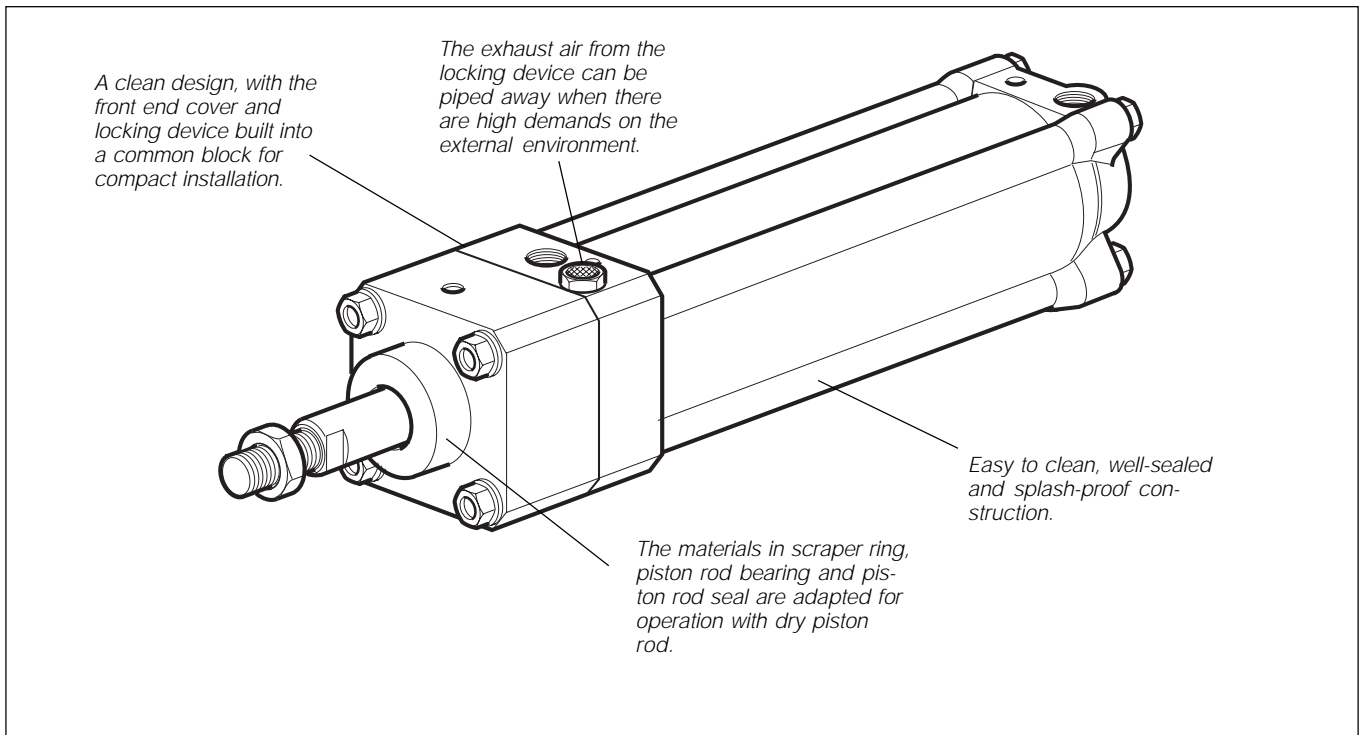

### P1C with piston rod locking device

The P1C-L and P1C-M series cylinders are equipped with a powerful piston rod locking device, which enables the piston rod to be locked in any position. The locking device is of the air/spring activated type, and is integrated into the front end cover of the cylinder.

In the absence of signal pressure, full holding force is applied to the piston rod. The locking device is released at a signal pressure of 4 bar.

The locking device is available for cylinder bores from 32 to 125 mm. The design of P1C cylinders gives several valuable characteristics, such as:

- A holding force corresponding to a pressure of 7 bar.
- A clean design, with the front end cover and locking device built into a common block for compact installation.
- Easy to clean, well-sealed and splash proof construction.
- The exhaust air from the locking device can be piped away when there are high demands on the external environment.
- Complete range of fittings.
- The design of the rod locking device makes it possible to use it as a brake in different applications.

### Applications

- In material handling systems.
- In positioning.
- In the event of pressure loss, for cylinders with vertically hanging loads. See holding forces.
- Locking of the piston rod during longer controlled stops.

### Connection

The signal air for the locking device can be obtained directly from a mains air supply, or from the air supply serving the valve that controls the cylinder itself. For controlled ON/OFF operation of the locking device, a separate quick-venting valve is used.

### Technical data

Working pressure	max 10 bar
Working medium	dry, filtered compressed air
Working temperature	-20 °C to +80 °C
Locking pressure <sup>1)</sup>	min 4 bar ±10%

1) Signal pressure to connection port on locking device.

### Holding forces

Holding forces at 0 bar signal pressure to locking device.

Cylinder designation	Holding force N
P1C-L032••-XXXX/P1C-M032••-XXXX <sup>1)</sup>	550
P1C-L040••-XXXX/P1C-M040••-XXXX <sup>1)</sup>	860
P1C-L050••-XXXX/P1C-M050••-XXXX <sup>1)</sup>	1345
P1C-L063••-XXXX/P1C-M063••-XXXX <sup>1)</sup>	2140
P1C-L080••-XXXX/P1C-M080••-XXXX <sup>1)</sup>	3450
P1C-L100••-XXXX/P1C-M100••-XXXX <sup>1)</sup>	5390
P1C-L125••-XXXX/P1C-M125••-XXXX <sup>1)</sup>	8425

1) XXXX = stroke

• = option, as in order key

### Material specifications, piston-rod locking device

Housing/end cover	Black anodised aluminium
Locking sleeve/plunger	Hardened steel
Springs	Stainless steel
Seals, O-rings	Nitrile rubber, NBR
Scraper ring	UHMWPE-plastic
Air filter	Brass/sintered bronze

Other data according to respective base cylinder.

**Order specifications, see pages 8 and 12**

NOTE!

The cylinders are supplied with hard-chromium plated piston rod as standard.

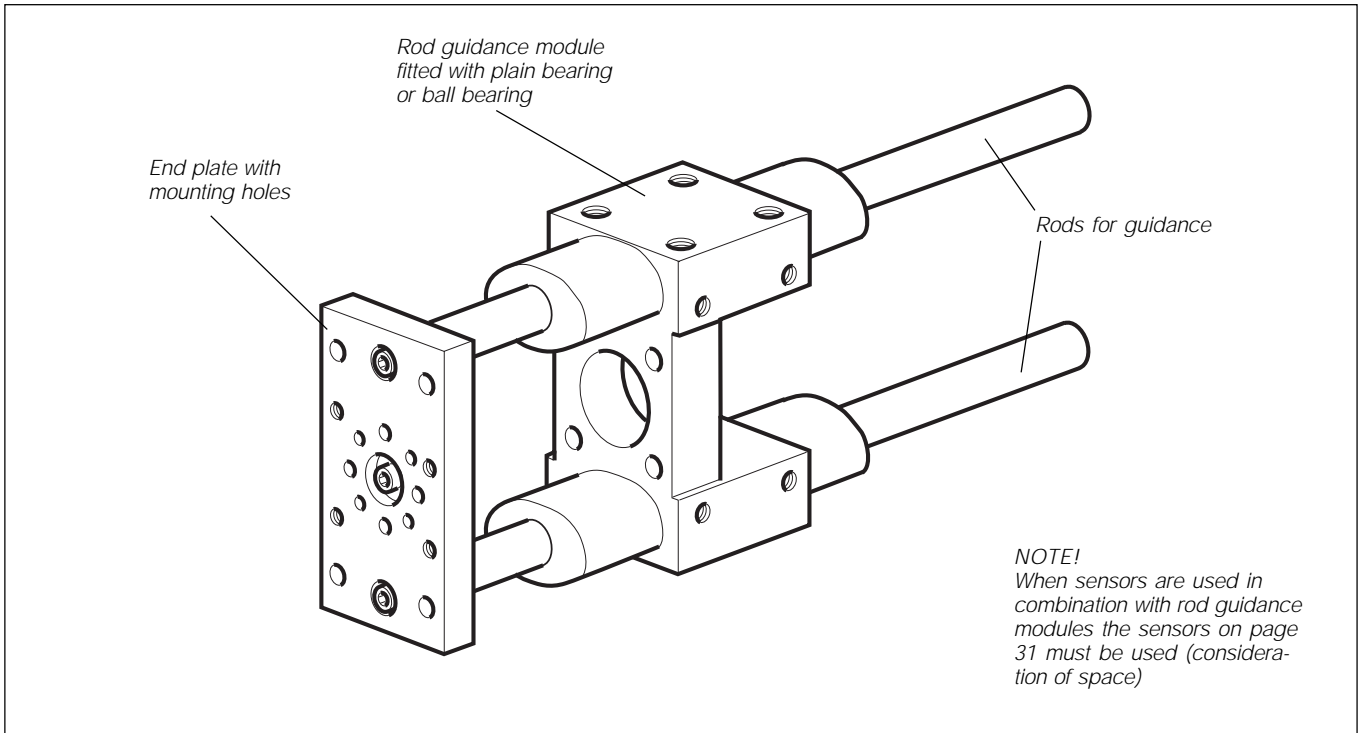

**P1C with rod guidance modules**

The P1C series cylinders can be equipped with an external guiding device to prevent the piston rod from turning. The factory fitted guide gives a guided piston movement and enables the cylinder to take up turning moments on the piston rod, as well as greater transverse forces. The rod guidance is available with plain bearings or linear ball bearings and with H or U style.

The bracket, which has pre-drilled mounting holes, is connected to the piston rod by means of a flexocoupling, which prevents the build-up of stresses in the cylinder.

P1C cylinders with guiding device are available with bores from 32 to 100 mm, and standard stroke lengths from 25 to 250 mm. Special stroke lengths up to 500 mm can also be obtained. Factory-fitting of the guiding device can be specified according to the order key on page 8. Separate guiding device kits can be supplied on request according to the order key below.

**Technical data**

Working pressure max 10 bar  
 Working medium dry, filtered compressed air  
 Working temperature -20 °C to +80 °C

**Material specifications, guidance modules**

Body Anodised aluminium  
 Guide bars, H style Stainless steel for ball bearing  
 chrome plated for plain bearing  
 Front plate Anodised aluminium  
 Guide bars, U style Stainless steel  
 Front plate Zinc-plated steel  
 Bearings Plain bearings  
 Linear ball bearings

Other data as standard cylinder.

**Order specifications for complete unit, see page 8**

**Order key**

<b>P1E</b>		<b>-</b>	<b>4KRH</b>		<b>-</b>	<b>XXXX</b>	
<b>Cylinder version</b>		<b>Bore size mm</b>		<b>Guide module type</b>		<b>Stroke length (mm)</b>	
<b>E</b>	ISO 6431/VDMA cylinders	<b>K</b>	32	<b>H</b>	H style, ball bearings	Same as for the cylinder	
		<b>L</b>	40	<b>J</b>	H style, plain bearings		
		<b>M</b>	50	<b>K</b>	U style, plain bearings		
		<b>N</b>	63				
		<b>P</b>	80				
		<b>Q</b>	100				

Order key, special versions

<b>1</b>	<b>C</b>	<b>S</b>	<b>K</b>	<b>M</b>	<b>S</b>	<b>H95</b>	<b>V</b>	<b>06X</b>	<b>0</b>	<b>0</b>
----------	----------	----------	----------	----------	----------	------------	----------	------------	----------	----------

<b>Cylinder type</b> See page 8.	<b>Cylinder type/ Function</b> See page 8.	<b>Material piston rod/ Type of sealing</b> See page 8.	<b>Factory fitted piston rod mountings</b>																						
<table border="1" style="width: 100%; border-collapse: collapse;"> <tr><th colspan="2">Cylinder bore mm</th></tr> <tr><td><b>K</b></td><td>32</td></tr> <tr><td><b>L</b></td><td>40</td></tr> <tr><td><b>M</b></td><td>50</td></tr> <tr><td><b>N</b></td><td>63</td></tr> <tr><td><b>P</b></td><td>80</td></tr> <tr><td><b>Q</b></td><td>100</td></tr> <tr><td><b>R</b></td><td>125</td></tr> </table>	Cylinder bore mm		<b>K</b>	32	<b>L</b>	40	<b>M</b>	50	<b>N</b>	63	<b>P</b>	80	<b>Q</b>	100	<b>R</b>	125			<table border="1" style="width: 100%; border-collapse: collapse;"> <tr><td><b>0</b></td><td>No mounting</td></tr> <tr><td><b>S</b></td><td>Swivel rod eye</td></tr> <tr><td><b>C</b></td><td>Clevis</td></tr> </table>	<b>0</b>	No mounting	<b>S</b>	Swivel rod eye	<b>C</b>	Clevis
Cylinder bore mm																									
<b>K</b>	32																								
<b>L</b>	40																								
<b>M</b>	50																								
<b>N</b>	63																								
<b>P</b>	80																								
<b>Q</b>	100																								
<b>R</b>	125																								
<b>0</b>	No mounting																								
<b>S</b>	Swivel rod eye																								
<b>C</b>	Clevis																								

<b>Stroke length (mm), E. g. H95=1795</b> For standard and max stroke length see table on page 8.			
<b>0-999</b>	0-999	<b>L00-L99</b>	2000-2099
<b>A00-A99</b>	1000-1099	<b>M00-M99</b>	2100-2199
<b>B00-B99</b>	1100-1199	<b>N00-N99</b>	2200-2299
<b>C00-C99</b>	1200-1299	<b>P00-P99</b>	2300-2399
<b>D00-D99</b>	1300-1399	<b>Q00-Q99</b>	2400-2499
<b>E00-E99</b>	1400-1499	<b>R00-R99</b>	2500-2599
<b>F00-F99</b>	1500-1599	<b>S00-S99</b>	2600-2699
<b>G00-G99</b>	1600-1699	<b>T00-T99</b>	2700-2799
<b>H00-H99</b>	1700-1799	<b>V00-V99</b>	2800-2899
<b>J00-J99</b>	1800-1899	<b>W00-W99</b>	2900-2999
<b>K00-K99</b>	1900-1999		

Option	
<b>N</b>	None
<b>P</b>	Extended piston rod.
<b>V</b>	Cylinder with factory fitted valve.
<b>C</b>	Factory-fitted centre trunnion. Dowels turned 90° to ports.















  

Factory fitted cylinder mountings	
<b>0</b>	No mounting
<b>1</b>	Flange MF1 mounted on front cover
<b>2</b>	Flange MF1/MF2 mounted on front and rear covers
<b>B</b>	Flange MF2 mounted on rear covers
<b>F</b>	Angle brackets MS1
<b>E</b>	Clevis bracket MP4
<b>S</b>	Swivel eye bracket
<b>T</b>	Clevis bracket MP2
<b>L</b>	Clevis brackets MP4 + MP2
<b>P</b>	Clevis bracket MP2 + Pivot bracket

<b>Option P:</b> Extension in mm acc. to stroke length designation E. g. A50=1050 mm.
<b>Option C:</b> XV-dimension in mm acc. to stroke length design. (E75=1475 mm) XV min and max see page 23.
<b>Option V:</b> Type of valve acc. to page 13. Set two letters in box 1 and 2. Voltage to be set in box 3 acc. to table below.
<b>X</b> Air actuated, no solenoid(s)
<b>3</b> 115 V/50 Hz, 120 V/60 Hz, LED+VDR.
<b>4</b> 230 V/50 Hz, 240 V/60 Hz, LED+VDR.
<b>7</b> 24 V UC, LED+VDR (AC/DC Universal Current) Complete with rectifying cable plug.

Order key

<b>Option V: P1C cylinder with factory-fitted valve, (Ø32 - 100)</b>					
<b>P2L-A</b> Ø32 - Ø80	<b>P2L-B</b> Ø50 - Ø100	<b>Symbol</b>	<b>Actuator</b>	<b>Return</b>	<b>Valve type and function</b>
<b>06</b>	<b>17</b>		Air	Air	5/2 Signal pressure min 1,5 bar at 6 bar
<b>07</b>	<b>18</b>		Air	Spring	5/2 Signal pressure min 3,2 bar <sup>1)</sup> , 3,5 bar <sup>2)</sup> at 6 bar
<b>08</b>	<b>19</b>		Air	Self centring Air	5/3 Signal pressure min 3,8bar <sup>1)</sup> , 3,5 bar <sup>2)</sup> at 6 bar Closed centre position
<b>33</b>	<b>55</b>		Air	Self centring Air	5/3 Signal pressure min 3,8bar <sup>1)</sup> , 3,5 bar <sup>2)</sup> at 6 bar Vented centre position
<b>42</b>	<b>56</b>		Air	Self centring Air	5/3 Signal pressure min 3,8 bar <sup>1)</sup> , 3,5 bar <sup>2)</sup> at 6 bar Pressurised centre position
<b>09</b>	<b>20</b>		Electric	Electric	5/2 Internal supply to solenoid valve(s) via port 1
<b>10</b>	<b>21</b>		Electric	Spring	5/2 Internal supply to solenoid valve(s) via port 1
<b>11</b>	<b>57</b>		Electric	Electric	5/2 External supply to solenoid valve(s)
<b>12</b>	<b>22</b>		Electric	Spring	5/2 External supply to solenoid valve(s)
<b>13</b>	<b>23</b>		Electric	Self centring Electric	5/3 Internal supply to solenoid valve(s) via port 1 Closed centre position
<b>14</b>	<b>58</b>		Electric	Self centring Electric	5/3 External supply to solenoid valve(s) Closed centre position
<b>15</b>	<b>25</b>		Electric	Self centring Electric	5/3 Internal supply to solenoid valve(s) via port 1 Vented centre position
<b>16</b>	<b>59</b>		Electric	Self centring Electric	5/3 External supply to solenoid valve(s) Vented centre position
<b>43</b>	<b>24</b>		Electric	Self centring Electric	5/3 Internal supply to solenoid valve(s) via port 1 Pressurised centre position
<b>44</b>	<b>60</b>		Electric	Self centring Electric	5/3 External supply to solenoid valve(s) Pressurised centre position

1) P2L-A valve

2) P2L-B valve

All other data are valid for both sizes of valves.

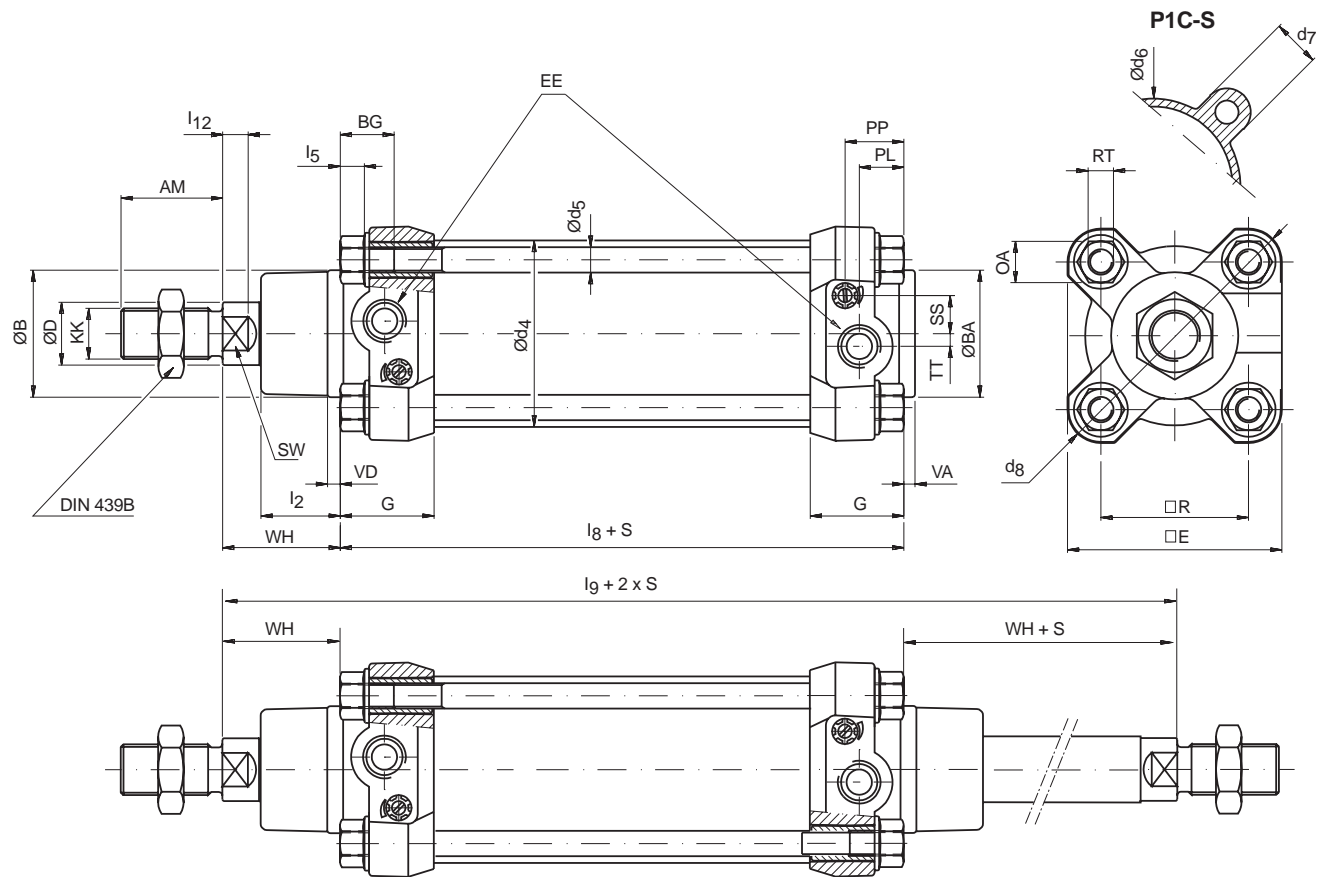

**Dimensions**

Cylinder bore mm	B mm	RT	d <sub>4</sub> mm	d <sub>5</sub> mm	d <sub>6</sub> mm	d <sub>7</sub> mm	d <sub>8</sub> mm	WH mm	l <sub>2</sub> mm	R mm	BG mm	VD mm	VA mm	G mm	l <sub>8</sub> mm	l <sub>5</sub> mm
32	30	M6	36	5,3	36	11	63,5	26	18	32,5	16	4,5	3,5	26	94	5,5
40	35	M6	44	5,3	44	11	71,5	30	18,5	38	16	4,5	3,5	30	105	5,5
50	40	M8	55	7,1	55	15	87	37	25	46,5	16	5	3,5	29,5	106	7,5
63	45	M8	68	7,1	69	15	101	37	25	56,5	16	5	3,5	34,5	121	7,5
80	45	M10	86	8,9	86	17	127	46	32	72	16	4	3,5	35	128	8
100	55	M10	106	8,9	107	17	151	51	36	89	16	4	3,5	40	138	8
125	60	M12	132	10,75	135	20	185	65	46	110	20	6	5,5	44,5	160	9

Cylinder bore mm	E mm	PL mm	PP mm	l <sub>12</sub> mm	SW mm	BA mm	KK	AM mm	EE mm	SS mm	TT mm	OA mm	D mm	l <sub>9</sub> mm
32	50	13	16	6	10	30	M10x1,25	22	G1/8	7	4,5	10	12	146
40	55,5	14	19	6,5	13	35	M12x1,25	24	G1/4	10	5	10	16	165
50	67,5	14	18,5	8	16	40	M16x1,5	32	G1/4	12	4	13	20	180
63	77,5	16	20,5	8	16	45	M16x1,5	32	G3/8	11	7,5	13	20	195
80	97	16,5	22	10	21	45	M20x1,5	40	G3/8	12	6	16	25	220
100	114	19	27	10	21	55	M20x1,5	40	G1/2	14,5	6	16	25	240
125	139	22	30	13	27	60	M27x2	54	G1/2	14,5	6	18	32	290

**Tolerances**

Cylinder bore mm	B	R mm	l <sub>8</sub> mm	l <sub>9</sub> mm	BA mm	Stroke-length tolerance
32	e11	±0,5	±0,4	±2	e11	+1/-0
40	e11	±0,5	±0,7	±2	e11	+1/-0
50	e11	±0,6	±0,7	±2	e11	+1/-0
63	e11	±0,7	±0,8	±2	e11	+1/-0
80	e11	±0,7	±0,8	±3	e11	+1/-0
100	e11	±0,7	±1	±3	e11	+1/-0
125	e11	±1,1	±1	±3	e11	+1/-0

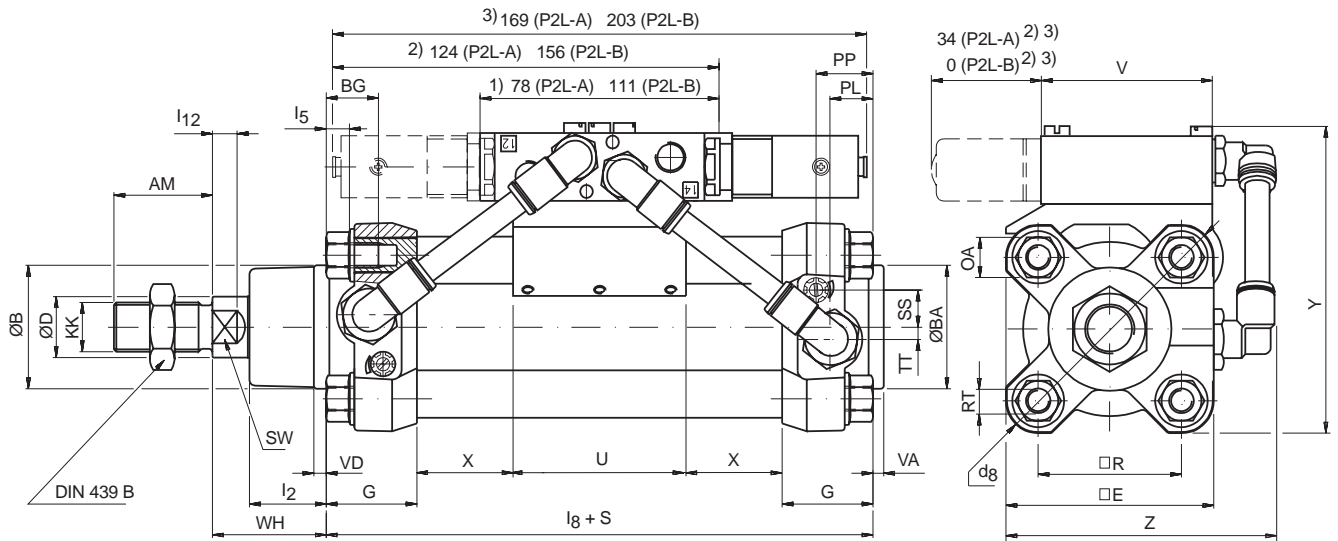

**Dimensions**

Cyl. bore, valve mm	B mm	RT	d <sub>8</sub> mm	WH mm	l <sub>2</sub> mm	R mm	BG mm	VD mm	VA mm	G mm	l <sub>8</sub> mm	l <sub>5</sub> mm	E mm	PL mm	PP mm	l <sub>12</sub> mm
32, P2L-A	30	M6	63,5	26	18	32,5	16	4,5	3,5	26	94	5,5	50	13	16	6
40, P2L-A	35	M6	71,5	30	18,5	38	16	4,5	3,5	30	105	5,5	55,5	14	19	6,5
50, P2L-A	40	M8	87	37	25	46,5	16	5	3,5	29,5	106	7,5	67,5	14	18,5	8
63, P2L-A	45	M8	101	37	25	56,5	16	5	3,5	34,5	121	7,5	77,5	16	20,5	8
80, P2L-A	45	M10	127	46	32	72	16	4	3,5	35	128	8	97	16,5	22	10
50, P2L-B	40	M8	87	37	25	46,5	16	5	3,5	29,5	106	7,5	67,5	14	18,5	8
63, P2L-B	45	M8	101	37	25	56,5	16	5	3,5	34,5	121	7,5	77,5	16	20,5	8
80, P2L-B	45	M10	127	46	32	72	16	4	3,5	35	128	8	97	16,5	22	10
100, P2L-B	55	M10	151	51	36	89	16	4	3,5	40	138	8	114	19	27	10

Cyl. bore, valve mm	SW mm	BA mm	KK mm	AM mm	SS mm	TT mm	OA mm	D mm	U mm	V mm	X mm	Y mm	Z mm
32, P2L-A	10	30	M10X1,25	22	7	4,5	10	12	36	40	3+S/2	81	71
40, P2L-A	13	35	M12X1,25	24	10	5	10	16	36	40	4,5+S/2	87	79
50, P2L-A	16	40	M16X1,5	32	12	4	13	20	56	40	-4,5+S/2	100	91
63, P2L-A	16	45	M16X1,5	32	11	7,5	13	20	56	40	-2+S/2	110	102
80, P2L-A	21	45	M20X1,5	40	12	6	16	25	56	40	1+S/2	130	126
50, P2L-B	16	40	M16x1,5	32	12	4	13	20	56	54	-4,5+S/2	110	91
63, P2L-B	16	45	M16X1,5	32	11	7,5	13	20	56	54	-2+S/2	120	106
80, P2L-B	21	45	M20X1,5	40	12	6	16	25	56	54	1+S/2	138	126
100, P2L-B	21	55	M20X1,5	40	14,5	6	16	25	56	54	1+S/2	155	147

S = Stroke length, S in figure = 0 mm

- 1) Air actuated 5/2 and 5/3
- 2) Electrically actuated 5/2 with spring return
- 3) Electrically actuated 5/2 and 5/3 (2 solenoids)

Other dimensions according to P1C.

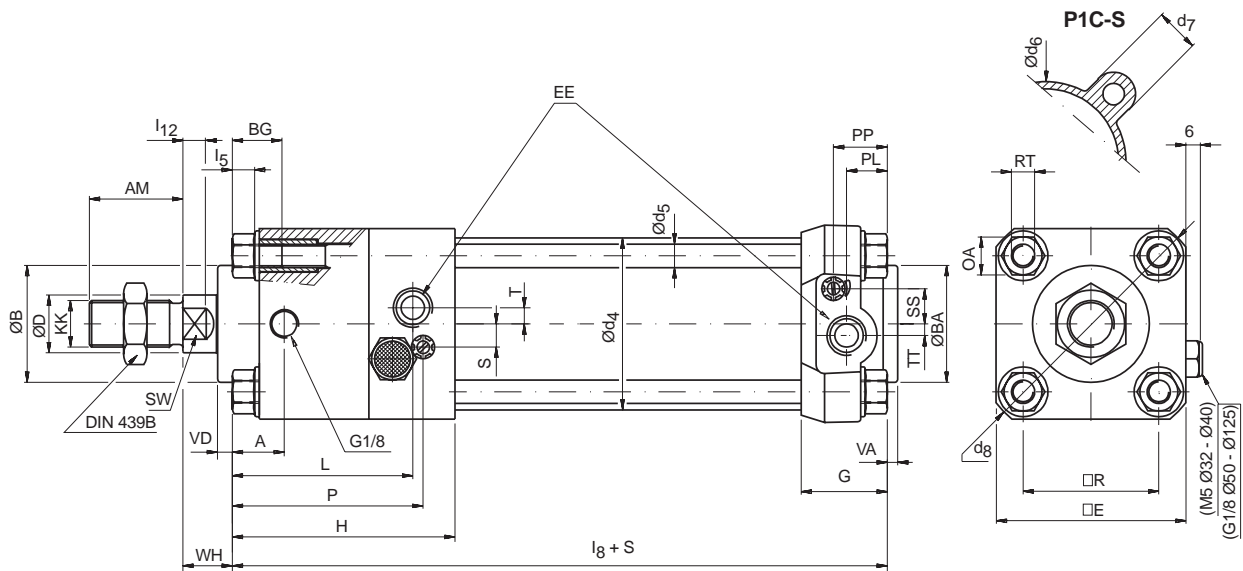

**Dimensions**

Cylinder bore mm	B mm	RT	d <sub>4</sub> mm	d <sub>5</sub> mm	d <sub>6</sub> mm	d <sub>7</sub> mm	d <sub>8</sub> mm	WH mm	R mm	BG mm	VD mm	VA mm	G mm	H mm
32	30	M6	36	5,3	36	11	62	15	32,5	16	4,5	3,5	26	69
40	35	M6	44	5,3	44	11	70	16	38	16	4,5	3,5	30	74
50	40	M8	55	7,1	55	15	84	17	46,5	16	5	3,5	29,5	76,5
63	45	M8	68	7,1	69	15	98	17	56,5	16	5	3,5	34,5	91,5
80	45	M10	86	8,9	86	17	124	20	72	16	4	3,5	35	106
100	55	M10	106	8,9	107	17	148	20	89	16	4	3,5	40	128
125	60	M12	132	10,75	133	20	184	27	110	20	6	5,5	44,5	138,5

Cylinder bore mm	l <sub>8</sub> mm	l <sub>5</sub> mm	E mm	PL mm	L mm	PP mm	P mm	A mm	l <sub>12</sub> mm	SW mm	BA	KK	AM mm
32	137	5,5	50	13	51	16	59	16	6	10	30	M10X1,25	22
40	149	5,5	55	14	53,5	19	63	16	6,5	13	35	M12X1,25	24
50	153	7,5	65	14	62	18,5	65	18	8	16	40	M16X1,5	32
63	178	7,5	75	16	72	20,5	82	26	8	16	45	M16X1,5	32
80	199	8	95	16,5	85	22	98	35	10	21	45	M20X1,5	40
100	226	8	110	19	107	27	117	50	10	21	55	M20X1,5	40
125	254	9	140	22	115,5	30	123,5	60	13	27	60	M27X2	54

Cylinder bore mm	EE mm	SS mm	S mm	TT mm	T mm	OA mm	D mm
32	G1/8	7	3	4,5	4,5	10	12
40	G1/4	10	7	5	3	10	16
50	G1/4	12	8	4	5,5	13	20
63	G3/8	11	8,5	7,5	3	13	20
80	G3/8	12	9	6	6	16	25
100	G1/2	14,5	12	6	6	16	25
125	G1/2	14,5	14	6	6	18	32

S=Stroke length

**Tolerances**

Cylinder bore mm	B	R mm	l <sub>8</sub> mm	BA	Stroke-length tolerance mm
32	e11	±0,5	±0,4	e11	+1/-0
40	e11	±0,5	±0,7	e11	+1/-0
50	e11	±0,6	±0,7	e11	+1/-0
63	e11	±0,7	±0,8	e11	+1/-0
80	e11	±0,7	±0,8	e11	+1/-0
100	e11	±0,7	±1	e11	+1/-0
125	e11	±1,1	±1	e11	+1/-0



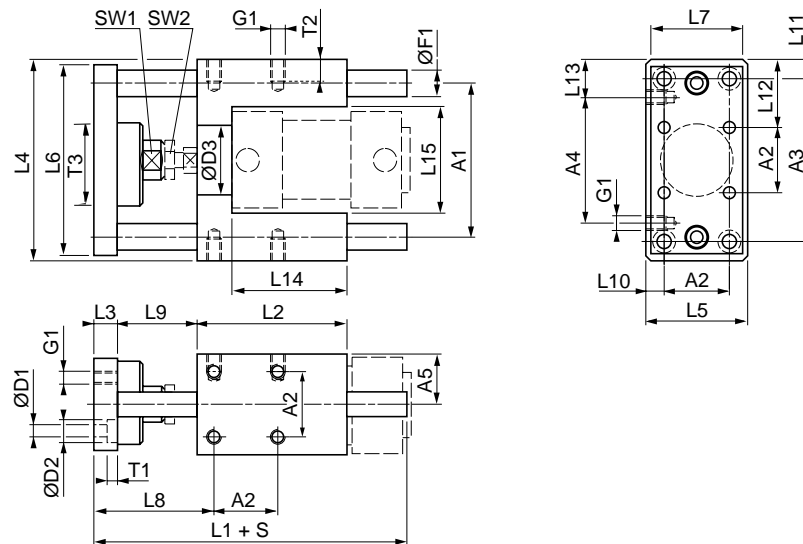

**Dimensions, U style guidance modules**

Cylinder bore mm	A <sub>1</sub> mm	A <sub>2</sub> mm	A <sub>3</sub> mm	A <sub>4</sub> mm	A <sub>5</sub> mm	D <sub>1</sub> mm	D <sub>2</sub> mm	D <sub>3</sub> mm	F <sub>1</sub> mm	G <sub>1</sub> mm	L <sub>1</sub> mm	L <sub>2</sub> mm	L <sub>3</sub> mm	L <sub>4</sub> mm	L <sub>5</sub> mm
32	74	32,5	78	61	25,0	6,6	11	30	12	M6	133	72	12	97	50
40	87	38,0	84	69	29,0	6,6	11	35	16	M6	149	84	12	115	58
50	104	46,5	100	85	35,0	9,0	15	40	20	M8	175	100	15	137	70
63	119	56,5	105	100	42,5	9,0	15	45	20	M8	190	115	15	152	85
80	148	72,0	130	130	52,0	11,0	18	45	25	M10	238	150	20	189	105
100	172	89,0	150	150	65,0	11,0	18	55	25	M10	249	165	20	213	130

Cylinder bore mm	L <sub>6</sub> mm	L <sub>7</sub> mm	L <sub>8</sub> mm	L <sub>9</sub> mm	L <sub>10</sub> mm	L <sub>11</sub> mm	L <sub>12</sub> mm	L <sub>13</sub> mm	L <sub>14</sub> mm	L <sub>15</sub> mm	SW <sub>1</sub> mm	SW <sub>2</sub> mm	T <sub>1</sub> mm	T <sub>2</sub> mm	T <sub>3</sub> mm
32	90	45	60,5 <sup>+2/0</sup>	35 <sup>+2/0</sup>	8,75	9,5	32,25	18,0	44	50,2	13	17	6,5	10	30 *
40	110	54	63,5 <sup>+2/0</sup>	41 <sup>+2/0</sup>	10,00	15,5	38,50	23,0	51	58,2	15	19	6,5	10	Ø45
50	130	63	76,0 <sup>+5/0</sup>	48 <sup>+4/0</sup>	11,75	18,5	45,25	26,0	60	70,2	22	24	9,0	13	Ø54
63	145	80	76,0 <sup>+5/0</sup>	48 <sup>+4/0</sup>	14,25	23,5	47,75	26,0	75	85,2	22	24	9,0	13	Ø54
80	180	100	93,0 <sup>+6/0</sup>	56 <sup>+6/0</sup>	16,50	29,5	58,50	29,5	116	105,4	27	30	11,0	16	Ø60
100	200	120	95,5 <sup>+6/0</sup>	56 <sup>+6/0</sup>	20,50	31,5	62,00	31,5	126	130,4	27	30	11,0	16	Ø60

\* For Allen key

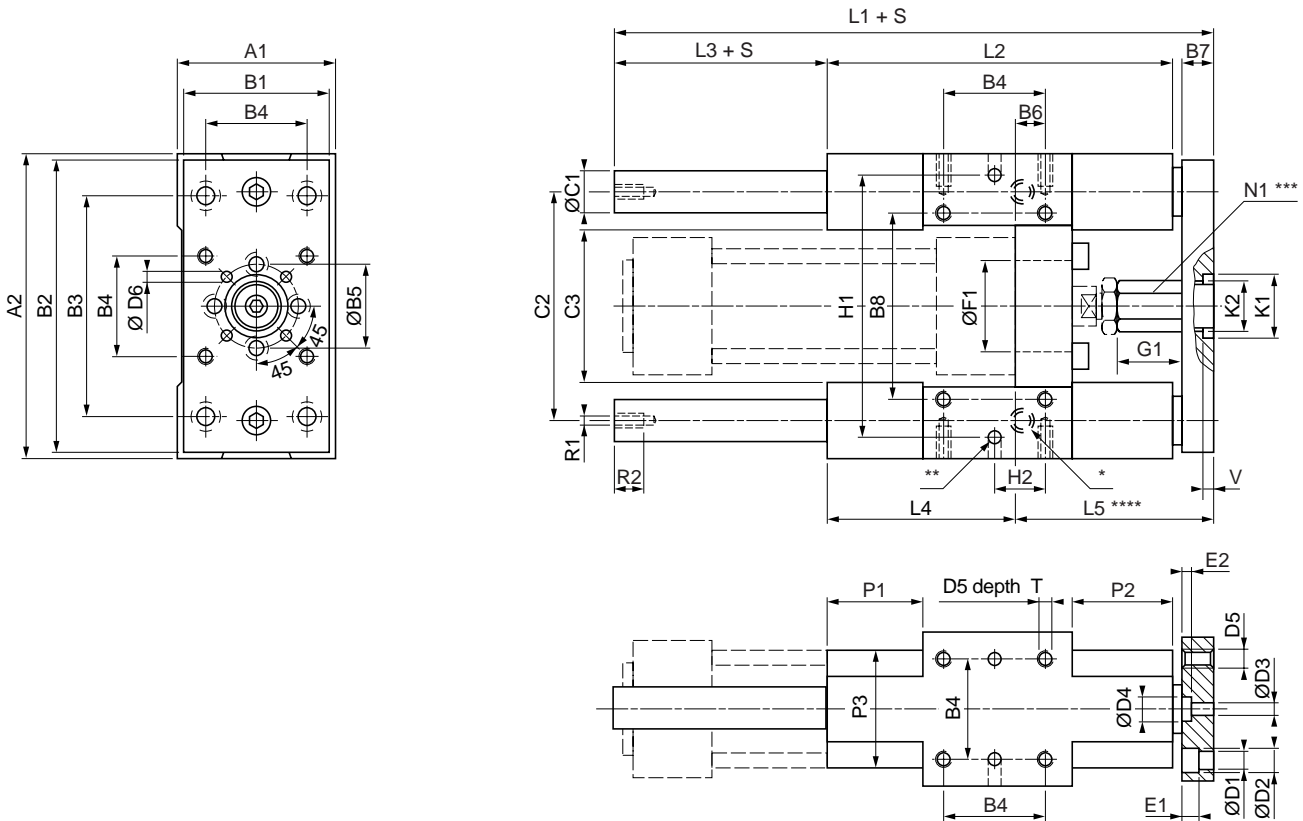

**Dimensions, H style guidance modules**

Cylinder bore mm	A <sub>1</sub> mm	A <sub>2</sub> mm	B <sub>1</sub> mm	B <sub>2</sub> mm	B <sub>3</sub> mm	B <sub>4</sub> mm	ØB <sub>5</sub> mm	B <sub>6</sub> mm	B <sub>7</sub> mm	B <sub>8</sub> mm	ØC <sub>1</sub> mm	C <sub>2</sub> mm	C <sub>3</sub> mm	ØD <sub>1</sub> mm	ØD <sub>2</sub> mm	ØD <sub>3</sub> mm
32	50	97	45	90	78	32,5	31,5	4,0	12	61	12	73,5	50	6,6	11	5,2
40	58	115	54	110	84	38,0	31,5	11,0	12	69	16	86,5	58	6,6	11	5,2
50	70	137	63	130	100	46,5	50,0	19,0	15	85	20	103,5	70	9,0	14	6,4
63	85	152	80	145	105	56,5	50,0	15,0	15	100	20	118,5	85	9,0	14	6,4
80	105	189	100	180	130	72,0	76,0	21,0	20	130	25	147,0	105	11,0	17	8,4
100	130	213	120	200	150	89,0	76,0	24,5	20	150	25	171,5	130	11,0	17	8,4

Cylinder bore mm	ØD <sub>4</sub> mm	D <sub>5</sub> mm	ØD <sub>6</sub> mm	E <sub>1</sub> mm	E <sub>2</sub> mm	ØF <sub>1</sub> <sup>+0,1/0</sup> mm	G <sub>1</sub> mm	L <sub>1</sub> mm	L <sub>2</sub> mm	L <sub>3</sub> mm	L <sub>4</sub> mm	L <sub>5</sub> mm	N <sub>1</sub> mm	P <sub>1</sub> <sup>±1</sup> mm	P <sub>2</sub> <sup>±1</sup> mm
32	9	M6	4	7	4	30	17	150	120	15	71	64	17	36	31
40	9	M6	4	7	4	35	24	170	130	25	71	74	17	36	36
50	11	M8	4	9	9	40	27	192	150	24	79	89	24	42	44
63	11	M8	4	9	9	45	27	222	180	24	109	89	24	58	44
80	14	M10	6	11	5	45	32	247	200	24	113	110	30	50	52
100	14	M10	6	11	5	55	32	267	220	24	128	115	30	49	51

Cylinder bore mm	P <sub>3</sub> mm	R <sub>1</sub> mm	R <sub>2</sub> mm	W mm	H <sub>1</sub> <sup>±0,05</sup> mm	H <sub>2</sub> mm	K <sub>1</sub> <sup>H8</sup> mm	K <sub>2</sub> mm	T mm	V <sup>+0,3/0</sup> mm
32	40	M6	11	5	81	16	24	19	12	4
40	44	M6	11	6	99	19	24	19	12	4
50	50	M8	16	8	119	23	38	26	16	4
63	60	M8	16	8	132	28	38	26	16	4
80	70	M10	16	10	166	36	46	32	20	4
100	70	M10	16	10	190	45	46	32	20	4

\* Lubricators  
 \*\* 6 hole Ø6 H7, depth 10<sup>+1/0</sup>  
 \*\*\* Hexagon profile  
 \*\*\*\* Min adjustment=0, max.=W

## Cylinder mountings

Type	Description	Cyl. bore Ø mm	Weight kg	Order code
<b>Flange MF1/MF2</b>	Intended for fixed mounting of cylinder. Flange can be fitted to front- or rear end-plates of cylinder.  Materials Flange: Surface-treated steel, black Mounting screws acc. to DIN 6912: Zinc-plated steel 8.8  Supplied complete with mounting screws for attachment to cylinder.	32	0,23	<b>P1C-4KMB</b>
		40	0,28	<b>P1C-4LMB</b>
		50	0,53	<b>P1C-4MMB</b>
		63	0,71	<b>P1C-4NMB</b>
		80	1,59	<b>P1C-4PMB</b>
		100	2,19	<b>P1C-4QMB</b>
125	3,78	<b>P1C-4RMB</b>		

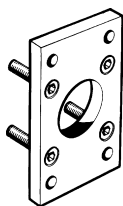

According to ISO MF1/MF2, VDMA 24 562 T.2/2-, AFNOR

Cyl. bore mm	d1 mm	FB mm	TG1 mm	E mm	R mm	MF mm	TF mm	UF mm	I1 mm	W mm	ZF mm	ZB mm
32	30	7	32,5	45	32	10	64	80	5	16	130	123,5
40	35	9	38	52	36	10	72	90	5	20	145	138,5
50	40	9	46,5	65	45	12	90	110	6,5	25	155	146,5
63	45	9	56,5	75	50	12	100	120	6,5	25	170	161,5
80	45	12	72	95	63	16	126	150	8	30	190	177,5
100	55	14	89	115	75	16	150	170	8	35	205	192,5
125	60	16	110	140	90	20	180	205	10,5	45	245	230,5

S = Stroke length

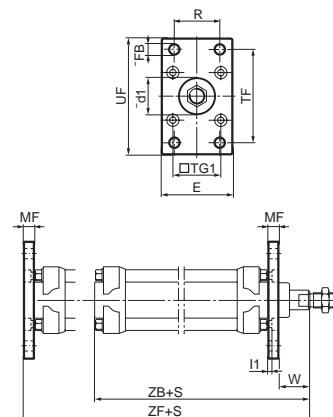

## Foot bracket MS1

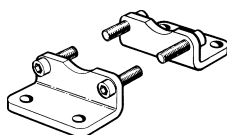

Intended for fixed mounting of cylinder. Foot bracket can be fitted to front- and rear end-covers of cylinder.

Materials  
Foot bracket: Surface-treated steel, black  
Mounting screws acc. to DIN 912: Zinc-plated steel 8.8

Supplied in pairs with mounting screws for attachment to cylinder.

32	0,06*	<b>P1C-4KMF</b>
40	0,08*	<b>P1C-4LMF</b>
50	0,16*	<b>P1C-4MMF</b>
63	0,25*	<b>P1C-4NMF</b>
80	0,50*	<b>P1C-4PMF</b>
100	0,85*	<b>P1C-4QMF</b>
125	1,48*	<b>P1C-4RMF</b>

\* Weight per item

According to ISO MS1, VDMA 24 562 T.2/7-, AFNOR

Cyl. bore mm	AB mm	TG1 mm	E mm	TR mm	AO mm	AU mm	AH mm	I7 mm	AT mm	I9 mm	SA mm
32	7	32,5	45	32	10	24	32	30	4,5	17	142
40	9	38	52	36	8	28	36	30	4,5	18,5	161
50	9	46,5	65	45	13	32	45	36	5,5	25	170
63	9	56,5	75	50	13	32	50	35	5,5	27,5	185
80	12	72	95	63	14	41	63	49	6,5	40,5	210
100	14	89	115	75	15	41	71	54	6,5	43,5	220
125	16	110	140	90	22	45	90	71	8	60	250

S = Stroke length

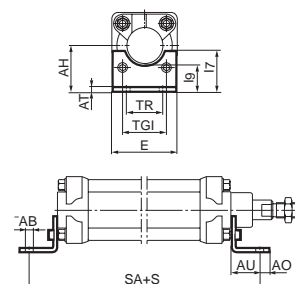

## Pivot bracket with rigid bearing

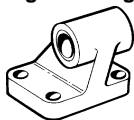

Intended for flexible mounting of cylinder. The pivot bracket can be combined with clevis bracket MP2.

Materials  
Pivot bracket: Surface-treated aluminium, black  
Bearing: Sintered oil-bronze bushing

32	0,06	<b>P1C-4KMD</b>
40	0,08	<b>P1C-4LMD</b>
50	0,15	<b>P1C-4MMD</b>
63	0,20	<b>P1C-4NMD</b>
80	0,33	<b>P1C-4PMD</b>
100	0,49	<b>P1C-4QMD</b>
125	1,02	<b>P1C-4RMD</b>

According to CETOP RP 107 P, VDMA 24 562 T.2/5-, AFNOR

Cyl. bore mm	CK mm	S5 mm	K1 mm	K2 mm	G1 mm	G2 mm	EM mm	G3 mm	CA mm	H6 mm	R1 mm
32	10	5,5	38	51	21	18	25,5	31	32	8	10
40	12	5,5	41	54	24	22	27	35	36	10	11
50	12	9	50	65	33	30	31	45	45	12	13
63	16	9	52	67	37	35	39	50	50	12	15
80	16	11	66	86	47	40	49	60	63	14	15
100	20	11	76	96	55	50	59	70	71	15	19
125	25	14	94	124	70	60	69	90	90	20	22,5

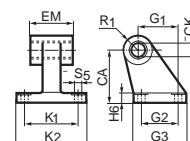

## Cylinder mountings

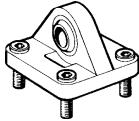
Type	Description	Cyl. bore Ø mm	Weight kg	Order code
<b>Swivel eye bracket</b> 	Intended for use together with clevis bracket GA	32	0,20	<b>P1C-4KMS</b>
		40	0,30	<b>P1C-4LMS</b>
		50	0,50	<b>P1C-4MMS</b>
		63	0,70	<b>P1C-4NMS</b>
		80	1,20	<b>P1C-4PMS</b>
		100	1,60	<b>P1C-4QMS</b>
		125	1,80	<b>P1C-4RMS</b>
	Material Bracket: Surface-treated steel, black Swivel bearing acc. to DIN 648K: Hardened steel			
	Supplied complete with mounting screws for attachment to cylinder.			

According to VDMA 24 562 T.2/13-, AFNOR

Cyl. bore mm	E	B1	B2	EN	R1	R2	FL	I2	L	CN	XD	Z
mm	mm	mm	mm	mm	mm	mm	mm	mm	mm	H7	mm	mm
32	45	10,5	-	14	16	-	22	5,5	12	10	142	4°
40	52	12	-	16	18	-	25	5,5	15	12	160	4°
50	65	15	51	21	21	19	27	6,5	15	16	170	4°
63	75	15	-	21	23	-	32	6,5	20	16	190	4°
80	95	18	-	25	29	-	36	10	20	20	210	4°
100	115	18	-	25	31	-	41	10	25	20	230	4°

S = Stroke length

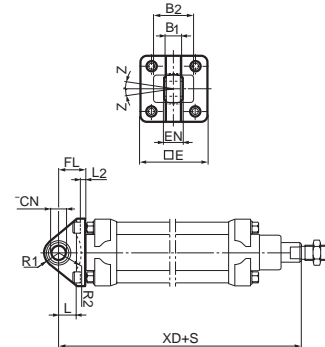

### Clevis bracket MP2

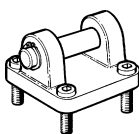

Intended for flexible mounting of cylinder. Clevis bracket MP2 can be combined with clevis bracket MP4.

Materials  
Clevis bracket: Surface-treated aluminium, black  
Pin: Surface hardened steel  
Circlips according to DIN 471: Spring steel  
Mounting screws acc. to DIN 912: Zinc-plated steel 8.8

Supplied complete with mounting screws for attachment to cylinder.

According to ISO MP2, VDMA 24 562 T.2/3-, AFNOR

Cyl. bore mm	C	E	UB	CB	FL	L	I2	CD	MR	XD
mm	mm	mm	h14	H14	±0,2	mm	mm	H9	mm	mm
32	53	45	45	26	22	13	5,5	10	10	142
40	60	52	52	28	25	16	5,5	12	12	160
50	68	65	60	32	27	16	6,5	12	12	170
63	78	75	70	40	32	21	6,5	16	16	190
80	98	95	90	50	36	22	10	16	16	210
100	118	115	110	60	41	27	10	20	20	230
125	139	140	130	70	50	30	10	25	25	275

S = Stroke length

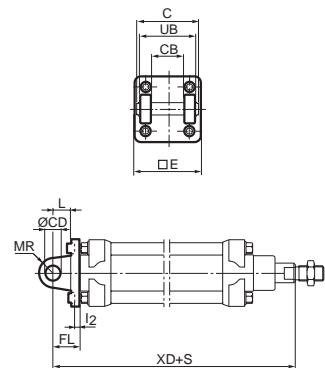

### Clevis bracket MP2 with stainless steel pin

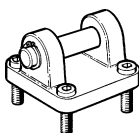

Intended for flexible mounting of cylinder. Clevis bracket MP2 can be combined with clevis bracket MP4.

Materials  
Clevis bracket: Surface-treated aluminium, black  
Pin: Stainless steel  
Circlips according to DIN 471: Stainless steel  
Mounting screws acc. to DIN 912: Stainless steel  
O-ring, NBR

Supplied complete with mounting screws for attachment to cylinder.

Dimensions acc. to MP2 above.

32	0,04	<b>9301054371</b>
40	0,10	<b>9301054372</b>
50	0,18	<b>9301054373</b>
63	0,25	<b>9301054374</b>
80	0,60	<b>9301054375</b>
100	0,70	<b>9301054376</b>
125	1,30	<b>9301054377</b>

## Cylinder mountings

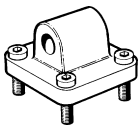
Type	Description	Cyl. bore Ø mm	Weight kg	Order code
<b>Clevis bracket MP4</b> 	Intended for flexible mounting of cylinder. Clevis bracket MP4 can be combined with clevis bracket MP2.  Materials Clevis bracket: Surface-treated aluminium, black Mounting screws acc. to DIN 912: Zinc-plated steel 8.8  Supplied complete with mounting screws for attachment to cylinder.	32	0,09	<b>P1C-4KME</b>
		40	0,13	<b>P1C-4LME</b>
		50	0,17	<b>P1C-4MME</b>
		63	0,36	<b>P1C-4NME</b>
		80	0,46	<b>P1C-4PME</b>
		100	0,83	<b>P1C-4QME</b>
125	1,53	<b>P1C-4RME</b>		

According to ISO MP4, VDMA 24 562 T.2/4-, AFNOR

Cyl. bore mm	E mm	EW mm	FL ±0,2 mm	L mm	I2 mm	CD H9 mm	MR mm	XD mm
32	45	26	22	13	5,5	10	10	142
40	52	28	25	16	5,5	12	12	160
50	65	32	27	16	6,5	12	12	170
63	75	40	32	21	6,5	16	16	190
80	95	50	36	22	10	16	16	210
100	115	60	41	27	10	20	20	230
125	140	70	50	30	10	25	25	275

S = Stroke length

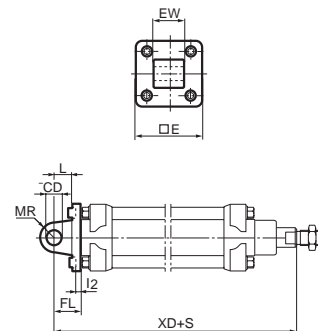

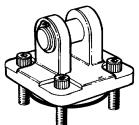
<b>Clevis bracket MP4 with sealing against cylinder</b> 	Intended for flexible mounting of cylinder. Clevis bracket MP4 can be combined with clevis bracket MP2.  Materials Clevis bracket: Surface-treated aluminium, black Pin: Stainless steel Circlips according to DIN 471: Stainless steel Mounting screws acc. to DIN 912: Stainless steel O-ring, NBR  Supplied complete with mounting screws for attachment to cylinder.	32	0,09	<b>9301054391</b>
		40	0,12	<b>9301054392</b>
		50	0,20	<b>9301054393</b>
		63	0,30	<b>9301054394</b>
		80	0,55	<b>9301054395</b>
		100	0,83	<b>9301054396</b>
125	1,54	<b>9301054397</b>		

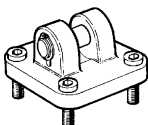
<b>Clevis bracket GA</b> 	Intended for flexible mounting of cylinder. Clevis bracket GA can be combined with pivot bracket with swivel bearing, swivel eye bracket and swivel rod eye.  Materials Clevis bracket: Surface-treated steel, black Pin: Surface hardened steel Locking pin: Spring steel Circlips according to DIN 471: Spring steel Mounting screws acc. to DIN 912: Zinc-plated steel 8.8  Supplied complete with mounting screws for attachment to cylinder.	32	0,22	<b>P1C-4KMC</b>
		40	0,29	<b>P1C-4LMC</b>
		50	0,48	<b>P1C-4MMC</b>
		63	0,68	<b>P1C-4NMC</b>
		80	1,39	<b>P1C-4PMC</b>
		100	2,04	<b>P1C-4QMC</b>
125	4,05	<b>P1C-4RMC</b>		

According to VDMA 24 562 T.2/10-, AFNOR

Cyl. bore mm	C mm	E mm	B2 d12 mm	B1 H14 mm	T mm	B3 mm	R2 mm	L1 mm	FL ±0,2 mm	I2 mm	L mm	CN F7 mm	R1 mm	XD mm
32	41	45	34	14	3	3,3	17	11,5	22	5,5	12	10	11	142
40	48	52	40	16	4	4,3	20	12	25	5,5	15	12	13	160
50	54	65	45	21	4	4,3	22	14	27	6,5	17	16	18	170
63	60	75	51	21	4	4,3	25	14	32	6,5	20	16	18	190
80	75	95	65	25	4	4,3	30	16	36	10	20	20	22	210
100	85	115	75	25	4	4,3	32	16	41	10	25	20	22	230
125	110	140	97	37	6	6,3	42	24	50	10	30	30	30	275

S = Stroke length

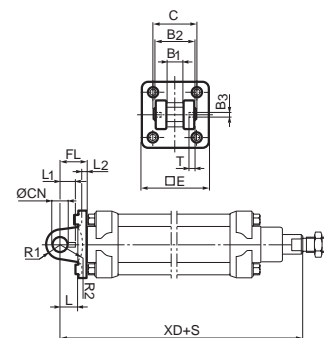

### Stainless steel Pin Set GA

Materials		
Pin: Stainless steel		
Locking pin: Stainless steel		
Circlips according to DIN 471: Stainless steel		
32	0,05	<b>9301054311</b>
40	0,06	<b>9301054312</b>
50	0,07	<b>9301054313</b>
63	0,07	<b>9301054314</b>
80	0,17	<b>9301054315</b>
100	0,31	<b>9301054316</b>
125	0,54	<b>9301054317</b>

For fitting screws in stainless steel see page 26.

## Cylinder mountings

Type	Description	Cyl. bore Ø mm	Weight kg	Order code
<b>Pivot bracket with swivel bearing</b> 	Intended for use together with clevis bracket GA.  Material Pivot bracket: Surface-treated steel, black Swivel bearing acc. to DIN 648K: Hardened steel	32	0,18	<b>P1C-4KMA</b>
		40	0,25	<b>P1C-4LMA</b>
		50	0,47	<b>P1C-4MMA</b>
		63	0,57	<b>P1C-4NMA</b>
		80	1,05	<b>P1C-4PMA</b>
		100	1,42	<b>P1C-4QMA</b>
		125	3,10	<b>P1C-4RMA</b>

According to VDMA 24 562 T.2/11-, AFNOR

Cyl. bore mm	CN H7 mm	S5 H13 mm	K1 JS14 mm	K2 mm	EU mm	G1 JS14 mm	G2 JS14 mm	EN mm	G3 mm	CH JS15 mm	H6 mm	ER mm	Z mm
32	10	6,6	38	51	10,5	21	18	14	31	32	10	16	4°
40	12	6,6	41	54	12,0	24	22	16	35	36	10	18	4°
50	16	9,0	50	65	15,0	33	30	21	45	45	12	21	4°
63	16	9,0	52	67	15,0	37	35	21	50	50	12	23	4°
80	20	11,0	66	86	18,0	47	40	25	60	63	14	28	4°
100	20	11,0	76	96	18,0	55	50	25	70	71	15	30	4°
125	30	14,0	94	124	25,0	70	60	37	90	90	20	40	4°

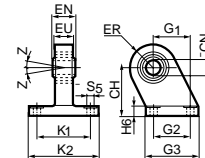

## Mounting kit

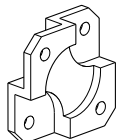

Mounting kit for back to back mounted cylinders, 3 and 4 position cylinders.

Material:  
Mounting, Aluminium  
Mounting screws, Zinc-plated steel 8.8

32	0,060	<b>P1E-6KB0</b>
40	0,078	<b>P1E-6LB0</b>
50	0,162	<b>P1E-6MB0</b>
63	0,194	<b>P1E-6NB0</b>
80	0,450	<b>P1E-6PB0</b>
100	0,672	<b>P1E-6QB0</b>

Cyl. bore mm	E mm	TG mm	ØFB mm	MF mm	A mm	ØBA mm
32	50	32,5	6,5	5	16	30
40	60	38,0	6,5	5	16	35
50	66	46,5	8,5	6	20	40
63	80	56,5	8,5	6	20	45
80	100	72,0	10,5	8	25	45
100	118	89,0	10,5	8	25	55

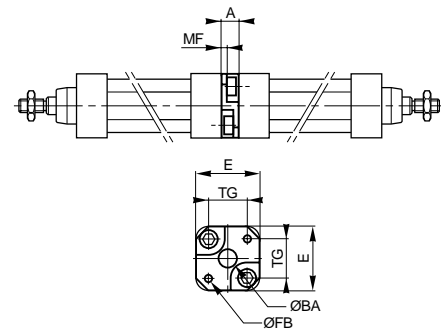

## Pivot bracket for MT4

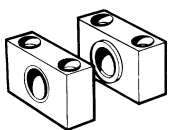

Intended for use together with central trunnion MT4.

Material  
Pivot bracket: Surface-treated aluminium  
Bearing acc. to DIN 1850 C: Sintered oil-bronze bushing

Supplied in pairs.

32	0,04*	<b>9301054261</b>
40	0,07*	<b>9301054262</b>
50	0,07*	<b>9301054262</b>
63	0,12*	<b>9301054264</b>
80	0,12*	<b>9301054264</b>
100	0,21*	<b>9301054266</b>
125	0,21*	<b>9301054266</b>

\* Weight per item

According to ISO, VDMA 24 562 T.2/9-, AFNOR

Cyl. bore mm	B1 mm	B2 mm	A mm	C mm	d1 mm	d2 H13 mm	H1 mm	H2 mm	fx45° min
32	46	18,0	32	10,5	12	6,6	30	15	1,0
40	55	21,0	36	12,0	16	9,0	36	18	1,6
50	55	21,0	36	12,0	16	9,0	36	18	1,6
63	65	23,0	42	13,0	20	11,0	40	20	1,6
80	65	23,0	42	13,0	20	11,0	40	20	1,6
100	75	28,5	50	16,0	25	14,0	50	25	2,0
125	75	28,5	50	16,0	25	14,0	50	25	2,0

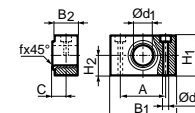

## Cylinder mountings

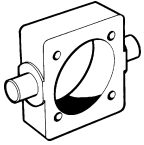
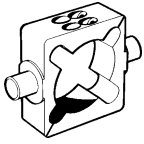
Type	Description	Cyl. bore Ø mm	Weight kg	Order code
<b>Centre trunnion MT4 for P1C-T</b> 	Intended for flexible mounting of cylinder. Centre trunnion is factory-fitted to cylinder tie-rods at specified XV measure. Combined with pivot bracket for MT4. Centre trunnion for the P1C-T series is mounted with special threaded tie rods. When ordering a cylinder with factory-fitted centre trunnion, see order key on pages 8 and 12.	32	0,20	<b>See order key on pages 8 and 12.</b>
		40	0,30	
		50	0,40	
		63	0,80	
		80	1,06	
		100	1,98	
		125	2,80	
<b>Centre trunnion MT4 for P1C-S</b> 	On the P1C-S series the central trunnion is mounted on the profile barrel.  When ordering a cylinder with factory-fitted centre trunnion, see order key on pages 8 and 12.  Material: Ø32-100 Al-bronze CuAl10Fe3 Ø125 Zinc-plated cast iron	32	0,20	<b>P1C-4KMY</b> <b>P1C-4LMY</b> <b>P1C-4MMY</b> <b>P1C-4NMY</b> <b>P1C-4PMY</b> <b>P1C-4QMY</b> <b>P1C-4RMY</b>
		40	0,30	
		50	0,40	
		63	0,80	
		80	1,06	
		100	1,98	
		125	2,80	

According to ISO MT4, VDMA 24 562 T.2/8-, AFNOR

Cyl. bore mm	TM h14 mm	TL h14 mm	TD e9 mm	R mm	UW P1C-T mm	UW P1C-S mm	I1 P1C-T mm	I1 P1C-S mm
32	50	12	12	0,4	48	65	15	25
40	63	16	16	0,4	60	75	20	25
50	75	16	16	0,4	68	95	23	30
63	90	20	20	0,6	82	105	35	35
80	110	20	20	0,6	99	130	35	40
100	132	25	25	0,6	121	145	45	45
125	160	25	25	0,8	148	160	48	55

Cyl. bore mm	X1 mm	XV <sub>min</sub> P1C-T mm	XV <sub>min</sub> P1C-S mm	X2 P1C-T mm	X2 P1C-S mm
32	73	60	96	86	50
40	82,5	70	100	95	95
50	90	78	120	102	60
63	97,5	89	125	106	70
80	110	99	150	121	70
100	120	114	158	126	82
125	145	134	191	156	99

$XV_{std} = X1 + \text{Stroke length}/2$   
 $XV_{max} = X2 + \text{Stroke length}$

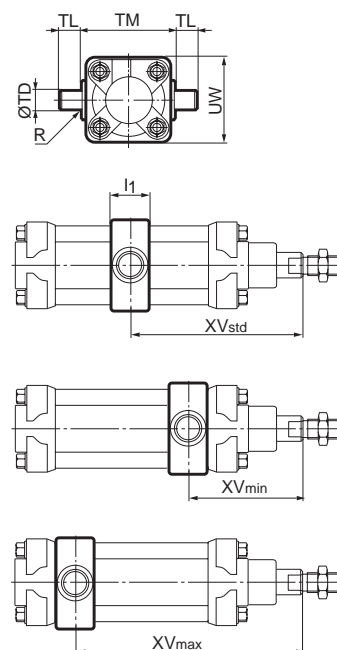

## Piston rod mountings

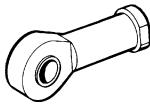
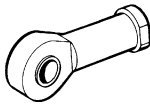
Type	Description	Cyl. bore Ø mm	Weight kg	Order code
<b>Swivel rod eye</b> 	Swivel rod eye for articulated mounting of cylinder. Swivel rod eye can be combined with clevis bracket GA. Maintenance-free.  Materials Swivel rod eye, nut: Zinc-plated steel Swivel bearing according to DIN 648K: Hardened steel	32	0,08	<b>P1C-4KRS</b>
		40	0,12	<b>P1C-4LRS</b>
		50	0,25	<b>P1C-4MRS</b>
		63	0,25	<b>P1C-4MRS</b>
		80	0,46	<b>P1C-4PRS</b>
		100	0,46	<b>P1C-4PRS</b>
125	1,28	<b>P1C-4RRS</b>		
<b>Stainless steel swivel rod eye</b> 	Stainless-steel swivel rod eye for articulated mounting of cylinder. Swivel rod eye can be combined with clevis bracket GA. Maintenance-free.  Materials Swivel rod eye, nut: Stainless steel Swivel bearing according to DIN 648K: Stainless steel	32	0,08	<b>P1S-4JRT</b>
		40	0,12	<b>P1S-4LRT</b>
		50	0,25	<b>P1S-4MRT</b>
		63	0,25	<b>P1S-4MRT</b>
		80	0,46	<b>P1S-4PRT</b>
		100	0,46	<b>P1S-4PRT</b>
125	1,28	<b>P1S-4RRT</b>		

According to ISO 8139

Cyl. bore mm	A mm	B min mm	B max mm	CE mm	CN H9 mm	EN h12 mm	ER mm	KK	LE min mm	N mm	O mm	Z mm
32	20	48	55	43	10	14	14	M10x1,25	15	17	10,5	12°
40	22	56	62	50	12	16	16	M12x1,25	17	19	12	12°
50	28	72	80	64	16	21	21	M16x1,5	22	22	15	15°
63	28	72	80	64	16	21	21	M16x1,5	22	22	15	15°
80	33	87	97	77	20	25	25	M20x1,5	26	32	18	15°
100	33	87	97	77	20	25	25	M20x1,5	26	32	18	15°
125	51	123,5	137	110	30	37	35	M27x2	36	41	25	15°

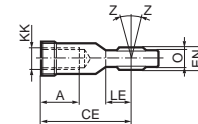
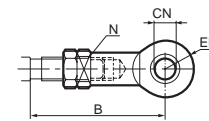

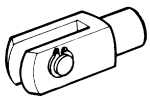
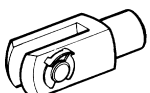
<b>Clevis</b> 	Clevis for articulated mounting of cylinder.  Material Clevis, clip, nut: Galvanized steel Pin: Hardened steel	32	0,09	<b>P1C-4KRC</b>
		40	0,15	<b>P1C-4LRC</b>
		50	0,35	<b>P1C-4MRC</b>
		63	0,35	<b>P1C-4MRC</b>
		80	0,75	<b>P1C-4PRC</b>
		100	0,75	<b>P1C-4PRC</b>
125	2,10	<b>P1C-4RRC</b>		
<b>Stainless steel clevis</b> 	Stainless-steel clevis for articulated mounting of cylinder.  Material Clevis, nut: Stainless steel Pin: Stainless steel Circlips according to DIN 471: Stainless steel	32	0,09	<b>P1S-4JRD</b>
		40	0,15	<b>P1S-4LRD</b>
		50	0,35	<b>P1S-4MRD</b>
		63	0,35	<b>P1S-4MRD</b>
		80	0,75	<b>P1S-4PRD</b>
		100	0,75	<b>P1S-4PRD</b>
125	2,10	<b>P1S-4RRD</b>		

According to ISO 8140

Cyl. bore mm	A mm	B min mm	B max mm	CE mm	CK h11/E9 mm	CL mm	CM mm	ER mm	KK	LE mm	O mm
32	20	45	52	40	10	20	10	16	M10x1,25	20	28
40	24	54	60	48	12	24	12	19	M12x1,25	24	32
50	32	72	80	64	16	32	16	25	M16x1,5	32	41,5
63	32	72	80	64	16	32	16	25	M16x1,5	32	41,5
80	40	90	100	80	20	40	20	32	M20x1,5	40	50
100	40	90	100	80	20	40	20	32	M20x1,5	40	50
125	56	123,5	137	110	30	55	30	45	M27x2	54	72

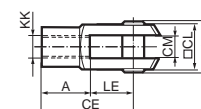
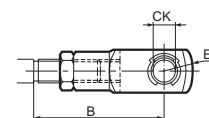



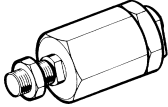

## Accessories

Type	Description	Cyl. bore Ø mm	Weight kg	Order code
<b>Flexo coupling</b> 	Flexo coupling for articulated mounting of piston rod. Flexo coupling is intended to take up axial angle errors within a range of ±4°. Material Flexocoupling, nut: Zinc-plated steel Socket: Hardened steel	32	0,21	<b>P1C-4KRF</b>
		40	0,22	<b>P1C-4LRF</b>
		50	0,67	<b>P1C-4MRF</b>
		63	0,67	<b>P1C-4MRF</b>
		80	0,72	<b>P1C-4PRF</b>
		100	0,72	<b>P1C-4PRF</b>
		125	1,80	<b>P1C-4RRF</b>

Supplied complete with galvanized adjustment nut.

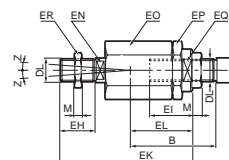
Cyl. bore mm	B min mm	B max mm	DL	EH	EI	EK	EL	EN	EO	EP	EQ	ER	M	Z
mm	mm	mm		mm	mm	mm	mm	mm	mm	mm	mm	mm	mm	mm
32	36	43	M10x1,25	20	23	70	31	12	30	30	19	30	5	4°
40	37	43	M12x1,25	23	23	67	31	12	30	30	19	30	6	4°
50	53	61	M16x1,5	40	32	112	45	19	41	41	30	41	8	4°
63	53	61	M16x1,5	40	32	112	45	19	41	41	30	41	8	4°
80	57	67	M20x1,5	39	42	122	56	19	41	41	30	41	10	4°
100	57	67	M20x1,5	39	42	122	56	19	41	41	30	41	10	4°
125	75,5	89	M27x2	48	48	145	60	24	55	55	32	55	13,5	4°



<b>Nut</b> 	Intended for fixed mounting of accessories to the piston rod.	32	0,007	<b>9128985601</b>
		40	0,010	<b>0261109910</b>
	Material:	50	0,021	<b>9128985603</b>
	Galvanized steel	63	0,021	<b>9128985603</b>
		80	0,040	<b>0261109911</b>
	(Cylinders supplied with galvanized nut)	100	0,040	<b>0261109911</b>
		125	0,100	<b>0261109912</b>

<b>Stainless steel nut</b> 	Intended for fixed mounting of accessories to the piston rod.	32	0,007	<b>9126725404</b>
		40	0,010	<b>9126725405</b>
	Material:	50	0,021	<b>9126725406</b>
	Stainless steel	63	0,021	<b>9126725406</b>
		80	0,040	<b>0261109921</b>
	(Cylinders supplied with galvanized nut)	100	0,040	<b>0261109921</b>
		125	0,100	<b>0261109922</b>



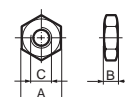

<b>Acid-proof nut</b> 	Intended for fixed mounting of accessories to the piston rod.	32	0,007	<b>0261109919</b>
		40	0,010	<b>0261109920</b>
	Material:	50	0,021	<b>0261109917</b>
	Acid-proof steel	63	0,021	<b>0261109917</b>
		80	0,040	<b>0261109916</b>
	(Cylinders with acid-proof piston rod are supplied with nut of acid-proof steel)	100	0,040	<b>0261109916</b>
		125	0,100	<b>0261109918</b>

According to DIN 439 B

Cyl. bore mm	A mm	B mm	C
32	17	5	M10x1,25
40	19	6	M12x1,25
50	24	8	M16x1,5
63	24	8	M16x1,5
80	30	10	M20x1,5
100	30	10	M20x1,5
125	41	13,5	M27x2

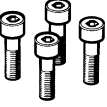

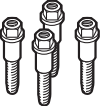
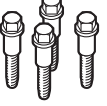
**Accessories**

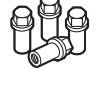
Type	Description	Cyl. bore Ø mm	Weight kg	Order code
<b>Screw set for MP2, MP4, MS1 and GA</b> 	Set of screws for fitting clevis brackets MP2, MP4 and GA. The screws have an internal hexagonal head and are used in special environments, e.g. the food industry, or where there are extra demands for protection against corrosion.  Material: According to DIN 912, Stainless steel, A2	32	0,02	<b>9301054321</b>
		40	0,02	<b>9301054321</b>
		50	0,05	<b>9301054322</b>
		63	0,05	<b>9301054322</b>
		80	0,09	<b>9301054323</b>
		100	0,09	<b>9301054323</b>
		125	0,15	<b>9301054324</b>
4 pcs per pack.				
<b>Screw set for MF1/MF2</b> 	Set of screws for fitting flanges MF1/MF2. The screws have an internal hexagonal head and are used in special environments, e.g. the food industry, or where there are extra demands for protection against corrosion.  Material: According to DIN 6912, Stainless steel, A2	32	0,02	<b>9301054331</b>
		40	0,02	<b>9301054331</b>
		50	0,04	<b>9301054332</b>
		63	0,04	<b>9301054332</b>
		80	0,07	<b>9301054333</b>
		100	0,07	<b>9301054333</b>
		125	0,12	<b>9301054334</b>
4 pcs per pack.				
<b>End cover screw set for P1C-S</b> 	Set of screws with internal thread. The screws have an external hexagonal head and are used in special environments, e.g. the food industry, or where there are extra demands for protection against corrosion.  Material: Screw, stainless steel, A2	32	0,01	<b>9121715980</b>
		40	0,01	<b>9121715980</b>
		50	0,02	<b>9121715981</b>
		63	0,02	<b>9121715981</b>
		80	0,02	<b>9121715982</b>
		100	0,02	<b>9121715982</b>
		125	0,03	<b>9121715983</b>
4 pcs per pack.				
<b>End cover screw set for P1C-S</b> 	Set of screws without internal thread. The screws have an external hexagonal head and are used in special environments, e.g. the food industry, or where there are extra demands for protection against corrosion.  Material: Screw, stainless steel, A2	32	0,01	<b>9121715984</b>
		40	0,01	<b>9121715984</b>
		50	0,02	<b>9121715985</b>
		63	0,02	<b>9121715985</b>
		80	0,02	<b>9121715986</b>
		100	0,02	<b>9121715986</b>
		125	0,03	<b>9121715987</b>
4 pcs per pack.				
<b>End cover nut set for P1C-L with rod locking</b> 	Set of nuts with internal thread. The nuts have an external hexagonal head and are used in special environments, e.g. the food industry, or where there are extra demands for protection against corrosion.  Material: Nut, stainless steel, A2	32	0,01	<b>9121715970</b>
		40	0,01	<b>9121715970</b>
		50	0,01	<b>9121715971</b>
		63	0,01	<b>9121715971</b>
		80	0,02	<b>9121715972</b>
		100	0,02	<b>9121715972</b>
		125	0,03	<b>9121715973</b>
4 pcs per pack.				
<b>End cover nut set for P1C-L with rod locking</b> 	Set of nuts without internal thread. The nuts have an external hexagonal head and are used in special environments, e.g. the food industry, or where there are extra demands for protection against corrosion.  Material: Nut, stainless steel, A2	32	0,01	<b>9121715974</b>
		40	0,01	<b>9121715974</b>
		50	0,01	<b>9121715975</b>
		63	0,01	<b>9121715975</b>
		80	0,02	<b>9121715976</b>
		100	0,02	<b>9121715976</b>
		125	0,03	<b>9121715977</b>
4 pcs per pack.				

## Combinations

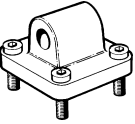
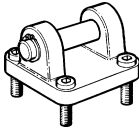
Type	Description	Cyl. bore Ø mm	Weight kg	Order code	
<b>Clevis bracket MP4</b> 	<b>Clevis bracket MP2</b> 	In this combination the clevis bracket MP4 is attached to the indicated cylinder.	32	0,17	<b>P1C-4KML</b>
		40	0,24	<b>P1C-4LML</b>	
		50	0,31	<b>P1C-4MML</b>	
		63	0,65	<b>P1C-4NML</b>	
		80	0,82	<b>P1C-4PML</b>	
		100	1,47	<b>P1C-4QML</b>	
125	2,70	<b>P1C-4RML</b>			
<b>Clevis bracket MP4</b> 	<b>Clevis bracket MP2</b> 	Same as above but with screws and pin in stainless steel.	32	0,13	<b>P1C-4KMG</b>
		40	0,23	<b>P1C-4LMG</b>	
		50	0,35	<b>P1C-4MMG</b>	
		63	0,61	<b>P1C-4NMG</b>	
		80	0,66	<b>P1C-4PMG</b>	
		100	1,53	<b>P1C-4QMG</b>	
125	2,83	<b>P1C-4RMG</b>			

Cyl. bore mm	A	B	C	CD	d3	E	FL	L	TG1	XA	XD	Z
mm	mm	mm	mm	mm	H9 H13	mm	±0,2	mm	mm	mm	mm	mm
32	9	44	53	10	6,6	45	22	13	32,5	164	142	112°
40	9	50	60	12	6,6	52	25	16	38	185	160	122°
50	11	54	68	12	9	65	27	16	46,5	197	170	94°
63	11	64	78	16	9	75	32	21	56,5	222	190	112°
80	14	72	98	16	11	95	36	22	72	246	210	82°
100	14	82	118	20	11	115	41	27	89	271	230	90°
125	20	100	139	25	13,5	140	50	30	110	325	275	94°

S = Stroke length

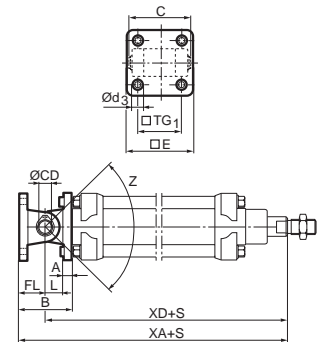

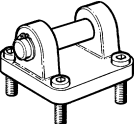
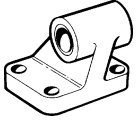
<b>Clevis bracket MP2</b> 	<b>Pivot bracket with rigid bearing</b> 	In this combination the clevis bracket MP2 is attached to the indicated cylinder.	32	0,14	<b>P1C-4KMP</b>
		40	0,19	<b>P1C-4LMP</b>	
		50	0,29	<b>P1C-4MMP</b>	
		63	0,49	<b>P1C-4NMP</b>	
		80	0,69	<b>P1C-4PMP</b>	
		100	1,13	<b>P1C-4QMP</b>	
125	2,83	<b>P1C-4RMP</b>			
<b>Clevis bracket MP2</b> 	<b>Pivot bracket with rigid bearing</b> 	Same as above but with screws and pin in stainless steel.	32	0,10	<b>P1C-4KMK</b>
		40	0,18	<b>P1C-4LMK</b>	
		50	0,33	<b>P1C-4MMK</b>	
		63	0,45	<b>P1C-4NMK</b>	
		80	0,93	<b>P1C-4PMK</b>	
		100	1,19	<b>P1C-4QMK</b>	
125	2,32	<b>P1C-4RMK</b>			

Cyl. bore mm	A	CA	D	E	G1	G2	G3	H6	k1	k2	S5	XA	XD	Z1	Z2
mm	mm	JS15	mm	mm	JS14	JS14	mm	mm	JS14	mm	H13	mm	mm	mm	mm
32	43	32	53	45	21	18	31	8	38	51	6,6	169,5	142	114°	68°
40	49	36	60	52	24	22	35	10	41	54	6,6	190,5	160	112°	68°
50	60	45	68	65	33	30	45	12	50	65	9	210,5	170	119°	62°
63	69	50	78	75	37	35	50	12	52	67	9	234,5	190	113°	68°
80	83	63	98	95	47	40	60	14	66	86	11	267	210	111°	61°
100	96	71	118	115	55	50	70	15	76	96	11	295	230	111°	64°
125	120	90	139	140	70	60	90	20	94	124	14	360	275	111°	60°

S = Stroke length

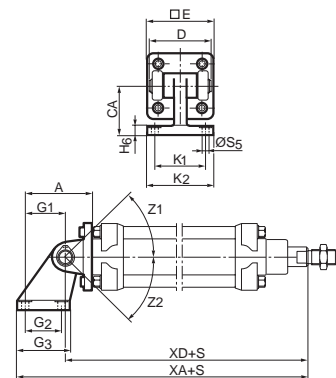

## Combinations

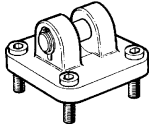
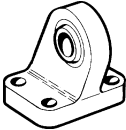
Type	Description	Cyl. bore Ø mm	Weight kg	Order code	
<b>Clevis bracket GA</b> 	<b>Pivot bracket with swivel bearing</b> 	In this combination the clevis bracket GA is attached to the indicated cylinder.	32	0,40	<b>P1C-4KMQ</b>
		40	0,54	<b>P1C-4LMQ</b>	
		50	0,95	<b>P1C-4MMQ</b>	
		63	1,25	<b>P1C-4NMQ</b>	
		80	2,44	<b>P1C-4PMQ</b>	
		100	3,46	<b>P1C-4QMQ</b>	
		125	7,15	<b>P1C-4RMQ</b>	

Cyl. bore mm	CH mm	E mm	ER mm	G1 JS14 mm	G2 JS14 mm	G3 mm	H6 mm	k1 JS14 mm	k2 mm	l3 mm	S5 H13 mm	XD mm	Z1 °	Z2 °	Z3 °
32	32	45	16	21	18	31	10	38	51	41	6,6	142	4°	105°	47°
40	36	52	18	24	22	35	10	41	54	48	6,6	160	4°	112°	56°
50	45	65	21	33	30	45	12	50	65	54	9	170	4°	107°	56°
63	50	75	23	37	35	50	12	52	67	60	9	190	4°	113°	57°
80	63	95	28	47	40	60	14	66	86	75	11	210	4°	105°	42°
100	71	115	30	55	50	70	15	76	96	85	11	230	4°	104°	53°
125	90	140	40	70	60	90	20	94	124	110	14	275	4°	99°	54°

S = Stroke length

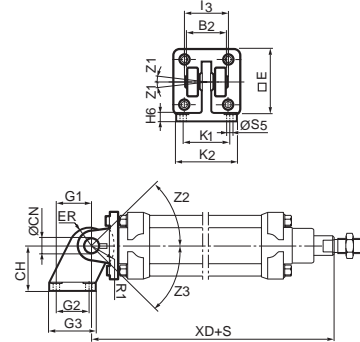

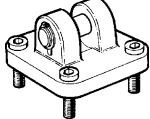
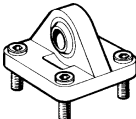
Type	Description	Cyl. bore Ø mm	Weight kg	Order code	
<b>Clevis bracket GA</b> 	<b>Swivel eye bracket</b> 	In this combination the clevis bracket GA or the Swivel eye bracket can be attached to the indicated cylinder.	32	0,42	<b>P1C-4KMM</b>
		40	0,59	<b>P1C-4LMM</b>	
		50	0,98	<b>P1C-4MMM</b>	
		63	1,38	<b>P1C-4NMM</b>	
		80	2,59	<b>P1C-4PMM</b>	
		100	3,64	<b>P1C-4QMM</b>	
		125	5,85	<b>P1C-4RMM</b>	

Cyl. bore mm	A mm	B mm	C mm	CN h9 mm	d3 H13 mm	E mm	FL ±0,2 mm	L mm	TG1 mm	XA mm	XD mm	Z1 °	Z2 °
32	10	44	41	10	6,6	45	22	12	32,5	164	142	4°	105°
40	10	50	48	12	6,6	52	25	15	38	185	160	4°	122°
50	10	54	54	16	9	65	27	17	46,5	197	170	4°	84°
63	12	64	60	16	9	75	32	20	56,5	222	190	4°	116°
80	16	72	75	20	11	95	36	20	72	246	210	4°	84°
100	16	82	85	20	11	115	41	25	89	271	230	4°	90°

S = Stroke length

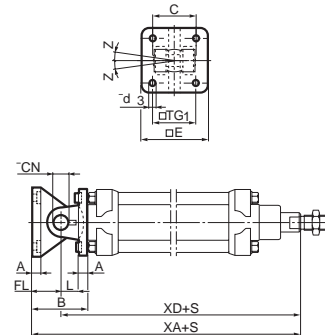

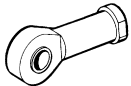
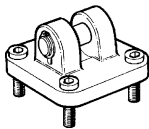
Type	Description	Cyl. bore Ø mm	Weight kg	Order code	
<b>Swivel rod eye</b> 	<b>Clevis bracket GA</b> 	In this combination the swivel rod eye is attached to the indicated cylinder.	32	0,30	<b>P1C-4KRV</b>
		40	0,41	<b>P1C-4LRV</b>	
		50	0,73	<b>P1C-4MRV</b>	
		63	0,93	<b>P1C-4NRV</b>	
		80	1,85	<b>P1C-4PRV</b>	
		100	2,50	<b>P1C-4QRV</b>	
		125	5,33	<b>P1C-4RRV</b>	

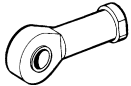
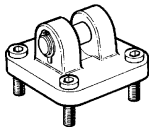
Type	Description	Cyl. bore Ø mm	Weight kg	Order code	
<b>Swivel rod eye</b> 	<b>Clevis bracket GA rigid bearing</b> 	Same as above but with screws and pin in stainless steel.	32	0,30	<b>P1C-4KRW</b>
		40	0,41	<b>P1C-4LRW</b>	
		50	0,73	<b>P1C-4MRW</b>	
		63	0,93	<b>P1C-4NRW</b>	
		80	1,85	<b>P1C-4PRW</b>	
		100	2,50	<b>P1C-4QRW</b>	
		125	5,33	<b>P1C-4RRW</b>	

Cyl. bore mm	A mm	B <sub>min</sub> mm	B <sub>max</sub> mm	CE mm	E mm	ER mm	FL mm	k mm	kk mm	M mm	l mm	TG1 mm	Z1 °	Z2 °
32	20	48	55	43	45	14	22	17	M10x1,25	5	41	32,5	4°	208°
40	22	56	62	50	52	16	25	19	M12x1,25	6	48	38	4°	214°
50	28	72	80	64	65	21	27	22	M16x1,5	8	54	46,5	4°	206°
63	28	72	80	64	75	21	32	22	M16x1,5	8	60	56,5	4°	214°
80	33	87	97	77	95	25	36	32	M20x1,5	10	75	72	4°	198°
100	33	87	97	77	115	25	41	32	M20x1,5	10	85	89	4°	208°
125	51	123,5	137	110	140	35	50	41	M27x2	13,5	110	110	4°	200°

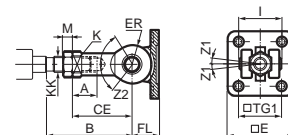

## Combinations

Type and description

### Cylinder with factory fitted mountings

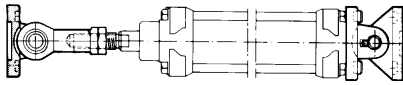

The cylinders can be ordered complete with factory fitted mountings. See order key on page 12 or contact our sales department.

### 3 and 4 position cylinders

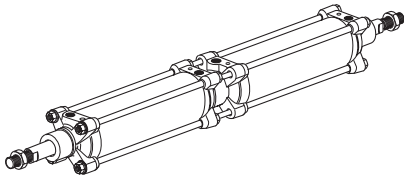

3 and 4 position cylinders series P1C-T is manufactured to a complete unit at the factory, contact customer service.

3 and 4 position cylinders series P1C-S bores up to 100 mm can be mounted together with a mounting kit. See page 22.

#### 3 position cylinders

3 position cylinders consist of two cylinders with equal stroke lengths.

#### 4 position cylinders

4 position cylinders consist of two cylinders with unequal stroke lengths.

Cylinder bore mm	A, P1C-T mm	A, P1C-S mm
32	247	256
40	277	286
50	293	306
63	323	336
80	355	373
100	385	403
125	461	-

S = Stroke length

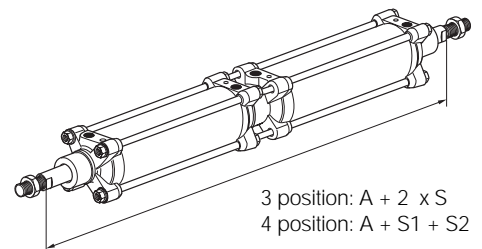

3 position:  $A + 2 \times S$   
4 position:  $A + S1 + S2$

**Reed switch sensors**

The reed switch sensors incorporate a well-proven, universal-voltage. This together with LED indication, two-wire connections and compact dimensions make them suitable for a wide range of applications. They can operate with PLC control systems as well as with conventional valves.

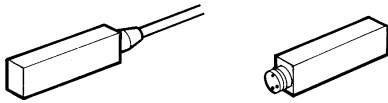

**Technical data**

Design	Reed
Output	Making
Voltage range	10-250 VAC/VDC
Voltage range, 9126344301 and 9126344302	
Voltage range, 9126344309	10-60 VAC/75 VDC
Voltage drop	max. 2,2 V
Load current	max. 0,5 A
	min. 2 mA
Breaking power (resistive)	max. 30/20 VA/W
Actuating distance	min. 9 mm
Hysteresis	1 mm
Repeatability accuracy	±0,01 mm
On/off switching frequency	max. 500 Hz
On switching time	max. 0,6 ms
Off switching time	max. 0,05 ms
Encapsulation	IP 67 (DIN 40 050)
Temperature range	-25 °C to +80 °C
Indication	LED, yellow
Material housing	PEI
Material mould	Epoxy
Weight sensor incl. 3 m cable	68 g
Cable	PVC 2x0.25 mm <sup>2</sup>
Weight cable excl. connector	28 g/m
Weight sensor incl. male part connector	5,8 g
Connector type	Diam. 8, snap-on
Weight female part connector	1,8 g
Mounting	Attachment bracket
Material bracket	Anodised aluminium
Material screw	Stainless steel

**Ordering data**

Order code	Output	Cable connection	Cable length	Weight kg
<b>Reed sensors</b>				
9126344301	making	straight *)	3 m	0,08
9126344302	making	straight *)	10 m	0,23
9126344309	making	straight **)		0,01

**Attachment bracket for P1C-S**

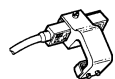

For reed and electronic sensors	Cylinder bore mm	
9126344361	32 to 40	0,02
9126344362	50 to 100	0,02
9126344363	125	0,02

**Attachment bracket for P1C-T**

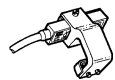

For reed and electronic sensors	Cylinder bore mm	
9126344391	32 to 63	0,20
9126344392	80 to 125	0,13

**Electronic sensors**

These sensors are of solid-state type, with no moving parts. Short-circuit and transient protection is incorporated as standard. The integral electronics make these sensors suitable for applications with very high switching frequencies and demands for extremely long service life.

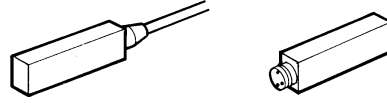

**Technical data**

Design	Inductive
Output	PNP, N.O.
Voltage range	10-30 VDC
Rippel	max ±5%
Voltage drop	max. 1,6 V
Load current	max. 200 mA
Breaking power (resistive)	max. 6 W
Capacitive load	max 0,33 µF
Internal consumption	10 mA
Actuating distance	min. 9 mm
Hysteresis	0,8 mm
Repeatability accuracy	±0,01 mm
On/off switching frequency	max. 500 Hz
On switching time	max. 0,8 ms
Off Switching time	max. 0,04 ms
Encapsulation	IP 67 (DIN 40 050)
Temperature range	-25 °C till +80 °C
Indication	LED, yellow
Material housing	PEI
Material mould	Epoxy
Weight sensor incl. 3 m cable	70 g
Cable	PVC 3x0.25 mm <sup>2</sup>
Weight cable excl. connector	28 g/m
Weight sensor incl. male part connector	6 g
Connector type	Diam. 8, snap-on
Weight female part connector	1,8 g
Mounting	Attachment bracket
Material bracket	Anodised aluminium
Material screw	Stainless steel

**Ordering data**

Order code	Output	Cable connection	Cable length	Weight kg
<b>Electronic sensors</b>				
9126344321	PNP, N.O.	straight *)	3 m	0,07
9126344322	PNP, N.O.	straight *)	10 m	0,22
9126344329	PNP, N.O.	straight **)		0,01

**Cables for sensors, complete with 8 mm round connector**

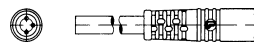

9126344341	Cable, Flex PVC, 3 m	0,07
9126344342	Cable, Flex PVC, 10 m	0,21
9126344343	Cable, Super Flex PVC, 3 m	0,07
9126344344	Cable, Super Flex PVC, 10 m	0,21
9126344345	Cable, Polyuretan, 3 m	0,01
9126344346	Cable, Polyuretan, 10 m	0,20

\* Encapsulated cable

\*\* Cable shall be ordered separately.

Symbols and dimensions, see page 32.

## Reed switch sensors

The reed switch sensors incorporate a well-proven, universal-voltage. This together with LED indication, two-wire connections and compact dimensions make them suitable for a wide range of applications. They can operate with PLC control systems as well as with conventional valves.



### Technical data

Design	Reed
Output	Making
Voltage range, 4621A och 4623A	10-240 VAC/300 VDC
Voltage range, 4631A	10-60 VAC/VDC
Voltage drop	max. 2,2 V
Load current	max. 0,5 A min. 2 mA
Breaking power (resistive)	max 50 W
Actuating distance	min. 9 mm
Hysteresis	1 mm
Repeatability accuracy	±0,01 mm
On/off switching frequency	max. 500 Hz
On switching time	max. 0,6 ms
Off switching time	max. 0,05 ms
Encapsulation	IP 67 (DIN 40 050)
Temperature range	-25 °C to +80 °C
Indication	LED, yellow
Material housing	PEI
Material mould	Epoxy
Weight sensor incl. 3 m cable	68 g
Cable	PVC 2x0.25 mm <sup>2</sup>
Weight cable excl. connector	28 g/m
Weight sensor incl. male part connector	5,8 g
Connector type	Diam. 8, snap-on
Weight female part connector	1,8 g
Mounting	Attachment bracket
Material bracket	Anodised aluminium
Material screw	Stainless steel

### Ordering data

Order code	Output	Cable connection	Cable length	Weight kg
<b>Reed sensors</b>				
<b>4621A</b>	making	straight *)	3 m	0,04
<b>4623A</b>	making	straight **)		0,01
<b>4631A</b>	making	straight **)		0,02

### Attachment bracket for P1C-S



For reed and electronic sensors	Cylinder bore mm	Weight kg
<b>873</b>	32 to 63	0,02
<b>874</b>	80 to 100	0,02

\* Encapsulated cable

\*\* Cable shall be ordered separately.

Symbols and dimensions, see page 32.

## Electronic sensor

This sensor is of solid-state type, with no moving parts. Short-circuit and transient protection is incorporated as standard. The integral electronics make this sensor suitable for applications with very high switching frequencies and demands for extremely long service life.

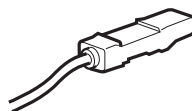

### Technical data

Design	Inductive
Output	PNP, N.O.
Voltage range 4630A	10-28 VDC
Rippel	max ±5%
Voltage drop	max. 1,6 V
Load current	max 400 mA
Breaking power (resistive)	max 12 W
Capacitive load	max 0,33 µF
Internal consumption	10 mA
Actuating distance	min. 9 mm
Hysteresis	0,8 mm
Repeatability accuracy	±0,01 mm
On/off switching frequency	max. 500 Hz
On switching time	max. 0,8 ms
Off switching time	max. 0,04 ms
Encapsulation	IP 67 (DIN 40 050)
Temperature range	-25 °C till +80 °C
Indication	LED, yellow
Material housing	PEI
Material mould	Epoxy
Weight sensor incl. 3 m cable	70 g
Cable	PVC 3x0.25 mm <sup>2</sup>
Weight cable excl. connector	28 g/m
Weight sensor incl. male part connector	6 g
Connector type	Diam. 8, snap-on
Weight female part connector	1,8 g
Mounting	Attachment bracket
Material bracket	Anodised aluminium
Material screw	Stainless steel

### Ordering data

Order code	Output	Cable connection	Cable length	Weight kg
<b>Electronic sensors</b>				
<b>4630A</b>	PNP, N.O.	straight*)	3 m	0,05

### Cables for sensors, complete with 8 mm round connector

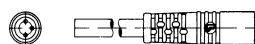

<b>9126344341</b>	Cable, Flex PVC, 3 m	0,07
<b>9126344342</b>	Cable, Flex PVC, 10 m	0,21
<b>9126344343</b>	Cable, Super Flex PVC, 3 m	0,07
<b>9126344344</b>	Cable, Super Flex PVC, 10 m	0,21
<b>9126344345</b>	Cable, Polyuret看, 3 m	0,01
<b>9126344346</b>	Cable, Polyuret看, 10 m	0,20

### Note

These sensors are used on cylinders fitted with guidance module.

## Dimensions

For P1C-S and P1C-T with reed or electronic sensors, type: 91263443 on page 30.

Cylinder bore mm	P1C-T			P1C-S		
	D mm	E mm	F mm	D mm	E mm	F mm
32	52	8	28	36	12	40
40	57	8	28	40	12	40
50	63	7	28	51	17	45
63	71	7	28	58	17	45
80	87	11	33	67	16	45
100	95	11	33	77	16	45
125	117	10	33	96	16	49

## Dimensions

For P1C-S with reed or electronic sensors, type: 46 on page 31.

Cylinder bore mm	P1C-S		
	D mm	E mm	F mm
32	39	12	38,5
40	43,5	12	38,5
50	47,5	14	43
63	55,5	14	43
80	72	20,5	54,5
100	83	20,5	54,5
125	95	21,5	57

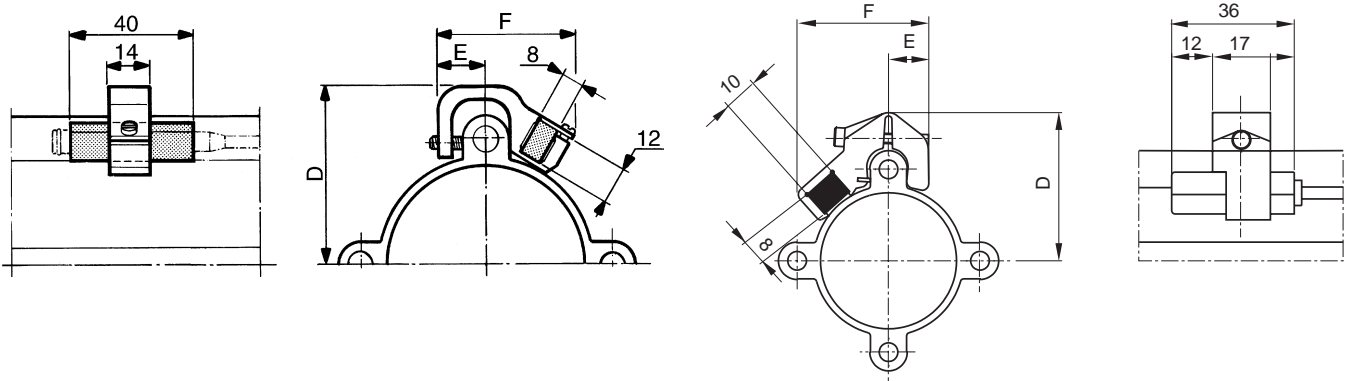

## Symbol reed sensor

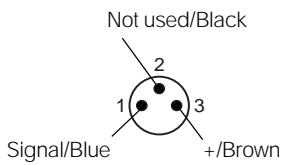
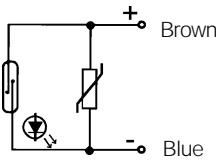

## Symbol electronic sensor

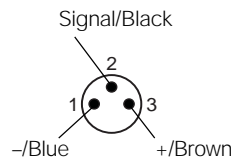
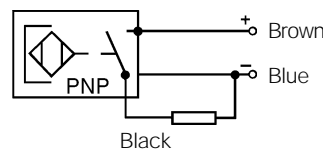

Colours according to cable	9126344341
	9126344342



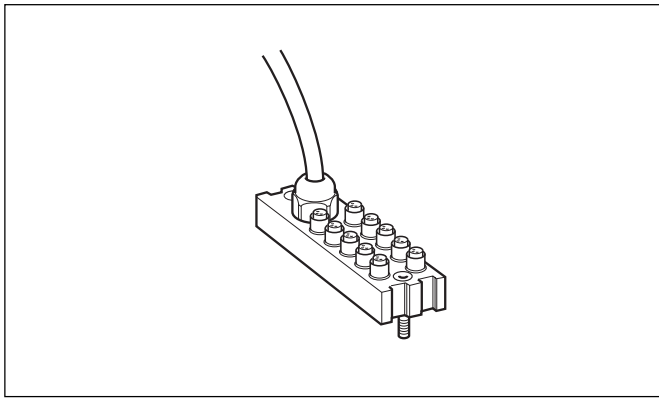

**Technical data, Valvetronic 110**

**Connections:**

Ten 3-pole numbered 8 mm round snap-in female contacts

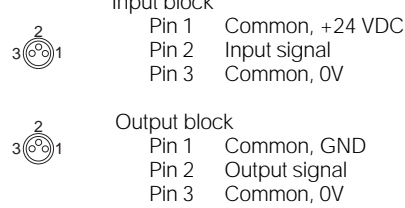

**Note!**  
When using reed contact, a special adapter cable has to be used. Order code 9121717030.

**The Valvetronic 110 connection block**

The Valvetronic 110 is a connection block that can be used for collecting signals from sensors at various points on a machine and connecting them to the control system via a multicore cable. It can also be used as a central point for connecting a multicore cable to the outputs of a control system, to provide a common point from where the output signals can be connected. The block has ten 8 mm snap-in round contacts and a 3 or 10 m multicore cable. The connections on the block are numbered from 1 to 10. Blanking plugs are available for unused connections, as labels for marking the connections of each block.

**Mechanical data**

Enclosure IP 67, DIN 40050 with fitted contacts and/or blanking plugs.  
Temperature -20 to +70 °C

**Material**

Body PA 6,6 VD according to UL 94  
Contact holder PBTP  
Snap-in ring LDPE  
Moulding mass Epoxy  
Seal NBR  
Screws Plated steel

**Cable:**

Length 3 m or 10 m  
Type of cable LiYY11Y  
Conductor 12  
Area 0.34 mm<sup>2</sup>  
Colour marking According to DIN 47 100

**Electrical data:**

Voltage 24 VDC (max. 60 V AC/75 V DC)  
Insulation group according to DIN 0110 class C  
Load max. 1 A per connection  
total max. 3 A

**Valvetronic 110**

Designation	Order code	Weight kg
Valvetronic 110 with 3 m cable	<b>9121719001</b>	0,32
Valvetronic 110 with 10 m cable	<b>9121719002</b>	0,95
Blanking plugs (pack of 10)	<b>9121719003</b>	0,02
Labels (pack of 10)	<b>9121719004</b>	0,02

**Industrial durability**

Good chemical and oil resistance. Tests should be performed in aggressive environments.



Use **blanking plugs** to close unused connections.



**White labels** to insert in grooves on the side of the connection

**Dimensions and wiring diagrams**

Conductor	Colour	Input	Output
1	Pink	Signal 1	Signal 1
2	Grey	Signal 2	Signal 2
3	Yellow	Signal 3	Signal 3
4	Green	Signal 4	Signal 4
5	White	Signal 5	Signal 5
6	Red	Signal 6	Signal 6
7	Black	Signal 7	Signal 7
8	Violet	Signal 8	Signal 8
9	Grey-Pink	Signal 9	Signal 9
10	Red-Blue	Signal 10	Signal 10
A	Blue	0 V	0 V
B	Brown	+24 V	PE

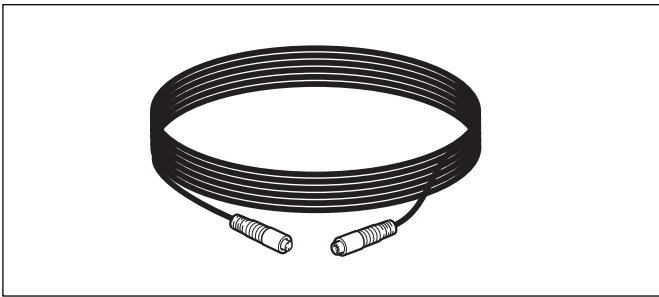

**Technical data**

**Contacts**

Mould-fitted 8 mm snap-in male/female contacts.  
Enclosure IP67

**Cable**

Conductor 3x0,25 mm<sup>2</sup> (32x0,10 mm<sup>2</sup>)  
Sheath PVC/PUR  
Colour Black

**Cables**

The Valvetronic System comprises a large number of different cables in order to meet all requirements that may arise and to make the installation simple, fast and reliable.

**Adapter cable for older reed relay contacts**

This is a cable for connection of older reed relay contacts to the system. One end has a straight 3 pole male contact and the other has a straight 3 pole female contact. Electrical connections are as follows: pin 1 to sleeve 1 and pin 2 to sleeve 3.

Note: Connecting an older reed relay contact directly to the system can cause a short circuit. It is therefore important always to check first that you have a new type reed relay contact with the correct pin connections, or to use the adapter cable (below) in order to ensure a correct signal to the system

Male connector      Female connector

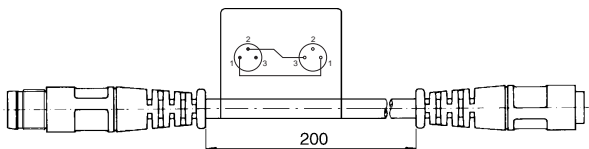

Designation	Order code	Weight kg
Adapter cable to older reed relay cont., 0,2 m	<b>9121717030</b>	0,03

**Ready-to-use cables**

Cables with mould-fitted 8 mm snap-in round contacts in both ends, The cables are available in two types, one with a straight male and female connectors respectively., and one with a straight 3-pole male connector in one end and an angled 3-pole female connector in the other end.

Cables with mould-fitted 8 mm snap-in round contacts in both ends, straight male and female connectors respectively.

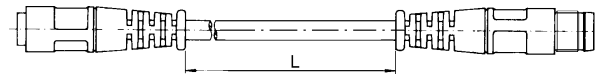

Designation	Order code	Weight kg
Cable with straight contacts, 0,2 m	<b>9121717014</b>	0,02
Cable with straight contacts, 0,3 m	<b>9121717015</b>	0,02
Cable with straight contacts, 0,5 m	<b>9121717016</b>	0,03
Cable with straight contacts, 1,0 m	<b>9121717017</b>	0,03
Cable with straight contacts, 2,0 m	<b>9121717018</b>	0,05
Cable with straight contacts, 3,0 m	<b>9121717019</b>	0,07
Cable with straight contacts, 5,0 m	<b>9121717020</b>	0,12
Cable with straight contacts, 10 m	<b>9121717021</b>	0,23

Cables with a straight 3-pole male connector in one end and an angled 3-pole female connector in the other end.

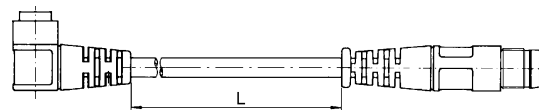

Designation	Order code	Weight kg
Cable with:		
straight and angled connectors, 0,2 m	<b>9121717022</b>	0,02
straight and angled connectors, 0,3 m	<b>9121717023</b>	0,02
straight and angled connectors, 0,5 m	<b>9121717024</b>	0,03
straight and angled connectors, 1,0 m	<b>9121717025</b>	0,03
straight and angled connectors, 2,0 m	<b>9121717026</b>	0,05
straight and angled connectors, 3,0 m	<b>9121717027</b>	0,07
straight and angled connectors, 5,0 m	<b>9121717028</b>	0,12
straight and angled connectors, 10 m	<b>9121717029</b>	0,23

## Seal kits for P1C

Complete seal kits consisting of:

- Scraper ring
- Piston rod bearing
- Piston rod seal
- Piston bearing
- Piston seals
- Cushioning rings
- O-rings

Material specification, see page 6

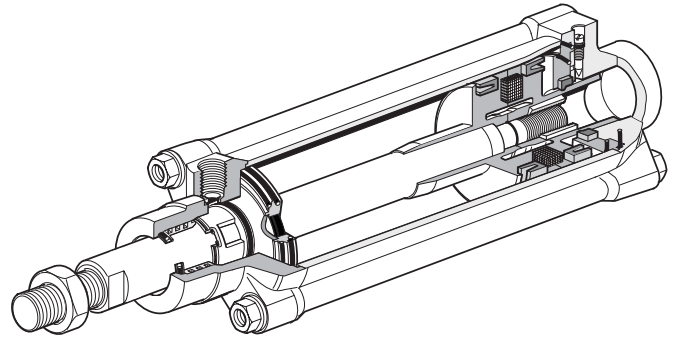

## Seal kits for complete P1C cylinder

Cyl. bore mm	Option			
	Standard	High Temp	Low Temp	Hydraulic
32	<b>9121715901</b>	<b>9121715931</b>	<b>9121715921</b>	<b>9121715961</b>
40	<b>9121715902</b>	<b>9121715932</b>	<b>9121715922</b>	<b>9121715962</b>
50	<b>9121715903</b>	<b>9121715933</b>	<b>9121715923</b>	<b>9121715963</b>
63	<b>9121715904</b>	<b>9121715934</b>	<b>9121715924</b>	<b>9121715964</b>
80	<b>9121715905</b>	<b>9121715935</b>	<b>9121715925</b>	<b>9121715965</b>
100	<b>9121715906</b>	<b>9121715936</b>	<b>9121715926</b>	<b>9121715966</b>
125	<b>9121715907</b>	<b>9121715937</b>	<b>9121715927</b>	<b>9121715967</b>

## Seal kits for complete P1C cylinder

Cyl. bore mm	Thru Rod	Rod Locking
	Standard	Standard
32	<b>9121715952</b>	<b>9121715941</b>
40	<b>9121715953</b>	<b>9121715942</b>
50	<b>9121715954</b>	<b>9121715943</b>
63	<b>9121715955</b>	<b>9121715944</b>
80	<b>9121715956</b>	<b>9121715945</b>
100	<b>9121715957</b>	<b>9121715946</b>
125	<b>9121715958</b>	<b>9121715947</b>

## Grease for P1C



Standard	30 g	<b>9127394541</b>
High temperature	30 g	<b>9127394521</b>
Low temperature	30 g	<b>9127394531</b>

# Service and Replacement Parts

---

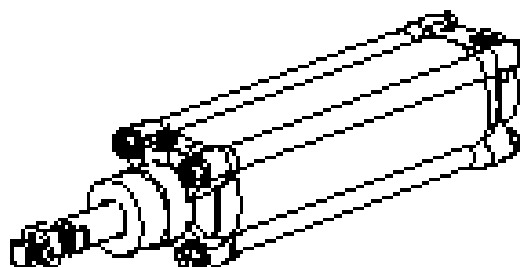

## P1C ISO/VDMA Cylinders

### Standard Cylinders

Part Number	Repair Kit
P1C-S032MS-XXXX	9121715901
P1C-S040MS-XXXX	9121715902
P1C-S050MS-XXXX	9121715903
P1C-S063MS-XXXX	9121715904
P1C-S080MS-XXXX	9121715905
P1C-S100MS-XXXX	9121715906
P1C-S125MS-XXXX	9121715907

### High Temperature Cylinders

Part Number	Repair Kit
P1C-S032MF-XXXX	9121715931
P1C-S040MF-XXXX	9121715932
P1C-S050MF-XXXX	9121715933
P1C-S063MF-XXXX	9121715934
P1C-S080MF-XXXX	9121715935
P1C-S100MF-XXXX	9121715936
P1C-S125MF-XXXX	9121715937