



p/n 88-017790-01 C

# Gemini Motor Reference Manual

Effective: November 1, 1999

---

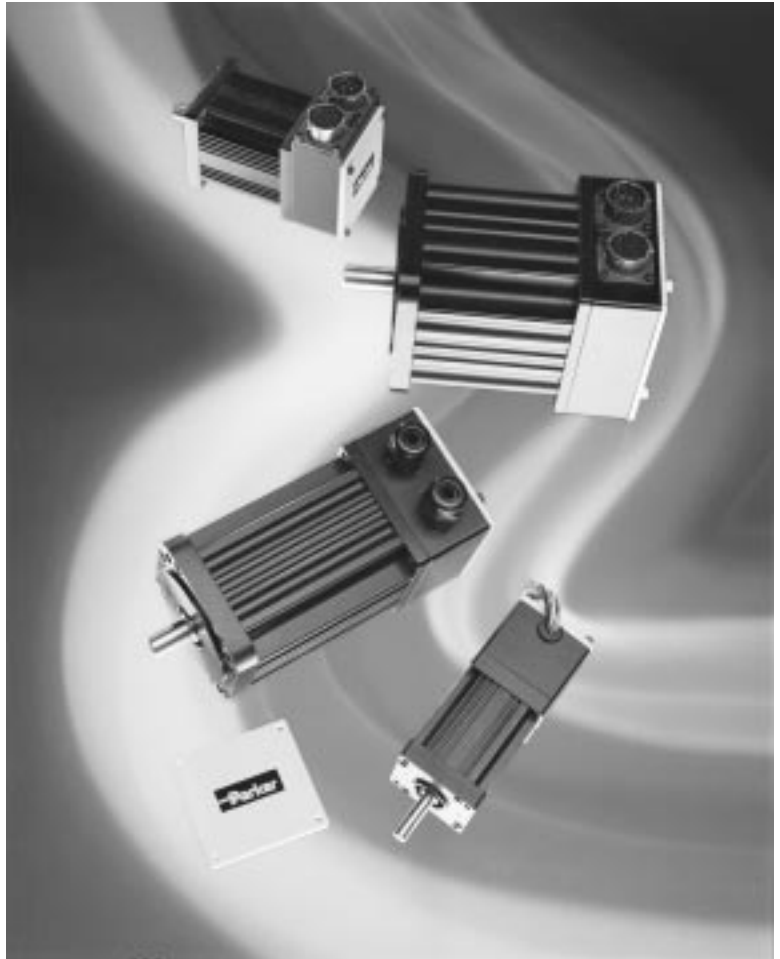

# IMPORTANT

## User Information



### WARNING



Gemini Series products are used to control electrical and mechanical components of motion control systems. You should test your motion system for safety under all potential conditions. Failure to do so can result in damage to equipment and/or serious injury to personnel.

Gemini Series products and the information in this user guide are the proprietary property of Parker Hannifin Corporation or its licensors, and may not be copied, disclosed, or used for any purpose not expressly authorized by the owner thereof.

Since Parker Hannifin constantly strives to improve all of its products, we reserve the right to change this user guide and software and hardware mentioned therein at any time without notice.

In no event will the provider of the equipment be liable for any incidental, consequential, or special damages of any kind or nature whatsoever, including but not limited to lost profits arising from or in any way connected with the use of the equipment or this user guide.

© 1999, Parker Hannifin Corporation  
All Rights Reserved

Motion Planner and Pocket Motion Planner are trademarks of Parker Hannifin Corporation.  
Microsoft and MS-DOS are registered trademarks, and Windows, Visual Basic, and Visual C++ are trademarks of Microsoft Corporation.

### Technical Assistance Contact your local automation technology center (ATC) or distributor, or ...

#### North America and Asia:

Compumotor Division of Parker Hannifin  
5500 Business Park Drive  
Rohnert Park, CA 94928  
Telephone: (800) 358-9070 or (707) 584-7558  
Fax: (707) 584-3793  
FaxBack: (800) 936-6939 or (707) 586-8586  
e-mail: [tech\\_help@cmotor.com](mailto:tech_help@cmotor.com)  
Internet: <http://www.compumotor.com>

#### Europe (non-German speaking):

Parker Digiplan  
21 Balena Close  
Poole, Dorset  
England BH17 7DX  
Telephone: +44 (0)1202 69 9000  
Fax: +44 (0)1202 69 5750

#### Germany, Austria, Switzerland:

HAUSER Elektronik GmbH  
Postfach: 77607-1720  
Robert-Bosch-Str. 22  
D-77656 Offenburg  
Telephone: +49 (0)781 509-0  
Fax: +49 (0)781 509-176

# Contents

<b>CHANGE SUMMARY .....</b>	<b>4</b>
<b>CHAPTER 1 – INTRODUCTION .....</b>	<b>5</b>
<b>CHAPTER 2 – ROTARY SERVO MOTORS .....</b>	<b>7</b>
Recommended Drive/Motor Systems .....	8
Part Numbering System .....	9
Speed/Torque Curves .....	10
Specifications .....	13
Dimensions .....	16
Wiring Information .....	18
Feedback Specifications .....	22
Electrically Released Brakes .....	22
Bearing Load and Life Information .....	23
<b>CHAPTER 3 – LINEAR SERVO MOTORS .....</b>	<b>25</b>
Rotary to Linear Conversion Table .....	26
Recommended Drive/Linear Servo Motor Table Systems .....	27
Part Numbering System – 406LXR Example .....	28
Speed/Force Curves .....	29
Motor Specifications .....	30
Table Specifications .....	31
Dimensions .....	32
Wiring Information .....	33
Feedback Specifications .....	36
Bearing Load and Life Information .....	37
<b>CHAPTER 4 – STEP MOTORS .....</b>	<b>39</b>
Recommended Drive/Motor Systems .....	40
Speed/Torque Curves .....	41
Specifications .....	45
Dimensions .....	49
Step Motor Wiring .....	53
Encoder Information .....	55

## Change Summary

---

### Gemini Motor Reference Manual

#### Revision C

November 1, 1999

The following is a summary of the primary technical changes to this document since the previous version was released. This document, part number 88-017790-01C, supersedes 88-017790-01B.

#### **Two Speed/Torque Curves Added** (page 12)

Speed/torque curves have been added for the NO923K/JO923K and NO924K motors, which are recommended for use with the Gemini GV-H20E Servo Drive

#### **Color Code Corrections** (page 35)

Minor corrections were made to the Hall 1/Hall 2/Hall 3 color codes for the following drawings:

- Gemini Adapter Cable
- Gemini Plug-In Connector Module.

Shields are now indicated in these drawings. The temperature switch wires for the Plug-In Connector Module is now *yellow*, instead of *yellow/orange*.

#### Revision B

July 30, 1999

The following is a summary of the primary technical changes to this document since the previous version was released. This document, part number 88-017790-01B, supersedes 88-017790-01A.

#### **Motor Parameter Table Removed** (pages 8 – 9)

The motor parameter table has been removed from Chapter 2 Servo Motors. Information about motor parameters can be found on the Motion Planner CD-ROM, and on Compumotor's web site.

#### **Linear Servo Motor Information Added**

Information about using linear servo motors with Gemini GV drives has been added. See *Chapter 3 – Linear Servo Motors*.

#### **Step Motor Information Added**

Information about using step motors with Gemini GT drives has been added. See *Chapter 4 – Step Motors*.

CHAPTER ONE

# Introduction

## Gemini Motor Reference Manual

---

Compumotor manufactures and sells a broad range of motors. This manual contains information about those Compumotor motors we recommend using with Gemini drives.

Topics in this manual include:

- Recommended Drive/Motor Systems
- Motor Part Numbering System
- Speed/Torque Curves
- Motor Specifications
- Dimensions
- Motor Cable Information
- Encoder Specifications
- Hall Effect Specifications
- Brake Specifications

The above information is provided for:

- Servo Motors (see *Chapter 2*)
- Linear Servo Motors (see *Chapter 3*)
- Step Motors (see *Chapter 4*)

CHAPTER TWO

# Rotary Servo Motors

## Recommended Drive/Motor Systems

---

We recommend you use the following motors with drives listed in the *Recommended Drive Type* column.

Motor Model Number	Recommended Drive Type
SM161A	GV-L3E
SM162A	GV-L3E
SM231A	GV-L3E
SM232A	GV-L3E
SM233A	GV-L3E
N0701D	GV-U6E
N0701F	GV-U6E
N0702E	GV-U6E
N0702F	GV-U6E
N0703F	GV-U6E
N0703G	GV-U12E
N0704F	GV-U6E
N0704G	GV-U12E
J0701D	GV-U6E
J0701F	GV-U6E
J0702E	GV-U6E
J0702F	GV-U6E
J0703F	GV-U6E
J0703G	GV-U12E
N0921F	GV-U6E
N0921G	GV-U12E
N0922G	GV-U12E
N0922J	GV-U12E
N0923H	GV-U12E
N0923K	GV-H20E
N0924J	GV-U12E
N0924K	GV-H20E
J0921F	GV-U6E
J0921G	GV-U12E
J0922G	GV-U12E
J0922J	GV-U12E
J0923H	GV-U12E
J0923K	GV-H20E



# Part Numbering System

NOTE: Diagrams list *all* motor options. Those options not compatible with Gemini drives are shown in parentheses.

## SM Series Motors

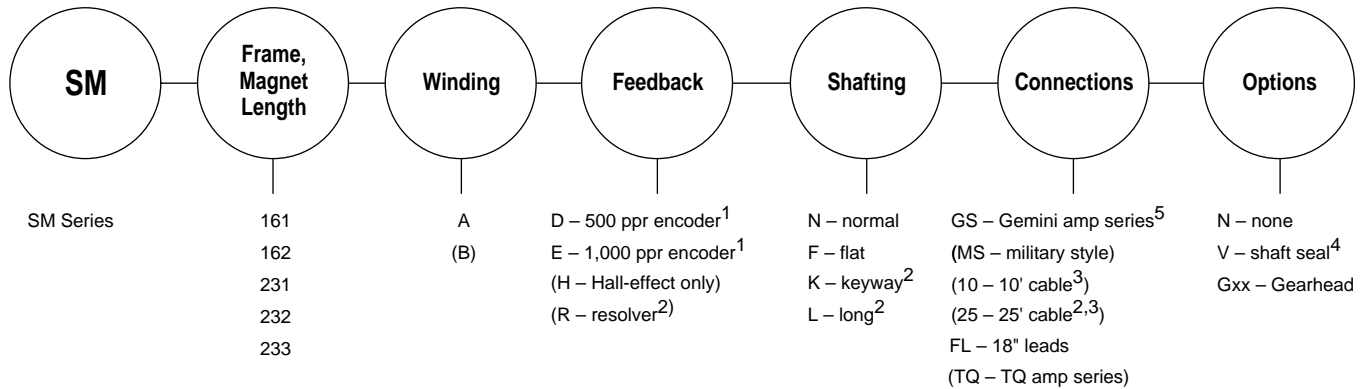

- 1 Includes Hall effect
- 2 Not available on size 16
- 3 Cable is hard wired

- 4 Sizes 16 and 23 with GS, MS, or TQ connectors—IP65
- 5 Specify GS connections for use with Gemini drives

## NeoMetric Series Motors

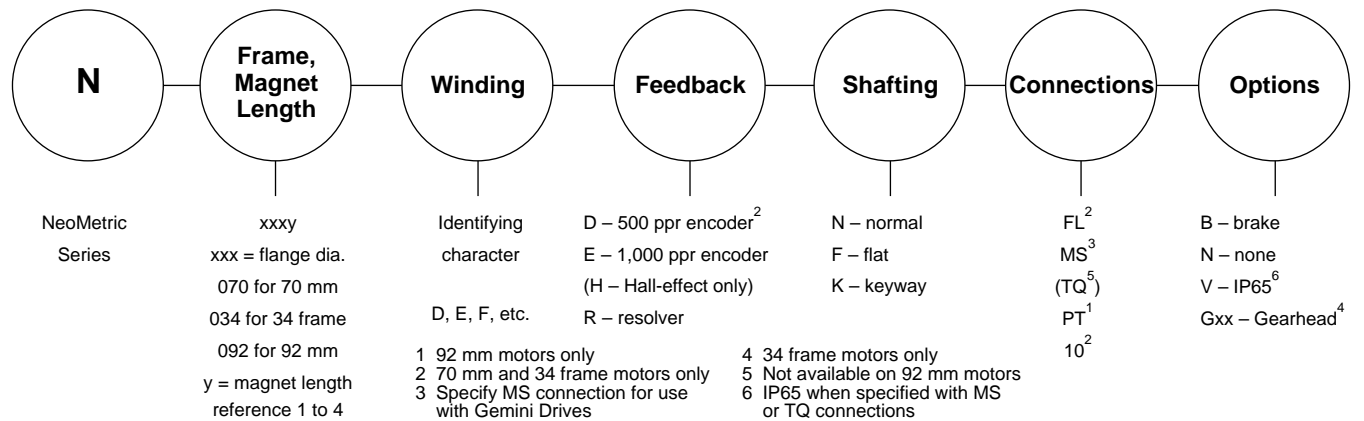

- 1 92 mm motors only
- 2 70 mm and 34 frame motors only
- 3 Specify MS connection for use with Gemini Drives
- 4 34 frame motors only
- 5 Not available on 92 mm motors
- 6 IP65 when specified with MS or TQ connections

Example: N0703FE-KMSB

## J Series Motors

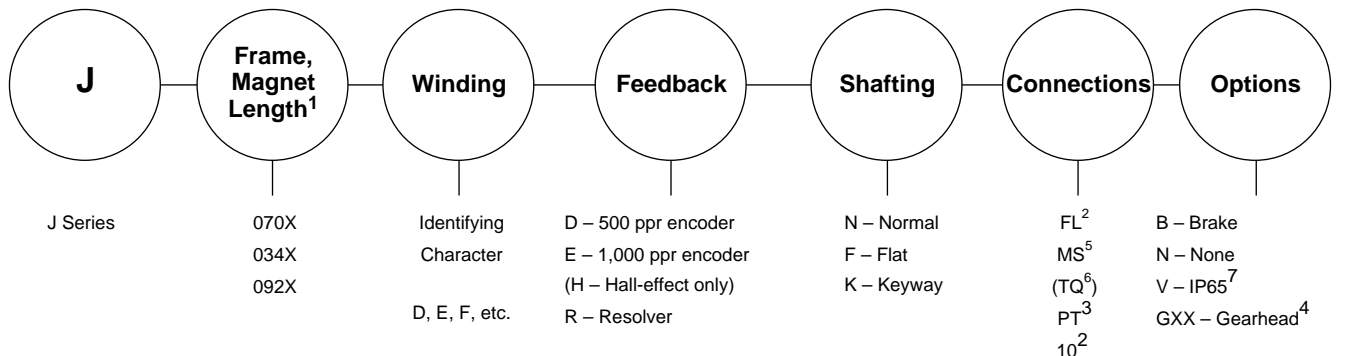

Example: J0702FE-KMSB

- 1 Four stack frame sizes not available in J Series
- 2 70 mm only
- 3 92 mm only

- 4 34 Frame motors only
- 5 Specify MS connection for use with Gemini drive
- 6 Not available on 92 mm motors
- 7 IP65 when specified with MS or TQ connection

# Speed/Torque Curves

## SM Series Motors, Encoder Feedback

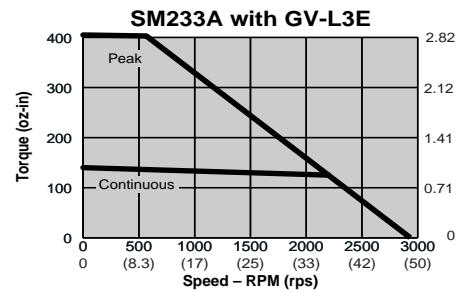
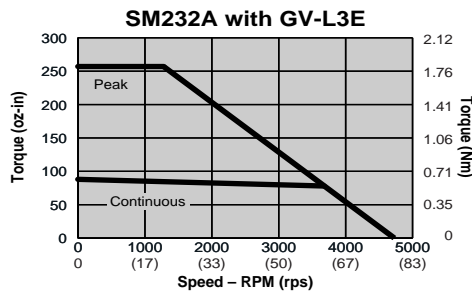
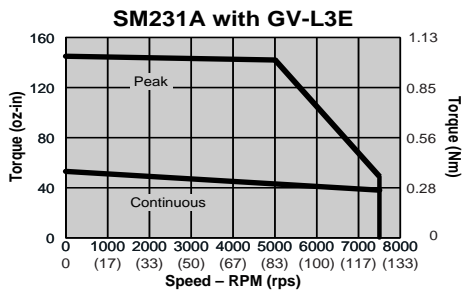
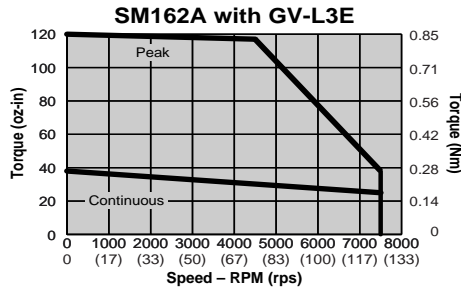
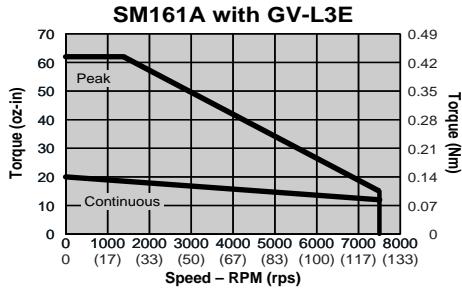

**NOTES:**

- For "E" encoder option (4,000 counts per revolution, post quadrature), maximum velocity is 6,000 rpm (100 rps).
- Speed/torque curves limited to 7,500 rpm (motor mechanical limit).
- Solid lines designate 120VAC operation, continuous and peak.
- Curves represent 120VAC (nominal) operation.
- Actual speed/torque curves may vary  $\pm 10\%$
- Speed/torque curves are based on motor current values listed in *Motor Parameter Table*, available on the Motion Planner CD-ROM and on the Compumotor web site.
- For speed/torque curves of motors that may have been released after this manual was published, see the *Gemini Motor Reference* section of the Compumotor web site.

**NeoMetric Series Motors, 70 mm and 34 Frame, Encoder Feedback**  
**J Series Motors, 70 mm and 34 Frame, Encoder Feedback**

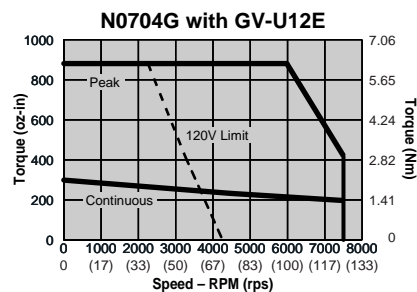
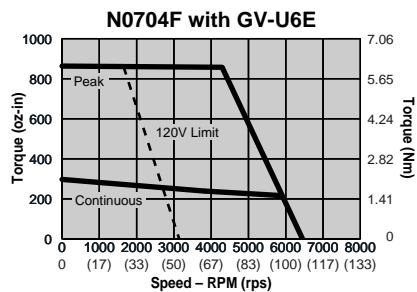
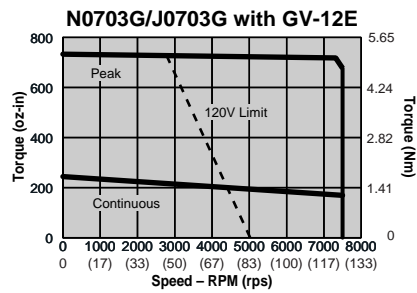
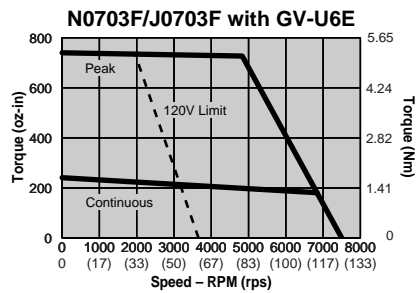
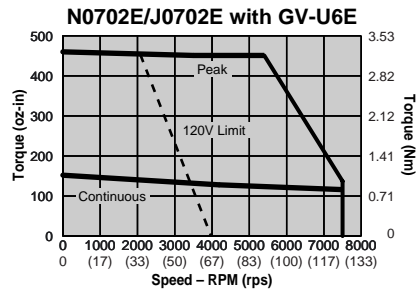
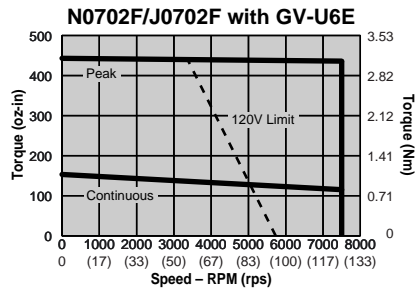
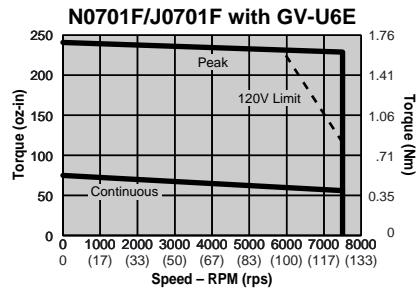
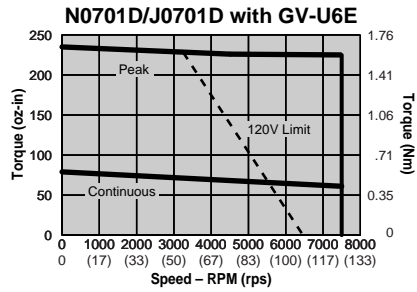

**NOTES:**

- For "E" encoder option (4,000 counts per revolution, post quadrature), maximum velocity is 6,000 rpm (100 rps).
- Speed/torque curves limited to 7,500 rpm (motor mechanical limit).
- Solid lines designate 240VAC operation, continuous and peak.
- Dashed line designates 120VAC speed limit.
- Curves represent 120VAC (nominal) and 240VAC (nominal) operation.
- Actual speed/torques may vary  $\pm 10\%$
- Speed/torque curves are based on motor current values listed in *Motor Parameter Table*, available on the Motion Planner CD-ROM and on the Compumotor web site.
- For speed/torque curves of motors that may have been released after this manual was published, see the *Gemini Motor Reference* section of the Compumotor web site.

NeoMetric Series Motors, 92 mm, Encoder Feedback  
 J Series Motors, 92 mm, Encoder Feedback

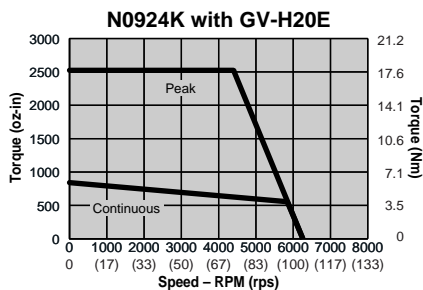
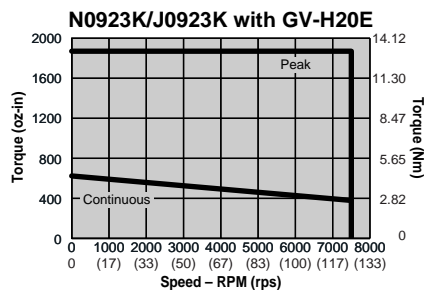
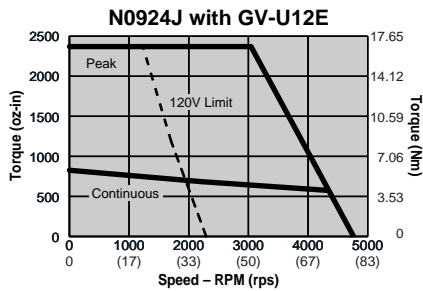
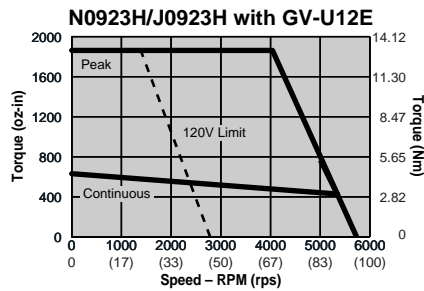
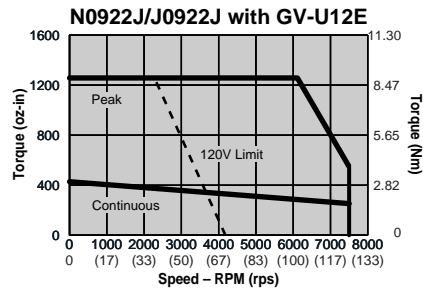
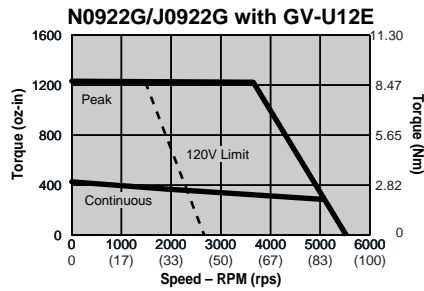
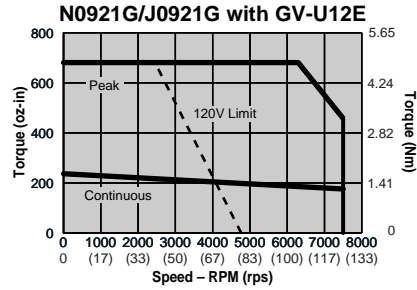
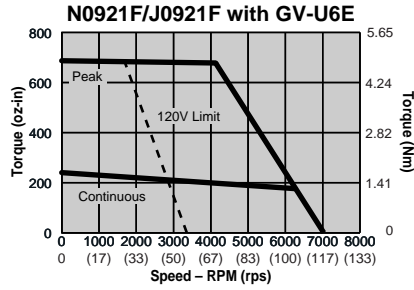

NOTES:

- For "E" encoder option (4,000 counts per revolution, post quadrature), maximum velocity is 6,000 rpm (100 rps).
- Speed/torque curves limited to 7,500 rpm (motor mechanical limit).
- Solid lines designate 240VAC operation, continuous and peak.
- Dashed line designates 120VAC speed limit.
- Curves represent 120VAC (nominal) and 240VAC (nominal) operation.
- Actual speed/torques may vary  $\pm 10\%$
- Speed/torque curves are based on motor current values listed in *Motor Parameter Table*, available on the Motion Planner CD-ROM and on the Compumotor web site.
- For speed/torque curves of motors that may have been released after this manual was published, see the *Gemini Motor Reference* section of the Compumotor web site.

# Specifications

Data listed is for motor only. Drive specifications may change some values.

## SM Series, 16 Frame and 23 Frame, Encoder Feedback [10]

Parameter:	Symbol:	Units:	SM161A	SM162A	SM231A	SM232A	SM233A
Stall Torque Continuous [1]	Tcs	lb-in	1.6	2.9	3.8	6.6	10.1
		oz-in	26	47	61	106	161
		Nm	0.18	0.33	0.43	0.74	1.13
Stall Current Continuous [1, 4, 8]	Ics(sine)	Amps Peak	2.7	2.6	2.9	2.8	2.7
Stall Current Continuous [1, 7]	Ics(trap)	Amps DC	2.3	2.3	2.5	2.4	2.4
Peak Torque [6]	Tpk	lb-in	4.9	8.8	11.3	19.8	30.2
		oz-in	78	141	181	316	483
		Nm	0.55	0.99	1.27	2.21	3.38
Peak Current [4, 6, 8]	lpk(sine)	Amps Peak	8.1	7.8	8.8	8.3	8.1
Peak Current [6, 7]	lpk(trap)	Amps DC	7.0	6.8	7.6	7.2	7.1
Rated Speed [2]	Wr	rpm	7500	7500	7500	7500	5800
Current @ Rated Speed	Ir(sine)	Amps	2.2	2.2	2.5	2.3	2.4
Current @ Rated Speed	Ir(trap)	Amps	1.9	1.9	2.2	2.0	2.0
Torque @ Rated Speed	Tr	lb-in	1.1	2.3	2.9	5.1	8.1
		oz-in	18	37	47	81	129
		Nm	0.13	0.26	0.33	0.57	0.90
Shaft Power @ Rated Speed	Po	watts	97	205	261	449	553
Voltage Constant [3, 4]	Kb	Volts/rad/s	0.079	0.147	0.169	0.310	0.484
Voltage Constant [3, 4]	Ke	Volts/KRPM	8.27	15.39	17.70	32.46	50.68
Torque Constant [9]	Kt(sine)	oz-in/Amp Peak	9.69	18.03	20.72	38.02	59.35
		Nm/Amp Peak	0.068	0.126	0.145	0.266	0.415
Torque Constant [3, 4]	Kt(trap)	oz-in/Amps DC	11.19	20.82	23.93	43.90	68.53
		Nm/Amp DC	0.078	0.146	0.168	0.307	0.480
Resistance [3]	R	Ohms	4.53	6.50	5.22	7.50	9.65
Inductance [5]	L	mH	0.81	1.39	1.64	2.90	4.08
Maximum Bus Voltage	Vm	Volts DC	170	170	170	340	340
Thermal Resistance Wind-Amb	Rth w-a	C/watt	2.70	2.00	2.00	1.54	1.25
Thermal Resistance Wind-Case	Rth w-c	C/watt	1.19	0.78	0.85	0.51	0.37
Motor Constant	Km	oz-in/sqrt(watt)	5.26	8.16	10.47	16.03	22.06
		Nm/sqrt(watt)	0.037	0.057	0.073	0.112	0.154
Viscous Damping	B	oz-in/Krpm	0.284	0.300	0.250	0.360	0.540
		mNm/Krpm	1.99	2.10	1.75	2.52	3.78
Static Friction	Tf	oz-in	0.15	0.20	0.30	0.70	1.00
		mNm	1.05	1.40	2.10	4.90	7.00
Motor Thermal Time Constant	Tau_th	minutes	11.6	14.2	20	21.6	23.3
Winding Thermal Time Const	Tau_wnd	minutes	0.33	0.33	0.33	0.33	0.33
Electrical Time Constant	Tau_elec	millisecs	0.18	0.21	0.31	0.39	0.42
Mechanical Time Constant	Tau_mch	millisecs	7.7	5.5	9.5	7.2	5.4
Intermittent Torque Duration [10]	T_2x	seconds	9	14	11	18	20
Peak Torque Duration [11]	T_3x	seconds	4	5	4	6	7
Rotor Inertia	J	lb-in-sec <sup>2</sup>	0.000094	0.000163	0.00046	0.00082	0.00117
		oz-in <sup>2</sup>	0.58	1.01	2.84	5.07	7.23
		kg-m <sup>2</sup>	0.0000106	0.0000184	0.000052	0.000093	0.000132
Number of Poles	Np		4	4	4	4	4
Weight	#	lbs	1.1	1.6	2.1	3.0	3.9
		kg	0.5	0.7	1.0	1.4	1.8
Winding Class			H	H	H	H	H

1 @ 25C ambient, 125C winding temperature, motor connected to a 10"x10"x1/4" aluminum mounting plate.

@40C ambient derate phase currents and torques by 12%.

2 Maximum speed is 7500 RPM with 500 line Encoder. For 1000 line encoders, derate to 6000RPM.

For higher speed operation please call the factory.

3 Measured Line to Line, +/- 10%.

4 Value is measured peak of sine wave.

5 +/-30%, Line-to-Line, inductance bridge measurement @1Khz.

6 Initial winding temperature must be 60 C or less before Peak Current is Applied.

7 DC current through a pair of motor phases of a trapazoidally (six state) commutated motor.

8 Peak of the sinusoidal current in any phase for a sinusiodally comutated motor.

9 Total motor torque per peak of the sinusiodal amps measured in any phase, +/-10%.

10 Data listed is for motor only. Drive specifications may change some values.

## NeoMetric Series/J Series, 70 mm and 34 Frame, Encoder Feedback [10]

Parameter:	Symbol:	Units:	N0701D or N0341D	N0701F or N0341F	N0702E or N0342E	N0702F or N0342F	N0703F or N0343F	N0703G or N0343G	N0704F or N0344F	N0704G or N0344G
Stall Torque Continuous [1]	Tcs	lb-in	5.7	5.6	10.4	10.4	15.8	15.8	19.5	19.5
		oz-in	91	90	167	166	252	252	311	312
		Nm	0.63	0.63	1.17	1.16	1.77	1.77	2.18	2.19
Stall Current Continuous [1, 4, 8]	Ics(sine)	Amps Peak	3.3	5.2	3.8	5.4	5.2	7.3	5.4	7.5
Stall Current Continuous [1, 7]	Ics(trap)	Amps DC	2.9	4.5	3.3	4.6	4.5	6.3	4.7	6.5
Peak Torque [6]	Tpk	lb-in	17.0	16.8	31.2	31.1	47.3	47.3	58.4	58.6
		oz-in	272	269	500	498	757	757	934	937
		Nm	1.90	1.88	3.50	3.49	5.30	5.30	6.54	6.56
Peak Current [4, 6, 8]	lpk(sine)	Amps Peak	10.0	15.6	11.5	16.1	15.7	21.9	16.3	22.6
Peak Current [6, 7]	lpk(trap)	Amps DC	8.7	13.5	10.0	13.9	13.6	19.0	14.1	19.6
Rated Speed [2]	W <sub>r</sub>	rpm	7500	7500	7500	7500	6800	7500	5500	7500
Current @ Rated Speed	I <sub>r</sub> (sine)	Amps	3.0	4.7	3.2	4.5	4.4	5.8	4.6	5.6
Current @ Rated Speed	I <sub>r</sub> (trap)	Amps	2.6	4.1	2.8	3.9	3.8	5.0	4.0	4.9
Torque @ Rated Speed	T <sub>r</sub>	lb-in	4.7	4.6	7.1	7.9	10.8	11.4	14.1	12.6
		oz-in	75	74	114	126	173	182	226	201
		Nm	0.53	0.52	0.80	0.88	1.21	1.27	1.58	1.41
Shaft Power @ Rated Speed	P <sub>o</sub>	watts	416	411	632	699	870	1010	919	1115
Voltage Constant [3, 4]	K <sub>b</sub>	Volts/rad/s	0.221	0.140	0.353	0.253	0.392	0.282	0.468	0.338
Voltage Constant [3, 4]	K <sub>e</sub>	Volts/KRPM	23.14	14.66	36.97	26.49	41.05	29.53	49.01	35.40
Torque Constant [9]	K <sub>t</sub> (sine)	oz-in/Amp Peak	27.10	17.17	43.29	31.03	48.07	34.58	57.39	41.45
		Nm/Amp Peak	0.190	0.120	0.303	0.217	0.336	0.242	0.402	0.290
Torque Constant [3, 4]	K <sub>t</sub> (trap)	oz-in/Amp DC	31.29	19.82	49.98	35.82	55.51	39.93	66.27	47.86
		Nm/Amp DC	0.219	0.139	0.350	0.251	0.389	0.280	0.464	0.335
Resistance [3]	R	Ohms	5.52	2.27	5.22	2.70	3.36	1.74	3.47	1.80
Inductance [5]	L	mH	12.98	5.23	15.80	8.16	12.13	6.30	14.50	7.55
Maximum Bus Voltage	V <sub>m</sub>	Volts DC	340	340	340	340	340	340	340	340
Thermal Res Wind-Amb	R <sub>th w-a</sub>	C/watt	1.44	1.44	1.15	1.15	0.96	0.96	0.87	0.87
Thermal Res Wind-Case	R <sub>th w-c</sub>	C/watt	0.66	0.66	0.39	0.39	0.24	0.24	0.21	0.21
Motor Constant	K <sub>m</sub>	oz-in/sqrt(watt)	13.32	13.16	21.88	21.80	30.28	30.27	35.57	35.67
		Nm/sqrt(watt)	0.093	0.092	0.153	0.153	0.212	0.212	0.249	0.250
Viscous Damping	B	oz-in/Krpm	0.2	0.2	0.4	0.4	0.6	0.6	0.8	0.8
		mNm/krpm	1.4	1.4	2.8	2.8	4.2	4.2	5.6	5.6
Static Friction	T <sub>f</sub>	oz-in	0.8	0.8	1.6	1.6	2.4	2.4	3.2	3.2
		mNm	5.6	5.6	11.2	11.2	16.8	16.8	22.4	22.4
Motor Thermal Time Constant	Tau <sub>th</sub>	minutes	16.6	16.6	21.7	21.7	22.5	22.5	23.3	23.3
Winding Thermal Time Const	Tau <sub>wnd</sub>	minutes	0.66	0.66	0.58	0.58	0.53	0.53	0.5	0.5
Electrical Time Constant	Tau <sub>elec</sub>	milliseconds	2.35	2.30	3.03	3.02	3.61	3.62	4.18	4.19
Mechanical Time Constant	Tau <sub>mch</sub>	milliseconds	1.6	1.7	0.6	0.6	0.6	0.6	0.6	0.6
Intermittent Torque Duration [10]	T <sub>2x</sub>	seconds	22	22	32	32	39	39	38	38
Peak Torque Duration [11]	T <sub>3x</sub>	seconds	9	9	11	11	13	13	12	12
Rotor Inertia	J	lb-in-sec <sup>2</sup>	0.000106	0.000106	0.000173	0.000173	0.00024	0.00024	0.000307	0.000307
		oz-in <sup>2</sup>	0.65	0.65	1.07	1.07	1.48	1.48	1.90	1.90
		kg-m <sup>2</sup>	0.0000120	0.0000120	0.0000195	0.0000195	0.0000271	0.0000271	0.0000347	0.0000347
Number of Poles	N <sub>p</sub>		4	4	4	4	4	4	4	4
Weight	#	lbs	3.5	3.5	4.5	4.5	6.0	6.0	7.3	7.3
		kg	1.6	1.6	2.1	2.1	2.7	2.7	3.3	3.3
Winding Class			H	H	H	H	H	H	H	H

1 @ 25C ambient, 125C winding temperature, motor connected to a 10"x10"x1/4" aluminum mounting plate.

@40C ambient derate phase currents and torques by 12%.

2 Maximum speed is 7500 RPM with 500 line Encoder. For 1000 line encoders, derate to 6000RPM.

For higher speed operation please call the factory.

3 Measured Line to Line, +/- 10%.

4 Value is measured peak of sine wave.

5 +/-30%, Line-to-Line, inductance bridge measurement @1Khz.

6 Initial winding temperature must be 60 C or less before Peak Current is Applied.

7 DC current through a pair of motor phases of a trapaziodally (six state) commutated motor.

8 Peak of the sinusiodal current in any phase for a sinusiodally comutated motor.

9 Total motor torque per peak of the sinusiodal amps measured in any phase, +/-10%.

10 Data listed is for motor only. Drive specifications may change some values.

Additional J Series Specifications: Parameter:	Symbol:	Units:	N0701D or N0341D	N0701F or N0341F	N0702E or N0342E	N0702F or N0342F	N0703F or N0343F	N0703G or N0343G
Rotor Inertia	J	lb-in-sec <sup>2</sup>	0.00114	0.00114	0.00121	0.00121	0.00128	0.00128
		oz-in <sup>2</sup>	7.04	7.04	7.47	7.47	7.91	7.91
		kg-m <sup>2</sup>	0.0001288	0.0001288	0.0001367	0.0001367	0.0001446	0.0001446
Mechanical Time Constant	Tau <sub>mch</sub>	milliseconds	14.7	14.7	5.7	5.7	3.2	3.2
Weight	#	lbs	4.4	4.4	5.4	5.4	6.9	6.9
		kg	2.0	2.0	2.5	2.5	3.1	3.1

## NeoMetric Series/J Series, 92 mm, Encoder Feedback [10]

Parameter:	Symbol:	Units:	N0921F	N0921G	N0922G	N0922J	N0923H	N0923K	N0924J	N0924K
Stall Torque Continuous [1]	Tcs	lb-in	15.5	15.6	27.6	28.3	41.3	40.6	54.6	54.8
		oz-in	249	249	442	453	660	650	873	876
		Nm	1.74	1.74	3.09	3.17	4.62	4.55	6.11	6.14
Stall Current Continuous [1, 4, 8]	Ics(sine)	Amps Peak	4.7	6.6	6.5	10.1	10.0	17.4	10.8	15.2
Stall Current Continuous [1, 7]	Ics(trap)	Amps DC	4.1	5.7	5.6	8.7	8.6	15.1	9.4	13.2
Peak Torque [6]	Tpk	lb-in	46.6	46.7	82.9	83.5	268.8	468.8	163.8	164.3
		oz-in	746	747	1327	1336	4300	7500	2620	2629
		Nm	5.22	5.23	9.29	9.35	30.10	52.50	18.34	18.41
Peak Current [4, 6, 8]	lpk(sine)	Amps Peak	14.2	19.7	19.5	30.3	29.9	52.2	32.5	45.6
Peak Current [6, 7]	lpk(trap)	Amps DC	12.3	17.1	26.9	26.2	25.9	45.2	28.2	39.5
Rated Speed [2]	W <sub>r</sub>	rpm	6000	7500	4650	7300	4689	7500	3750	5250
Current @ Rated Speed	l <sub>r</sub> (sine)	Amps	4.1	5.2	5.6	7.0	8.6	11.9	9.7	12.4
Current @ Rated Speed	l <sub>r</sub> (trap)	Amps	3.5	4.5	4.8	6.0	7.4	10.3	8.4	10.7
Torque @ Rated Speed	T <sub>r</sub>	lb-in	11.8	11.3	20.4	16.3	30.4	28.8	41.0	39.1
		oz-in	188	181	326	260	487	461	656	626
		Nm	1.32	1.27	2.28	1.82	3.41	3.23	4.59	4.38
Shaft Power @ Rated Speed	P <sub>o</sub>	watts	834	1004	1121	1404	1689	2557	1820	2431
Voltage Constant [3, 4]	K <sub>b</sub>	Volts/rad/s	0.427	0.309	0.556	0.360	0.540	0.305	0.657	0.470
Voltage Constant [3, 4]	K <sub>e</sub>	Volts/KRPM	44.72	32.36	58.22	37.70	56.55	31.94	68.80	49.22
Torque Constant [9]	K <sub>t</sub> (sine)	oz-in/Amp Peak	52.36	37.89	68.18	44.15	66.22	37.40	80.57	57.64
		Nm/Amp Peak	0.367	0.265	0.477	0.309	0.464	0.262	0.564	0.403
Torque Constant [3, 4]	K <sub>t</sub> (trap)	oz-in/Amp DC	60.46	43.75	78.73	50.98	76.46	43.19	93.03	66.55
		Nm/Amp DC	0.423	0.306	0.551	0.357	0.535	0.302	0.651	0.466
Resistance [3]	R	Ohms	3.72	1.94	2.32	0.96	1.28	0.42	1.22	0.62
Inductance [5]	L	mH	17.11	8.99	14.72	6.18	14.95	4.78	20.60	10.51
Maximum Bus Voltage	V <sub>m</sub>	Volts DC	340	340	340	340	340	340	340	340
Thermal Res Wind-Amb	R <sub>th w-a</sub>	C/watt	1.06	1.06	0.91	0.91	0.7	0.7	0.62	0.62
Thermal Res Wind-Case	R <sub>th w-c</sub>	C/watt	0.30	0.30	0.23	0.23	0.14	0.14	0.10	0.10
Motor Constant	K <sub>m</sub>	oz-in/sqrt(watt)	31.35	31.41	51.69	52.03	67.59	66.64	84.23	84.52
		Nm/sqrt(watt)	0.219	0.220	0.362	0.364	0.473	0.466	0.590	0.592
Viscous Damping	B	oz-in/Krpm	0.5	0.5	0.8	0.8	1.1	1.1	1.4	1.4
		mNm/krpm	3.5	3.5	5.6	5.6	7.7	7.7	9.8	9.8
Static Friction	T <sub>f</sub>	oz-in	2.5	2.5	4.8	4.8	5.4	5.4	6.6	6.6
		mNm	17.5	17.5	33.6	33.6	37.8	37.8	46.2	46.2
Motor Thermal Time Constant	Tau <sub>th</sub>	minutes	21.6	21.6	30	30	35	35	37	37
Winding Thermal Time Const	Tau <sub>wnd</sub>	minutes	0.8	0.8	0.5	0.5	0.5	0.5	0.4	0.4
Electrical Time Constant	Tau <sub>elec</sub>	milliseconds	4.60	4.63	6.34	6.44	11.68	11.38	16.89	16.95
Mechanical Time Constant	Tau <sub>mch</sub>	milliseconds	0.8	0.8	0.5	0.5	0.4	0.5	0.4	0.4
Intermittent Torque Duration [10]	T <sub>2x</sub>	seconds	48	48	39	39	61	61	61	61
Peak Torque Duration [11]	T <sub>3x</sub>	seconds	17	17	13	13	16	16	15	15
Rotor Inertia	J	lb-in-sec <sup>2</sup>	0.000363	0.000363	0.000623	0.000623	0.000883	0.000883	0.00114	0.00114
		oz-in <sup>2</sup>	2.24	2.24	3.85	3.85	5.45	5.45	7.04	7.04
		kg-m <sup>2</sup>	0.0000410	0.0000410	0.0000704	0.0000704	0.0000998	0.0000998	0.0001288	0.0001288
Number of Poles	N <sub>p</sub>		4	4	4	4	4	4	4	4
Weight	#	lbs	8.1	8.1	11.7	11.7	15.1	15.1	18.0	18.0
		kg	3.7	3.7	5.3	5.3	6.9	6.9	8.2	8.2
Winding Class			H	H	H	H	H	H	H	H

1 @ 25C ambient, 125C winding temperature, motor connected to a 10"x10"x1/4" aluminum mounting plate.

@40C ambient derate phase currents and torques by 12%.

2 Maximum speed is 7500 RPM with 500 line Encoder. For 1000 line encoders, derate to 6000RPM.

For higher speed operation please call the factory.

3 Measured Line to Line, +/- 10%.

4 Value is measured peak of sine wave.

5 +/-30%, Line-to-Line, inductance bridge measurement @1Khz.

6 Initial winding temperature must be 60 C or less before Peak Current is Applied.

7 DC current through a pair of motor phases of a trapezoidally (six state) commutated motor.

8 Peak of the sinusoidal current in any phase for a sinusoidally commutated motor.

9 Total motor torque per peak of the sinusoidal amps measured in any phase, +/-10%.

10 Data listed is for motor only. Drive specifications may change some values.

## Additional J Series Specifications

Parameter:	Symbol:	Units:	N0921F	N0921G	N0922G	N0922J	N0923H	N0923K
Rotor Inertia	J	lb-in-sec <sup>2</sup>	0.00423	0.00423	0.00450	0.00450	0.00480	0.00480
		oz-in <sup>2</sup>	26.13	26.13	27.80	27.80	29.65	29.65
		kg-m <sup>2</sup>	0.0004779	0.0004779	0.0005084	0.0005084	0.0005423	0.0005423
Mechanical Time Constant	Tau <sub>mch</sub>	milliseconds	10.0	10.0	3.9	3.9	2.4	2.4
Weight	#	lbs	9.9	9.9	13.5	13.5	16.9	16.9
		kg	4.5	4.5	6.1	6.1	7.7	7.7

# Dimensions

## SM Series, 16 Frame, Encoder Feedback

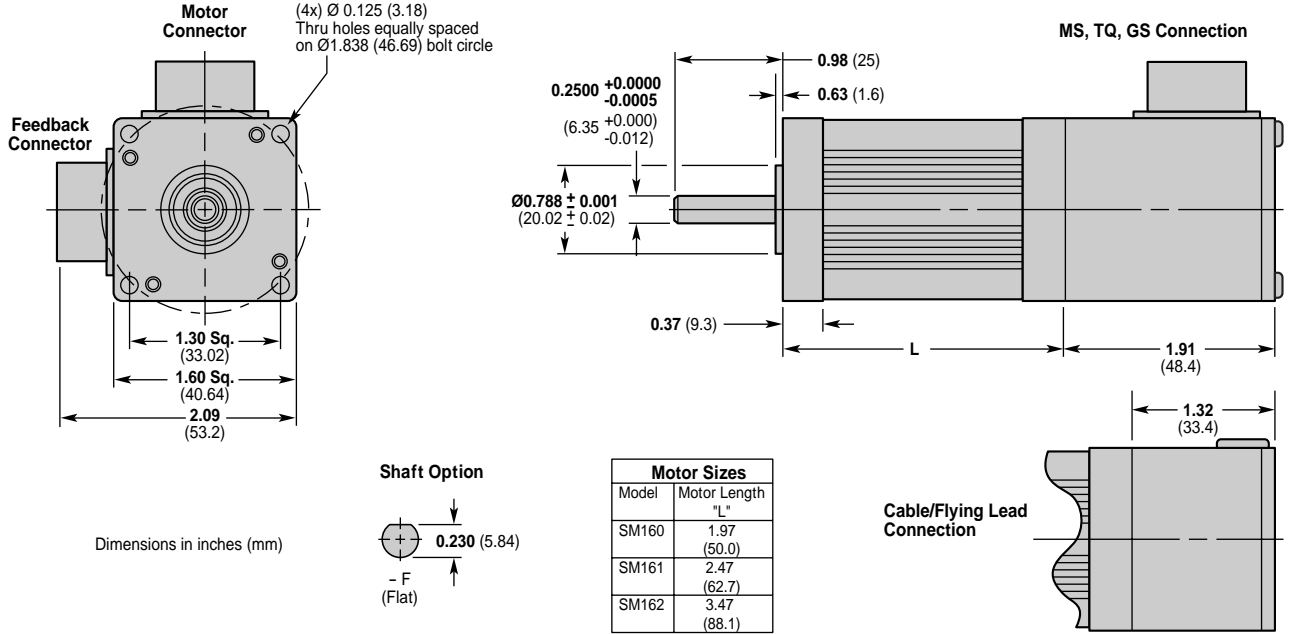

## SM Series, 23 Frame, Encoder Feedback

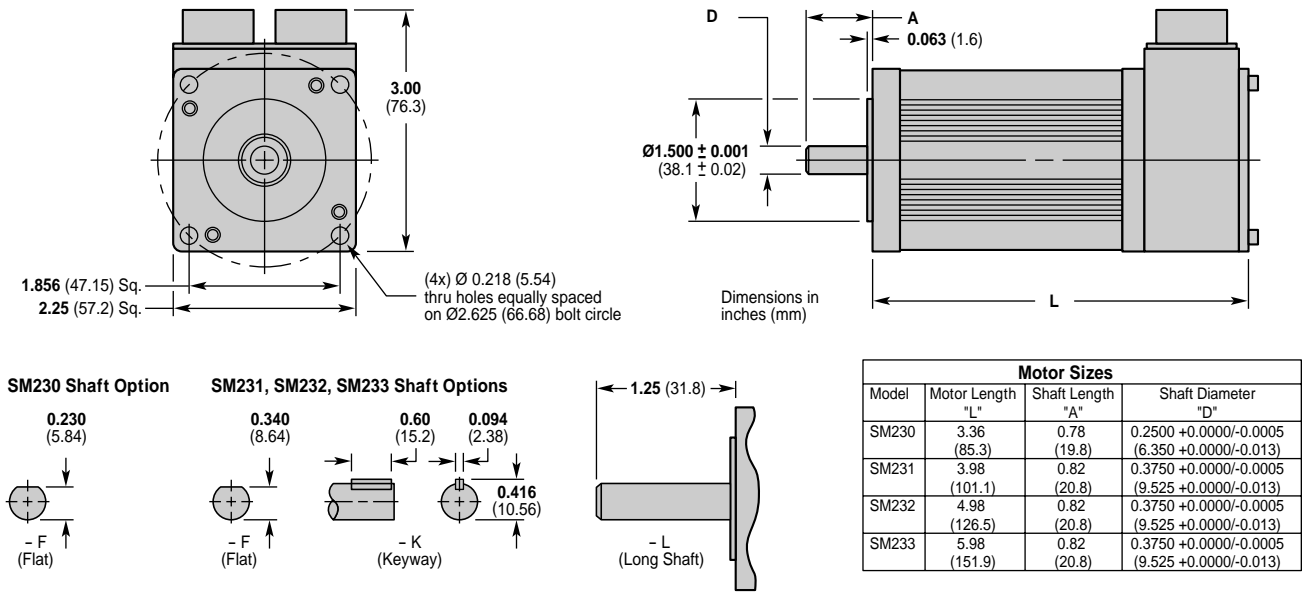



### NeoMetric Series and J Series, Size 70

4 x  $\varnothing 0.228$  (5.8) Thru Holes  
Eq Spaced on a  $\varnothing 2.953$  (75.00)  
Bolt Circle for 5mm or #10 Bolt

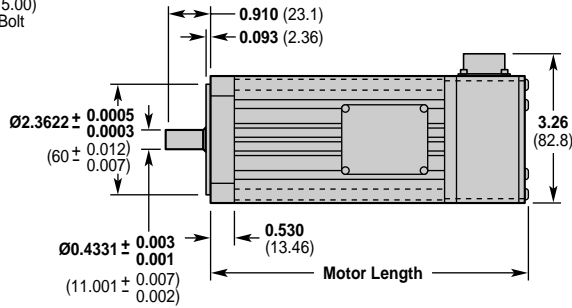
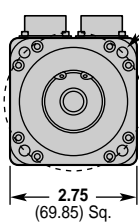

Motor Sizes		
Motor Length	NeoMetric	J Series
10.00 (254.00)	70-4 Brake	J0703 Brake
9.00 (228.60)	70-3 Brake	J0702 Brake
8.00 (203.20)	70-2 Brake	J0701 Brake
7.00 (177.80)	70-1 Brake	
7.94 (201.68)	70-4	J0703
6.94 (176.28)	70-3	J0702
5.94 (150.88)	70-2	J0701
4.94 (125.48)	70-1	

Dimensions in inches (mm)

Shaft Options

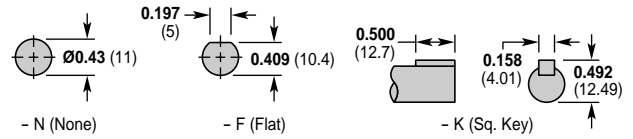

### NeoMetric Series and J Series, Size 34

4 x  $\varnothing 0.223$  (5.66) Thru Holes  
Eq Spaced on a  $\varnothing 3.875$  (98.43)  
Bolt Circle for 5mm or #10 Bolt

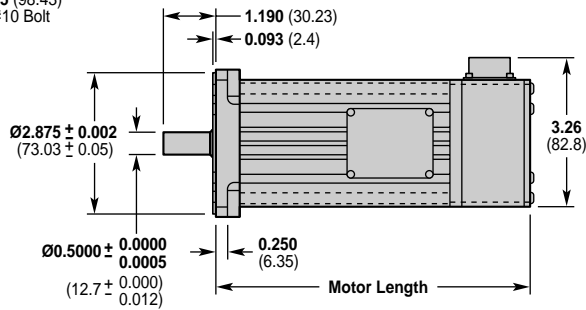
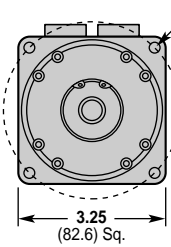

Motor Sizes		
Motor Length	NeoMetric	J Series
10.00 (254.00)	34-4 Brake	J0343 Brake
9.00 (228.60)	34-3 Brake	J0342 Brake
8.00 (203.20)	34-2 Brake	J0341 Brake
7.00 (177.80)	34-1 Brake	
7.94 (201.68)	34-4	J0343
6.94 (176.28)	34-3	J0342
5.94 (150.88)	34-2	J0341
4.94 (125.48)	34-1	

Dimensions in inches (mm)

Shaft Options

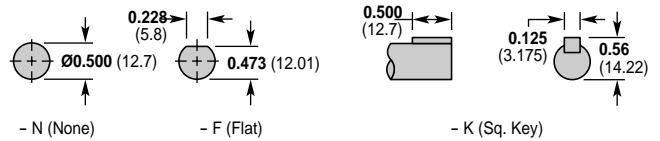

### NeoMetric Series and J Series, Size 92

4 x  $\varnothing 0.281$  (7.14) Thru Holes  
Eq Spaced on a  $\varnothing 3.937$  (100)  
Bolt Circle for 6mm or 1/4" Bolt

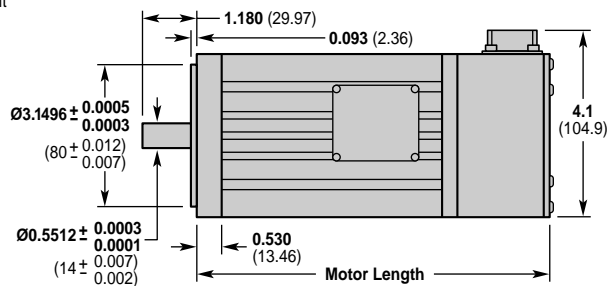
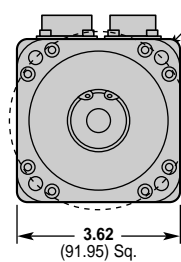

Motor Sizes		
Motor Length	NeoMetric	J Series
13.50 (342.90)	92-4 Brake	J0923 Brake
12.00 (304.80)	92-3 Brake	J0922 Brake
10.50 (266.70)	92-2 Brake	J0921 Brake
9.00 (228.60)	92-1 Brake	
11.13 (282.70)	92-4	J0923
9.63 (244.60)	92-3	J0922
8.13 (206.50)	92-2	J0921
6.63 (168.40)	92-1	

Note: For PT option  
add 1.40 inches

Dimensions in inches (mm)

Shaft Options

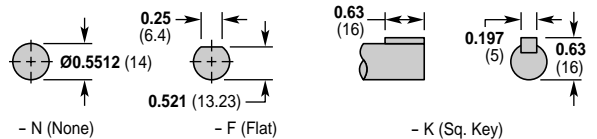

## Wiring Information

---

### SM Series, 16 Frame and 23 Frame, Encoder Feedback – Cable Sets

Specify the GS connection option when operating SM motors with Gemini drives. The GS option provides quick disconnect, bayonet style connectors attached to the motor body. Wiring for the GS option is similar to the MS option, except the temperature switch leads have been moved to the feedback connector.

The following cable sets are available for SM Series motors with the GS connection option. These cable sets consist of one motor power cable and one feedback cable. These cables have mating motor connectors at one end, and molded connectors for wiring to a Gemini drive at the other end. These cables have a braided metal shield and are CE (EMC) compliant. The GB cable sets have leads for wiring SM motors with internal brakes; the GS cable sets do not.

**23GS CABLE-XX** One set of cables for SM motors with encoder feedback and GS connection option. Gemini connector end does not have brake leads. "-XX" is cable length. "23GS CABLE" sets available in lengths of 10, 25, 35 feet.

**23GB CABLE-XX** One set of cables for SM motors with encoder feedback and GS connection option. Gemini connector end has two brake leads. "-XX" is cable length. "23GB CABLE" sets available in lengths of 10, 25, 35 feet.

Use these cables on 16 frame motors, as well as 23 frame size motors.

### NeoMetric Series and J Series, 70 mm and 34 Frame, Encoder Feedback – Cable Sets

Specify the MS connection option when operating 70 mm NeoMetric or J Series motors with Gemini drives.

The following cable sets are available for NeoMetric or J Series motors with the MS connection option. These cable sets consist of one motor power cable and one feedback cable. These cables have mating motor connectors at one end, and molded connectors for wiring to a Gemini drive at the other end. These cables have a braided metal shield and are CE (EMC) compliant. The GB cable sets have leads for wiring motors with internal brakes; the GS cable sets do not.

**70GS CABLE-XX** One set of cables for 70 mm motors with encoder feedback and MS connection option. Gemini connector end does not have brake leads. "-XX" is cable length. "70GS CABLE" sets available in lengths of 10, 25, 35 feet.

**70GB CABLE-XX** One set of cables for 70 mm motors with encoder feedback and MS connection option. Gemini connector end has two brake leads. "-XX" is cable length. "70GB CABLE" sets available in lengths of 10, 25, 35 feet.

Use these cables on 34 frame size motors, as well as 70 mm motors

### NeoMetric Series and J Series, 92 mm, Encoder Feedback – Cable Sets

Specify the MS connection option when operating 92 mm NeoMetric Series motors with Gemini drives.

The following cable sets are available for 92 mm NeoMetric Series motors with the MS connection option. These cable sets consist of one motor power cable and one feedback cable. These cables have mating motor connectors at one end, and molded connectors for wiring to a Gemini drive at the other end. These cables have a braided metal shield and are CE (EMC) compliant. The GB cable sets have leads for wiring motors with internal brakes; the GS cable sets do not.

**92GS CABLE-XX** One set of cables for 92 mm motors with encoder feedback and MS connection option. Gemini connector end does not have brake leads. "-XX" is cable length. "92GS CABLE" sets available in lengths of 10, 25, 35 feet.

**92GB CABLE-XX** One set of cables for 92 mm motors with encoder feedback and MS connection option. Gemini connector end has two brake leads. "-XX" is cable length. "92GB CABLE" sets available in lengths of 10, 25, 35 feet.

**Feedback Cable – Specifications**

This cable is supplied as the feedback cable with the following cable sets

<b>Without Brake Wires:</b>	<b>With Brake Wires:</b>
<b>23GS CABLE-XX</b>	<b>23GB CABLE-XX</b>
<b>70GS CABLE-XX</b>	<b>70GB CABLE-XX</b>
<b>92GS CABLE-XX</b>	<b>92GB CABLE-XX</b>

Cable color code, dimensions, and specifications are shown below.

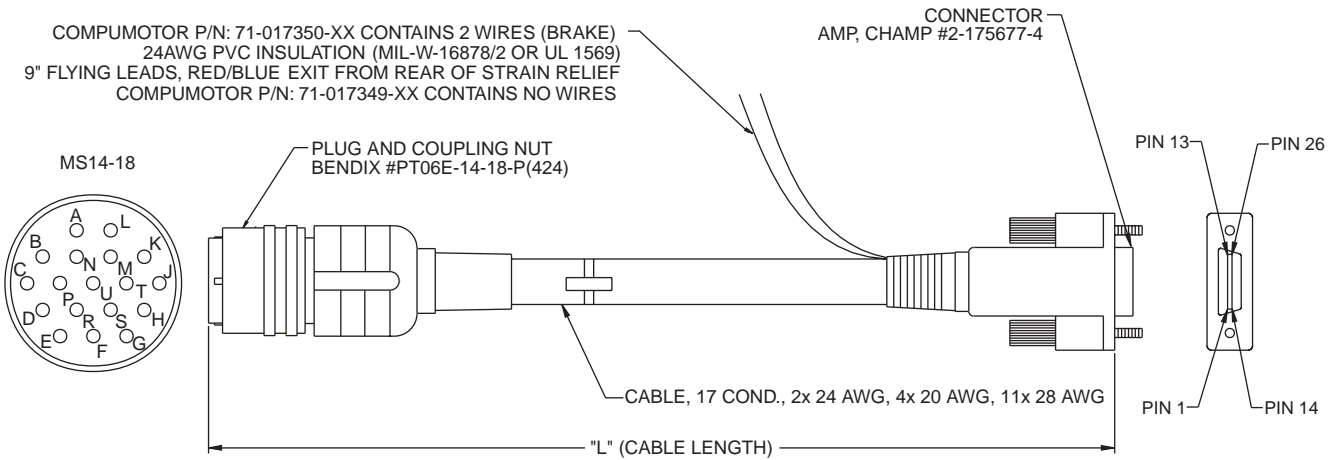

WIRE LIST			
MS14-18 PIN NO.	WIRE COLOR	FUNCTION	AMP CHAMP
ENCODER WIRES			
A	WHITE	CH A+	5
B	YELLOW	CH A-	6
C	GREEN	CH B+	7
D	BLUE	CH B-	8
E	ORANGE	INDEX+	9
F	BROWN	INDEX-	10
G	BLACK	GROUND	3,4
H	RED	+5V	1,2
HALL SIGNAL WIRES			
K	WHT/GRN	HALL GND	15,11
M	WHT/BLU	HALL +5V	14
P	WHT/VIO	HALL CH3	18
T	WHT/BRN	HALL CH1	16
U	WHT/ORG	HALL CH2	17
BRAKE & TEMP SW			
R	RED/BLUE	BRAKE (OPTIONAL)	N/A
S	RED/BLUE	BRAKE (OPTIONAL)	N/A
L	YEL/ORG	THERMAL SWITCH	12
N	YEL/ORG	THERMAL SWITCH	13

CABLE LENGTH	
DASH NO. (-XX)	DIM "L"
-10	10 FT. (3.0 m)
-25	25 FT. (7.6 m)
-35	35 FT. (10.6 m)

COMPUMOTOR CABLE P/N WITH 2 WIRES  
FOR BRAKE CONNECTION: 71-017350-XX

COMPUMOTOR CABLE P/N W/O 2 WIRES: 71-017349-XX

**Motor Cable for SM Series Motors – Specifications**

This cable is supplied as the motor cable with the following cable sets

**23GS CABLE-XX    23GB CABLE-XX**

Cable color code, dimensions, and specifications are shown below.

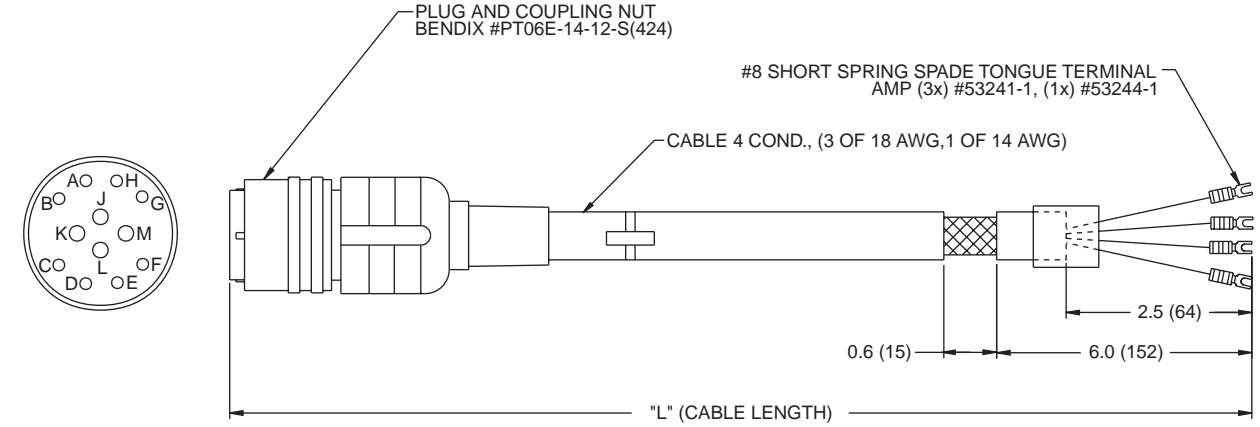

MS 14-12 CONNECTOR		
PIN NO.	WIRE COLOR	DRIVE
J	BLACK #1	U
K	BLACK #2	V
L	BLACK #3	W
M	GRN/YEL	⏚

CABLE LENGTH	
DASH NO. (-XX)	DIM "L"
-10	10 FT. (3.0 m)
-25	25 FT. (7.6 m)
-35	35 FT. (10.6 m)

**COMPUMOTOR CABLE P/N: 71-017093-XX**

**Motor Cable for NeoMetric and J Series, 70 mm and 34 Frame Motors – Specifications**

This cable is supplied as the motor cable with the following cable sets

**70GS CABLE-XX    70GB CABLE-XX**

Cable color code, dimensions, and specifications are shown below.

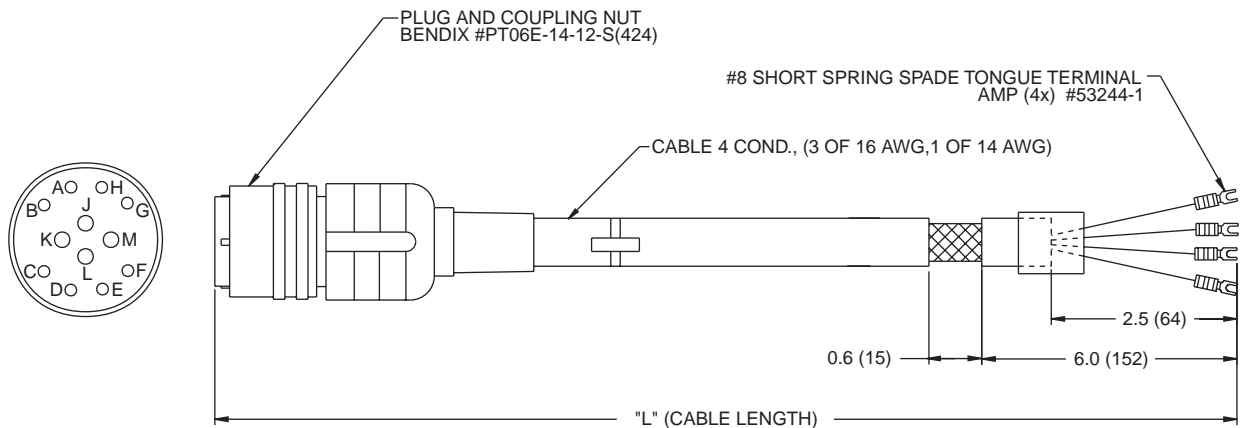

MS 14-12 CONNECTOR		
PIN NO.	WIRE COLOR	DRIVE
J	BLACK #1	U
K	BLACK #2	V
L	BLACK #3	W
M	GRN/YEL	⏚

CABLE LENGTH	
DASH NO. (-XX)	DIM "L"
-10	10 FT. (3.0 m)
-25	25 FT. (7.6 m)
-35	35 FT. (10.6 m)

**COMPUMOTOR CABLE P/N: 71-017094-XX**

**Motor Cable for NeoMetric and J Series, 92 mm Motors – Specifications**

This cable is supplied as the motor cable with the following cable sets

**92GS CABLE-XX 92GB CABLE-XX**

Cable color code, dimensions, and specifications are shown below.

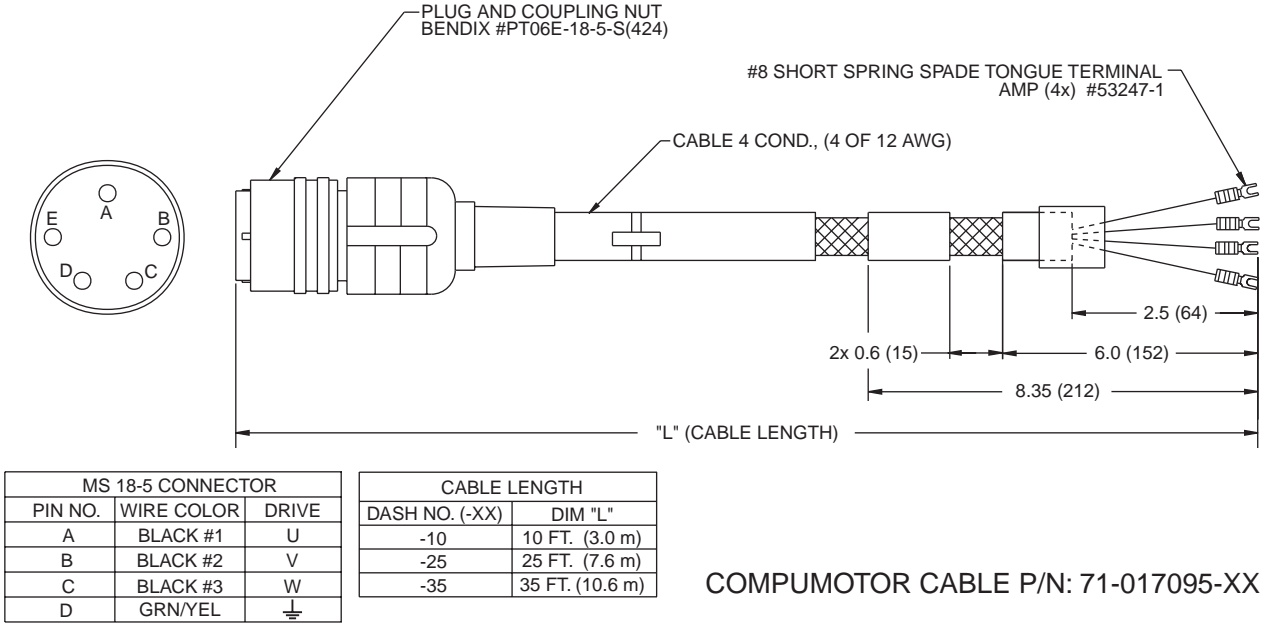

# Feedback Specifications

## Encoder Specifications – SM Series, NeoMetric Series, J Series

### Mechanical

Accuracy ±2 min of arc

### Electrical

Input Power 5VDC ±5%, 135mA  
 Operating frequency 100 kHz max  
 Output device 26LS31  
 Sin/Source, nominal 20mA  
 Suggested user interface 26LS32

## Hall Effect Specifications – SM Series, NeoMetric Series, J Series

### Electrical

Input Power 5VDC ±5%, 80mA  
 Output device LM339  
 open collector  
 Maximum pull up 12VDC  
 Sink 16mA

## Commutation Chart – SM Series, NeoMetric Series, J Series

Clockwise rotation as viewed from front shaft

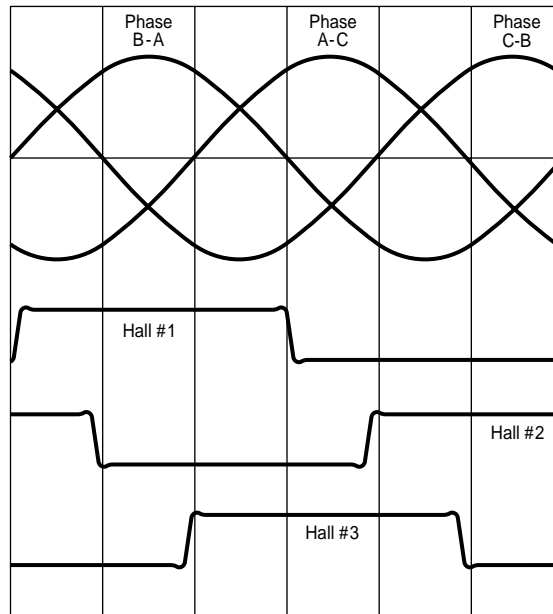

# Electrically Released Brakes

## NeoMetric Series Motors

Brakes	70 mm or 34 Frame	92 mm
Static rated torque	24 in-lb; 384 oz-in; (2.69 Nm)	72 in-lb; 1152 oz-in; (8.06 Nm)
Coil voltage	24VDC	24VDC
Coil Current	0.8 amps	0.52 amps
Weight	1.0 lbs (0.45 kg)	2.51 lbs (1.13 kg)
Inertia	0.000038 lb-in-sec <sup>2</sup> ; 0.23 oz-in <sup>2</sup> (0.0000043 kg-m <sup>2</sup> )	0.00015 lb-in-sec <sup>2</sup> ; 0.93 oz-in <sup>2</sup> (.0000169 kg-m <sup>2</sup> )

# Bearing Load and Life Information

## SM Series Motors

Compumotor's SM Series and NeoMetric Series motors use ABEC5, double-shielded, pre-lubricated bearings. Bearing life is directly affected by radial and axial loading, along with operating speed. Engineering charts provide L10 life estimations for listed radial and axial forces applied to the motor shaft. This data includes the internal bearing preload and is for the shortest length motor in each frame. Longer motors will exhibit longer L10 life.

**Motor Bearing System Life**

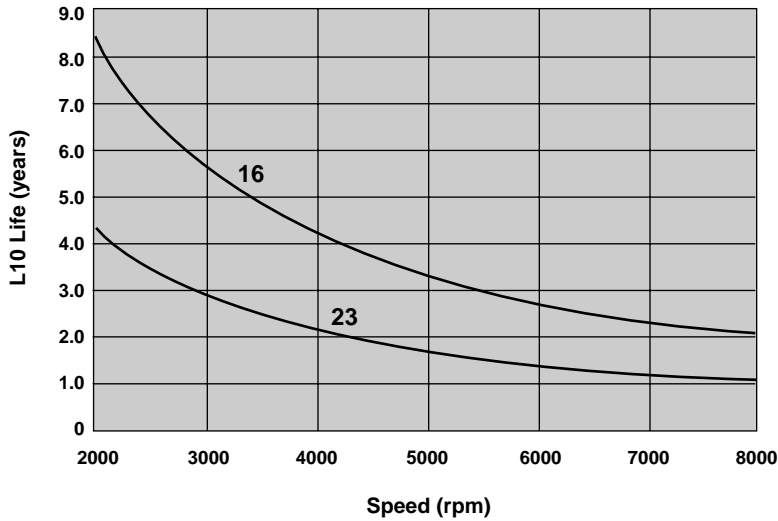

	Axial lbs (kg)	Radial lbs (kg)
16	10 (4.5)	10 (4.5)
23	15 (6.75)	10 (4.5)

## NeoMetric Series Motors and J Series Motors

**Motor Bearing System Life**

Fr=10#, Fa=10#

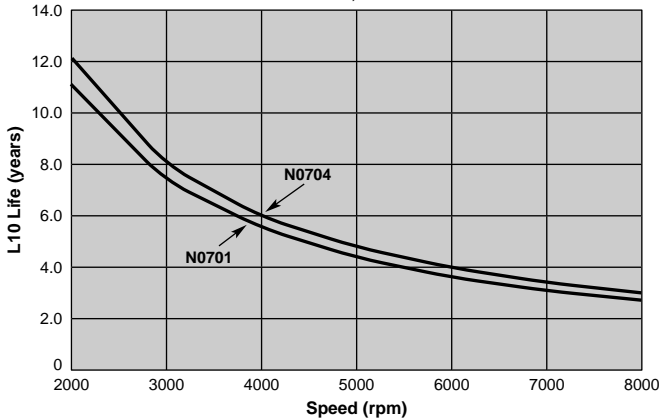

**70 mm or 34 Frame Bearing Chart**

**Motor Bearing System Life**

Fr=10#, Fa=10#

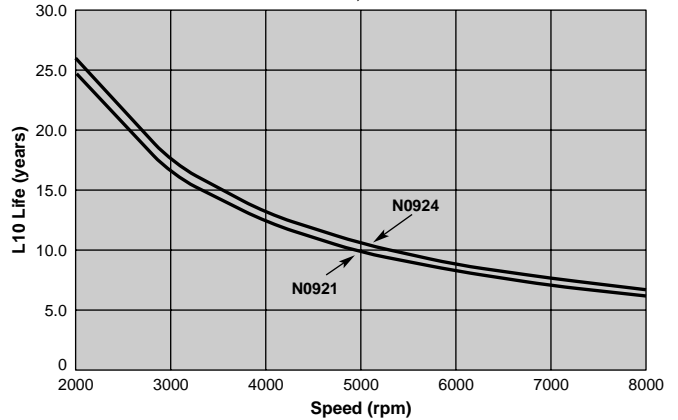

**92 mm Bearing Chart**





CHAPTER THREE

# 3 Linear Servo Motors

# Rotary to Linear Conversion Table

This table contains units for rotary to linear conversions of drive configuration parameters.

Parameter	Linear Units (Rotary Units)	Software Parameter	SL05508-A-N	SL05512-A-N	406-LXR-M-D13-E2	406-LXR-M-D13-E3	406-LXR-M-D13-E4	406-LXR-M-D13-E5	406-LXR-M-D15-E2	406-LXR-M-D15-E3	406-LXR-M-D15-E4	406-LXR-M-D15-E5
Motor ID Number	-	<b>DMTR</b>	1600	1610	1700	1701	1702	1703	1704	1705	1706	1707
Continuous Stall Current	A rms	<b>DMTIC</b>	2.48	2.38	2.48	2.48	2.48	2.48	2.38	2.38	2.38	2.38
Flux constant - Ke	V / m/s (V / krpm)	<b>DMTKE</b>	25.25 (17.6)	37.7 (26.4)	25.25 (17.6)	25.25 (17.6)	25.25 (17.6)	25.25 (17.6)	37.7 (26.4)	37.7 (26.4)	37.7 (26.4)	37.7 (26.4)
Resistance (ph-ph)	Ohms	<b>DMTRES</b>	10.1	15.3	10.1	10.1	10.1	10.1	15.3	15.3	15.3	15.3
Motor Mass	kg (kg m <sup>2</sup> E-6)	<b>DMTJ</b>	.6 (26.8)	.8 (37.5)	2.7 (119.3)	2.7 (119.3)	2.7 (119.3)	2.7 (119.3)	3.6 (159.1)	3.6 (159.1)	3.6 (159.1)	3.6 (159.1)
Pole Pairs	-	<b>DPOLE</b>	1	1	1	1	1	1	1	1	1	1
Rated Speed	m/s (rps)	<b>DMTW</b>	3 (72)	3 (72)	3 (72)	1.5 (35.7)	.3 (7.2)	3 (72)	.3 (7.2)	1.5 (35.7)	.3 (7.2)	3 (72)
Current Peak Stall	A rms	<b>DMTIP</b>	7.4	7.1	7.4	7.4	7.4	7.4	7.1	7.1	7.1	7.1
Minimum Inductance (ph-ph)	mH	<b>DMTLMN</b>	2.9	4.5	2.9	2.9	2.9	2.9	4.5	4.5	4.5	4.5
Maximum Inductance (ph-ph)	mH	<b>DMTLMX</b>	2.9	4.5	2.9	2.9	2.9	2.9	4.5	4.5	4.5	4.5
Continuous current derating	%	<b>DMTICD</b>	0	0	0	0	0	0	0	0	0	0
Thermal Time Constant	minutes	<b>DMTTCM</b>	20	30	20	20	20	20	30	30	30	30
Viscous Damping	N/m (Nm/rad/sec)	<b>DMTD</b>	0	0	0	0	0	0	0	0	0	0
Current Loop Bandwidth	Hz	<b>DIBW</b>	1500	1500	1500	1500	1500	1500	1500	1500	1500	1500
Velocity Loop Bandwidth	Hz	<b>DVBW</b>	100	100	100	100	100	100	100	100	100	100
Position Loop Bandwidth	Hz	<b>DPBW</b>	40	40	40	40	40	40	40	40	40	40
Force/Torque Limit	N (Nm)	<b>DMTLIM</b>	227 (1.5)	329 (2.2)	227 (1.5)	227 (1.5)	227 (1.5)	227 (1.5)	329 (2.2)	329 (2.2)	329 (2.2)	329 (2.2)
Force / Torque Scale	N (Nm)	<b>DMTSCS</b>	227 (1.5)	329 (2.2)	227 (1.5)	227 (1.5)	227 (1.5)	227 (1.5)	329 (2.2)	329 (2.2)	329 (2.2)	329 (2.2)
Velocity Limit	m/s (rps)	<b>DMVLIM</b>	3 (72)	3 (72)	3 (72)	1.5 (35.7)	.3 (7.2)	3 (72)	3 (72)	1.5 (35.7)	.3 (7.2)	3 (72)
Velocity Scale	m/s (rps)	<b>DMVSCL</b>	3 (72)	3 (72)	3 (72)	1.5 (35.7)	.3 (7.2)	3 (72)	3 (72)	1.5 (35.7)	.3 (7.2)	3 (72)
Feedback Resolution	counts / Elec. Pitch (counts/rev)	<b>ERES</b>	0	0	42000	84000	420000	8400	42000	84000	420000	8400
Encoder Out Resolution	counts / Elec. Pitch (counts/rev)	<b>ORES</b>	0	0	42000	84000	420000	8400	42000	84000	420000	8400
Winding Time Constant	minutes	<b>DMTTCW</b>	0.33	0.33	0.33	0.33	0.33	0.33	0.33	0.33	0.33	0.33
Thermal Resistance (w-c)	deg. C/W	<b>DMTRWC</b>	0.23	0.17	0.23	0.23	0.23	0.23	0.17	0.17	0.17	0.17
Electrical Pitch	mm	<b>DMEPIT</b>	42	42	42	42	42	42	42	42	42	42
Max. Motor Temperature	deg. C	<b>DMTMAX</b>	90	90	90	90	90	90	90	90	90	90
Drive PWM frequency	Hz	<b>DPWM</b>	16	16	16	16	16	16	16	16	16	16
Maximum Position Error	counts	<b>SMPER</b>	0	0	42000	84000	420000	8400	42000	84000	420000	8400

## Recommended Drive/Linear Servo Motor Table Systems

---

We recommend you use the following linear servo motor tables with drives listed in the *Recommended Drive Type* column.

<b>Linear Servo Motor Table:</b>	<b>Recommended Drive Type:</b>
406LXR-D13	GV-L3E or GV-U6E*
<u>406LXR-D15</u>	<u>GV-L3E or GV-U6E*</u>

\*(GV-U6E at 16 kHz PWM only; see DPWM command in *Gemini Series Command Reference*)

# Part Numbering System – 406LXR Example

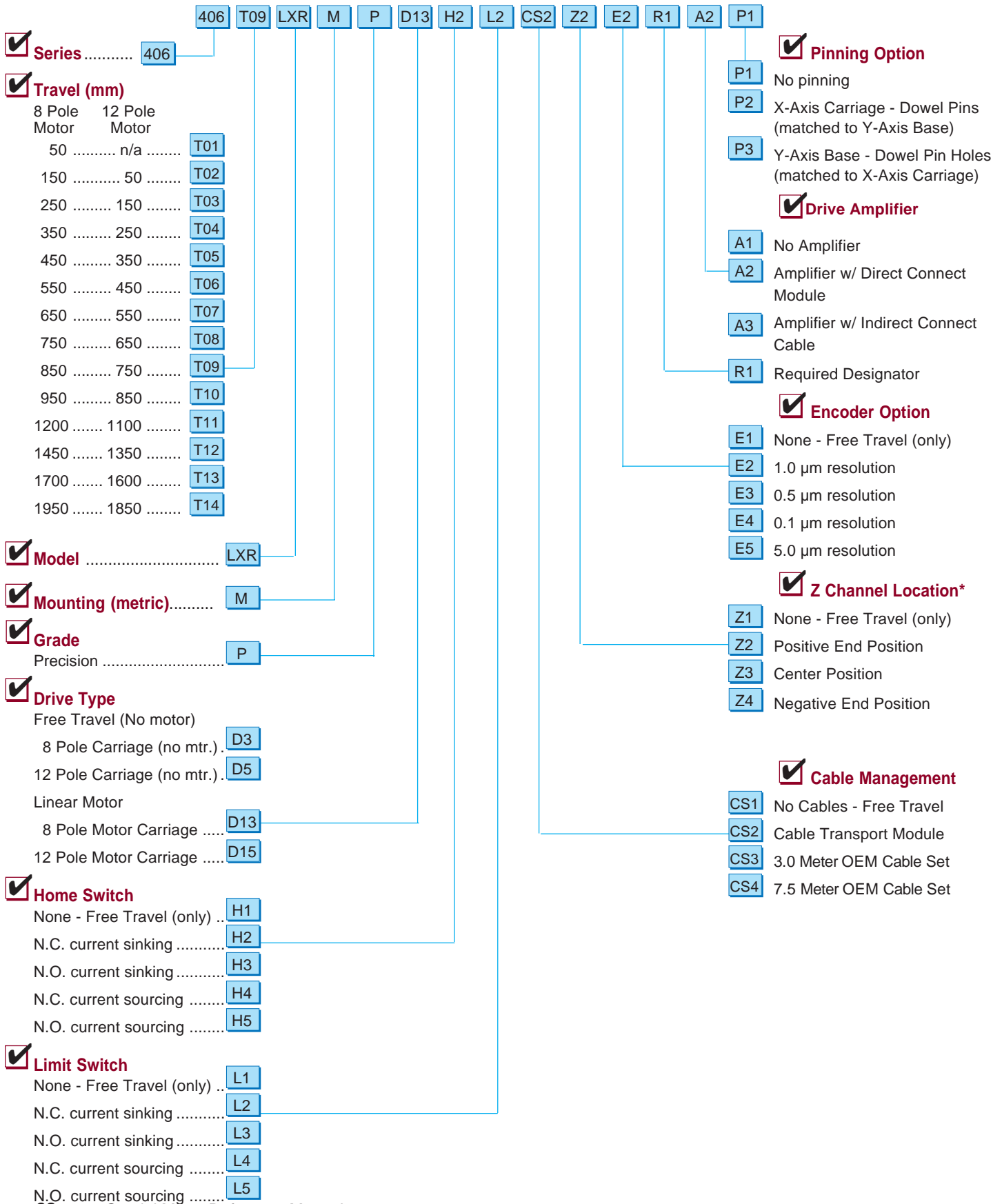

# Speed/Force Curves

## 406LXR with GV-L3E

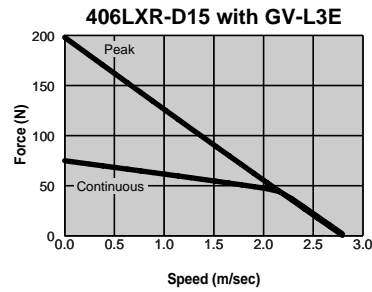
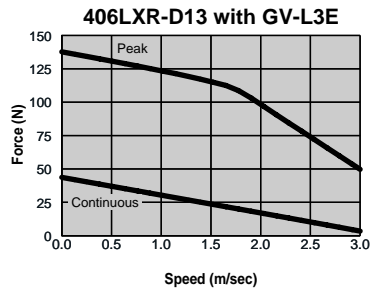

**NOTES:**

- Solid lines designate 120VAC operation, continuous and peak.
- Curves represent 120VAC (nominal) operation.
- Maximum speed limited by encoder resolution (see *Table Specifications*).
- Actual speed/force curves may vary  $\pm 10\%$ .

## 406LXR with GV-U6E

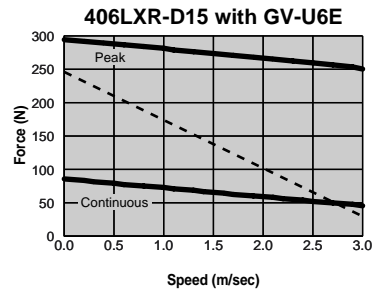
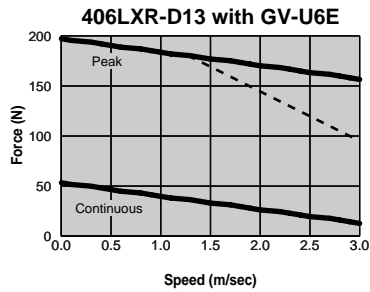

**NOTES:**

- Solid lines designate 240VAC operation, continuous and peak.
- Dashed line designates 120VAC speed limit.
- Curves represent 120VAC (nominal) and 240VAC (nominal) operation.
- Maximum speed limited by encoder resolution (see *Table Specifications*).
- Actual speed/force curves may vary  $\pm 10\%$ .

# Motor Specifications

Data listed is for motor only. Drive specifications may change some values.

## SL Series Linear Servo Motors, Encoder Feedback

Parameter:	Symbol:	Units:	406LXR-D13	406LXR-D15
Daedal 406LXR Motor Number	Drive Type		D13	D15
Stall Force Continuous [1]	Fcs	N	75	110
		lbf	17.0	25.0
Stall Current Continuous [1, 4, 8]	Ics(sine)	Amps Peak	3.5	3.4
Stall Current Continuous [1, 7]	Ics(trap)	Amps DC	3.0	2.9
Peak Force [6]	Fpk	N	225	330
		lbf	50.0	74.0
Peak Current [4, 6, 8]	Ipk(sine)	Amps Peak	10.4	10.1
Peak Current [6, 7]	Ipk(trap)	Amps DC	9.0	8.7
Rated Speed [2]	Vr	m/s	1.7	3.2
		in/s	67	126
Maximum Speed [13]	Vmax	m/s	5	5
		in/s	197	197
Current @ Rated Speed	Ir(sine)	Amps	3.5	3.4
Current @ Rated Speed	Ir(trap)	Amps	3.0	2.9
Force @ Rated Speed	Fr	N	23.3	43.4
		lbf	5.2	9.8
Output Power @ Rated Speed	Po	watts	39.61	138.88
Voltage Constant [3, 4]	Kb	Volts/m/s	25.15	37.70
		Volts/in/s	0.64	0.96
Force Constant [9]	Kf(sine)	N/Amp Peak	21.78	32.64
		lbf/Amp Peak	4.9	7.3
Force Constant [3, 4]	Kf(trap)	N/Amp DC	25.15	37.70
		lbf/Amp Peak	5.7	8.5
Resistance [3]	R	Ohms	10.2	15.3
Inductance [5]	L	mH	2.63	4.49
Maximum Bus Voltage	Vm	Volts DC	340	340
Thermal Resistance Wind-Amb	Rth w-a	C/watt	0.56	0.40
Thermal Resistance Wind-Case	Rth w-c	C/watt	0.23	0.17
Motor Constant	Km	N/sqrt(watt)	7.9	9.6
		lbf/sqrt(watt)	1.8	2.2
Viscous Damping	B	N/m/s	13.30	13.30
		lbf/in/s	0.076	0.076
Static Friction	Ff	N	18.7	18.7
		lbf	4.2	4.2
Motor Thermal Time Constant	Tau_th	minutes	20	30
Winding Thermal Time Const	Tau_wnd	minutes	0.33	0.33
Electrical Time Constant	Tau_elec	millisecs	0.258	0.294
Maximum Theoretical Acceleration [14]	Amax	g	8.66	9.43
Intermittent Force Duration [10]	F_2x	seconds	7.0	7.0
Peak Force Duration [11]	F_3x	seconds	3	3
Magnetic Attraction [2]	Fn	N	280	420
		lbf	62.9	94.4
Electrical Pitch [12]	Epitch	mm	42	42
		in	1.64	1.64
Mass of Motor and Carriage	Mcar	Kg	3.2	4.6
		lb	7.0	10.1
Rated Winding Temp	RT	C	90	90
Rated Ambient Temp	AT	C	25	25
Winding Class			H	H

- 1 @ 25C ambient, 90C winding temperature
- 2 Measured with a 0.76 mm gap
- 3 Measured Line to Line, +/- 10%.
- 4 Value is measured peak of sine wave.
- 5 +/-30%, Line-to-Line, inductance bridge measurement @1Khz.
- 6 Initial winding temperature must be 60 C or less before peak current is applied.
- 7 DC current through a pair of motor phases of a trapaziodally (six state) commutated motor.
- 8 Peak of the sinusiodal current in any phase for a sinusiodally commutated motor.
- 9 Total motor torque per peak of the sinusiodal amps measured in any phase, +/-10%.
- 10 Maximum time duration with 2 times rated current applied with initial winding temp at 60 C.
- 11 Maximum time duration with 3 times rated current applied with initial winding temp at 60 C.
- 12 The distance from the leading edge of a north pole to the leading edge of the next north pole.
- 13 Maximum speed limited by encoder resolution (see *Table Specifications*).
- 14 Actual acceleration is load and duty cycle dependant.

## Table Specifications

### 406LXR Series

Travel (mm)	8 pole motor	50	150	250	350	450	550	650	750	850	950	1200	1450	1700	1950
	12 pole motor	N/A	50	150	250	350	450	550	650	750	850	1100	1350	1600	1850
Encoder Resolution (selectable)		0.1, 0.5, 1.0, 5.0 $\mu\text{m}$													
Repeatability	0.1 $\mu\text{m}$ resolution	+/- 1.0 $\mu\text{m}$													
	0.5 $\mu\text{m}$ resolution	+/- 1.0 $\mu\text{m}$													
	1.0 $\mu\text{m}$ resolution	+/- 2.0 $\mu\text{m}$													
	5.0 $\mu\text{m}$ resolution	+/- 10.0 $\mu\text{m}$													
Velocity (maximum)	0.1 $\mu\text{m}$ resolution	0.3 m/sec.													
	0.5 $\mu\text{m}$ resolution	1.5 m/sec.													
	1.0 $\mu\text{m}$ resolution	3.0 m/sec.													
	5.0 $\mu\text{m}$ resolution	3.0 m/sec.													
Acceleration (maximum)		5 g's													
Load - Normal (maximum)		180 Kgf @ (2540 kilometers-life)													
Accuracy - Positional ( $\mu\text{m}$ )		12	12	12	16	24	24	28	36	36	40	48	60	72	84
Accuracy - Straightline ( $\mu\text{m}$ )		11	16	19	25	32	35	40	45	50	55	75	95	115	135
Unit Weight (Kg)	8 pole motor	8.7	10.3	12.6	13.3	14.8	16.4	17.9	19.4	20.9	22.5	26.3	30.1	33.9	37.7
	12 pole motor	N/A	11.1	13.4	14.1	15.7	17.2	18.7	20.2	21.8	23.3	27.1	30.9	34.7	38.6
Carriage Weight	8 pole motor	3.2 Kg													
	12 pole motor	4.1 Kg													
Maximum Force (Peak)	8 pole motor	225 N													
	12 pole motor	330 N													
Maximum Force (Continuous)	8 pole motor	75 N													
	12 pole motor	110 N													
Linear Bearing - Coefficient of Friction		0.01													

# Dimensions

## 406LXR Series

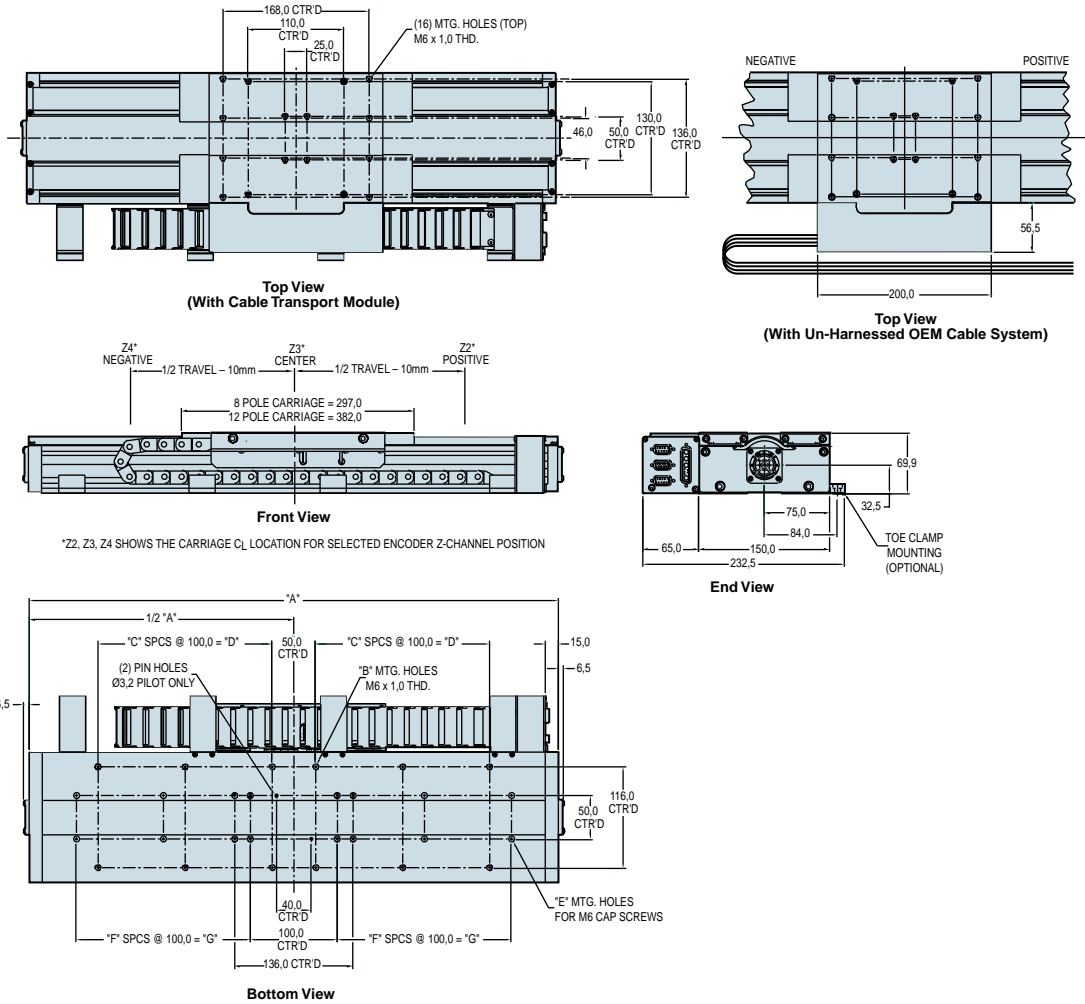

Model	Travel 8 Pole	Travel 12 Pole	A	B	C	D	E	F	G
406T01	50	N/A	408	8	1	100.0	12	1	100.0
406T02	150	50	508	8	1	100.0	12	1	100.0
406T03	250	150	608	12	2	200.0	16	2	200.0
406T04	350	250	708	12	2	200.0	16	2	200.0
406T05	450	350	808	16	3	300.0	20	3	300.0
406T06	550	450	908	16	3	300.0	20	3	300.0
406T07	650	550	1008	20	4	400.0	24	4	400.0
406T08	750	650	1108	20	4	400.0	24	4	400.0
406T09	850	750	1208	24	5	500.0	28	5	500.0
406T10	950	850	1308	24	5	500.0	28	5	500.0
406T11	1200	1100	1558	32	7	700.0	32	6	600.0
406T12	1450	1350	1808	36	8	800.0	40	8	800.0
406T13	1700	1600	2058	40	9	900.0	44	9	900.0
406T14	1950	1850	2308	44	10	1000.0	48	10	1000.0



# Wiring Information

## Cable Transport Module

The 406LXR's Cable Transport Module (CS2 option) offers convenient connectivity for fast table installation and "quick change" replacement. This cable management system includes high-flex ribbon cable (life rating of 20 million cycles), a cable track with support brackets, a "quick change" carriage cartridge, and a panel for plug-in connectors.

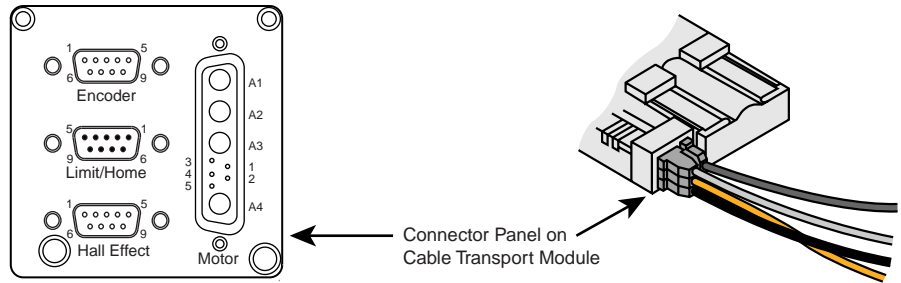

Connector Panel

## Cables and Adapters

A cable or adapter is required for easy hook-up between the Gemini drive and the 406LXR and is included with the A2 or A3 option. The A2 version includes a plug-in module for direct connection, and the A3 version includes an adapter cable for indirect connection to an electrical panel strip.

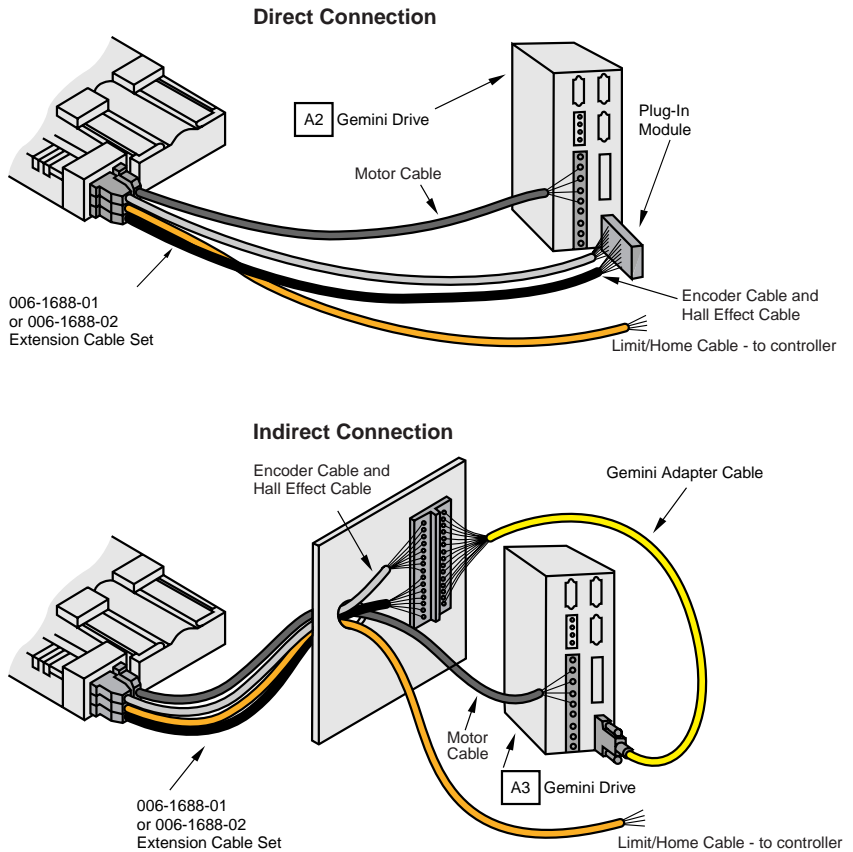

Direct and Indirect Connections

## High-Flex Extension Cables

These cables provide extensions from the Connector Panel on the Cable Transport Module, to the Gemini drive, and to the controller. Each cable is offered separately or as a complete set. They are offered in two lengths—3 meters or 7.5 meters. These cables are high-flex, longlife cables so they can be utilized on a second or third axis unit. The following table gives the Daedal part numbers:

Flying Lead Cables & Daedal part numbers		
Cable Type:	3 meters:	7.5 meters
Motor	006-1684-01	006-1684-02
Encoder	006-1686-01	006-1686-02
Limit/Home	006-1687-01	006-1687-02
Hall Effect	006-1685-01	006-1685-02
<b>Complete Cable Set</b>	<b>006-1688-01</b>	<b>006-1688-02</b>

## Connector Panel and Cable Pinout Diagrams

The following tables show the pinouts for the connector panel and the High-Flex Extension Cables, and color codes for the cables.

### Motor Connections

Function	Cable Wire Color	Gemini Connections	406LXR Connector Male Power D-Connector	Mating Connector Female Power D-Connector
Phase A	Red	U	A1	A1
Phase B	White	V	A2	A2
Phase C	Black	W	A3	A3
Ground	Green	↓	A4	A4
N/A	N/C	N/C	1	1
N/A	N/C	N/C	2	2
N/A	N/C	N/C	3	3
N/A	N/C	N/C	4	4
N/A	N/C	N/C	5	5
Shield	Green/Yellow	↓	Shield Cover	Shield Cover

### Fan Connector (OEM cabling only)

Function	Pin #
+24VDC	1
Ground	2

### Encoder Connections

Function	Cable Wire Color	406LXR Connector Male 9 Pin D-Connector	Mating Connector Female 9 Pin D-Connector
+5VDC	Red	1	1
Ch A+	White	2	2
Ch A-	Yellow	3	3
Ch B+	Green	4	4
Ch B-	Blue	5	5
Ch Z+	Orange	6	6
Ch Z-	Brown	7	7
N/A	Key Plug	8	8
Ground	Black	9	9
Shield	Green/Yellow	Shield Cover	Shield Cover

### Limit and Home Connections

Function	Cable Wire Color	406LXR Connector Female 9 Pin D-Connector	Mating Connector Male 9 Pin D-Connector
+5 to +24VDC	Red	1	1
Negative Limit	Blue	2	2
Positive Limit	Orange	3	3
Home	Green	4	4
+24VDC Fan	Brown	5 *	5
N/A	Key Plug	6	6
Fan Ground	White	7 *	7
Spare	Yellow	8	8
Ground	Black	9	9
Shield	Green/Yellow	Shield Cover	Shield Cover

\*Transport module only

### Hall Effect Connections

Function	Cable Wire Color	406LXR Connector Male 9 Pin D-Connector	Mating Connector Female 9 Pin D-Connector
+5VDC	White/Blue	1	1
Hall 1	White/Brown	2	2
Hall 2	White/Orange	3	3
Hall 3	White/Violet	4	4
N/A	Key Plug	5	5
Temp	Yellow	6	6
Temp	Yellow	7	7
Spare	Red	8	8
Ground	White/Green	9	9
Shield	Green/Yellow	Shield Cover	Shield Cover

## Cable Pinout Diagrams

### Gemini Adapter Cable

Use this cable to connect the encoder and Hall effect signals from an electrical panel strip to the Gemini's 26 pin MOTOR FEEDBACK connector.

Function	Wire Color	Amp Champ
<b>Encoder Wires</b>		
Ch A+	White	5
Ch A-	Yellow	6
Ch B+	Green	7
Ch B-	Blue	8
Index+	Orange	9
Index-	Brown	10
Ground	Black	3, 4
+5VDC	Red	1, 2
<b>Hall Signal Wires</b>		
Hall Gnd	White/Green	15
Hall +5V	White/Blue	14
Hall 1	White/Brown	16
Hall 2	White/Orange	17
Hall 3	White/Violet	18
<b>Temperature Switch</b>		
Temp Switch	Yellow/Orange	12
Temp Switch	Yellow/Orange	13
Shield	Bare	Case

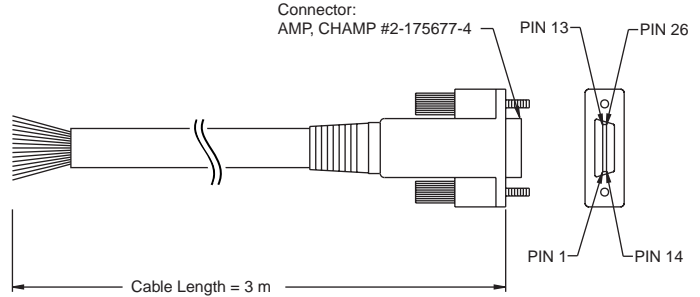

Daedal Part Number for Gemini Adapter Cable: 006-1683-01

### Gemini Adapter Cable

### Gemini Plug-in Connection Module

Use this module to directly connect the 406LXR's encoder and Hall effect cables to the Gemini drive. Make sure you connect your wires before you plug the module into the Gemini drive.

Function	Wire Color	Module
<b>Encoder Wires</b>		
Ch A+	White	5
Ch A-	Yellow	6
Ch B+	Green	7
Ch B-	Blue	8
Index+	Orange	9
Index-	Brown	10
Ground	Black	3, 4
+5VDC	Red	1, 2
Shield	Green/Yellow	S
<b>Hall Signal Wires</b>		
Hall Gnd	White/Green	15
Hall +5V	White/Blue	14
Hall 1	White/Brown	16
Hall 2	White/Orange	17
Hall 3	White/Violet	18
Shield	Green/Yellow	S
<b>Temperature Switch</b>		
Temp Switch	Yellow	12
Temp Switch	Yellow	13

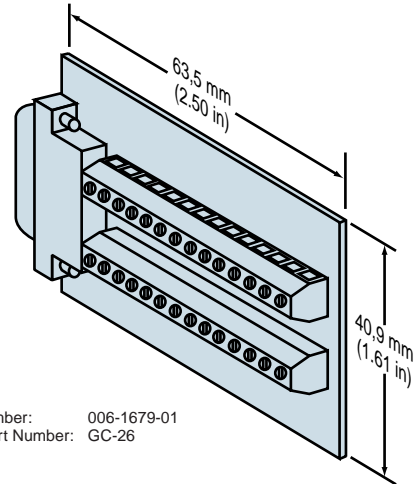

Daedal Part Number: 006-1679-01  
Compumotor Part Number: GC-26

### Plug-in Connection Module

### Unharnessed OEM Cable System

The 406LXR's unharnessed cable system is offered for OEMs and other customers who have independent methods of routing and managing cables. The cables are round high-flex cables with a nominal rated life of 10 million cycles (depending on cable bend radius). They are available in lengths of 3.0 or 7.5 meters and with flying lead end terminations.

Cable Option:	Description:
CS3	3.0 meter OEM cable set
CS4	7.5 meter OEM cable set

# Feedback Specifications

## Encoder Specifications

Description	Specification
Input Power	5VDC $\pm$ 5%, 150mA
Output (incremental)	Square wave differential line driver (EIA RS422) 2 channels A and B in quadrature (90) phase shift
Reference (Z channel)	Synchronized pulse, duration equal to one resolution bit. Repeatability of position is unidirectional moving toward positive direction, and equal to repeatability listed in <i>Table Specifications</i> .
Maximum Speed	5.0 micron resolution = 3.0 meters/sec 1.0 micron resolution = 3.0 meters/sec 0.5 micron resolution = 1.5 meters/sec 0.1 micron resolution = 0.3 meters/sec

## Limit and Home Sensor Specifications

Description	Specification
Input Power	+5VDC to +24VDC; 60mA (20mA per sensor)
Output	Output form is selectable with product: Normally Closed current sinking Normally Open current sinking Normally Closed current sourcing Normally Open current sourcing All types sink or source maximum of 100mA
Repeatability	Limits: $\pm$ 10 microns (unidirectional) Home: See Z channel specifications

## Hall Effect Specifications

Description	Specification
Input Power	+5VDC to +24VDC, 30mA
Output	Open collector, current sinking, 20mA maximum

## Commutation Chart

Pattern established with the carriage moving in Positive Direction  
(for direction reference, see dimension drawing—front view)

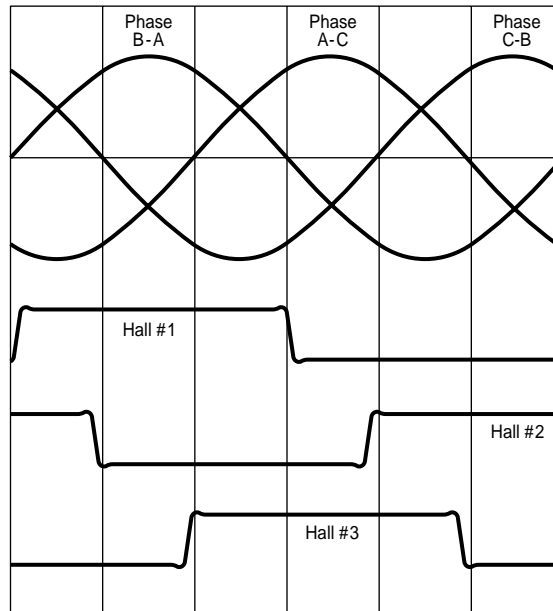

## Bearing Load and Life Information

The useful life of a linear table at full catalog specifications is dependent on the forces acting upon it. These forces include both static components resulting from payload weight, and dynamic components due to acceleration/deceleration of the load. In multi-axis applications, the primary positioner at the bottom of the stack usually establishes the load limits for the combined axes. When determining load/life, it is critical to include the weight of all positioning elements that contribute to the load supported by the primary axis. The load/life charts are used to establish the table life relative to the applied loads.

### Table Load Chart

The *Table Load Chart* below is intended to provide a rough-cut evaluation of “life/load” characteristics for the carriage support bearings. This curve is based on the applied load being centered on the carriage, normal to the carriage mounting surface.

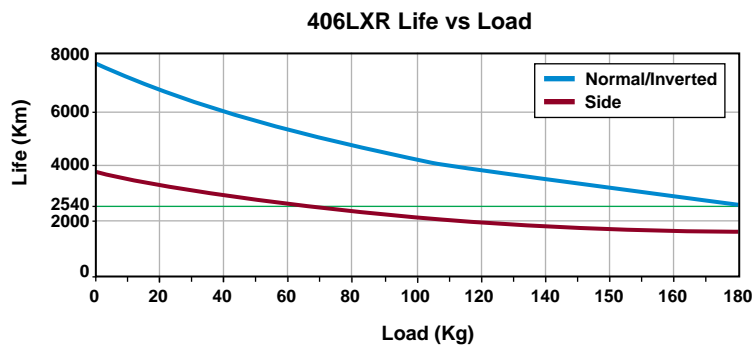

### Bearing Load Chart

Several dimensions and the load geometry are required for calculating life/load information for each bearing (4 per table). The dimensions, detailed instructions, and examples are provided in the *Engineering Reference* section of Daedal’s *Catalog 9143/USA*. The *Bearing Load Chart* below is used in the final step of the calculations, to establish the load/life for each bearing.

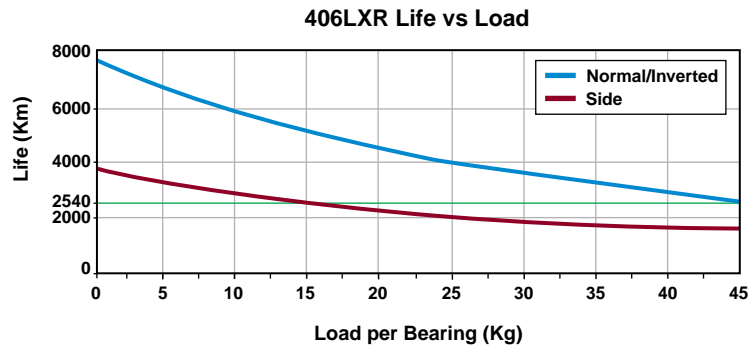



CHAPTER FOUR

# 4 Step Motors

## Recommended Drive/Motor Systems

We recommend you use the following motors with drives listed in the *Recommended Drive Type* column.

Motor Model Number	Drive Type Recommended	Motor Model Number	Drive Type Recommended
OS2HA-xxFLY (series)	GT-U5	RS42B-xxS10 (series)	GT-L8
OS21A-xxFLY (series)	GT-U5	RE42B-xxS10 (series)	GT-L8
OS22A-xxFLY (series)	GT-U5		
		RS42B-xxP10 (parallel)	GT-L8
OS2HA-xxL10 (series)	GT-U5	RE42B-xxP10 (parallel)	GT-L8
OS21A-xxL10 (series)	GT-U5		
OS22A-xxL10 (series)	GT-U5	TS31B-xxS10 (series)	GT-L5
		TS32B-xxS10 (series)	GT-L8
OS2HA-xxFLY (parallel)	GT-U8	TS33B-xxS10 (series)	GT-L8
OS21A-xxFLY (parallel)	GT-U8		
OS22A-xxFLY (parallel)	GT-U8	TS31B-xxP10 (parallel)	GT-L8
		TS32B-xxP10 (parallel)	GT-L8
OS2HA-xxL10 (parallel)	GT-U8	TS33B-xxP10 (parallel)	GT-L8
OS21A-xxL10 (parallel)	GT-U8		
OS22A-xxL10 (parallel)	GT-U8	TS41B-xxS10 (series)	GT-L8
		TS42B-xxS10 (series)	GT-L8
OS2HB-xxFLY (series)	GT-L5	TS43B-xxS10 (series)	GT-L8
OS21B-xxFLY (series)	GT-L5		
OS22B-xxFLY (series)	GT-L5	TS41B-xxP10 (parallel)	GT-L8
		TS42B-xxP10 (parallel)	GT-L8
OS2HB-xxL10 (series)	GT-L5	TS43B-xxP10 (parallel)	GT-L8
OS21B-xxL10 (series)	GT-L5		
OS22B-xxL10 (series)	GT-L5	ES21B-xxR10 (series)	GT-L5
		ES22B-xxR10 (series)	GT-L5
OS2HB-xxFLY (parallel)	GT-L5	ES23B-xxR10 (series)	GT-L5
OS21B-xxFLY (parallel)	GT-L5		
OS22B-xxFLY (parallel)	GT-L5	ES21B-xxR10 (parallel)	GT-L5
		ES22B-xxR10 (parallel)	GT-L5
OS2HB-xxL10 (parallel)	GT-L5	ES23B-xxR10 (parallel)	GT-L5
OS21B-xxL10 (parallel)	GT-L5		
OS22B-xxL10 (parallel)	GT-L5	ES31B-xxR10 (series)	GT-L5
		ES32B-xxR10 (series)	GT-L5
RS31B-xxS10 (series)	GT-L5	ES33B-xxR10 (series)	GT-L5
RS32B-xxS10 (series)	GT-L8		
RS33B-xxS10 (series)	GT-L8	ES31B-xxR10 (parallel)	GT-L5
		ES32B-xxR10 (parallel)	GT-L8
RS31B-xxP10 (parallel)	GT-L8	ES33B-xxR10 (parallel)	GT-L8
RS32B-xxP10 (parallel)	GT-L8		
RS33B-xxP10 (parallel)	GT-L8		

Equivalent to:

(ZETA57-51S)

(ZETA57-83S)

(ZETA57-102S)

(ZETA57-51P)

(ZETA57-83P)

(ZETA57-102P)

(ZETA83-62S)

(ZETA83-93S)

(ZETA83-135S)

(ZETA83-62P)

(ZETA83-93P)

(ZETA83-135P)



# Speed/Torque Curves

## O Series Motors, "A" Windings

### Size 23 Frame

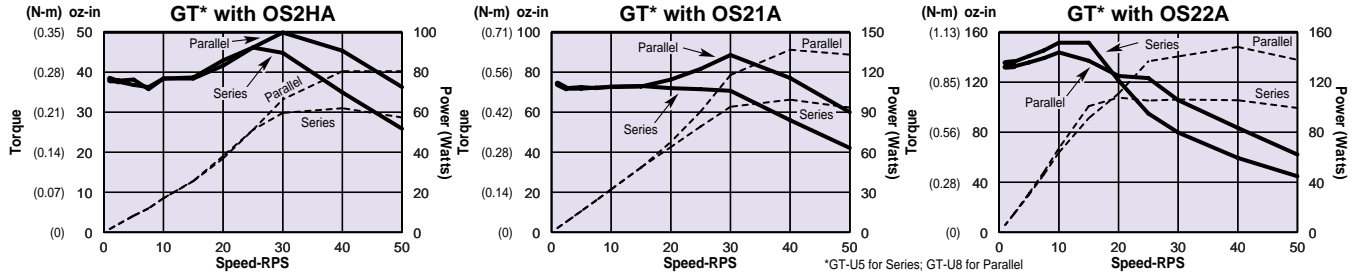

## O Series Motors, "B" Windings

### Size 23 Frame

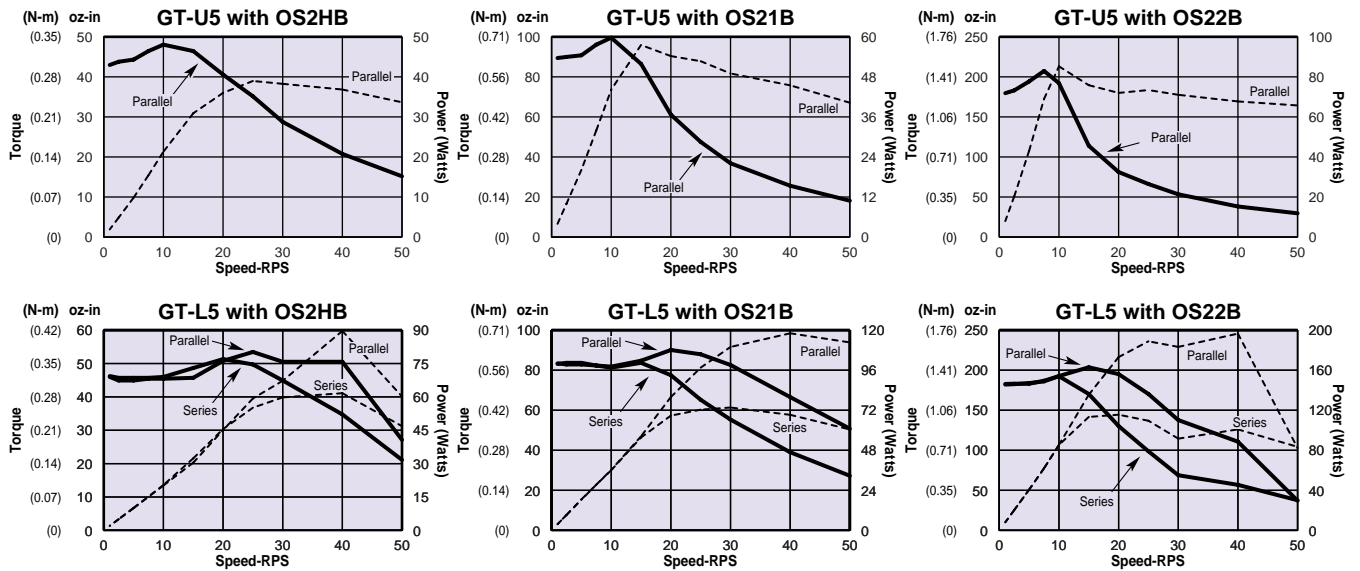

**R Series Motors,  
Size 34 Frame**

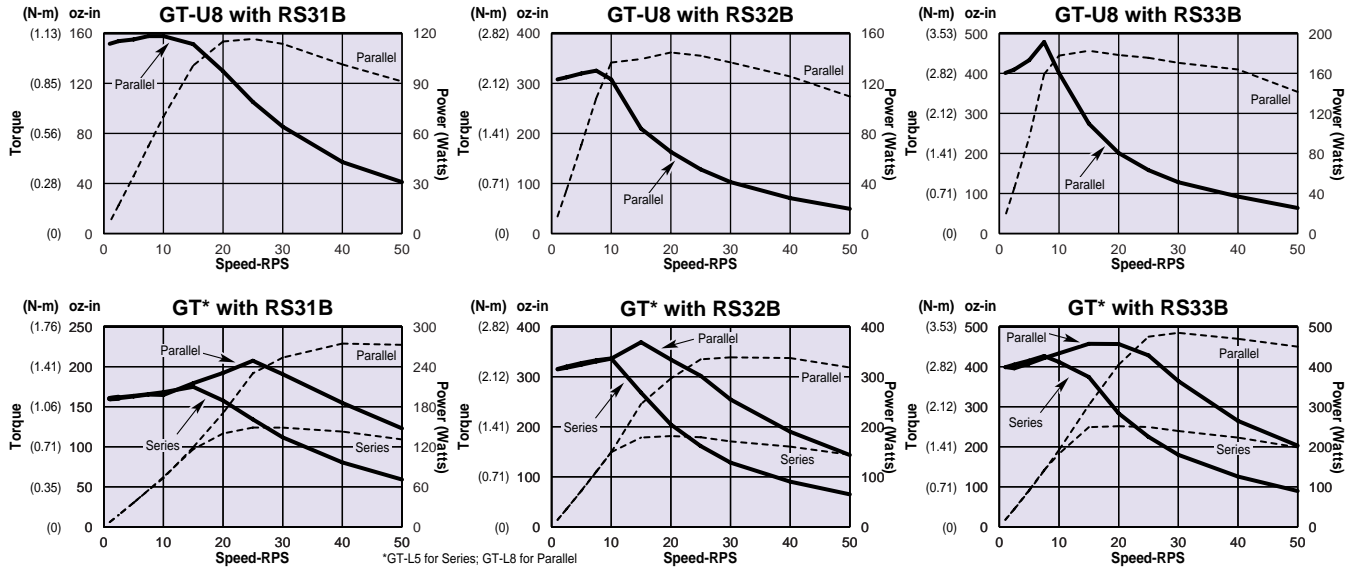

**R Series Motors,  
Size 42 Frame**

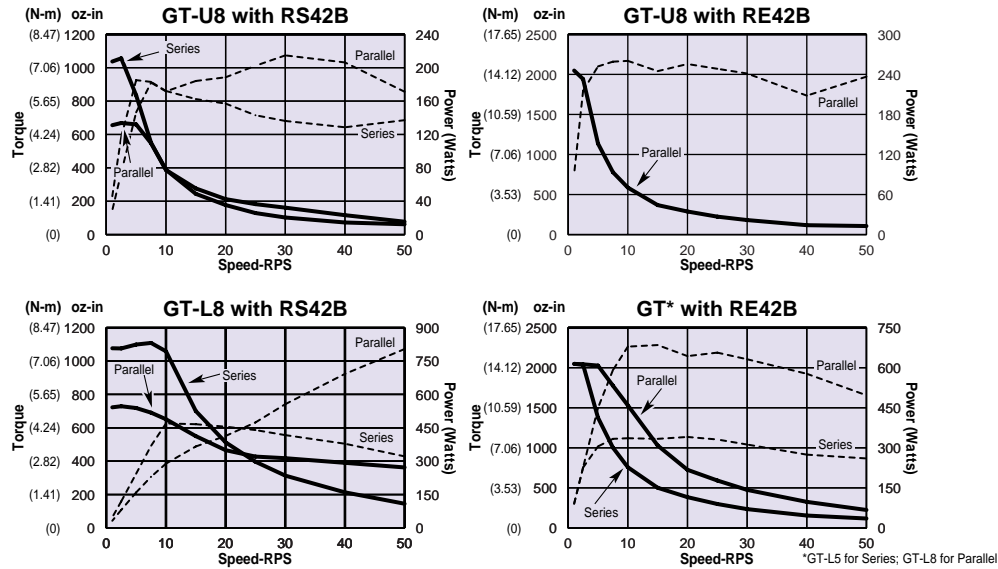

**T Series Motors,  
Size 34 Frame**

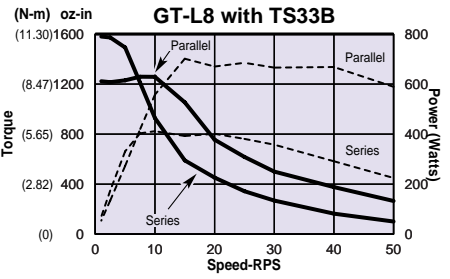
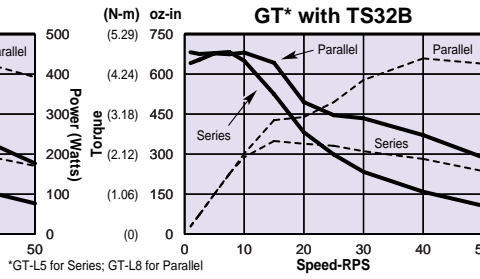
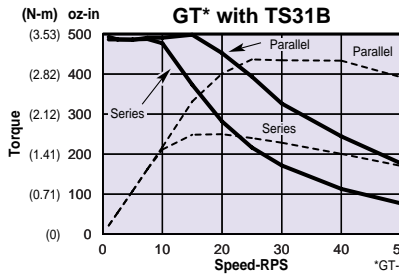

\*GT-L5 for Series; GT-L8 for Parallel

**T Series Motors,  
Size 42 Frame**

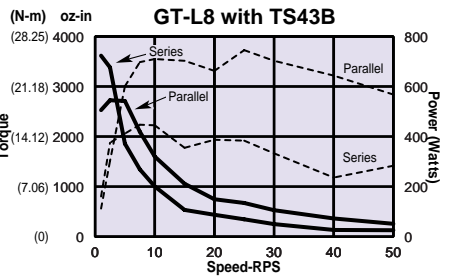
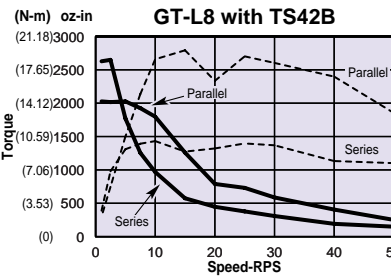
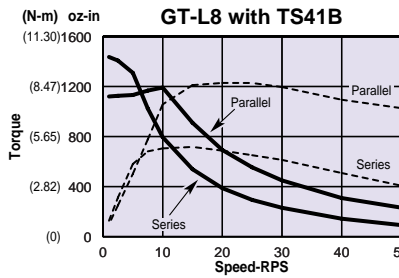

**E Series Motors,  
Size 23 Frame**

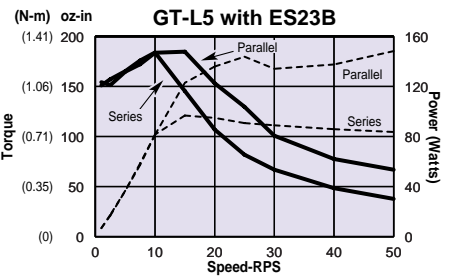
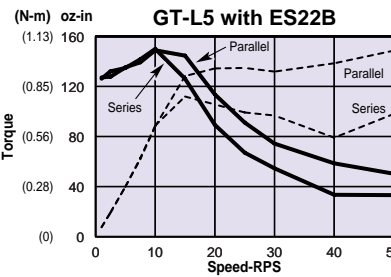
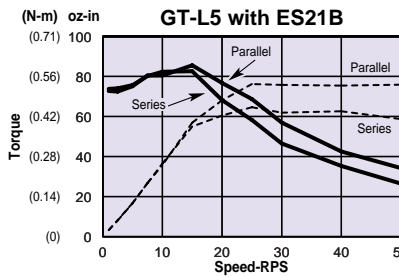
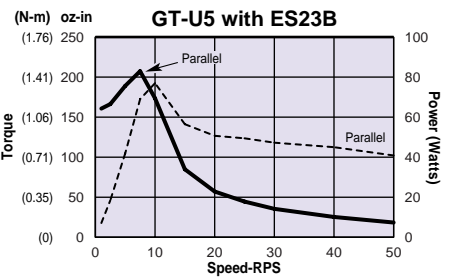
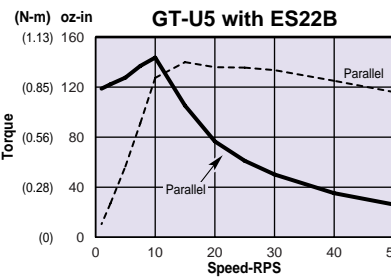
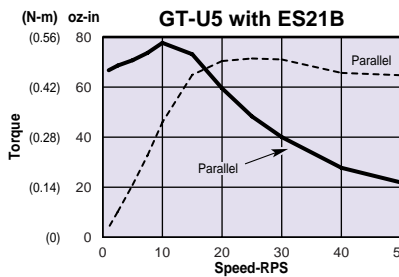

**E Series Motors,  
Size 34 Frame**

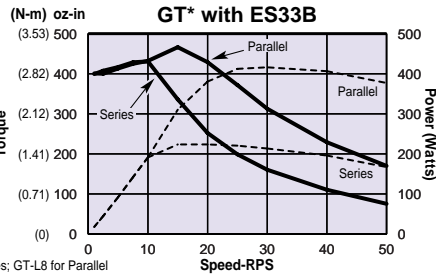
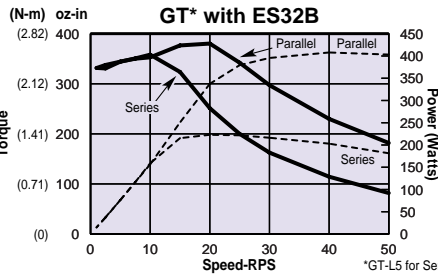
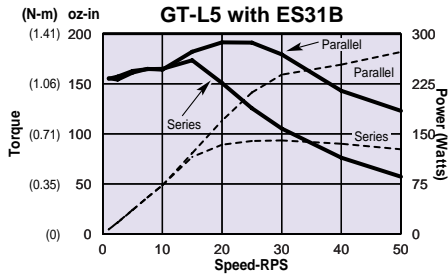
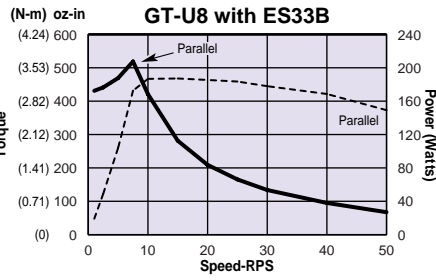
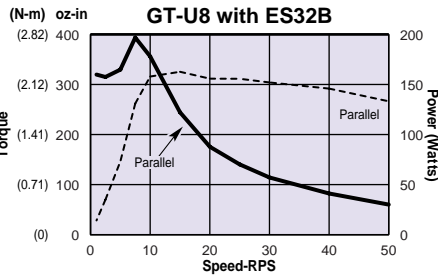
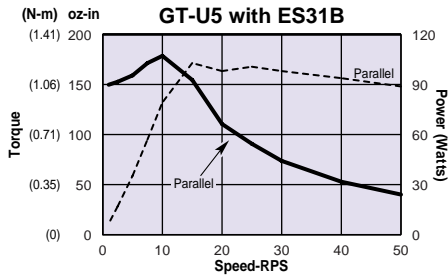

\*GT-L5 for Series; GT-L8 for Parallel

# Specifications

## O Series Motors with “A” Windings (75VDC Motors)

	Size 23 Frame		
	OS2HA	OS21A	OS22A
<b>Static torque</b>			
oz-in (Nm)	37 (0.26)	66 (0.47)	133 (0.94)
<b>Rotor inertia</b>			
oz-in <sup>2</sup> (kg-cm <sup>2</sup> )	0.386 (0.070)	0.656 (0.119)	1.390 (0.253)
<b>Drive Current (Apk)(Arms)</b>			
Series	2.65 (1.9)	3.3 (2.3)	3.8 (2.7)
Parallel	5.3 (3.7)	6.6 (4.7)	7.5 (5.3)
<b>Phase Inductance (mH)</b>			
Series	1.7	1.8	2.8
Parallel	0.4	0.4	0.7
<b>Detent Torque</b>			
oz-in (Nm)	2.5 (0.018)	4.0 (0.028)	7.0 (0.049)
<b>Bearings Information</b>			
<b>Thrust Load</b>			
lb (kg)	13 (5.9)	13 (5.9)	13 (5.9)
<b>Radial Load</b>			
lb (kg)	20 (9.1)	20 (9.1)	20 (9.1)
<b>End Play (Reversing load equal to 1 lb)</b>			
in (mm)	0.001 (0.025)	0.001 (0.025)	0.001 (0.025)
<b>Radial Play (Per 0.5 lb load)</b>			
in (mm)	0.0008 (0.02)	0.0008 (0.02)	0.0008 (0.02)
<b>Motor Weight</b>			
lb (kg)	1 (0.45)	1.5 (0.68)	2.5 (1.14)
<b>Certifications</b>			
UL recognized	Pending	Pending	Pending
CE (LVD)	Yes	Yes	Yes
CE (EMC & LVD)	No	No	No

**O Series Motors with “B” Windings (170VDC Motors)  
R Series Motors**

Parameters	Size 23 Frame			Size 34 Frame			Size 42 Frame	
	OS2HB	OS21B	OS22B	RS31B	RS32B	RS33B	RS42B	RE42B
<b>Static torque**</b>								
oz-in (Nm)	43 (0.30)	82 (0.58)	155 (1.09)	133 (0.93)	267 (1.87)	392 (2.74)	985 (6.90)	1907 (13.35)
<b>Rotor inertia</b>								
oz-in <sup>2</sup> (kg-cm <sup>2</sup> )	0.39 (0.07)	0.66 (0.12)	1.39 (0.25)	3.02 (0.55)	6.56 (1.20)	9.65 (1.77)	61.76 (11.30)	61.76 (11.30)
<b>Drive Current (Apk)(Arms)**</b>								
Series	1.5 (1.0)	1.8 (1.3)	2.2 (1.5)	2.3 (1.6)	2.8 (2.0)	3.4 (2.4)	6.1 (4.3)	3.4 (2.4)
Parallel	3.0 (2.1)	4.0 (2.8)	4.0 (2.8)	4.6 (3.3)	5.6 (4.0)	6.9 (4.9)	12.0 (8.5)	7.2 (5.1)
<b>Phase Inductance (mH)***</b>								
Series	8.6	12	16.6	9.4	11.6	9.6	8.2	42.6
Parallel	2.2	3	4.2	2.4	2.9	2.4	2.1	10.7
<b>Drive Bus Voltage (VDC)</b>	170	170	170	170	170	170	170	170
<b>Detent Torque</b>								
oz-in (Nm)	2.5 (0.02)	4.0 (0.03)	7.0 (0.05)	8.8 (0.06)	18.0 (0.13)	27.0 (0.19)	41.7 (0.35)	81.0 (0.57)
<b>Bearings Information</b>								
<b>Thrust Load</b>								
lb (kg)	13 (5.9)	13 (5.9)	13 (5.9)	180 (81.6)	180 (81.6)	180 (81.6)	400 (182)	400 (182)
<b>Radial Load</b>								
lb (kg)	20 (9.1)	20 (9.1)	20 (9.1)	35 (15.9)	35 (15.9)	35 (15.9)	140 (63.6)	140 (63.6)
<b>End Play (Reversing load equal to 1 lb)</b>								
in (mm)	0.001 (0.025)	0.001 (0.025)	0.001 (0.025)	0.001 (0.025)	0.001 (0.025)	0.001 (0.025)	0.001 (0.025)	0.001 (0.025)
<b>Radial Play (Per 0.5 lb load)</b>								
in (mm)	0.0008 (0.02)	0.0008 (0.02)	0.0008 (0.02)	0.0008 (0.02)	0.0008 (0.02)	0.0008 (0.02)	0.0008 (0.02)	0.0008 (0.02)
<b>Motor Weight</b>								
lb (kg)	1 (0.5)	1.5 (0.7)	2.5 (1.1)	3.2 (1.5)	5.3 (2.4)	7.6 (3.5)	18.2 (8.3)	18.2 (8.3)
<b>Certifications</b>								
UL recognized	No	No	No	Yes	Yes	Yes	Yes	Yes
CE (LVD)	Yes	Yes	Yes	Yes	Yes	Yes	Yes	Yes
CE (EMC & LVD)*	No	No	No	*	*	*	*	*

## T Series Motors

Parameters	Size 34 Frame			Size 42 Frame		
	TS31B	TS32B	TS33B	TS41B	TS42B	TS43B
<b>Static torque**</b>						
oz-in (N-m)	455 (3.19)	647 (4.53)	1525 (10.68)	1332 (9.32)	2515 (17.61)	3479 (24.35)
<b>Rotor inertia</b>						
oz-in <sup>2</sup> (kg-cm <sup>2</sup> )	7.80 (1.43)	14.67 (2.68)	21.89 (4.01)	30.22 (5.53)	59.68 (10.92)	88.51 (16.20)
<b>Drive Current (Apk)(Arms)**</b>						
Series	3.3 (2.3)	3.1 (2.2)	5.6 (4.0)	6.4 (4.5)	6.7 (4.7)	6.9 (4.9)
Parallel	6.7 (4.7)	6.2 (4.4)	12.0 (8.5)	12.0 (8.5)	12.0 (8.5)	12.0 (8.5)
<b>Drive Bus Voltage (VDC)</b>	170	170	170	170	170	170
<b>Phase Inductance (mH)***</b>						
Series	10.3	10.3	13.6	15.8	22.0	30.7
Parallel	2.6	2.6	3.4	3.9	5.5	7.7
<b>Detent Torque</b>						
oz-in (Nm)	18 (0.13)	36 (0.25)	54 (0.38)	42 (0.30)	84 (0.59)	106 (0.75)
<b>Bearings Information</b>						
<b>Thrust Load</b>						
lb (kg)	305 (139)	305 (139)	305 (139)	404 (184)	404 (184)	404 (184)
<b>Radial Load</b>						
lb (kg)	65 (30)	65 (30)	110 (50)	125 (57)	110 (50)	110 (50)
<b>End Play (Reversing load equal to 1 lb)</b>						
in (mm)	0.001 (0.025)	0.001 (0.025)	0.001 (0.025)	0.001 (0.025)	0.001 (0.025)	0.001 (0.025)
<b>Radial Play (Per 0.5 lb load)</b>						
in (mm)	0.0008 (0.020)	0.0008 (0.020)	0.0008 (0.020)	0.0008 (0.020)	0.0008 (0.020)	0.0008 (0.020)
<b>Motor Weight</b>						
lb (kg)	5.0 (2.3)	8.4 (3.8)	11.9 (5.4)	11.0 (5.0)	18.4 (8.4)	25.7 (11.7)
<b>Certifications</b>						
UL recognized	Yes	Yes	Yes	Yes	Yes	Yes
CE (LVD)	Yes	Yes	Yes	Yes	Yes	Yes
CE (EMC & LVD)*	*	*	*	*	*	*

**E Series Motors**

Parameters	Size 23 Frame			Size 34 Frame		
	ES21-xxR10 (ZETA57-51)	ES22-xxR10 (ZETA57-83)	ES23-xxR10 (ZETA57-102)	ES31-xxR10 (ZETA83-62)	ES32-xxR10 (ZETA83-93)	ES33-xxR10 (ZETA83-135)
<b>Static torque</b>						
oz-in (N-m)	65 (0.46)	125 (0.88)	145 (1.02)	145 (1.02)	300 (2.12)	380 (2.68)
<b>Rotor inertia</b>						
oz-in <sup>2</sup> (kg-cm <sup>2</sup> )	0.546 (0.100)	1.10 (0.201)	1.69 (0.309)	3.47 (0.635)	6.76 (1.24)	10.47 (1.92)
<b>Phase Inductance (mH)</b>						
Series	mH (small signal*)	17.37	18.5	17	10	9.2
	mH (large signal**)	26.3	26.86	24.6	14.44	13.89
Parallel	mH (small signal*)	4.34	4.62	4.25	2.5	2.3
	mH (large signal**)	6.57	6.71	6.15	3.61	3.47
<b>Bearings Information</b>						
<b>Thrust Load</b>						
lb (kg)	25 (11.3)	25 (11.3)	25 (11.3)	50 (22.6)	50 (22.6)	50 (22.6)
<b>Radial Load</b>						
lb (kg)	15 (6.8)	15 (6.8)	15 (6.8)	25 (11.3)	25 (11.3)	25 (11.3)
<b>End Play (Reversing load equal to 1 lb)</b>						
in (mm)	0.005 (0.13)	0.005 (0.13)	0.005 (0.13)	0.005 (0.13)	0.005 (0.13)	0.005 (0.13)
<b>Radial Play (Per 0.5 lb load)</b>						
in (mm)	0.0008 (0.020)	0.0008 (0.020)	0.0008 (0.020)	0.0008 (0.020)	0.0008 (0.020)	0.0008 (0.020)
<b>Motor Weight (Motor + Cable + Connector)</b>						
lb (kg)	1.6 (0.7)	2.4 (1.1)	3.2 (1.5)	3.8 (1.7)	5.1 (2.3)	8.3 (3.8)
<b>Motor Cable Wire Size</b>						
AWG (mm <sup>2</sup> )	24 (0.25)	24 (0.25)	24 (0.25)	22 (0.34)	22 (0.34)	22 (0.34)

All motors: R10 cable length = 10 ft (3 m); flying leads (no connector) on end.

\* Small Signal Inductance is found by using an inductance bridge or meter.

\*\* Large Signal Inductance is found by measuring actual generator AC flux linkage and generator short circuit current under dynamic conditions.



# Dimensions

## Dimensions in inches (mm)

### O Series Motors, Size 23 Frame

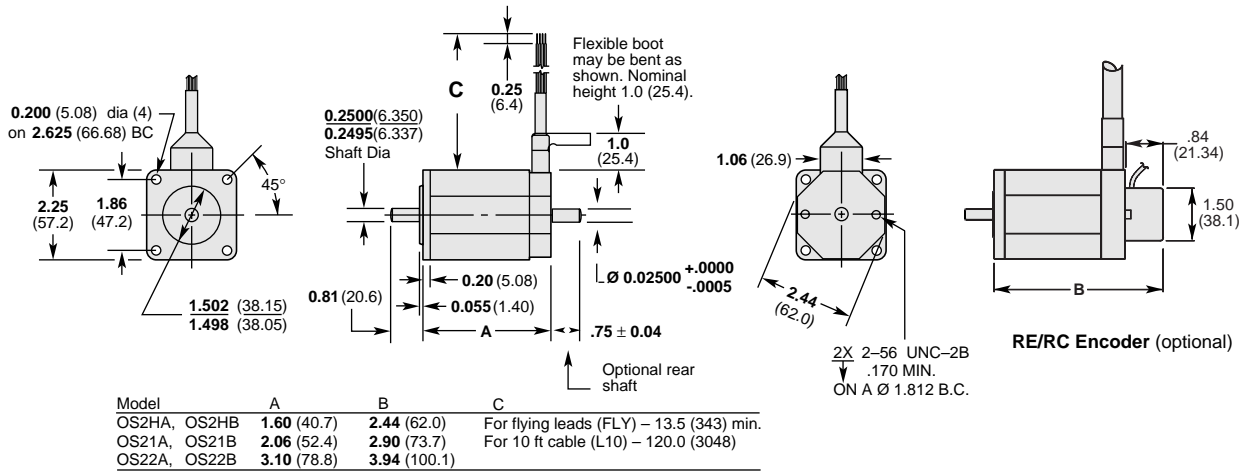

### R Series Motors, Size 34 Frame

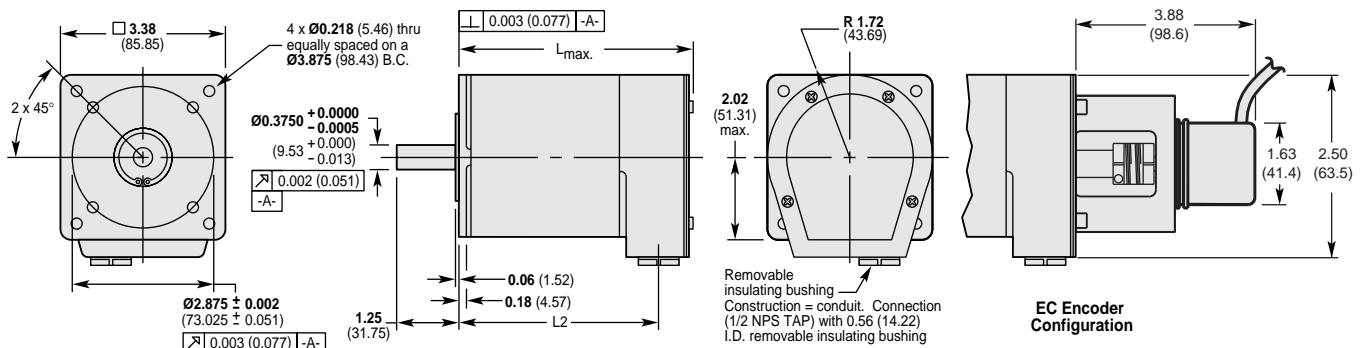

#### Standard Front Shaft Configurations

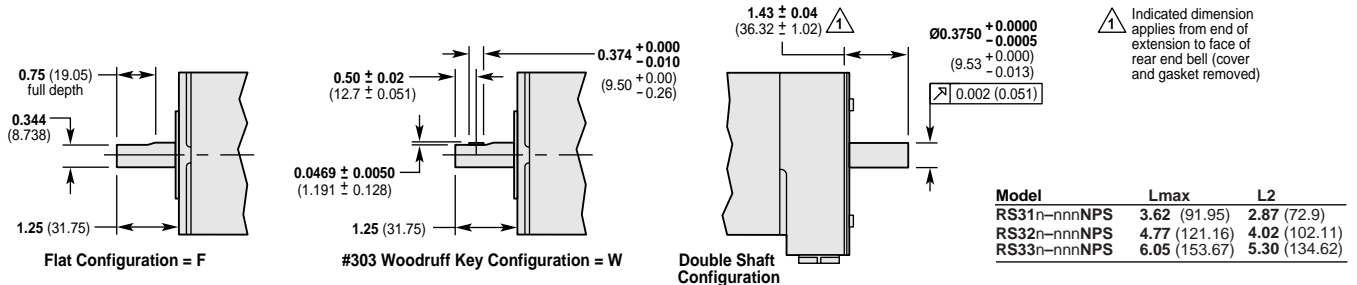

R Series Motors, Size 42 Frame

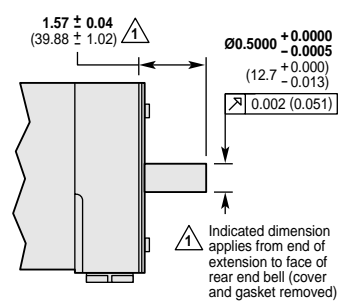
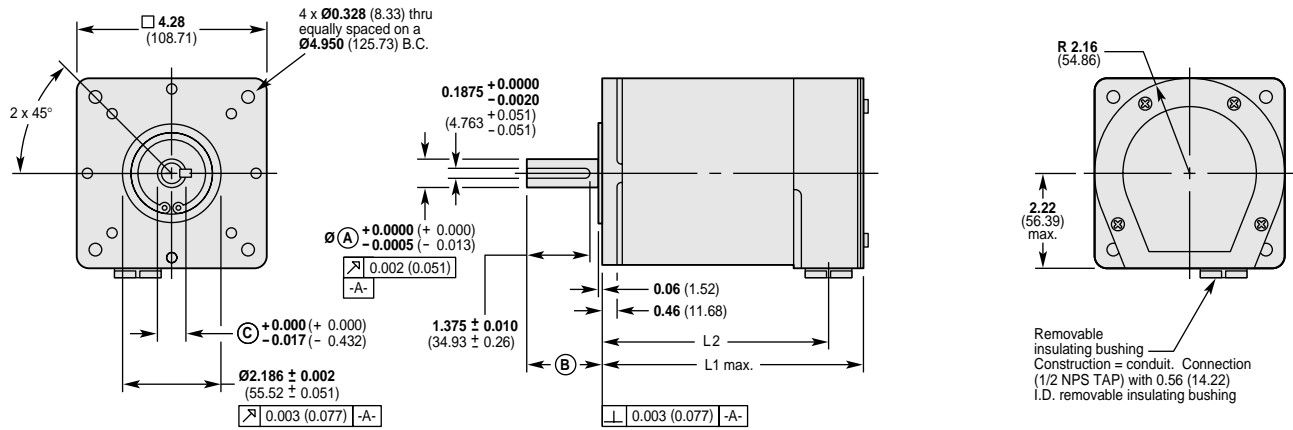

Double Shaft Configuration

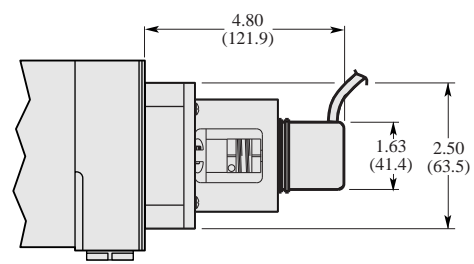

EC Encoder Configuration

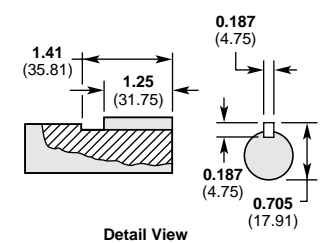

Detail View

Model	Lmax	L2	A	B	C
RS42n-nnnNPS	8.04 (204.22)	7.29 (185.17)	0.625 (15.87)	2.19 (55.63)	0.705 (17.91)
RE42n-nnnNPS	8.04 (204.22)	7.29 (185.17)	0.625 (15.87)	2.19 (55.63)	0.705 (17.91)
RE43n-nnnNPS	10.56 (268.23)	9.81 (249.18)	0.75 (19.05)	2.19 (55.63)	0.83 (21.09)

### T Series Motors, Size 34 Frame

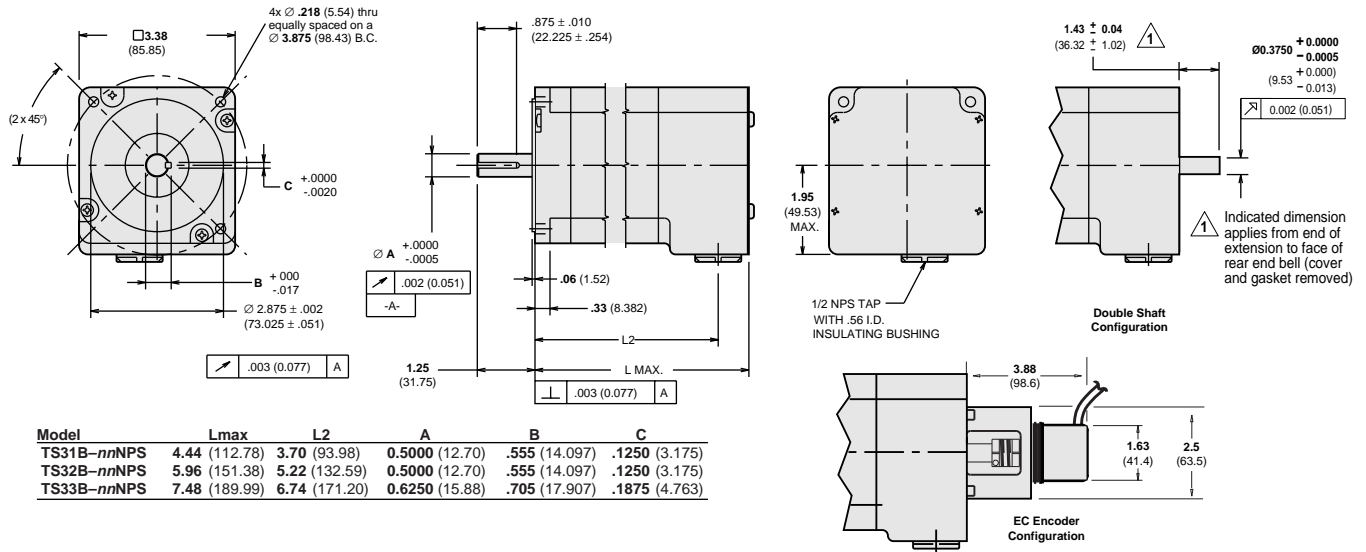

### T Series Motors, Size 42 Frame

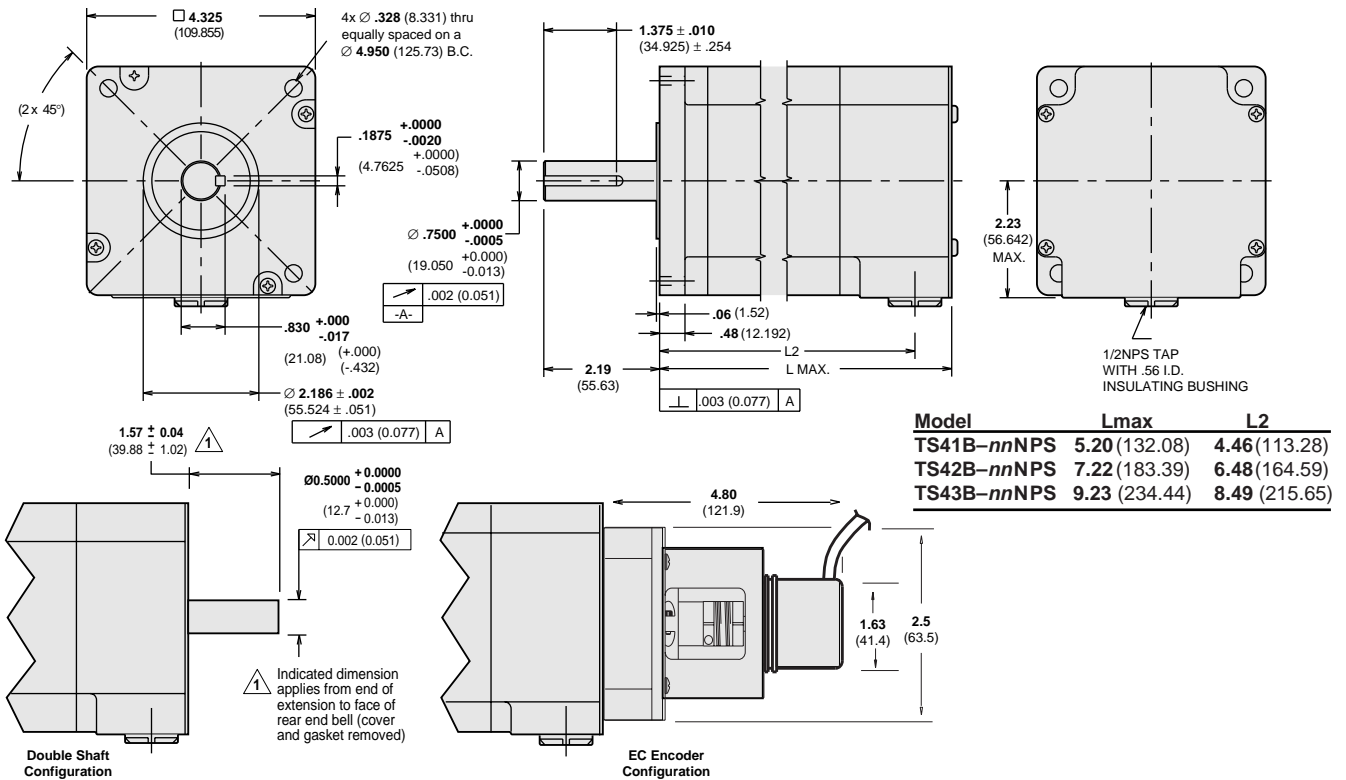

### E Series Motors, Size 23 Frame

Model	A
ES21B	2.0 (50.23)
ES22B	3.1 (75.23)
ES23B	4.0 (101.6)

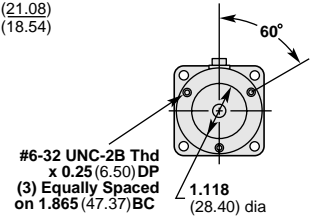
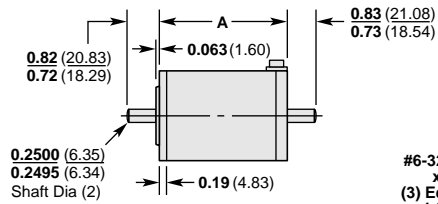
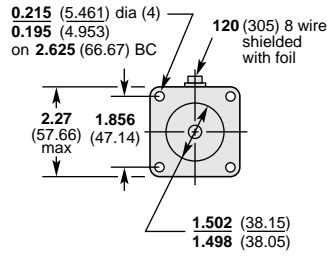

### E Series Motors, Size 34 Frame

Model	A
ES31B	2.5 (62.0)
ES32B	3.7 (93.98)
ES33B	5.2 (129.0)

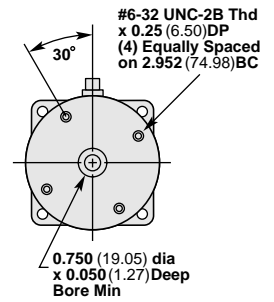
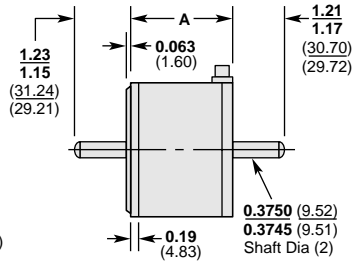
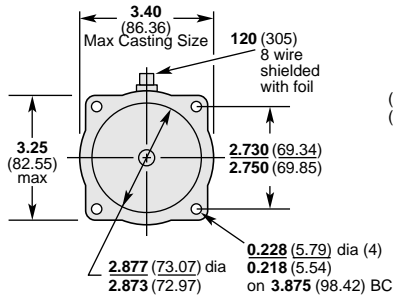

# Step Motor Wiring

## O Motors and E Motors

O and E motors can be wired in series or parallel. The following cabling options are available:

Motor	Option	Description of Option:	Cable Length:
O	-FLY	Regular construction with 8 flying leads,	12 inches (0.3 m)
	-L10	Regular construction with LVD cable,	10 feet (3 m)
E	-R10	Regular construction, cable, with flying leads	10 feet (3 m)

### Series Wiring

*O or E Motor – Series Wiring*

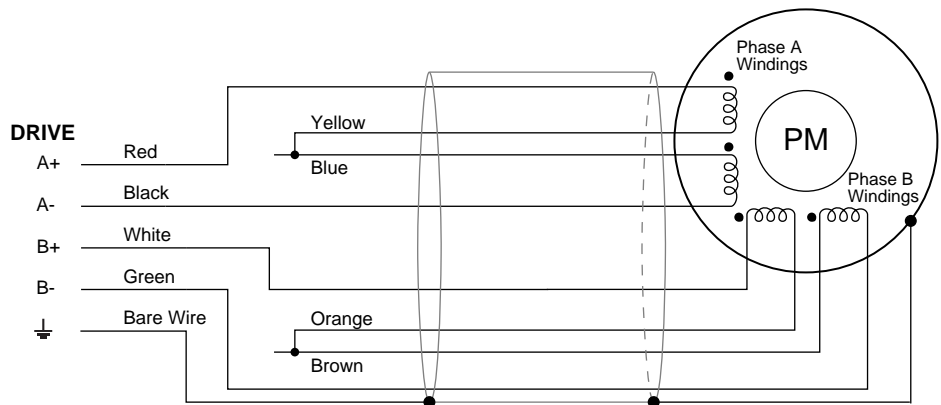

### Parallel Wiring

*O or E Motor – Parallel Wiring*

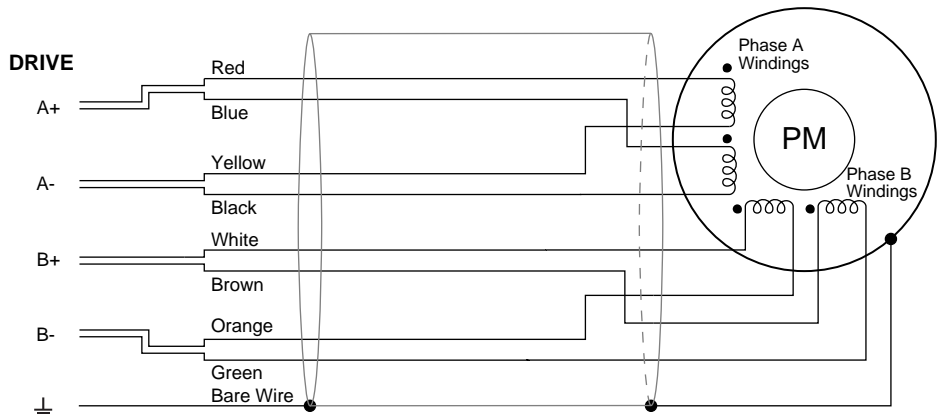

**R Motors and  
T Motors**

The following cabling options are available for R and T motors:

Option	Description of Option:	Cable Length:
NPS	End bell/terminal board with 1/2" NPS pipe thread	No cable
S10	CE (LVD)/UL, NPS construction, motor wired in series	10 feet (3 m)
P10	CE (LVD)/UL, NPS construction, motor wired in parallel	10 feet (3 m)

**Series Wiring**

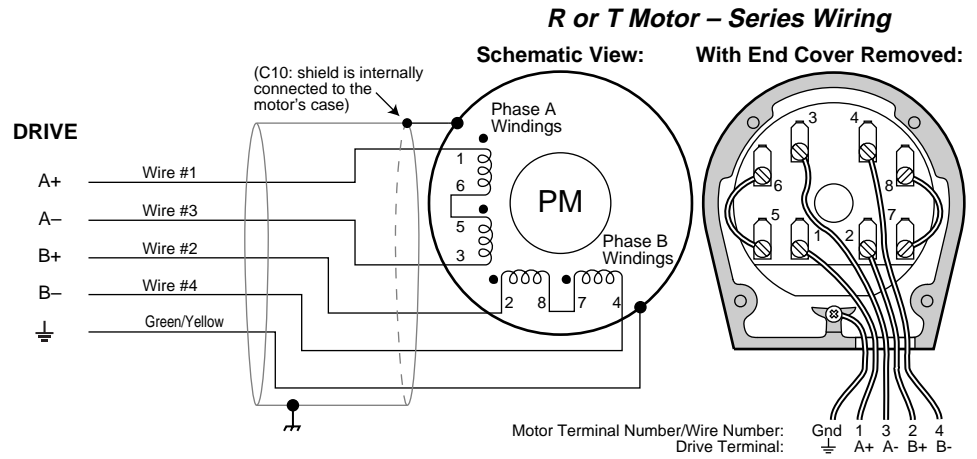

**Parallel Wiring**

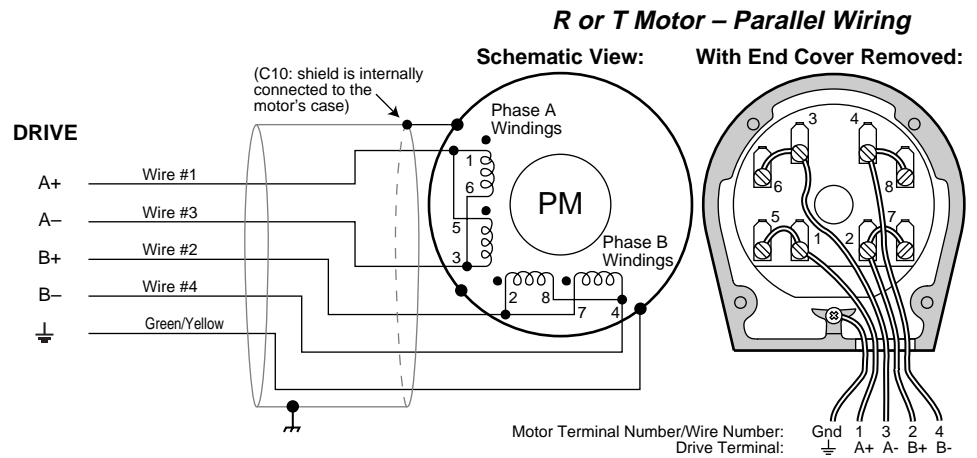

## Encoder Information

### Encoder Specifications

	-E and -EC Encoders	-RE and -RC Encoders
<b>Mechanical</b>		
Starting Torque at 77°F (25°C)	oz-in 0.5 (Nm) (0.003)	Not applicable Not applicable
Moment of inertia	oz-in sec <sup>2</sup> 0.22	4.4 x 10 <sup>-5</sup>
Weight	oz 10 (kg) (0.28)	2 (0.057)
Bearing Life	Revolutions 1x10 <sup>9</sup>	Not applicable
Max operating speed	3,000 rpm	6,000 rpm
<b>Electrical</b>		
Input power	5VDC±5%, 125mA	5VDC±5%, 135mA
Output format	2 channels (A and B) quadrature Z channel once/rev	2 channels (A and B) quadrature Z channel once/rev
<b>Environmental</b>		
Operating Temperature	32°F to 158°F (0°C to 70°C)	14°F to 185°F (-10°C to 85°C)
Storage Temperature	32°F to 158°F (0°C to 70°C)	-22°F to 230°F (-30°C to 110°C)
Shock	10 G's for 11 msec duration	50 G's for 11 msec duration
Vibration	5 G's at 10 Hz to 2,000 Hz	10 G's at 20 Hz to 2,000 Hz

### Encoder Cable – Color Code

-E and -EC option encoders come standard with a 10-foot cable and 25-pin D-connector.

-RE option encoders come standard with 13 inch flying leads.

-RC option encoders come standard with a 10-foot cable.

25-Pin D No. (E/EC only):	Color Code – All Encoders Color:	Description:
1	Brown	Channel A
2	Brown/White	Channel A return
3	Green	Channel B
4	Green/White	Channel B return
5	Orange	Channel Z
6	Orange/White	Channel Z return
7	—	NC
8	Shield	Case ground
9 – 13	—	NC
14	Black	Common
15 – 22	—	NC
23	Red	5VDC
24 – 25	—	NC

### Encoder Dimensions

Encoder dimensions are shown in the dimension drawing for each motor.





## Recommended Drive/Motor Systems

The following motors are recommended for use with drives listed in the *Recommended Drive Type* column.

Servo Motor Model Number	Recommended Drive Type	Step Motor Model Number	Drive Type Recommended	Step Motor Model Number	Drive Type Recommended
SM161A	GV-L3E	OS2HA-xxFLY (series)	GT-U5	RS42B-xxS10 (series)	GT-L8
SM162A	GV-L3E	OS21A-xxFLY (series)	GT-U5	RE42B-xxS10 (series)	GT-L8
SM231A	GV-L3E	OS22A-xxFLY (series)	GT-U5		
SM232A	GV-L3E			RS42B-xxP10 (parallel)	GT-L8
SM233A	GV-L3E	OS2HA-xxL10 (series)	GT-U5	RE42B-xxP10 (parallel)	GT-L8
		OS21A-xxL10 (series)	GT-U5		
		OS22A-xxL10 (series)	GT-U5	TS31B-xxS10 (series)	GT-L5
N0701D	GV-U6E			TS32B-xxS10 (series)	GT-L8
N0701F	GV-U6E			TS33B-xxS10 (series)	GT-L8
N0702E	GV-U6E	OS2HA-xxFLY (parallel)	GT-U8		
N0702F	GV-U6E	OS21A-xxFLY (parallel)	GT-U8		
N0703F	GV-U6E	OS22A-xxFLY (parallel)	GT-U8	TS31B-xxP10 (parallel)	GT-L8
N0703G	GV-U12E			TS32B-xxP10 (parallel)	GT-L8
N0704F	GV-U6E	OS2HA-xxL10 (parallel)	GT-U8	TS33B-xxP10 (parallel)	GT-L8
N0704G	GV-U12E	OS21A-xxL10 (parallel)	GT-U8		
		OS22A-xxL10 (parallel)	GT-U8	TS41B-xxS10 (series)	GT-L8
J0701D	GV-U6E			TS42B-xxS10 (series)	GT-L8
J0701F	GV-U6E	OS2HB-xxFLY (series)	GT-L5	TS43B-xxS10 (series)	GT-L8
J0702E	GV-U6E	OS21B-xxFLY (series)	GT-L5		
J0702F	GV-U6E	OS22B-xxFLY (series)	GT-L5	TS41B-xxP10 (parallel)	GT-L8
J0703F	GV-U6E			TS42B-xxP10 (parallel)	GT-L8
J0703G	GV-U12E	OS2HB-xxL10 (series)	GT-L5	TS43B-xxP10 (parallel)	GT-L8
		OS21B-xxL10 (series)	GT-L5		
N0921F	GV-U6E	OS22B-xxL10 (series)	GT-L5	ES21B-xxR10 (series)	GT-L5
N0921G	GV-U12E			ES22B-xxR10 (series)	GT-L5
N0922G	GV-U12E			ES23B-xxR10 (series)	GT-L5
N0922J	GV-U12E	OS2HB-xxFLY (parallel)	GT-L5		
NO923H	GV-U12E	OS21B-xxFLY (parallel)	GT-L5		
NO923K	GV-H20E	OS22B-xxFLY (parallel)	GT-L5	ES21B-xxR10 (parallel)	GT-L5
NO924J	GV-U12E			ES22B-xxR10 (parallel)	GT-L5
NO924K	GV-H20E	OS2HB-xxL10 (parallel)	GT-L5	ES23B-xxR10 (parallel)	GT-L5
		OS21B-xxL10 (parallel)	GT-L5		
J0921F	GV-U6E	OS22B-xxL10 (parallel)	GT-L5	ES31B-xxR10 (series)	GT-L5
J0921G	GV-U12E			ES32B-xxR10 (series)	GT-L5
J0922G	GV-U12E	RS31B-xxS10 (series)	GT-L5	ES33B-xxR10 (series)	GT-L5
J0922J	GV-U12E	RS32B-xxS10 (series)	GT-L8		
J0923H	GV-U12E	RS33B-xxS10 (series)	GT-L8	ES31B-xxR10 (parallel)	GT-L5
J0923K	GV-H20E			ES32B-xxR10 (parallel)	GT-L8
		RS31B-xxP10 (parallel)	GT-L8	ES33B-xxR10 (parallel)	GT-L8
		RS32B-xxP10 (parallel)	GT-L8		
		RS33B-xxP10 (parallel)	GT-L8		
<b>Linear Servo Motor Table:</b>	<b>Recommended Drive Type:</b>				
406LXR-D13	GV-L3E or GV-U6E*				
406LXR-D15	GV-L3E or GV-U6E*				
	*GV-U6E at 16 kHz PWM only				