



Flexflow

ISO Valves

ISO 5599-1, sizes 1 to 3

Catalogue PDE2596TCUK-ev
Edition : July 2007



Summary

ISO specification.....	3 - 5
------------------------	-------

Flexflow

Highlight.....	6 - 7
Flow characteristic / Material.....	8 - 9
Order Key	10 - 13
Subbases, Manifolds.....	14 - 15
Solenoids.....	16 - 18
Connectors.....	19
Dimensions.....	20 - 26



Important !

Before carrying out any service work, ensure that the valve and manifold have been vented. Remove the primary supply air hose to ensure total disconnection of the air supply before dismantling valves or blank connection blocks.



NB !

All technical data in this catalogue is typical only. The air quality is decisive for the valve life: see ISO 8573.



WARNING

FAILURE OR IMPROPER SELECTION OR IMPROPER USE OF THE PRODUCTS AND/OR SYSTEMS DESCRIBED HEREIN OR RELATED ITEMS CAN CAUSE DEATH, PERSONAL INJURY AND PROPERTY DAMAGE.

This document and other information from Parker Hannifin Corporation, its subsidiaries and authorized distributors provide product and/or system options for further investigation by users having technical expertise. It is important that you analyze all aspects of your application and review the information concerning the product or system in the current product catalog. Due to the variety of operating conditions and applications for these products or systems, the user, through its own analysis and testing, is solely responsible for making the final selection of the products and systems and assuring that all performance, safety and warning requirements of the application are met. The products described herein, including without limitation, product features, specifications, designs, availability and pricing, are subject to change by Parker Hannifin Corporation and its subsidiaries at any time without notice.

SALE CONDITIONS

The items described in this document are available for sale by Parker Hannifin Corporation, its subsidiaries or its authorized distributors. Any sale contract entered into by Parker will be governed by the provisions stated in Parker's standard terms and conditions of sale (copy available upon request).



5599-1



ISO 5599-1

External electrical connection subbase valves

The ISO Standard 5599-1 specifies an interface pattern for a common subbase valve consisting of pressure passages 1, 3, 5, 2 & 4 and pilot passages 12 & 14. The width of the pattern and location of the 4 bolt holes are also specified. There are no specifications for the type of external electrical connection used to control the valve.

Size : 1 2 3



5599-2



ISO 5599-2

Body-to-base plug-in subbase valves

Same as 5599-1 for pneumatic pressure passages, 5599-2 standard also specifies a plug-in electrical connection.

Sizes : 1 2 3

Electrical connector

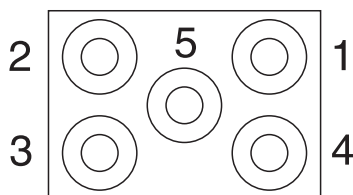

- 1 = 12 solenoid
- 2 = 14 solenoid
- 3 = 12 solenoid
- 4 = 14 solenoid
- 5 = Ground



15407-1

(VDMA 24563)



ISO 15407-1

External electrical connection subbase valves

The ISO Standard 15407-1 specifies an interface pattern for a common subbase valve consisting of pressure passages 1, 3, 5, 2 & 4 and pilot passages 12 & 14. The width of the pattern and location of the 4 bolt holes are also specified. There are no specifications for the type of external electrical connection used to control the valve.

Size : 02 01



15407-2



ISO 15407-2

Body-to-base plug-in subbase valves

Same as 15407-1 for pneumatic pressure passages, 15407-2 standard also specifies a plug-in electrical connection.

Size : 01 02

Electrical connector

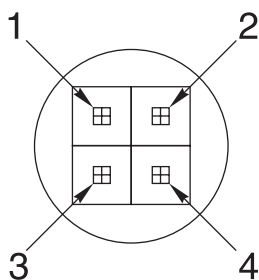

Pin 1 = 14 solenoid

Pin 2 = 12 solenoid

Pin 3 = Ground +

Pin 4 = Common -

ISO Specifications

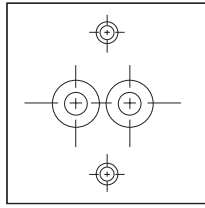

CNOMO 06-05-01

The solenoid pilot interface often used with ISO 5599-1 valves is the CNOMO interface. The CNOMO interface specifies the pressure and actuator port, and the screw holes for the mounting of this solenoid pilot. It is commonly used in European automotive plants, and its usage is becoming more prevalent for industrial ISO 5599-1 valves.

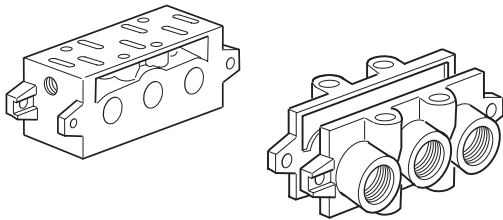

VDMA 24345

The VDMA 24345 is a standard for Manifolds and Subbase specifying a common base mounting footprint in addition to ISO 5599-1 Interface standard. (VDMA is a German organisation - Verband Deutscher Maschinen und Anlagen-Bauer - which is translated to Federation of German Machine and Unit Builders.)

Choice of components for air supply to cylinders

In the chart below can you find the suitable valves, tubes etc. for each cylinder size. If you have a tube length over 2 m, choose one tube size larger than in the chart.

Following data is valid :
 Supply pressure: min 7,0 bar
 Regulator pressure setting: 6,0 bar
 Pipe length between air treatment unit and valve: max 1 m
 Pipe length between valve and cylinder : max 2 m

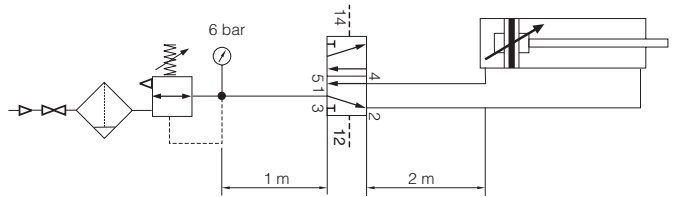

Cylinder bore	<Ø20	Ø20-32	Ø40-50	Ø63	Ø80	Ø100	Ø125	Ø160	Ø200
Cylinder port	M5	G1/8	G1/4	G3/8	G3/8	G1/2	G1/2	G3/4	G3/4
Tubing Ext / Int	4 / 2.7	6 / 4	8 / 6	10 / 7	10 / 7 12 / 9	12 / 9 14 / 11	14 / 11	18 / 15	20 / 18
Size 1	G1/4	G1/4	G1/4	G1/4	G1/4	G1/4			
Size 2				G3/8	G3/8	G3/8	G3/8		
Size 3				G1/2	G1/2	G1/2	G1/2	G1/2	G1/2

Cylinder speed < 0.5 m/s
 Cylinder speed < 1 m/s
 Cylinder speed > 1 m/s
 Oversizing

Highlight

Flexflow - General Applications

Market Application

- Automotive Handling
- Packaging
- Manufacturing
- General application

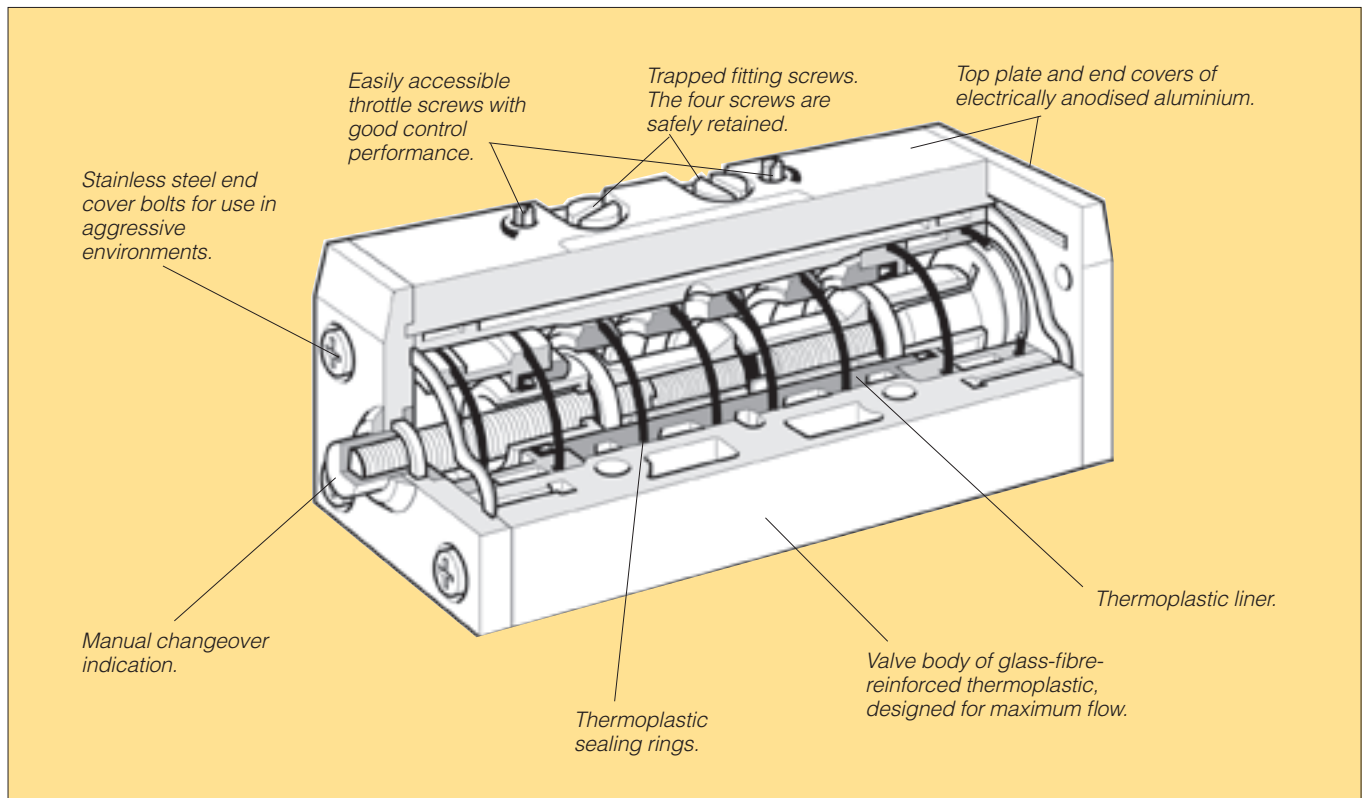

Highlight

International standard

The VG25, VG35 and VG45 are all fully interchangeable, in accordance with ISO 5599/1. The range includes electrically-operated valves for use as pilot valves that comply with the French CNOMO standard, and there are also standardised manifolds that comply with the German VDMA 24345.

Compact, corrosion-resistant design

The valves combine high flow capacity with small size, while the smooth shape meets high hygiene requirements. Electrically anodised aluminium and stainless steel end cover bolts mean that the valves are suited for use in difficult environments as standard.

High reliability

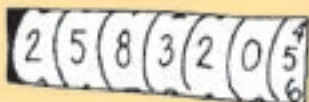

Valves easily comply with the requirements for the component reliability in accordance with EU Machinery Directive standards EN292-2 and EN983.

Lubrication and maintenance-free for long life

The use of high-molecular plastic with inherent lubricating properties means that the VG25, VG35 and VG45 are suitable for use with or without additional lubrication. In addition, the design principle ensures many years of reliable operation.

Manual Override as standard

Solenoids are available with non-locking manual overrides so that valves can be operated when the electrical supply is turned off. Locking or no manual override as option.

Solenoid valves, 22 mm solenoid or CNOMO interface



Standard valve is fitted with a 22 mm solenoid having Industrial connector for sizes 1, 2 and 3. CNOMO Interface also available for all sizes, as option.

Integral speed control

Ports 3 and 5 incorporate throttle screws for control of cylinder operation speeds. The screws are accessibly mounted on the top of the valves. A wide control range in several steps ensures excellent speed control of both large and small cylinders.

High electrical encapsulation class



The solenoid valves are protected to IP65 with the standard cable plug.

Wide choice of solenoid connectors/cable plugs



Solenoid connectors are available with or without LED and rectifier and may be selected fitted pre-wired with flying leads.

Manual changeover - indication

Commissioning and service are assisted by the incorporation of large, ergonomically designed pushbuttons for manual changeover as standard in all the valves in the range.

Bottom or side ported manifold

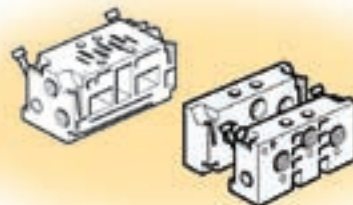

Manifolds with common ducts for ports 1,3 and 5, outlet port 2 and 4, and supply port for 12 and 14 are available side or bottom ported.

Subbase installation VDMA 25345

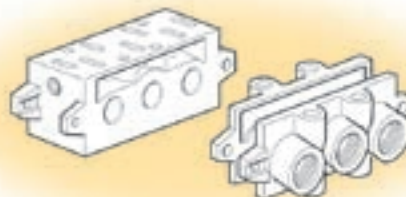

A large range of subbase, VDMA or not VDMA, bottom or side ported.

Flow characteristics

Flow Characteristics

Flow capacities in accordance with ISO6358
All pressures = effective pressure

VG25 - ISO 1

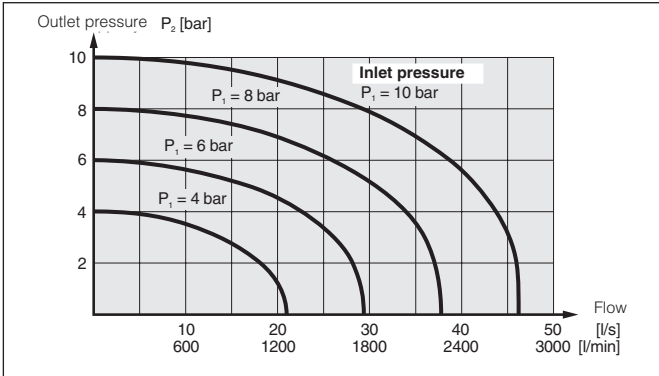

Operating pressure :

5/2 Spring return 3,5 - 10 bar
5/2 Double solenoid 1,5 - 10 bar

Working temperature : electrical -10°C to + 60°C
pneumatic -20°C to + 70°C

Flow (acc. to ISO 6358) c = 4,2 NI/s x bar
b = 0,20
Qn = 17,0 l/s
Qmax = 29,4 l/s

VG35 - ISO 2

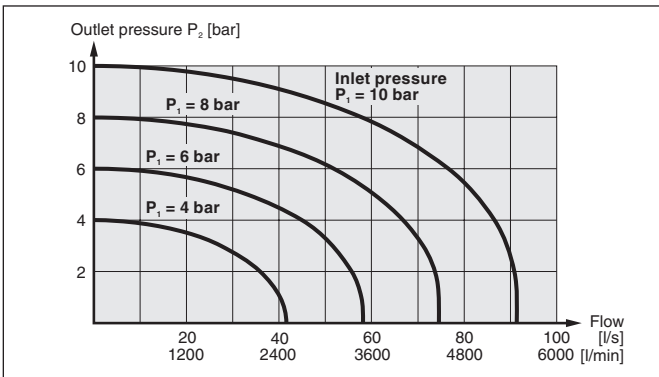

Operating pressure :

5/2 Spring return 3,5 - 10 bar
5/2 Double solenoid 1,5 - 10 bar

Working temperature : electrical -10°C to + 60°C
pneumatic -20°C to + 70°C

Flow (acc. to ISO 6358) c = 8,3 NI/s x bar
b = 0,20
Qn = 33,0 l/s
Qmax = 58,0 l/s

VG45 - ISO 3

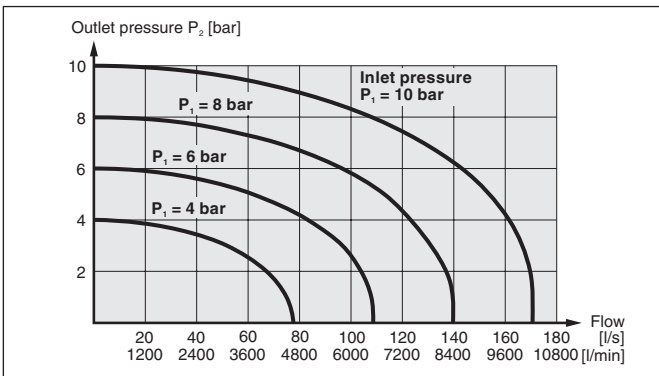

Operating pressure :

5/2 Spring return 2,0 - 10 bar
5/2 Double solenoid 1,0 - 10 bar

Working temperature : electrical -10°C to + 60°C
pneumatic -20°C to + 70°C

Flow (acc. to ISO 6358) c = 15,5 NI/s x bar
b = 0,20
Qn = 62,0 l/s
Qmax = 108,0 l/s

Material Specification and Characteristics

5599

Valve body	Acetal plastic
Spool	Acetal plastic
Spool seal	High-molecular thermoplastic
U-rings, O-rings	Nitrile rubber, NBR
Sleeves	Thermoplastic
Piston	Acetal plastic
End covers	Electrically anodised aluminium
Top plate	Electrically anodised aluminium
End seals	Nitrile rubber, NBR
Seal, top plate	Nitrile rubber, NBR
Manual changeover push-button	Acetal plastic
Throttle screws	Galvanised brass
Throttle inserts	Acetal plastic
End cover bolts	Stainless steel
Mounting screws	Galvanised steel (standard)
Manifolds	Electrically anodised aluminium

Characteristics

Fluid	Air or inert gas filtered 40u class 5 according to ISO 8573-1 dry class 4 according to ISO 8573-1 non-lubricated, or lubricated
Storage temperature	-20° to + 70°
Vibration	2G 2 to 150Hz according to IEC 68-2-6
Shock	15G 11ms according to IEC 68-2-7
Manual override	Non-locking, other type on request
Solenoid : please see pages 16 - 20	

Certification

EMC / CE mark.	According to EN 61 000-6-2
Dust & water protection	IP65 according to EN 60529

Flexflow - ISO 5599 - Size 1 / 2 / 3

Order chart

VG

25

-

ERER

-

D

B

-

49

Size	
25	Size 1 (ISO 5599)
35	Size 2 (ISO 5599)
45	Size 3 (ISO 5599)

Voltage	
	DC
49	24 V

Blank valve without coil

Valve type function		
Pneumatic pilot		
AA		5/2 double air
AS		5/2 spring return
XAC		5/3 double air vened centre
AC		5/3 double air closed centre
YAC		5/3 double air pressurised centre
Internal supply		
ERER		5/2 double solenoid
ERS		5/2 single solenoid spring return
ERDR		5/2 single solenoid, differential return
ERC		5/3 double solenoid vented centre
XERC		5/3 double solenoid closed centre
YERC		5/3 double solenoid pressurised center
External supply 14 & 12		
EAEA		5/2 double solenoid
EAS		5/2 single solenoid spring return
EAC		5/3 double solenoid vented centre
XEAC		5/3 double solenoid closed centre
YEAC		5/3 double solenoid pressurised centre





Solenoid enclosure	
B	22 mm 3-pin industrial
N	Solenoid less coil
L	CNOMO 3 -pin Din A

Overrides	
A	None
B	Flush non locking
C	Flush locking
D	Extended non locking

Shaded part numbers are standard

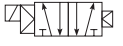

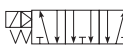



Solenoid operated ISO valve fitted with 22 mm solenoid(s) 24 VDC

Solenoid plug/connector to be ordered separately. See page 19.

Symbol	Size	Actuation	Return	Signal pressure min. (bar) at 6 bar actua./return	Changeover time (ms) at 6 bar actua./return	Weight kg	Order code		
5/2 Valves									
	1 - 43mm	Electrical signal	Spring	3,5	15/25	0.50	VG25-ERS-DB49 VG35-ERS-DB49 VG45-ERS-DB49		
	2 - 56mm			3,5	30/60	0.75			
	3 - 71mm			3,5	40/90	1.25			
	1 - 43mm	Electrical signal	Differential	3,5	15/25	0.50	VG25-ERDR-DB49 VG35-ERDR-DB49		
	2 - 56mm			3,5	30/60	0.75			
	1 - 43mm	Electrical signal	Electrical signal	1,5/1,5	15/15	0.65	VG25-ERER-DB49 VG35-ERER-DB49 VG45-ERER-DB49		
	2 - 56mm			1,5/1,5	25/25	0.90			
	3 - 71mm			1,5/1,5	30/30	1.40			
5/3 Valves									
	1 - 43mm	Electrical signal	Electrical signal	3,5	25/30	0.65	VG25-ERC-DB49 VG35-ERC-DB49 VG45-ERC-DB49		
	2 - 56mm			Closed center	Self centering	3,5		40/65	0.90
	3 - 71mm					3,5		50/100	1.40
	1 - 43mm	Electrical signal	Electrical signal	3,5	25/30	0.65	VG25-XERC-DB49 VG35-XERC-DB49 VG45-XERC-DB49		
	2 - 56mm			Vented center	Self centering	3,5		40/65	0.90
	3 - 71mm					3,5		50/100	1.40
	1 - 43mm	Electrical signal	Electrical signal	3,5	25/30	0.65	VG25-YERC-DB49		
		Pressure center	Self centering						





Solenoid operated ISO valve fitted with 22 mm operator without coil

Coils, solenoid plug/connector to be ordered separately. See pages 18 and 19.

Symbol	Size	Actuation	Return	Signal pressure min. (bar) at 6 bar actua./return	Changeover time (ms) at 6 bar actua./return	Weight kg	Order code		
5/2 Valves									
	1 - 43mm	Electrical signal	Spring	3,5	15/25	0.40	VG25-ERS-DN VG35-ERS-DN VG45-ERS-DN		
	2 - 56mm			3,5	30/60	0.65			
	3 - 71mm			3,5	40/90	1.15			
	1 - 43mm	Electrical signal	Differential	3,5	15/25	0.40	VG25-ERDR-DN VG35-ERDR-DN		
	2 - 56mm			3,5	30/60	0.65			
	1 - 43mm	Electrical signal	Electrical signal	1,5/1,5	15/15	0.55	VG25-ERER-DN VG35-ERER-DN VG45-ERER-DN		
	2 - 56mm			1,5/1,5	25/25	0.80			
	3 - 71mm			1,5/1,5	30/30	1.30			
5/3 Valves									
	1 - 43mm	Electrical signal	Electrical signal	3,5	25/30	0.55	VG25-ERC-DN VG35-ERC-DN VG45-ERC-DN		
	2 - 56mm			Closed center	Self centering	3,5		40/65	0.80
	3 - 71mm					3,5		50/100	1.30
	1 - 43mm	Electrical signal	Electrical signal	3,5	25/30	0.55	VG25-XERC-DN VG35-XERC-DN VG45-XERC-DN		
	2 - 56mm			Vented center	Self centering	3,5		40/65	0.80
	3 - 71mm					3,5		50/100	1.30
	1 - 43mm	Electrical signal	Electrical signal	3,5	25/30	0.55	VG25-YERC-DN		
		Pressure center	Self centering						

 Indicates stocked product.

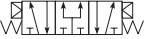

Pneumatic operated ISO valve

Symbol	Size	Actuation	Return	Signal pressure min. (bar) at 6 bar actua./return	Changeover time (ms) at 6 bar actua./return	Weight kg	Order code
5/2 Valves							
	1 - 43mm 2 - 56mm 3 - 71mm	Air signal	Spring	3,5/3,5 3,5/3,5 3,5/3,5	15/25 20/35 20/45	0.35 0.60 1.10	VG25-AS VG35-AS VG45-AS
	1 - 43mm 2 - 56mm 3 - 71mm	Air signal	Air signal	1,5/1,5 1,5/1,5 1,5/1,5	10/10 15/15 20/20	0.35 0.60 1.10	VG25-AA VG35-AA VG45-AA
5/3 Valves							
	1 - 43mm 2 - 56mm	Air signal Closed center	Air signal Self centering	3,5/3,5 3,5/3,5	15/25 20/30	0.35 0.60	VG25-AC VG35-AC
	1 - 43mm 2 - 56mm 3 - 71mm	Air signal Vented center	Air signal Self centering	3,5/3,5 3,5/3,5 3,5/3,5	15/25 20/30 20/35	0.35 0.60 1.10	VG25-XAC VG35-XAC VG45-XAC
	1 - 43mm	Air signal Pressure center	Air signal Self centering	3,5/3,5	15/25	0.35	VG25-YAC

 Indicates stocked product.

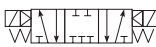
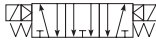

Solenoid operated ISO valve fitted with CNOMO solenoid(s) 24 VDC

Solenoid plug/connector to be ordered separately. See page 19.

Symbol	Size	Actuation	Return	Signal pressure min. (bar) at 6 bar actua./return	Changeover time (ms) at 6 bar actua./return	Weight kg	Order code
5/2 Valves							
	1 - 43mm	Electrical signal	Spring	3,5	15/25	0.50	VG25-ERS-BL49
	2 - 56mm			3,5	30/60	0.75	VG35-ERS-BL49
	3 - 71mm			3,5	40/90	1.25	VG45-ERS-BL49
	1 - 43mm	Electrical signal	Electrical signal	1,5/1,5	15/15	0.65	VG25-ERER-BL49
	2 - 56mm			1,5/1,5	25/25	0.90	VG35-ERER-BL49
	3 - 71mm			1,5/1,5	30/30	1.40	VG45-ERER-BL49
5/3 Valves							
	1 - 43mm	Electrical signal Closed center	Electrical signal Self centering	3,5	25/30	0.65	VG25-ERC-BL49
	2 - 56mm			3,5	40/65	0.90	VG35-ERC-BL49
	3 - 71mm			3,5	50/100	1.40	VG45-ERC-BL49
	1 - 43mm	Electrical signal Vented center	Electrical signal Self centering	3,5	25/30	0.65	VG25-XERC-BL49
	2 - 56mm			3,5	40/65	0.90	VG35-XERC-BL49
	3 - 71mm			3,5	50/100	1.40	VG45-XERC-BL49

Solenoid operated ISO valve fitted with CNOMO operator without coil

Coils, solenoid plug/connector to be ordered separately. See pages 18 et 19.

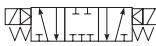
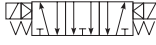
Symbol	Size	Actuation	Return	Signal pressure min. (bar) at 6 bar actua./return	Changeover time (ms) at 6 bar actua./return	Weight kg	Order code
5/2 Valves							
	1 - 43mm	Electrical signal	Spring	3,5	15/25	0.40	VG25-ERS-BN
	2 - 56mm			3,5	30/60	0.65	VG35-ERS-BN
	3 - 71mm			3,5	40/90	1.15	VG45-ERS-BN
	1 - 43mm	Electrical signal	Electrical signal	1,5/1,5	15/25	0.55	VG25-ERER-BN
	2 - 56mm			1,5/1,5	25/25	0.80	VG35-ERER-BN
	3 - 71mm			1,5/1,5	30/30	1.30	VG45-ERER-BN
5/3 Valves							
	1 - 43mm	Electrical signal Closed center	Electrical signal Self centering	3,5	25/30	0.55	VG25-ERC-BN
	2 - 56mm			3,5	40/65	0.80	VG35-ERC-BN
	3 - 71mm			3,5	50/100	1.30	VG45-ERC-BN
	1 - 43mm	Electrical signal Vented center	Electrical signal Self centering	3,5	25/30	0.55	VG25-XRC-BN
	2 - 56mm			3,5	40/65	0.80	VG35-XRC-BN
	3 - 71mm			3,5	50/100	1.30	VG45-XRC-BN

VDMA Side Ported Subbases

Description	Size	Port size	Weight kg	Order code
 <p>Subbase VDMA Side port according to VDMA</p>	1 - 43mm	G1/4	0.16	P2N-VS512SD
	2 - 56mm	G3/8	0.28	P2N-WS513SD
	3 - 71mm	G1/2	0.35	P2N-YS514SD

VDMA Bottom Ported Manifold

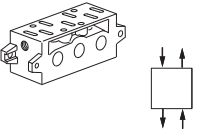
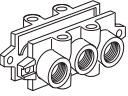
Description	Size	Port size	Weight kg	Order code
 <p>Subbase VDMA Form C Bottom port according to VDMA</p>	1 - 43mm	G1/4	0.24	P2N-VM512MB
	2 - 56mm	G3/8	0.36	P2N-WM513MB
	3 - 71mm	G1/2	0.70	P2N-YM514MB
<p>VDMA Transition plate Size 1 to Size 3 Kit includes: Transition plate only</p>	1 to 3	G1/4		P2N-VM500AK
 <p>VDMA Form D - End plate According to VDMA</p>	1 - 43mm	G3/8	0.21	P2N-VM513ES
	2 - 56mm	G1/2	0.36	P2N-WM514ES
	3 - 71mm	G1	0.68	P2N-YM518ES
<p>VDMA Isolation - Main galley According to VDMA</p> <p>For use with 2 different pressures.</p>	1 - 43mm 2 - 56mm 3 - 71mm			P2N-VK0P P2N-WK0P P2N-YK0P

Accessories

Description	Size	Port size	Weight kg	Order code
 <p>Blanking plate Kit includes: 1 Blanking plate, Gasket and 4 Mounting bolts</p>	1 - 43mm	G1/4	0.10	P2N-AA5B
	2 - 56mm	G3/8	0.15	P2N-BA5B
	3 - 71mm	G1/2	0.20	P2N-CA5B

 Indicates stocked product.

Side ported subbases

Description	Size	Port size	Weight kg	Order code BSP	Order code NPT
 Single subbase with side ports 1 3 5 2 4 ports & 12 14	1 - 43mm	G1/4	0.16	PL1-1/4-70	PL1-1/4-80
	1 - 43mm	G3/8	0.16	PL1-3/8-70	
	2 - 56mm	G3/8	0.28	PL2-3/8-70	PL2-3/8-80
	2 - 56mm	G1/2		P2N-HS514SS	
	3 - 71mm	G1/2		PL3-1/2-70	PL3-1/2-80
	3 - 71mm	G3/4		P2N-JS516SD	



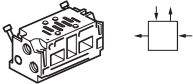
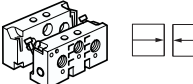

Bottom ported subbases

Description	Size	Port size	Weight kg	Order code BSP	Order code NPT
 Single subbase with bottom ports 1 3 5 2 4 ports & 12 14	1 - 43mm	G1/4	0.37	PD1-1/4-70	PD1-1/4-80
	2 - 56mm	G3/8	0.59	PD2-3/8-70	PD2-3/8-80
	3 - 71mm	G1/2	0.59	PD3-1/2-70	

Sizes 1 & 2 side ported manifold

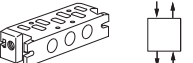
Description	Size	Port size	Weight kg	Order code
 Manifold Manifold with side port	1 - 43mm	G1/4	0.24	P2N-EM512MD
	2 - 56mm	G3/8	0.21	P2N-FM513MD
 End Side ported connecting kit for above manifold with side ports	1 - 43mm	G3/8	0.36	P2N-EM513ES
	2 - 56mm	G1/2	0.29	P2N-FM514ES

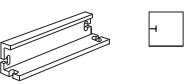
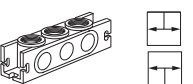
Size 1 bottom ported manifold

Description	Size	Port size	Weight kg	Order code
 Manifold with bottom ports low profile	1 - 43mm	G1/4	0.20	P2N-AM512MB
	 Connecting block Top or bottom ported connecting block for above manifold "low profile"	1 - 43mm	G3/8	0.15
 End End piece for above manifold "low profile"		1 - 43mm	no	0.06
	 Intermediate supply Top or bottom ported intermediate supply for above manifold "low profile"	1 - 43mm	G3/8	0.14
 Isolation plugs Isolating seal for above manifold "low profile"		1 - 43mm		0.07
	For use with 2 different pressures			

 Indicates stocked product.

22 mm and CNOMO Solenoid pilot

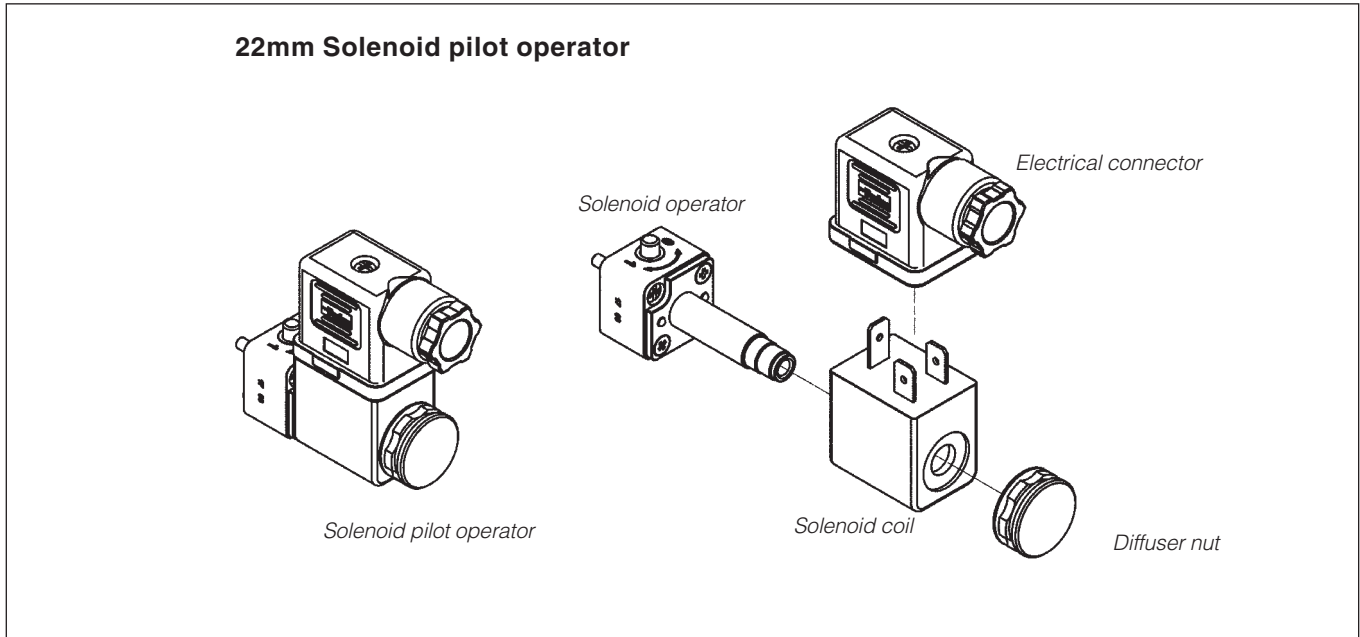

22 mm and CNOMO Solenoid pilot

3/2 solenoid pilot operators are designed for piloting pneumatic control valves with compressed air or other inert gases. The P2F P operator is available for Normal operating pressures up to 10 bar having an outlet orifice 1.3mm and exhaust orifice 1.5 mm.

Corrosion resistant design

The pilot operator body is manufactured in thermoplastic PA 6 material and the core tube brass/stainless steel. The plunger/core is made from stainless steel and the valve seats from FKM.

Solenoid Pilot Exhaust

These operators all exhaust out of the top of the core tube which is tapped M5. The standard solenoid nut fitted to the core tube is the Diffuser nut which allows the exhaust to escape to atmosphere. This nut also minimises ingress of dirt into the valve through this port. The alternative plastic knurled nut can be specified (refer to part number system) if the exhaust air needs to be captured and piped away using the M5 tapped port.

Coils

Coils are wound with enameled copper wire, having temperature index 180°C with class F insulation (155°C) and are encapsulated in Thermoplastic resin. When fitted with suitable connector and correct gasket they give protection to IP65.

Manual Override options

The pilot operators can be supplied with or without manual override. The standard manual override is the monostable (spring return) extended brass override. Alternatively the bistable (locking) override can be specified as an alternative for the Normal duty 10 bar option.

Spares

Solenoid operators are available as spares complete with mounting screws and seals. Coils and connectors should be ordered separately.

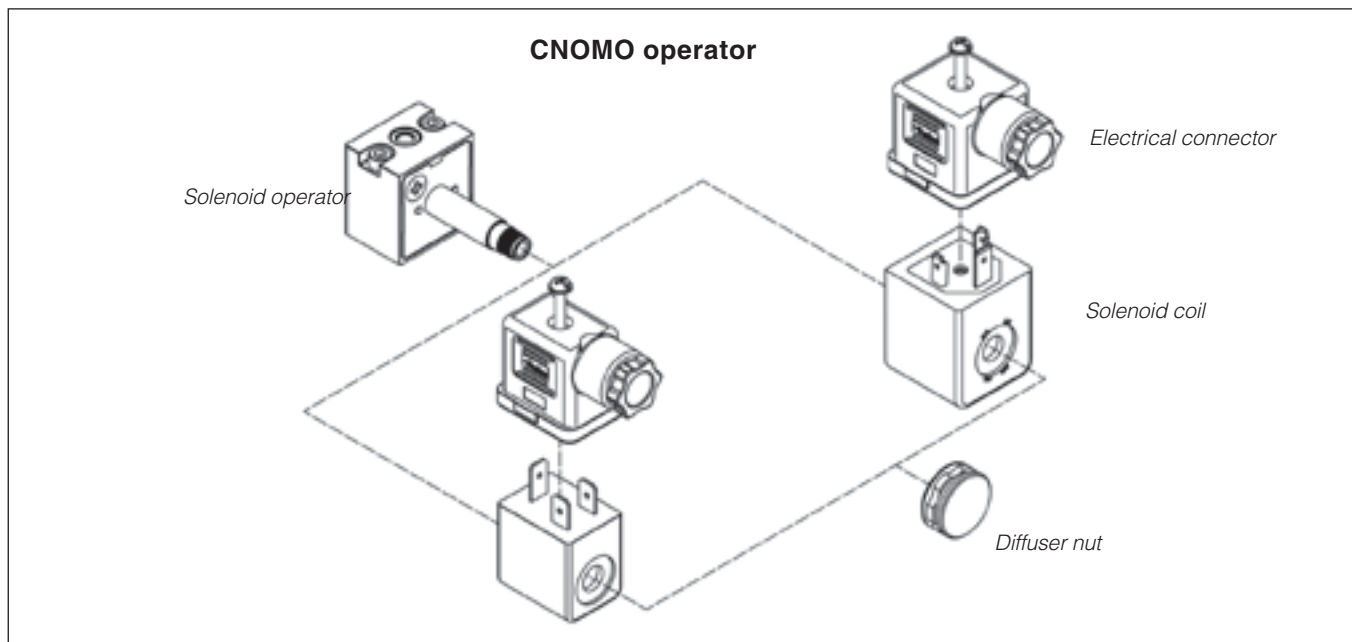

Common technical data

	NC 22 mm operator with 20 x 30 standard coil	NC CNOMO operator with 30 x 30 standard coil	NC CNOMO operator with 22 x 30 standard coil
Working pressure	0 to 10 bar	0 to 10 bar	0 to 10 bar
Ambient temperature	-10 °C to +50 °C	-10 °C to +60 °C (1)	-10 °C to +60 °C (1)
Port	1.3/1.5mm	1.3/1.5mm	1.3/1.5mm
Flow Qn at 6 bar input 1 bar press drop. 1-2 l/m	55	50	50
Flow Qn at 6 bar input 1 bar press drop. 2-3 l/m	70	70	70
Power, hold (DC)	4.8W	2.7W	4.8W
Power, surge (AC)	8.5VA	4.9VA	8.5VA
Voltage tolerance (Standard)	+/- 10%	+/- 10%	+/- 10%
Duty cycle	100%	100%	100%
Insulation class	F	F	F
Electric connection	Industrial	Din A	Industrial
Protection	IP65	IP65	IP65
Shock & Vibration	-	1g	1g
Approval	CSA/UL	CSA/UL (optional)	-
Working media	All neutral media such as compressed air and inert gases.		

(1) limited to 50°C if use with 100% duty cycle

Transients

Interrupting the current through the solenoid coil produces momentary voltage peaks which, under unfavourable conditions, can amount to several hundred times the rated operating voltage. Normally, these transients do not cause problems, but to achieve the maximum life of relays in the circuit (and particularly of transistors, thyristors and integrated circuits) it is desirable to provide protection by means of voltage-dependent resistors (varistors). All connectors/cable plugs with LED's listed on page 34 include this type of circuit protection.

Materials

Pilot Valve

Body	Polyamide
Armature tube	Brass
Plunger & core	Corrosion resistant Cr-Ni steel
Seals	FKM (Viton™)
Screws	Stainless steel

Coil

Encapsulation material	Thermoplastic
------------------------	---------------

Solenoid coils with Din A or Industrial connection

Voltage	Order code Din A 30 x 30	Weight (kg) Standard	Order code Din A 30 x 30	Weight (kg) Mobile	Order code Industrial standard 22 x 30	Weight (kg)
Direct current						
12V DC	P2FCA445	0.105	P2FCA447	0.105	P2FCB445	0.093
24V DC	P2FCA449	0.105	P2FCA448	0.105	P2FCB449	0.093
48V DC	P2FCA453*	0.105	P2FCA474	0.105	P2FCB451	0.093
72V DC			P2FCA470	0.105		
96V DC			P2FCA471	0.105		
110V DC			P2FCA472	0.105		
Alternative current						
12V 50/60Hz	P2FCA440	0.105			P2FCB440	0.093
24V 50/60Hz	P2FCA442	0.105			P2FCB442	0.093
48V 50/60Hz	P2FCA469#	0.105				
110V 50Hz, 120V 60Hz	P2FCA453	0.105			P2FCB453	0.093
230V 50Hz, 230V 60Hz	P2FCA457	0.105			P2FCB457	0.093

* P2FCA453 is compatible with 110 V AC and 48 V DC

P2FCA469 is 24 V DC 6.8W or 48 V 50Hz 9.9 VA

Solenoid coils with M12 connection

Voltage	Order code 30 x 30	Weight (kg)	Order code 22 x 30	Weight (kg)
Direct current				
24V DC	P2FC6419	0.065	P2FC7419	0.065

Spare Solenoid Nuts

Valves requiring captured exhaust should be fitted with plastic knurled nut

Order code
P2FNP

Valves with vented exhaust are fitted with diffuser plastic nut

Order code
P2FND

Spare Solenoid Operators

Solenoid pilot operator NC

Description	Order code No manual override	Weight (kg)	Order code Non-lock manual override	Weight (kg)	Order code Locking manual override	Weight (kg)
22 mm			P2FP13N4D		P2FP13N4C	
CNOMO	P2FP23N4A	0.065	P2FP23N4B	0.065	P2FP23N4C	0.065

Note.



Solenoid pilot operators are fitted to the valve range. Order the above part numbers for spares. The operators are supplied with mounting screws and interface 'O' rings.

Coils and connectors must be ordered separately.

 Indicates stocked product.

Connectors

Solenoid Connectors / Cable Plugs EN175301-803

	Description	Order code 15mm Form C/ISO15217	Order code 22mm Industrial Form B	Order code 30mm Form A/ISO4400
With large headed screw suitable for mounting in inaccessible or recess position 	Standard IP65 without cable	P8C-C		
	24V DC LED and protection IP65	P8C-C26C		
	110V AC LED and protection IP65	P8C-C21E		
With standard screw 	Standard IP65 without flying lead	P8C-D	3EV10V10	3EV290V10
	With LED and protection 24V AC/DC	P8C-D26C	3EV10V20-24	3EV290V20-24
	With LED and protection 110V AC	P8C-D21E	3EV10V20-110	3EV290V20-110
	With LED and protection 230V AC		3EV10V20-230	3EV290V20-230
With cable 	Standard with 2m cable IP65	P8L-C2		
	Standard with 5m cable IP65	P8L-C5		
	24V AC/DC, 2m cable LED and protection IP65	P8L-C226C		
	24V AC/DC, 5m cable LED and protection IP65	P8L-C526C	3EV10V20-24L5	3EV290V20-24L5
	24V AC/DC, 10m cable LED and protection IP65	P8L-CA26C		
	110V AC/DC, 2m cable LED and protection IP65	P8L-C221E		
	110V AC/DC, 5m cable LED and protection IP65	P8L-C521E	3EV10V20-110L5	3EV290V20-110L5
	230V AC, 5m cable LED and protection IP65		3EV10V20-230L5	3EV290V20-230L5

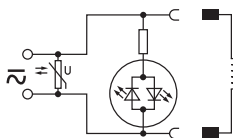
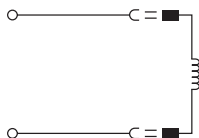

P8C-C
P8C-D
P8L-C2
P8L-C5
3EV10V10
3EV290V10

P8C-D26C	P8L-C226C
P8C-D21E	P8L-C526C
P8C-C26C	P8L-CA26C
P8C-C21E	P8L-C221E
	P8L-C521E
3EV10V20-24	3EV10V20-24L5
3EV10V20-110	3EV10V20-110L5
3EV10V20-230	3EV10V20-230L5

 Indicates stocked product.

Dimensions (mm)

Cable Plug Dimensions

Solenoid operators P2F - CNOMO - 22 x 30mm



Cable plugs Form C

P8L-C2
P8L-C5
P8L-C226C
P8L-C526C
P8L-CA26C
P8L-C221E
P8L-C521E

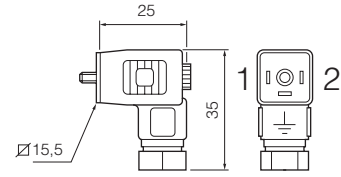

Cable plugs Form C with moulded cable

P8C-C
P8C-C26C
P8C-C21E
P8C-D
P8C-D26C
P8C-D21E

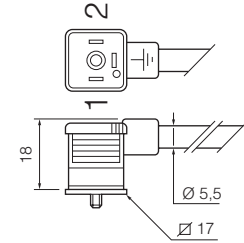

Cable plugs Form B

3EV10V10
3EV10V20-110
3EV10V20-230

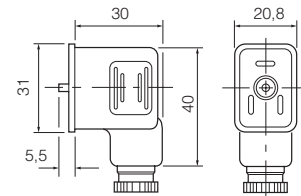

Cable plugs Form A

3EV290V10
3EV290V20-24

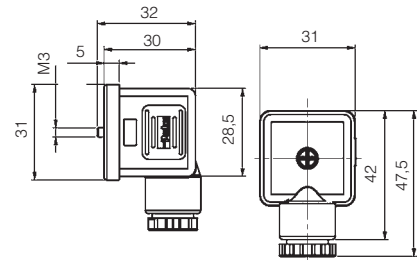

Accessories

Silencers

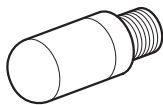

Port	Order code	Pack Qty
G1/8	P6M-PAB1	10
G1/4	P6M-PAB2	10
G3/8	P6M-PAB3	10
G1/2	P6M-PAB4	10

Fittings

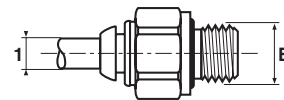

Male connector - BSPP

Tube dia 1	Thread B	Order code	Box Qty
4	1/8	F4PMB4-1/8	20
4	1/8	F4PMB4-1/8	20
6	1/8	F4PMB6-1/8	30
8	1/8	F4PB8-1/8	40
6	1/4	F4PMB6-1/4	30
8	1/4	F4PB8-1/4	30
10	1/4	F4PB10-1/4	20
12	1/4	F4PB12-1/4	10
8	3/8	F4PB8-3/8	20
10	3/8	F4PB10-3/8	20
12	3/8	F4PB12-3/8	10
14	3/8	F4PB14-3/8	10
10	1/2	F4PB10-1/2	10
12	1/2	F4PB12-1/2	10
14	1/2	F4PB14-1/2	10

 Indicates stocked product.

VG25-AA

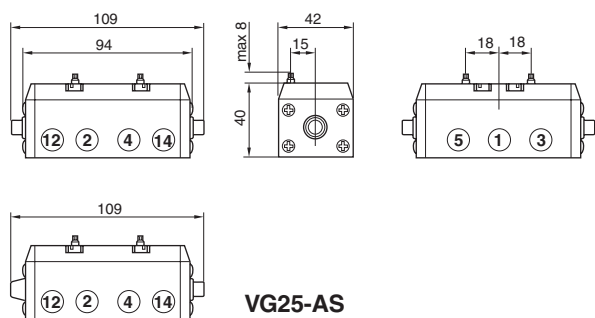

VG25-AS

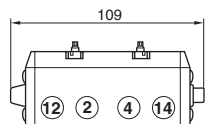

VG25-AC, VG25-XAC, VG25-YAC

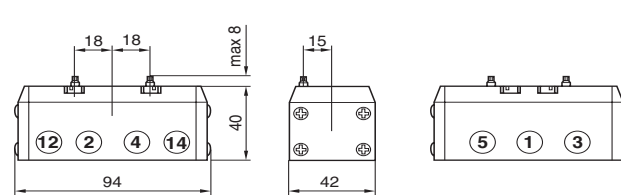

VG25-ERER, VG25-EAEA

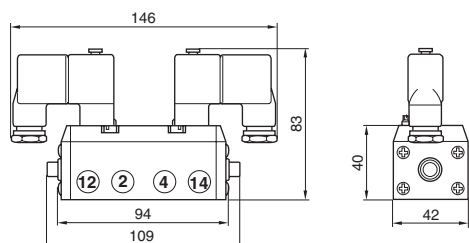

VG25-RER, VG25-AEA with CNOMO

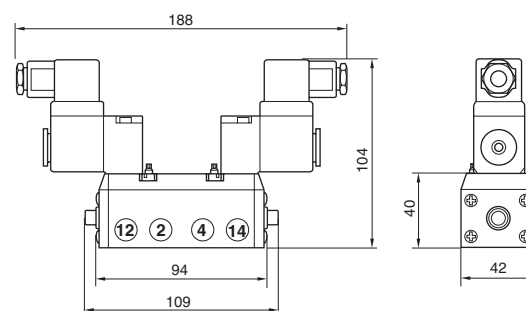

VG25-ERS, VG25-EAS

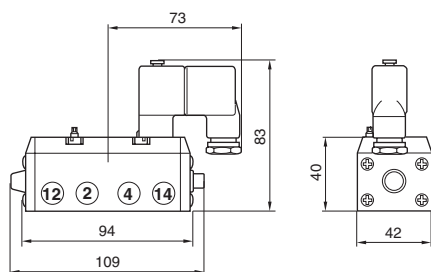

VG25-ERS, VG25-EAS with CNOMO

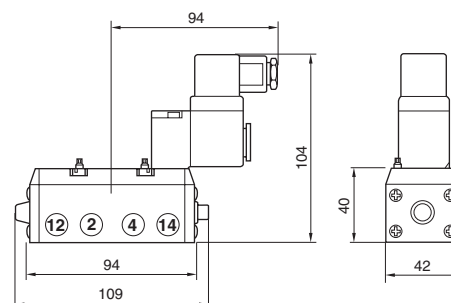

VG25-(X,Y)ERC, VG25-(X)EAC

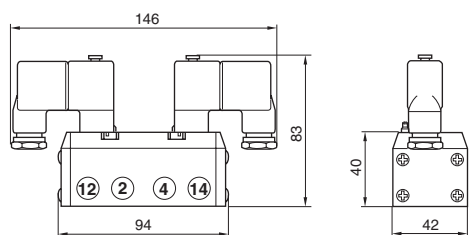

VG25-A(X)ERC, VG25-(X)EAC with CNOMO

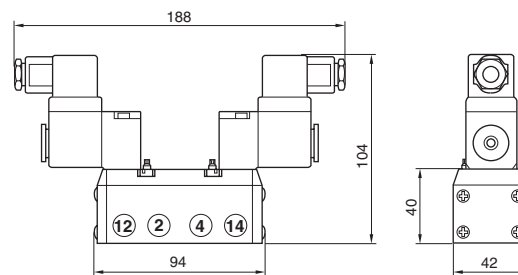

**VG35-AA
VG35-AC, VG35-XAC, VG35-YAC**

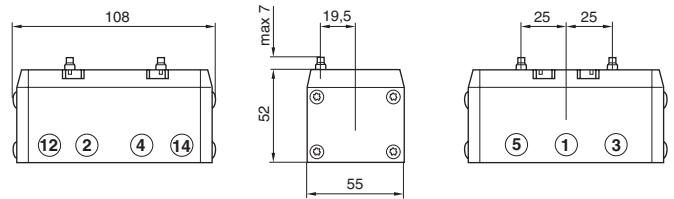
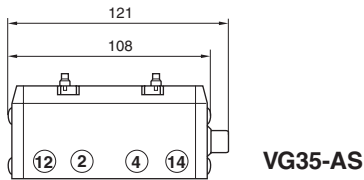
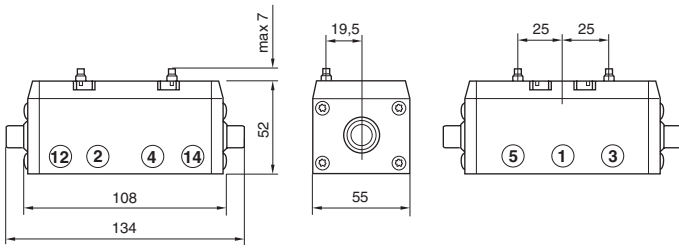

VG35-ERER, VG35-EAEA

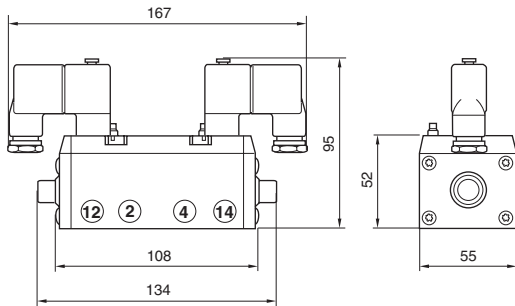

VG35-RER, VG35-AEA with CNOMO

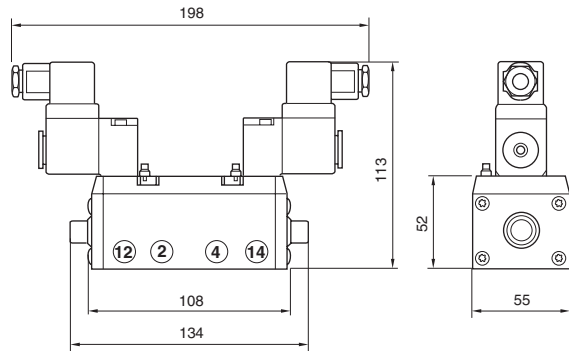

VG35-ERS, VG35-ERDR, VG35-EAS

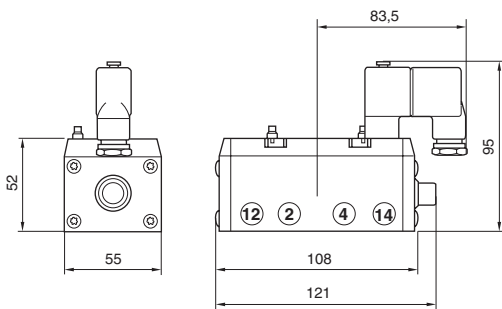

VG35-ERS, VG35-EAS with CNOMO

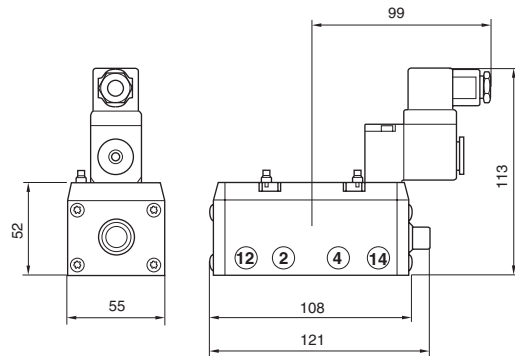

VG35-(X,Y)ERC, VG35-(X)EAC

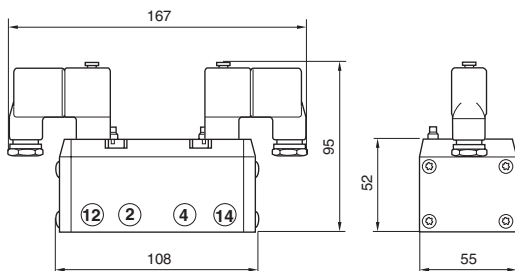

VG35-(X)ERC, VG35-EAC with CNOMO

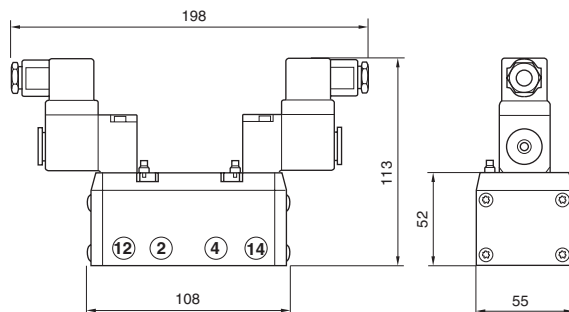

VG45-AA
VG45-AC, VG45-XAC

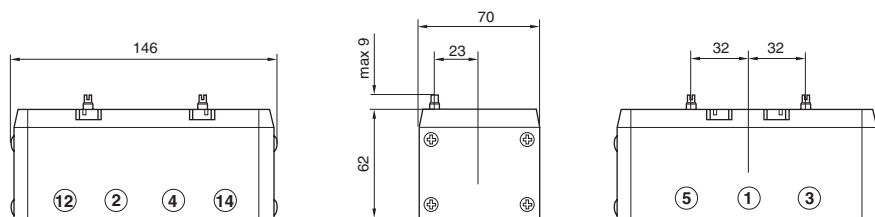
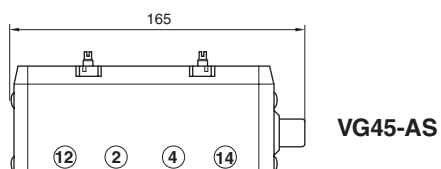
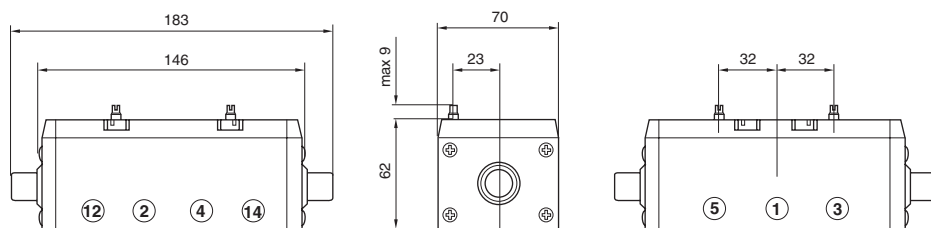

VG45-ERER, VG45-EAEA

VG45-ERS, VG45-EAS

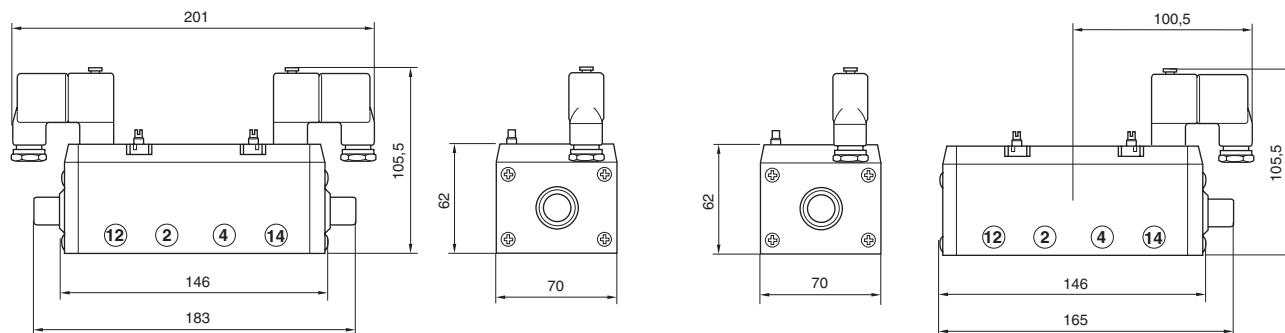

VG45-ERC, VG45-XERC

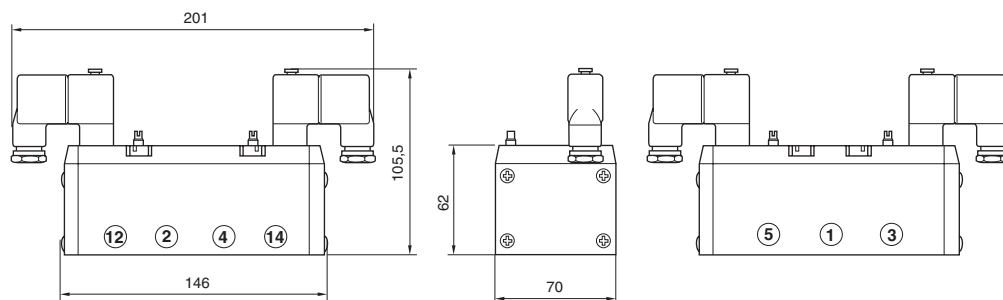

Dimensions (mm)

Single subbase with side ports according to VDMA

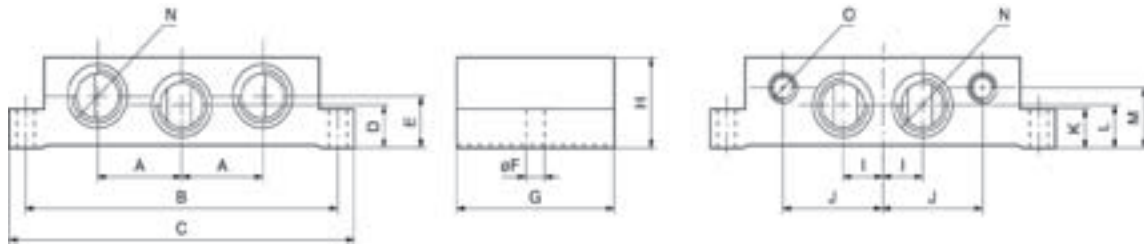

Order code	Size ISO	Port Size	A	B	C	D	E	F	G	H	I	J	K	L	M	N	O
P2N-VS512SD	1	G1/4	21,5	98	110	11	20	5,5	48	32	12	29	10	11	23	G1/4	G1/8
P2N-WS513S	2	G3/8	28	112	124	14	26	6,6	56	40	15	37	13	14	30	G3/8	G1/8
P2N-YS514SD	3	G1/2	34	136	149	17	17	6,6	71	32	16	45	18	17	22	G1/2	G1/8

Single subbase with side ports

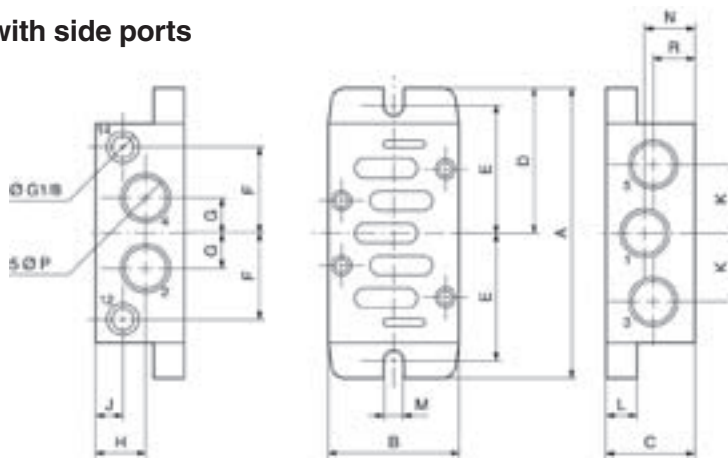

Order code	ISO Size	ØP	A	B	C	D	E	F	G	H	J	K	L	M	N	R
PL1-1/4-70	1	G1/4	110	46	29	55	49	30	11	17,75	17,75	22	6	5,5	17,75	17,75
PL2-3/8-70	2	G3/8	124	56	37	62	55	37	14,5	22,5	14	28	6	5,5	22,5	14,5
P2N-JS516SD	3	G3/4	149	71	60	74,5	68	45	21	33	10	40	18	6,6	37,5	22,5

Single subbase with bottom ports

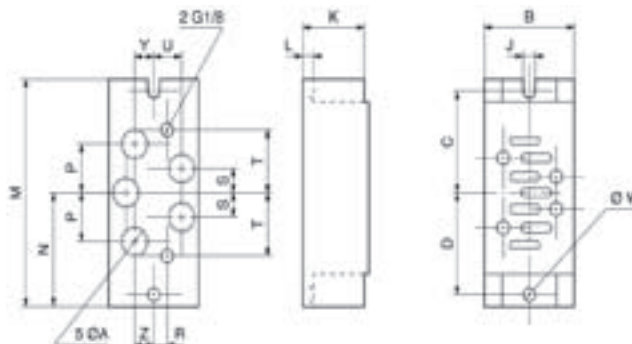

Order code	A	B	C	D	J	K	L	M	N	P	R	S	T	U	W	Y	Z
PD1-1/4-70	G1/4	46	49	49	5,5	29	6	110	55	22	10	11	30	10	5,5	10	10
PD2-3/8-70	G3/8	56	55	55	5,5	37	6	124	62	29	10	14,5	37	12,5	5,5	12,5	12,5
PD3-1/2-70	G1/2	77	68	68	6,6	32	18	149	74,5	34	10	17	45	17	6,5	17	17

Dimensions (mm)

Manifold and end plates according to VDMA (P2N-VM / WM / YM)

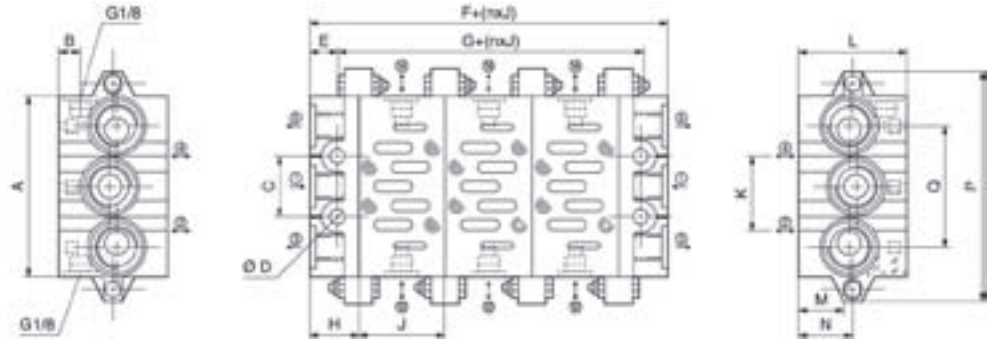

ISO Size	Port 1, 3, 5	Port 2, 4	A	B	C	D	E	F	G	H	J	K	L	M	N	O	P
1	G3/8	G1/4	85	8,5	28	7	11	44	22	22	43	26	46	21	24	56	110
2	G1/2	G3/8	100	9	35	9	13	52	26	26	56	30	47	22	24	68	135
3	G1	G1/2	140	10	52	12	15	60	30	30	71	38	56	31	34	104	190

Manifold and end plates with side ports (P2N-EM / FM..)

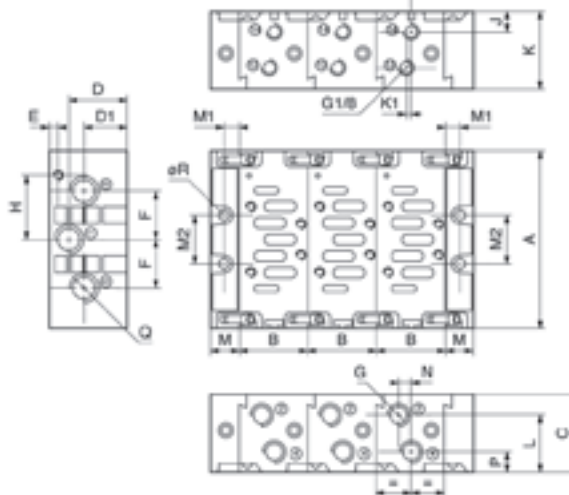

Order code	A	B	C	D	D1	E	F	G	H	J	K	K1	L	M	M1	M2	N	P	Q	R
P2N-EM ...	110	43	48	35,5	26,5	5,5	28	G1/4	36	15,5	35	3	32	20	11	28	12	12,5	G3/8	6
P2N-FM ...	129	56	60	44,5	35,5	6	34,5	G3/8	45	16	41,5	3	41	24	13	35	12,5	16	G1/2	8

Manifold and end plates with bottom ports "low profile" (P2N-AM..)

Manifold P2N-AM512MB

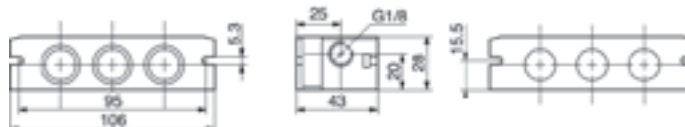

Connecting block P2N-AM513GT



End piece P2N-AM500J

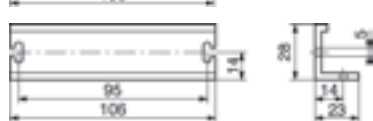

Intermediate supply P2N-AM513BT

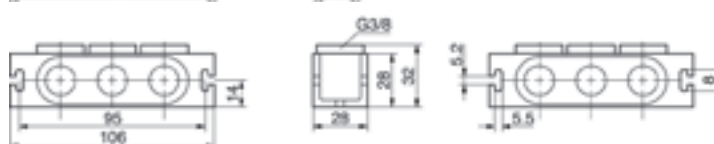

www.parker.com

Pneumatic Division Sales Offices

Austria - Wr.Neustadt

Tel: +43 2622 23501
Fax: +43 2622 66212

Belgium - Nivelles

Tel: +32 67 280 900
Fax: +32 67 280 999

**Czech & Slovak
Republics - Klecany**

Tel: +420 284 083 111
Fax: +420 2 4 083 112

Denmark - Ballerup

Tel: +45 43 560400
Fax: +45 43 733107

Finland - Vantaa

Tel: +358 9 4767 31
Fax: +358 9 4767 3200

France - Contamine

Tel : +33 4 50 25 80 25
Fax : +33 4 50 25 24 25

Germany - Kaarst

Tel: +49 2131 4016-0
Fax: +49 2131 4016-9199

Greece - Athens

Tel: +30 210 933 6450
Fax: +30 210 933 6451

Hungary - Budapest

Tel: +36 1 220 4155
Fax: +36 1 422 1525

Ireland - Dublin

Tel: +353 1 4666370
Fax: +353 1 4666376

Italy - Corsico, Milan

Tel: +39 02 4519 21
Fax: +39 02 4479 340

Netherlands - Oldenzaal

Tel: +31 541 585000
Fax: +31 541 585459

Norway - Langhus

Tel: +47 6491 1000
Fax: +47 6491 1090

Poland - Warsaw

Tel: +48 22 573 24 00
Fax: +48 22 573 24 03

**Portugal - Leça da
Palmeira**

Tel: +351 22 999 7360
Fax: +351 22 996 1527

Romania - Bucharest

Tel: +40 21 252 1382
Fax: +40 21 252 3381

Russia - Moscow

Tel: +7 095 580 91 45
Fax: +7 095 580 91 46

Slovenia - Novo mesto

Tel: +386 7337 6650
Fax: +386 7337 6651

Spain - Madrid

Tel: +34 91 675 7300
Fax: +34 91 675 7711

Sweden - Spånga

Tel: +46 8 5979 50 00
Fax: +46 8 5979 51 20

Switzerland - Bolligen

Tel.: +41 31 917 18 50
Fax: +41 31 917 18 59

Turkey - Istanbul

Tel: +90 212 482 91 06
Fax: +90 212 482 91 10

UK - Cannock

Tel: +44 1543 456000
Fax: +44 1543 456001

Ukraine - Kiev

Tel: + 380 44 494 2731
Fax: + 380 44 494 2730



Parker Hannifin Ltd.

Pneumatic Division,
Walkmill Lane, Bridgtown,
Cannock, Staffs. WS11 0LR
United Kingdom

We reserve the right to make
alterations without prior notification.

© Copyright 2007
Parker Hannifin Corporation

www.comoso.com