

**General Description**

Series D4S seat valves are designed for directional control functions. A large variety of poppets, springs and covers - including shuttle valves, stroke limiters, solenoid valves (VV01) and position control - allow to design individual hydraulic solutions for nominal flow up to 600 LPM (158.7 GPM).

A complete program is offered under the Parker brand: subplate mounted valves (D4S), SAE flange valves (D5S), pipe mounted valves (D4S), slip-in cartridges (CAR - on request).

**Features**

- Subplate mounting acc. to ISO 5781.
- Leak-free seat valve design.
- Numerous pilot options.
- 6 poppet types.
- 3 sizes (NG10, 25, 32).

**Performance Curves**

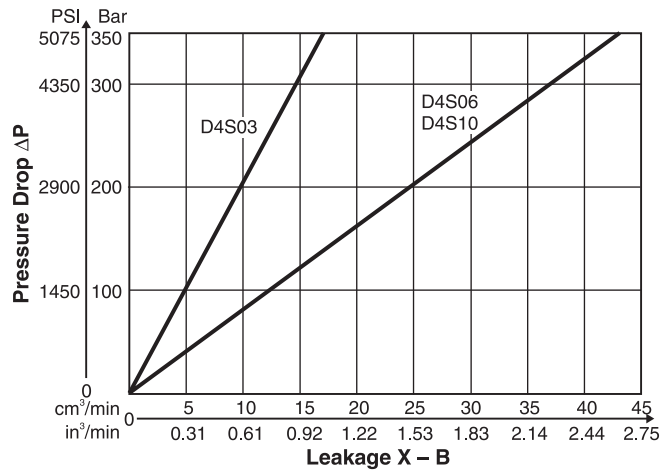
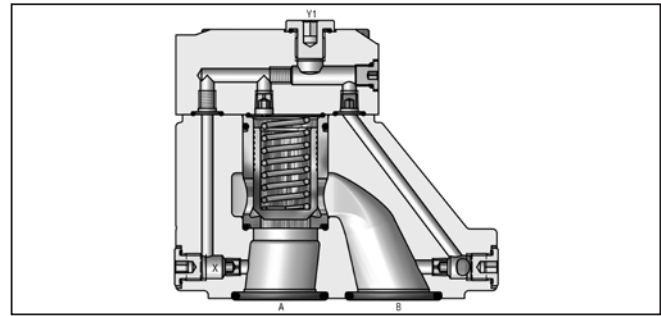
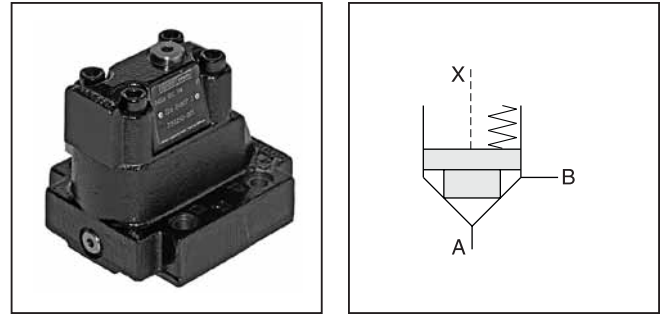
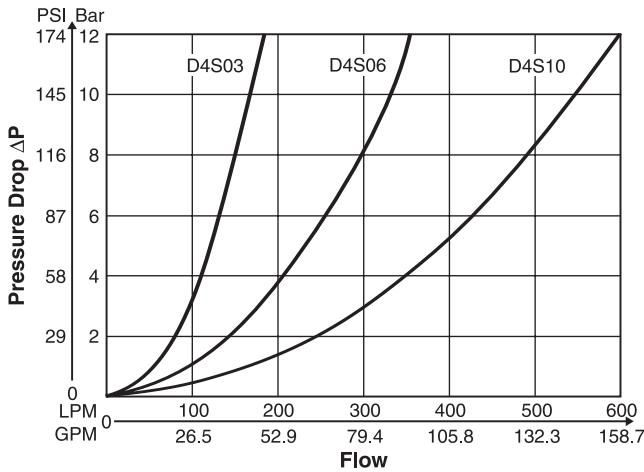

All characteristic curves measured with HLP46 at 50°C.

**Selection of Cartridges**

Sleeve 1, Poppet 1	Sleeve 1, Poppet 2	Sleeve 1, Poppet 4	Sleeve 3, Poppet 4	Sleeve 3, Poppet A	Sleeve 3, Poppet B/C
1 : 1.05 $A_A = 0.95 A_C$ $A_B = 0.05 A_C$ 15° chamfer	1 : 1.05 $A_A = 0.95 A_C$ $A_B = 0.05 A_C$ 15° chamfer orifice	1 : 1.05 $A_A = 0.95 A_C$ $A_B = 0.05 A_C$ 45° chamfer	1 : 1.67 $A_A = 0.6 A_C$ $A_B = 0.4 A_C$ 45° chamfer	1 : 1.67 $A_A = 0.6 A_C$ $A_B = 0.4 A_C$ 45° chamfer safety spool	1 : 1.67 $A_A = 0.6 A_C$ $A_B = 0.4 A_C$ 45° chamfer throttle spool

D4S.indd, dd



**A**

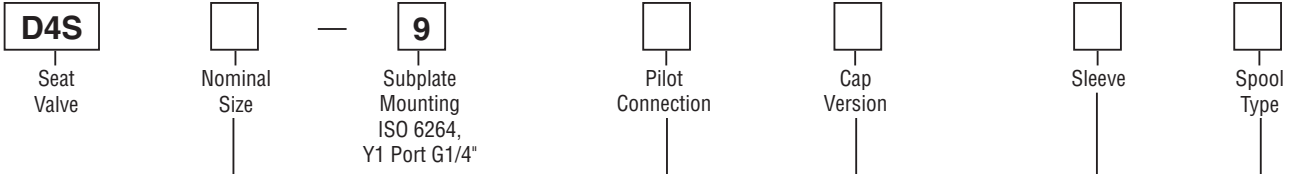

Code	Description
03	NG10
06	NG25
10	NG32

Code	Pilot Oil Line in Body	A-X B-Y	
		A-X	B-Y
1	Internal from A	○	○
2	External from X	●	○
A <sup>1)</sup>	Internal from A	○	○
B <sup>1)</sup>	External from X	●	○
C	Internal from A + B	○	○
D	Internal from B	●	○
G	External from Y	●	●

<sup>1)</sup> With VV01 only.

Code	Description
1	AA=95%, AB=5%
3	AA=60%, AB=40%

Code	Ports	X	Y	Z	X-Y	Y1	VV01
<b>Standard</b>							
1	Pilot Oil = Pilot Drain	○	●	○	○	○	—
C	Pilot Oil = Pilot Drain	●	○	○	○	○	—
<b>With Solenoid Valve (VV01)</b>							
2	External PD from cap	○	○	○	●	○	●
5	External to subplate	○	○	○	●	○	○
6	Internal pilot drain	○	○	○	○	○	○
<b>With Stroke Limiter (not for D4S03)</b>							
3	Pilot Oil = Pilot Drain	○	●	—	—	—	—
4	Pilot Oil = Pilot Drain	●	○	—	—	—	—

**Key:** ○ Open Bore   ● Closed Bore   ○ Orifice Ø 1.2  
**Note:** Combination examples provided on pages A227-A229.

Code	Size	Poppet Type	Sleeve
1	03, 06, 10	With closed bottom and 15° chamfer (pZ max. = pA +20 Bar (290 PSI))	1
2	03	With 0.8 dia. orifice at the bottom and 15° chamfer	1
	06, 10	With 1.2 dia. orifice at the bottom and 15° chamfer	1
4	03, 06, 10	With closed bottom and 45° chamfer	1, 3
A*	06, 10	Safety spool (for end position control only)	3
B*	06, 10	Throttle spool, 10° chamfer	3
C*	06, 10	Throttle spool, 3° chamfer	3

\* Springs 2, 3 and 6 only.



Spring

Switching Type

Solenoid Voltage

Design Series

Seal

Options

Code	Description
Omit	Standard w/o vent function
G0R	12V
G0Q	24V
GAR	98V
GAG	205V
W30	110V 50Hz / 120V 60Hz
W31	230V 50Hz / 240V 60Hz

Code	Description
1	Nitrile
5	Fluorocarbon

Code	Description
Omit	Standard
013	Cover for End Position Control

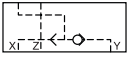
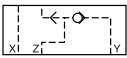
Code	Description	
Omit	Standard without Vent Function	
09	VV01 with Manual Override	De-energized; power comp. open
10	VV01 without Manual Override	De-energized; power comp. closed
11	VV01 with Manual Override	De-energized; power comp. open
12	VV01 without Manual Override	De-energized; power comp. closed
CA	Shuttle Valve	
DA	Shuttle Valve	
CB	VV01 Code 09 and Shuttle Valve Code CA	
CD	VV01 Code 11 and Shuttle Valve Code CA	
DB	VV01 Code 09 and Shuttle Valve Code DA	
DD	VV01 Code 11 and Shuttle Valve Code DA	
BH	VV01 Code 10 and Shuttle Valve Code CA and Position Control* with Amplifier	
BK	VV01 Code 12 and Shuttle Valve Code CA and Position Control* with Amplifier	
BN	VV01 Code 10 and Shuttle Valve Code DA and Position Control* with Amplifier	
BQ	VV01 Code 12 and Shuttle Valve Code DA and Position Control* with Amplifier	
BC	VV01 Code 10 and Position Control* with Amplifier	
BE	VV01 Code 12 and Position Control* with Amplifier	
BA	Position Control* with Amplifier	
BF	Position Control* with Amplifier and Shuttle Valve Code CA	
BL	Position Control* with Amplifier and Shuttle Valve Code DA	

**Weight:**  
D4S03 2.7 kg (6.0 lbs)  
D4S06 4.5 kg (9.9 lbs)  
D4S10 6.0 kg (13.2 lbs)

\* Position control for D4S06/10 only.  
Spring 2 or 4. Spool A and sleeve 3.  
Valve open: Proximity Switch damped.

Code	Spring — Approx. Cracking Pressure in Bar (PSI)					
	Sleeve Code 1		Sleeve Code 3			
	A -> B		A -> B		B -> A	
	D4S03	D4S06/10	D4S03	D4S06/10	D4S03	D4S06/10
1	2.8 (40.6)	3.5 (50.8)	6.5 (94.3)	6.5 (94.3)	9.5 (137.8)	11.0 (159.5)
2	0.5 (7.3)	0.5 (7.3)	1.0 (14.5)	1.0 (14.5)	1.5 (21.8)	1.7 (24.7)
3	0.3 (4.4)	0.3 (4.4)	0.6 (8.7)	0.6 (8.7)	0.9 (13.1)	1.0 (14.5)
4	2.2 (31.9)	2.2 (31.9)	4.0 (58.0)	3.5 (50.8)	5.5 (79.8)	6.0 (87.0)
5	—	9.0 (130.5)	—	16.0 (232.0)	—	28.0 (406.0)
6	1.2 (17.4)	1.2 (17.4)	2.0 (29.0)	2.2 (31.9)	3.0 (43.5)	3.8 (55.1)
7	3.0 (43.5)	—	8.0 (116.0)	—	12.0 (174.0)	—

**Specifications**

**A**

General							
<b>Size</b>		<b>03</b>	<b>06</b>	<b>10</b>			
<b>Mounting</b>	Subplate according to ISO 6264						
<b>Mounting Position</b>	Unrestricted						
<b>Ambient Temperature Range</b>	-20°C to +50°C (-4°F to +122°F)						
<b>MTTF<sub>D</sub></b>	150 years						
Hydraulic							
<b>Maximum Operating Pressure</b>	<b>Ports A, B</b>	up to 350 Bar (5075 PSI)	up to 350 Bar (5075 PSI)	up to 350 Bar (5075 PSI)			
	<b>Port Y with VV01</b>	140 Bar (2030 PSI)	140 Bar (2030 PSI)	140 Bar (2030 PSI)			
<b>Nominal Flow</b>		180 LPM (47.6 GPM)	360 LPM (95.2 GPM)	600 LPM (158.7 GPM)			
<b>Fluid</b>	Hydraulic oil as per DIN 51524 ... 51525						
<b>Fluid Temperature</b>	-20°C to +80°C (-4°F to +176°F)						
<b>Viscosity</b>	<b>Permitted Recommended</b>	10 to 650 cSt / mm <sup>2</sup> /s (46 to 3013 SSU) 30 cSt / mm <sup>2</sup> /s (139 SSU)					
<b>Filtration</b>	ISO Class 4406 (1999) 18/16/13 (acc. NAS 1638: 7)						
Electrical (Solenoid)							
<b>Duty Ratio</b>	100%						
<b>Response Time</b>	Energized / De-energized AC 20/18 ms, DC 46/27 ms						
<b>Protection Class</b>	IP65 in accordance with EN60529 (plugged and mounted)						
	<b>Code</b>	<b>G0R</b>	<b>G0Q</b>	<b>GAR</b>	<b>GAG</b>	<b>W30</b>	<b>W31</b>
<b>Supply Voltage</b>		12V	24V	98V	205V	110V at 50Hz/ 120V at 60 Hz	220V at 50Hz/ 240V at 60Hz
<b>Tolerance Supply Voltage</b>		+5 to -10	+5 to -10	+5 to -10	+5 to -10	+5 to -10	+5 to -10
<b>Power Consumption, Hold</b>	[W]	31	31	31	31	78	78
<b>Power Consumption, In Rush</b>	[W]	31	31	31	31	264	264
<b>Max. Switching Frequency</b>	[1/h]	AC up to 7200; DC up to 16,000 switchings/hour					
<b>Solenoid Connection</b>	Connector as per EN175301-803						
<b>Protection Class</b>	IP65 in accordance with EN 60529 (plugged and mounted)						
<b>Coil Insulation Class</b>	H (180°C) (356°F)						

**D4S Pilot Configuration**

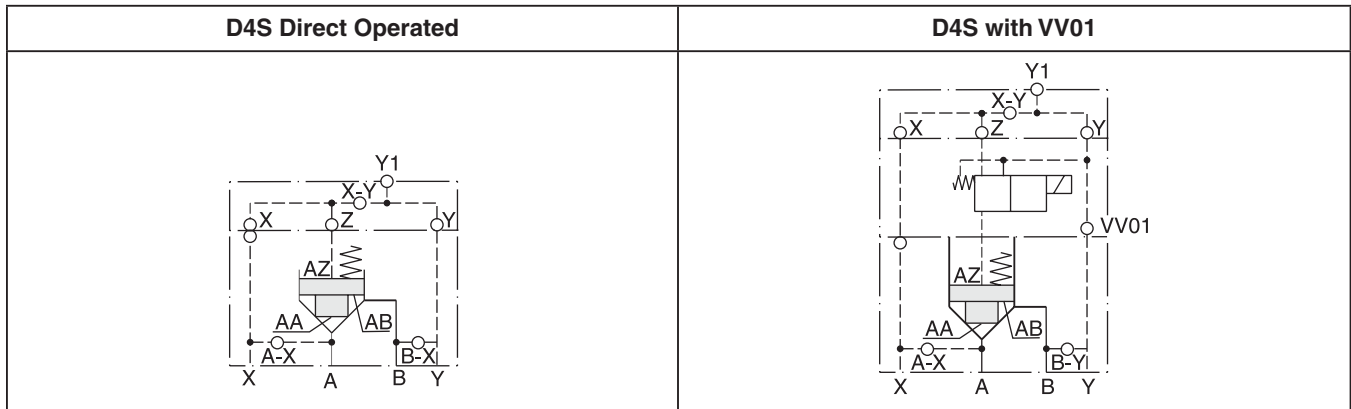



**D4S Direct Operated Examples**

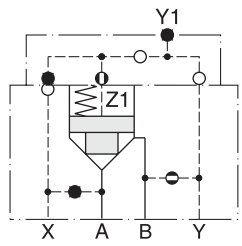

D4S...DC  
 Pilot oil Y = internal from B

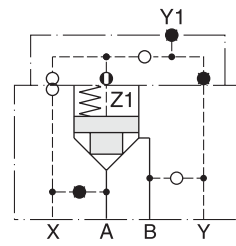

D4S...Z1  
 Pilot oil X = external

**D4S with VV01 Examples**

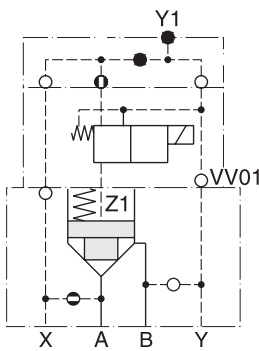

D4S...16...  
 09 } with VV01  
 10 }  
 11 }  
 12 }  
 Pilot oil X = internal from A  
 Drain Y = internal to B

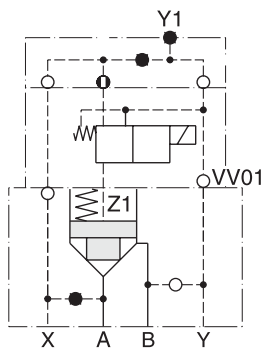

D4S...26...  
 09 } with VV01  
 10 }  
 11 }  
 12 }  
 Pilot oil X = external  
 Drain Y = internal to B

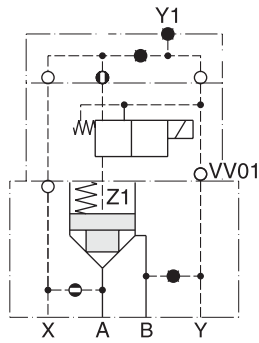

D4S...A5...  
 09 } with VV01  
 10 }  
 11 }  
 12 }  
 Pilot oil X = internal from A  
 Drain Y = external to subplate

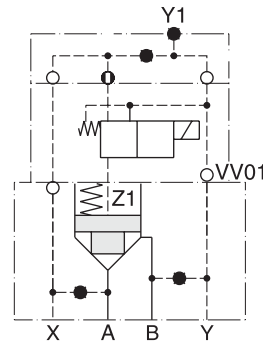

D4S...B5...  
 09 } with VV01  
 10 }  
 11 }  
 12 }  
 Pilot oil X = external  
 Drain Y = external to subplate

**D4S with VV01 Examples**

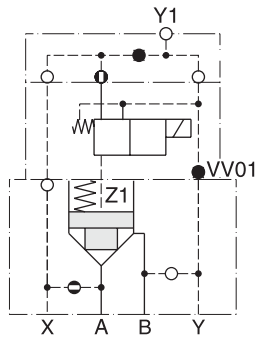

09 }  
 D4S...-12... 10 } with VV01  
 11 }  
 12 }

Pilot oil X = internal from A  
 Drain Y1 = external out of the cap

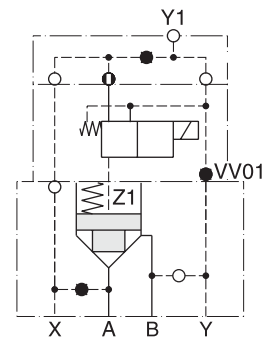

09 }  
 D4S...-22... 10 } with VV01  
 11 }  
 12 }

Pilot oil X = external  
 Drain Y1 = external out of the cap

**D4S with Shuttle Valve Examples**

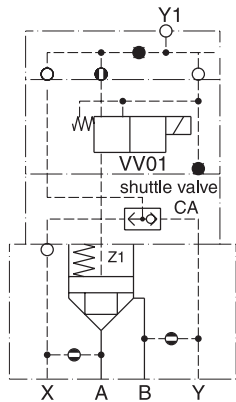

CB } with shuttle valve CA  
 D4S...-C2... CD } and VV01

Pilot oil = internal from A and B  
 Drain Y1 = external out of the cap

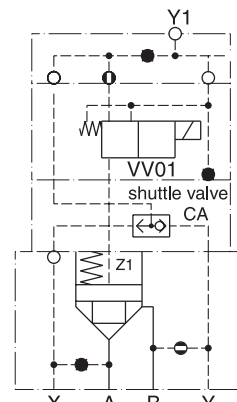

CB } with shuttle valve CA  
 D4S...-D2... CD } and VV01

Pilot oil = internal from B and  
 external from X  
 Drain Y1 = external out of the cap

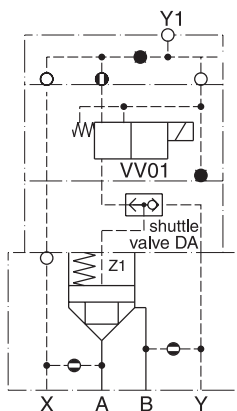

DB } with shuttle valve DA  
 D4S...-C2... DD } and VV01

Pilot oil = internal from A and B  
 (B-A = Check valve function)  
 Drain Y1 = external out of the cap

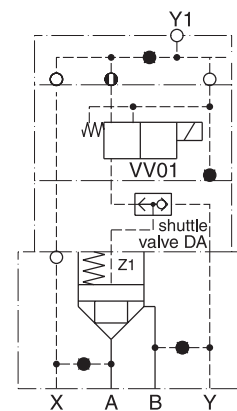

DB } with shuttle valve DA  
 D4S...-B2... DD } and VV01

Pilot oil = external from X and Y  
 Drain Y1 = external out of the cap

D4S.indd, dd



**D4S with Position Control Examples**

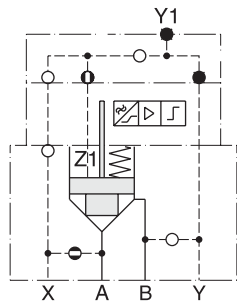

D4S.-.113A.BA  
 (with position control)

Pilot oil X = internal from A

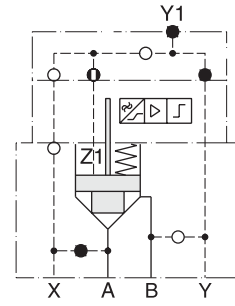

D4S.-.213A.BA  
 (with position control)

Pilot oil X = external

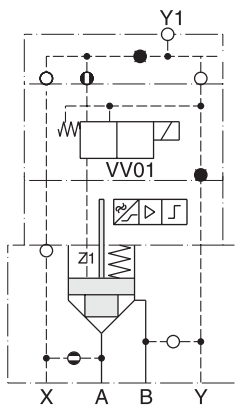

D4S.-.123A. BC } with position control  
 BE } and VV01

Pilot oil X = internal from A  
 Drain Y1 = external out of the cap

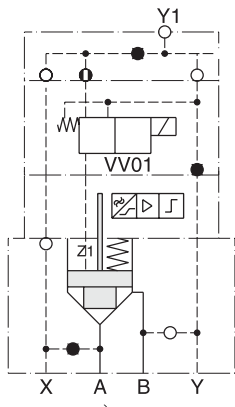

D4S.-.223A. BC } with position control  
 BE } and VV01

Pilot oil X = external  
 Drain Y1 = external out of the cap

**D4S with Stroke Limiter Examples**

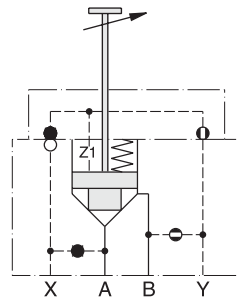

D4S.-.D434. with stroke limiter  
 Pilot oil Y = internal from B

Note: for D4S06 and D4S10 only

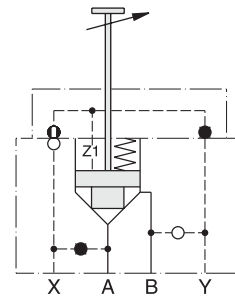

D4S.-.233B. with stroke limiter  
 Pilot oil X = external

Note: for D4S06 and D4S10 only

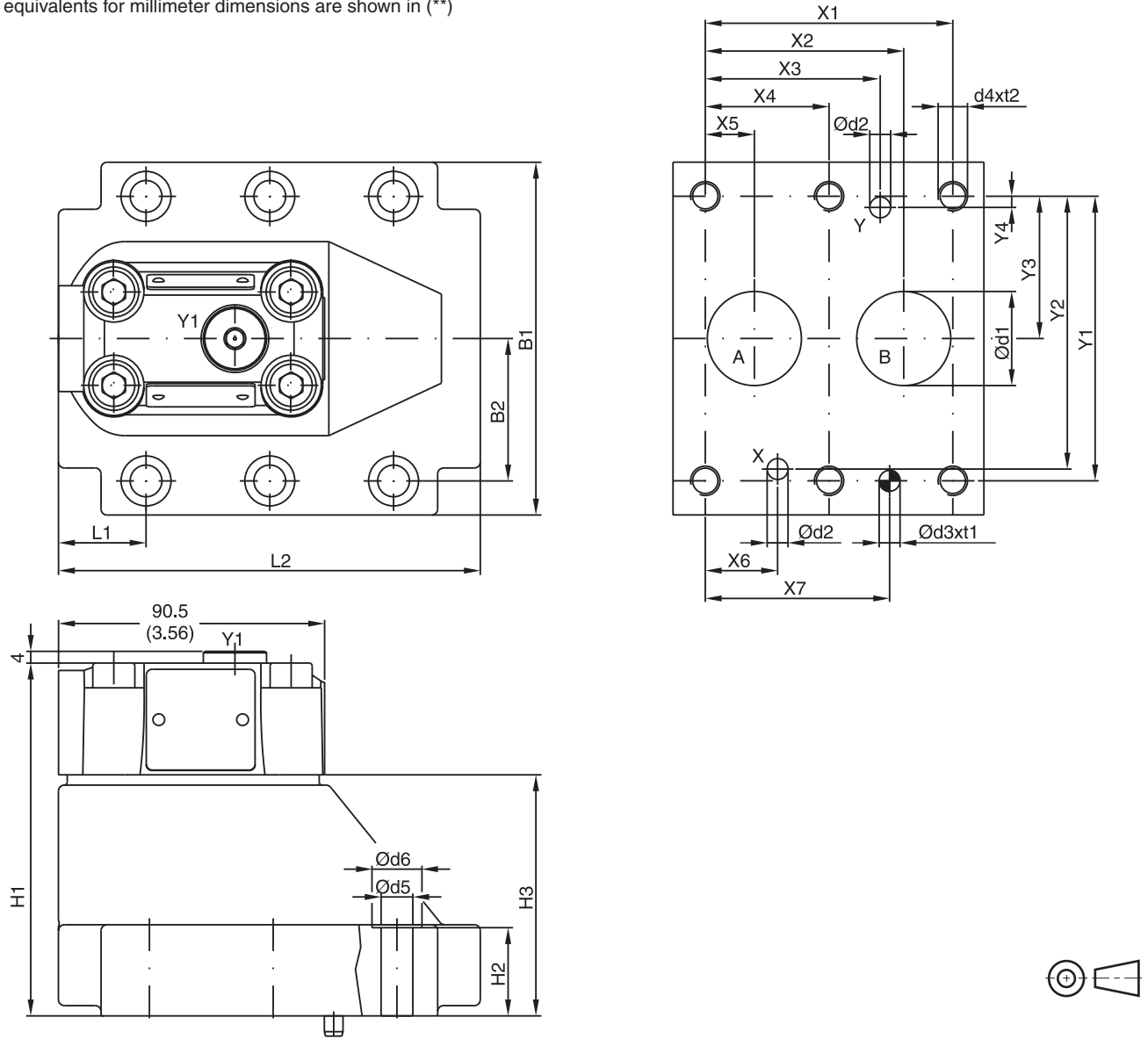

Inch equivalents for millimeter dimensions are shown in (\*\*)

**A**

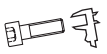

NG	ISO-code	X1	X2	X3	X4	X5	X6	X7	Y1	Y2	Y3	Y4
10	6264-06-09-*-97	42.9 (1.69)	35.8 (1.41)	21.5 (0.85)	-	7.2 (0.28)	21.5 (0.85)	31.8 (1.25)	66.7 (2.63)	58.8 (2.31)	33.4 (1.31)	7.9 (0.31)
25	6264-08-13-*-97	60.3 (2.37)	49.2 (1.94)	39.7 (1.56)	-	11.1 (0.44)	20.6 (0.81)	44.5 (1.75)	79.4 (3.13)	73.0 (2.87)	39.7 (1.56)	6.4 (0.25)
32	6264-10-17-*-97	84.2 (3.31)	67.5 (2.66)	59.5 (2.34)	42.1 (1.66)	16.7 (0.66)	24.6 (0.97)	62.7 (2.47)	96.8 (3.81)	92.8 (3.65)	48.4 (1.91)	3.8 (0.15)

NG	ISO-code	B1	B2	H1	H2	H3	L1	L2	D1	D2	D3	t1	D4	t2	D5	D6
10	6264-06-09-*-97	87.3 (3.44)	33.35 (1.31)	83.0 (3.27)	21.0 (0.83)	45.0 (1.77)	29.0 (1.14)	94.8 (3.73)	15.0 (0.59)	7.0 (0.28)	7.1 (0.28)	8.0 (0.31)	M10	16.0 (0.63)	10.8 (0.43)	17.0 (0.67)
25	6264-08-13-*-97	105.0 (4.13)	39.7 (1.56)	109.5 (4.31)	29.0 (1.14)	71.5 (2.81)	34.7 (1.37)	126.8 (4.99)	23.4 (0.92)	7.1 (0.28)	7.1 (0.28)	8.0 (0.31)	M10	18.0 (0.71)	110.8 (4.33)	17.0 (0.67)
32	6264-10-17-*-97	120.0 (4.72)	48.4 (1.91)	120.0 (4.72)	29.0 (1.14)	82.0 (3.23)	30.6 (1.20)	144.3 (5.68)	32.0 (1.26)	7.1 (0.28)	7.1 (0.28)	8.0 (0.31)	M10	20.0 (0.79)	10.8 (0.43)	17.0 (0.67)

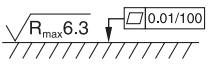
NG	ISO-code	Bolt Kit			Seal Kit	Surface Finish
					Nitrile / Fluorocarbon	
10	6264-06-07-*-97	BK 505	4x M10 x 35 DIN 912 12.9	63 Nm	S26-58507-0 / S26-58507-5	
25	6264-08-11-*-97	BK 485	4x M10 x 45 DIN 912 12.9	(46.5 lb.-ft.)	S26-58475-0 / S26-58475-5	
32	6264-10-15-*-97	BK 506	6x M10 x 45 DIN 912 12.9	±15%	S26-58508-0 / S26-58508-5	

D4S.indd, dd





Inch equivalents for millimeter dimensions are shown in (\*\*)

**D4S with VV01**

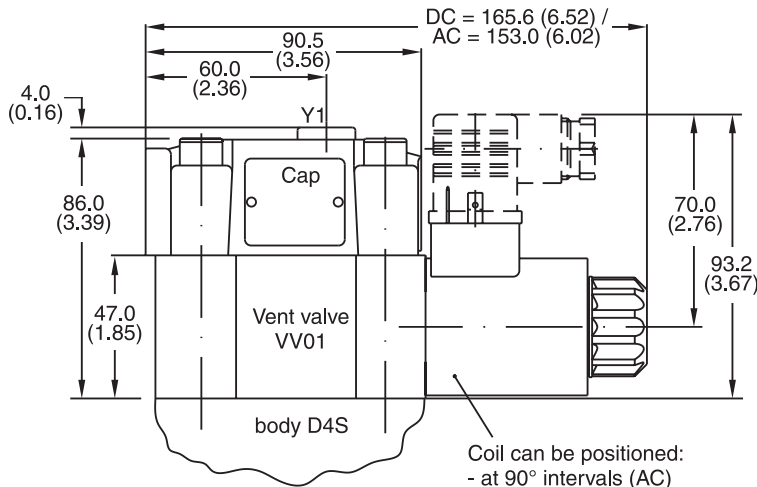

Coil can be positioned:  
- at 90° intervals (AC)  
- in any position (DC)

VV01 Seal Kits	
Nitrile	Fluorocarbon
DC Solenoid	
S26-58515-0	S26-58515-5
AC Solenoid	
S26-35237-0	S26-35237-5

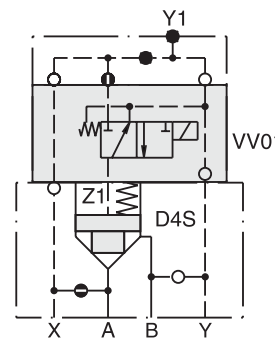

with manual override | without manual override

D4S.-..... 09/10  
Solenoid energized:  
D4S blocked  
Solenoid de-energized:  
Flow from A-B or B-A

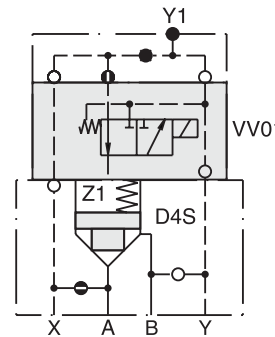

with manual override | without manual override

D4S.-..... 11/12  
Solenoid energized:  
Flow from A-B or B-A  
Solenoid de-energized:  
D4S Blocked

**D4S with Shuttle Valve**

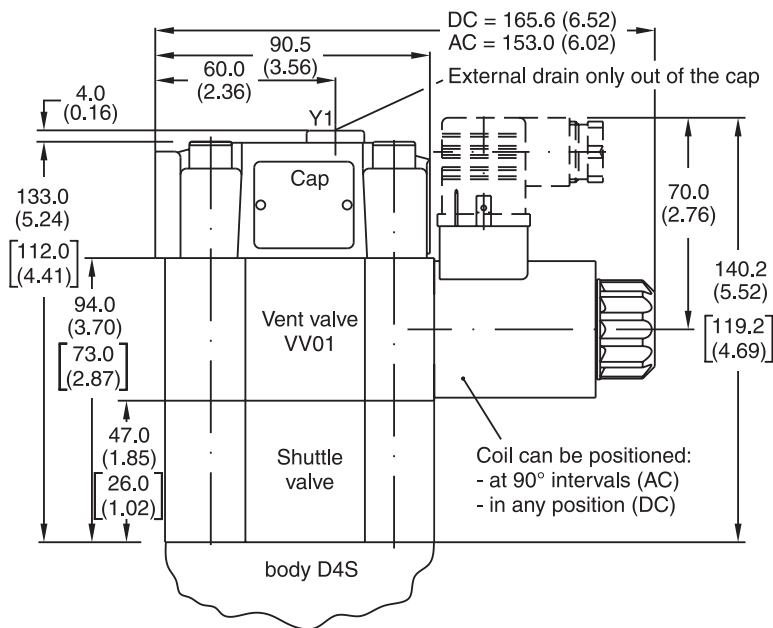

Coil can be positioned:  
- at 90° intervals (AC)  
- in any position (DC)

External drain only out of the cap

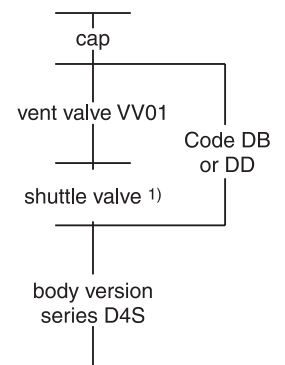
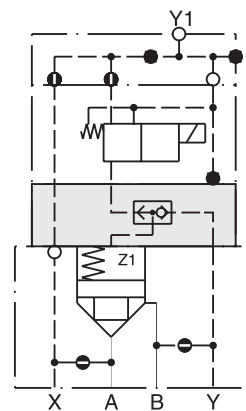
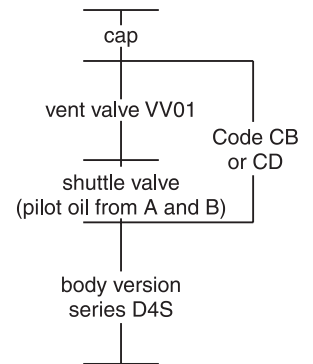
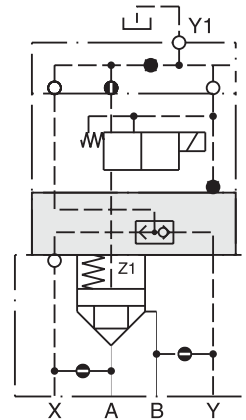

Dimensions in brackets [ ] are for version VV01 with shuttle valve code DB or DD.

**Note:** Shuttle valves only use in connection with vent valve VV01.

1) pilot oil from A and B,  
from B to A check valve function



Inch equivalents for millimeter dimensions are shown in (\*\*)

**A**

**Dimensions D4S Position Control**

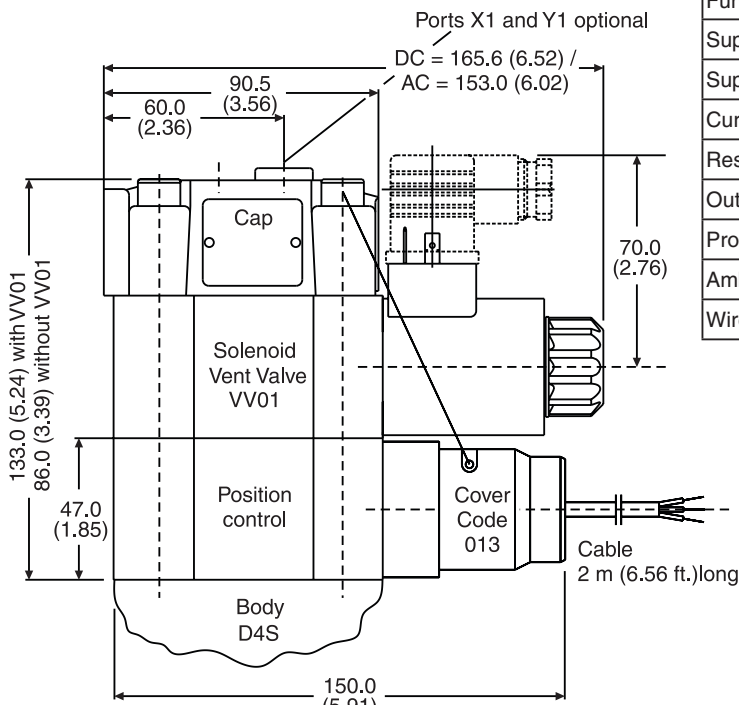

**Technical Information (proximity switch)**

Function		PNP, contact
Supply voltage (Us)	[VDC]	10...30
Supply voltage ripple	[%]	≤ 10
Current consumption	[mA]	max. 8
Residual voltage L-signal	[V]	Us - 2.2 at I <sub>max</sub>
Output current (I)	[mA]	≤ 200
Protection class		IP67
Ambient temperature	[C°]	-25...+70; (-13°F...+158° F)
Wire cross section	[mm <sup>2</sup> ]	3 x 0.5

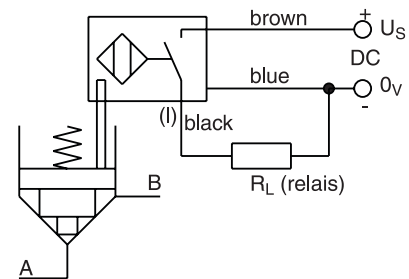
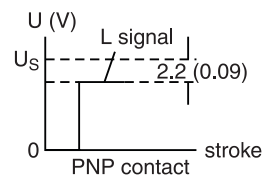

**Position Control by Proximity Switch (incl. Amplifier)**

Valve open: proximity switch activated.  
This proximity switch is pressure proof and has no wearing parts.

Note: Position control for D4S06 and D4S10 only.

**Dimensions D4S Stroke Limiter**

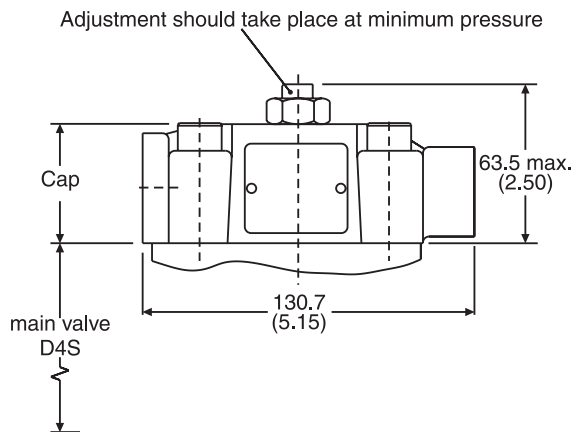

Example: D4S<sup>06</sup><sub>10</sub>-23-3B.

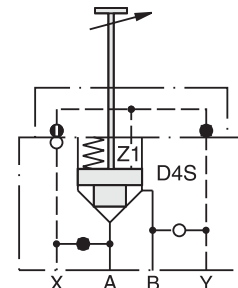

**Note:** Stroke limiter not for use with D4S03, vent valve VV01, shuttle valve and position control.