



Industrial Shock Absorbers

(Linear Decelerators)

Catalog AU08-1022-1/NA
February, 2007



- Compact Designs
- High Effective Weight Capability
- Industry Interchangeable
- Metric and UNF Threads
- Complete Line of Accessories

Parker Actuator has not only established a reputation as the world leader in motion control technology, but in quality as well.

The employees of Parker Hannifin are dedicated to building a quality product, assuring customer satisfaction, and delivering on time.

As a result of this employee focus, Parker Hannifin shock absorbers are built to the **highest standards**. A majority of Parker shock absorber bodies and inner pressure chambers are fully machined from solid alloy steel. A completely closed-end, one-piece pressure chamber is provided without seals or retaining rings.

The advantage of this design is that the Parker shock absorber is able to withstand much higher internal pressures or overload without damage, thereby providing a high operational safety margin.

The features listed on this page are representative of the rugged, dependable components that are built into each Parker shock absorber.

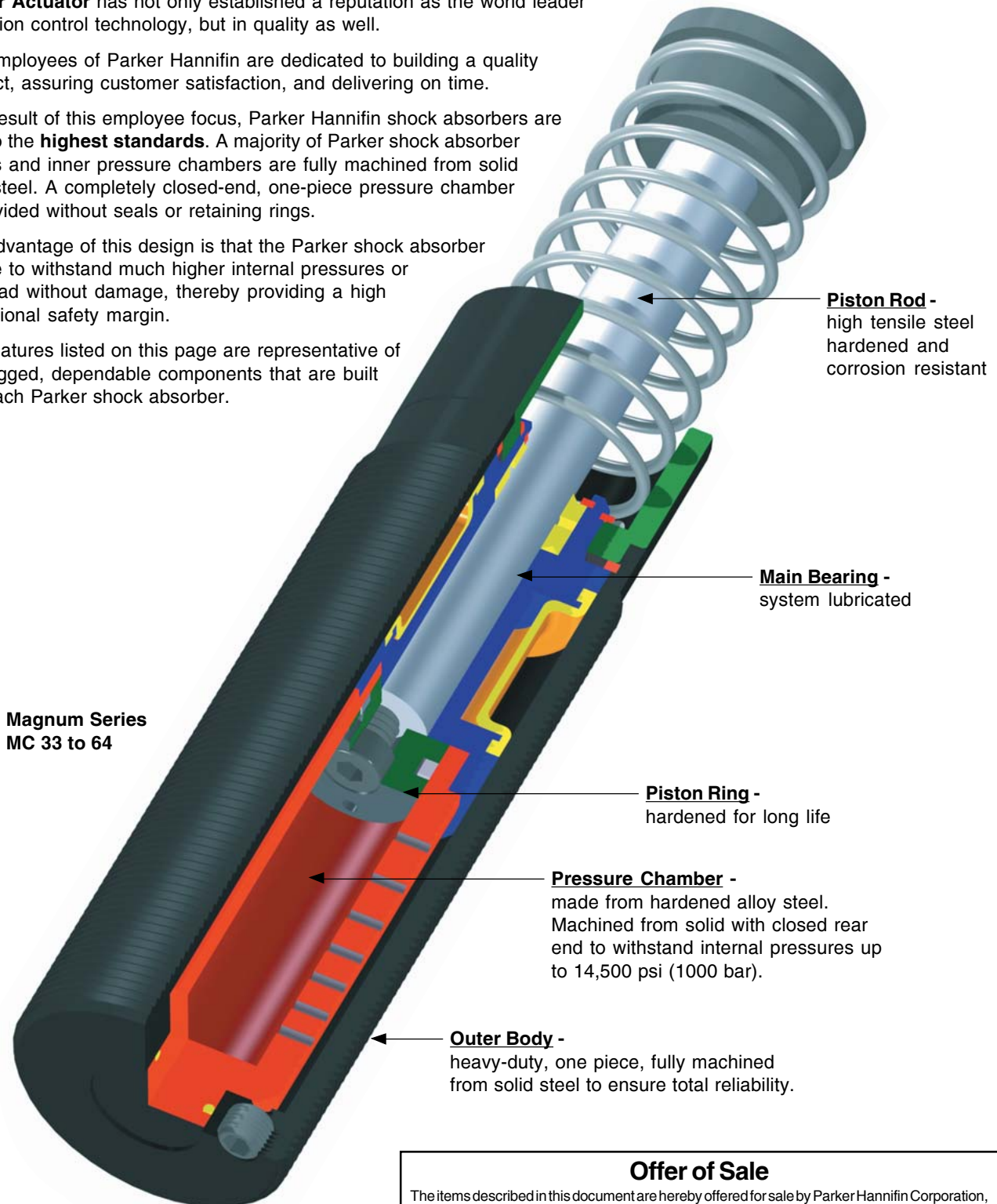

**Magnum Series
MC 33 to 64**

Piston Rod -
high tensile steel
hardened and
corrosion resistant

Main Bearing -
system lubricated

Piston Ring -
hardened for long life

Pressure Chamber -
made from hardened alloy steel.
Machined from solid with closed rear
end to withstand internal pressures up
to 14,500 psi (1000 bar).

Outer Body -
heavy-duty, one piece, fully machined
from solid steel to ensure total reliability.

Offer of Sale

The items described in this document are hereby offered for sale by Parker Hannifin Corporation, its subsidiaries or its authorized distributors. This offer and its acceptance are governed by the provisions stated on the [separate page of this document](#) entitled 'Offer of Sale'.

WARNING

FAILURE OR IMPROPER SELECTION OR IMPROPER USE OF THE PRODUCTS AND/OR SYSTEMS DESCRIBED HEREIN OR RELATED ITEMS CAN CAUSE DEATH, PERSONAL INJURY AND PROPERTY DAMAGE.

This document and other information from Parker Hannifin Corporation, its subsidiaries and authorized distributors provide product and/or system options for further investigation by users having expertise. It is important that you analyze all aspects of your application, including consequences of any failure and review the information concerning the product or system in the current product catalog. Due to the variety of operating conditions and applications for these products or systems, the user, through its own analysis and testing, is solely responsible for making the final selection of the products and systems and assuring that all performance, safety and warning requirements of the application are met.

The products described herein, including without limitation, product features, specifications, designs, availability and pricing, are subject to change by Parker Hannifin Corporation and its related companies at any time without notice.

Table of Contents

	Page No.
Technical Information	
Features and Benefits	2
General Information	4
Deceleration Principles	6
Sizing Examples	8
Installation Examples	12
Model Rating Charts	14
Shock Absorber Selection – Self Compensated, Miniature	
MC9 - MC75	16
MC150 - MC600	18
SC190 - SC925	20
SC300 - SC650, Heavy Weight Shock Absorbers	22
Shock Absorber Selection – Adjustable, Miniature	
MA35 - MA900	24
Magnum Series Shocks	
MC, MA, ML 33 - 64	26
Large Bore Shock Absorbers	
1½" Bore, Adjustable	36
CA Series 2" - 4" Bore, Self Compensated and Adjustable	38
Accessories	
Miniature Shocks	46
Magnum Series Shocks	50
Air Oil Tanks	53
Offer of Sale	54

Miniature Shock Absorbers MC 9 to MC 75

Self-Compensating

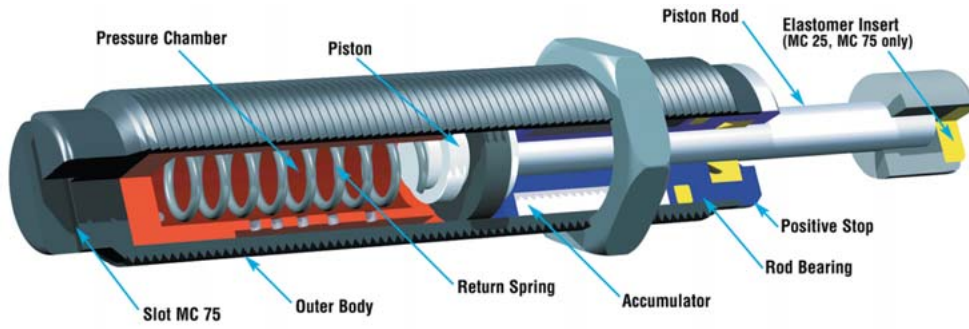

Miniature Shock Absorbers MC 150, MC 225 and MC 600

Self-Compensating

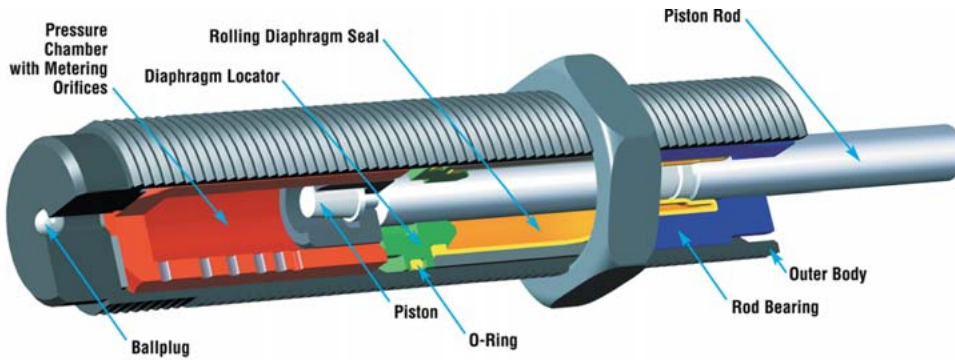

Heavyweight Shock Absorbers SC 300 and SC 650

Soft Contact and Self-Compensating

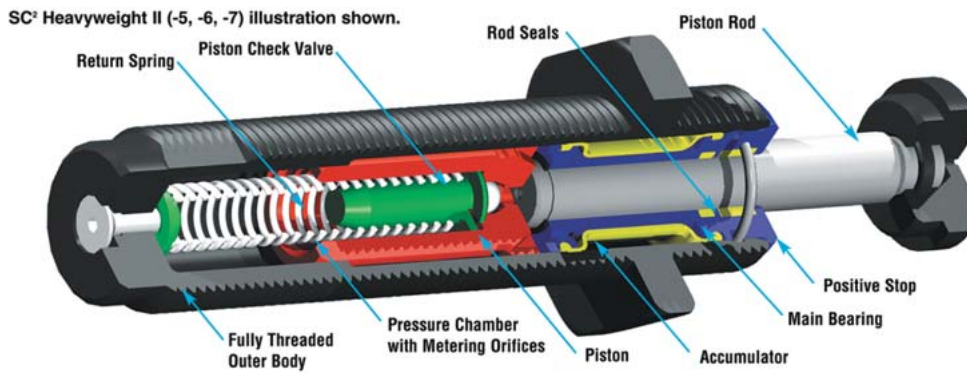

Miniature Shock Absorbers SC 190 to SC 925

Soft Contact and Self-Compensating

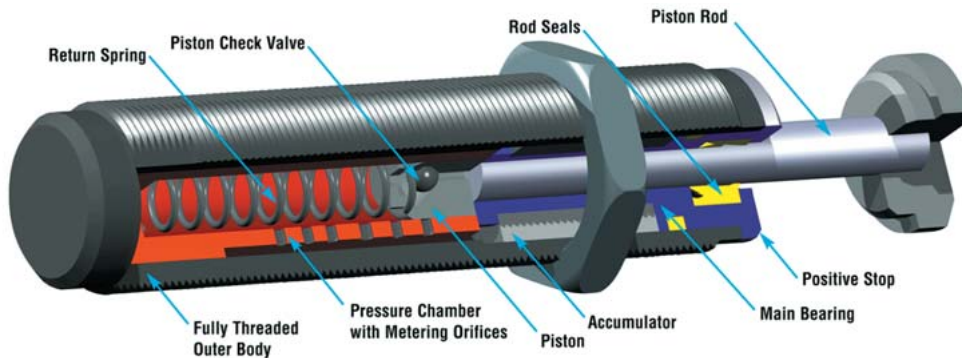

MA Series 225-900 Shock Absorbers (Miniature Adjustable)

Adjustable

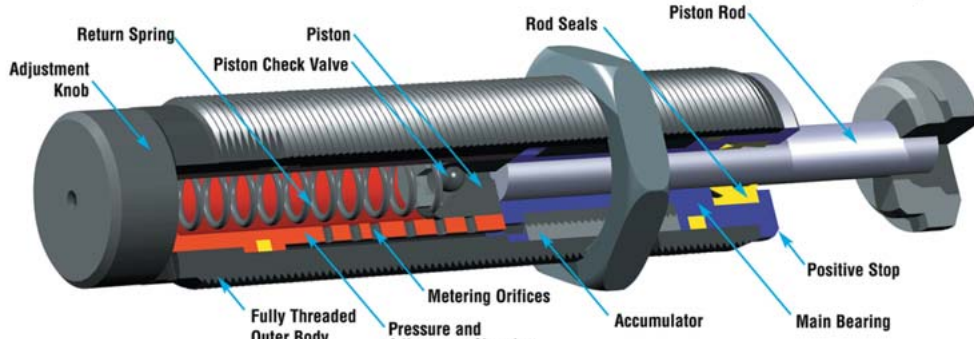

Magnum Series MA and ML 33 to 64

Adjustable

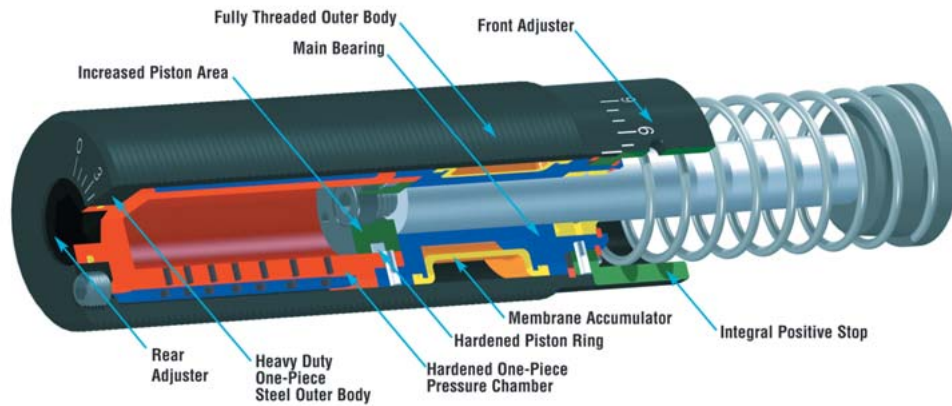

Heavy Industrial Shock Absorbers CA to CA 4

Self-Compensating

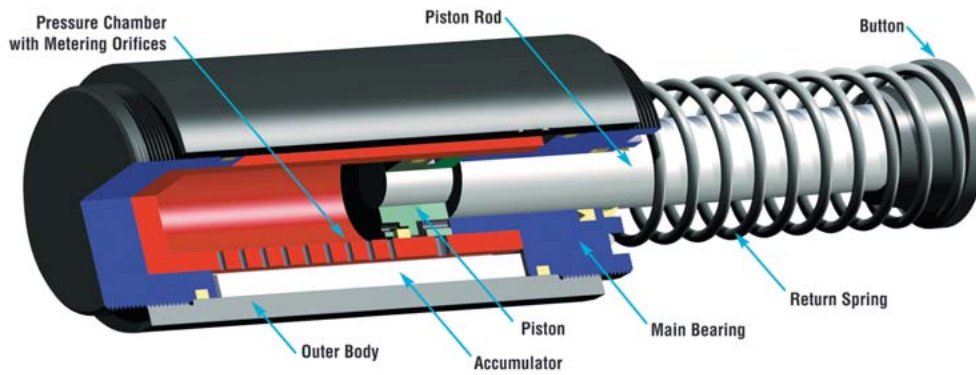

Heavy Industrial Shock Absorbers A2 to A3

Adjustable

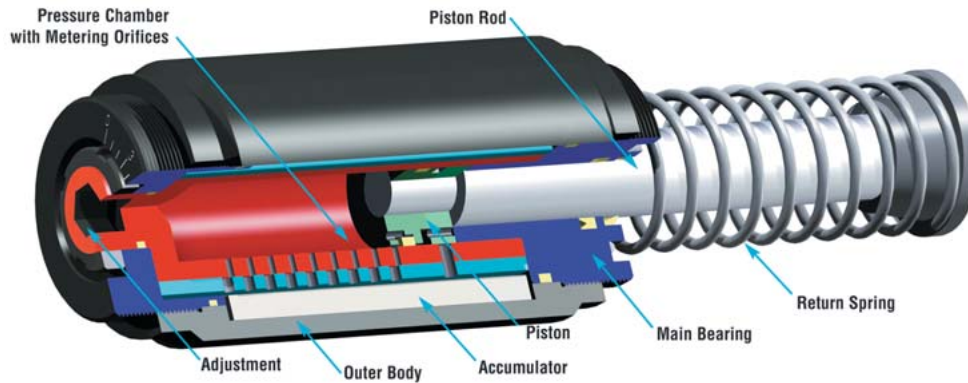

Comparison

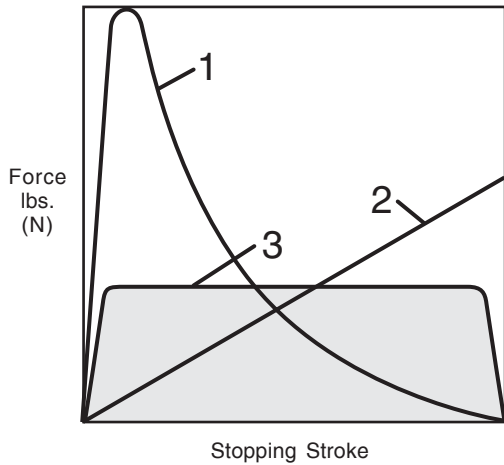

- 1. Cylinder Cushions and Dashpots (High stopping force at start of the stroke).**
 With only one metering orifice, the moving load is abruptly slowed down at the start of the stroke. The braking force rises to a very high peak at the start of the stroke (giving high shock loads) and then falls away rapidly.
- 2. Springs and Rubber Bumpers (High stopping forces at end of stroke).**
 The moving load is slowed down by a constantly rising reaction force up to the point of full compression. These devices store energy rather than dissipate it, which causes the load to bounce back.
- 3. Industrial Shock Absorbers (Uniform stopping force through the entire stroke).** The moving load is smoothly and gently brought to rest by a constant resisting force throughout the entire shock absorber stroke. The load is decelerated with the lowest possible force, in the shortest possible time, eliminating damaging force peaks and shock damage to machines and equipment. This is a linear deceleration force stroke curve and is the curve provided by industrial shock absorbers.

Energy Capacity

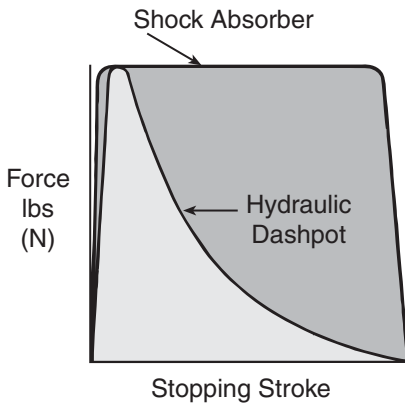

Premise:
 Same maximum reaction force.

Result:
 The shock absorber can absorb considerably more energy (represented by the area under the curve.)

Benefit:
 By installing a shock absorber production rates can be more than doubled without increasing deceleration forces or reaction forces on the machine.

Reaction Force (stopping force)

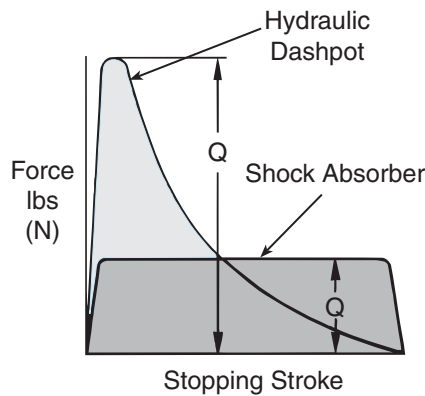

Premise:
 Same energy absorption (area under the curve).

Result:
 The reaction force transmitted by the shock absorber is very much lower.

Benefit:
 By installing the shock absorber the machine wear and maintenance can be drastically reduced.

Stopping Time

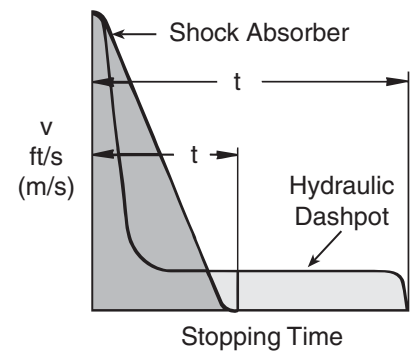

Premise:
 Same energy absorption.

Result:
 The shock absorber stops the moving load in a much shorter time.

Benefit:
 By installing a shock absorber cycle times are reduced giving much higher production rates.

The use of one piece / closed end bodies and inner pressure chambers provides an extremely strong construction, which can withstand much higher internal pressures and overload forces without mechanical damage. Consider what happens if the shock absorber is accidentally overloaded or in the unlikely event of partial oil loss due to excessive seal wear or damage. Compare the internal design used by Parker with that of some of its competitors:

Parker Shock Absorber

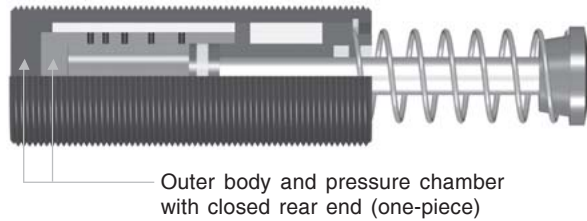

Other Shock Absorber

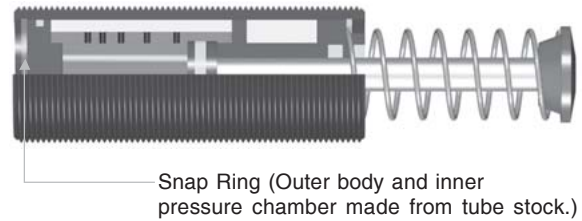

Parker builds its shock absorbers with closed end/one piece bodies and inner pressure chambers, which greatly reduces the chance of sudden failure, or machine damage in the event of an overload.

What happens with an overload or gradual oil loss?
 Harder bottoming out force becomes apparent. The shock absorber continues to work and can be replaced then or at the end of the shift.

Corrective Action:
 Remove and replace the shock absorber. Refill with fresh oil or repair.

Some other manufacturers use bodies and inner pressure chambers made from tube stock. The internal parts are held in by a snap ring etc. which then takes all the load and can fail suddenly and catastrophically.

What happens with an overload or gradual oil loss?
 The snap ring breaks or is extruded due to excessive force. Machine damage!! Equipment Stops!! Production Halted!! Emergency Repair!!

Corrective Action:
 Remove and replace the shock absorber with new one (repair not possible).

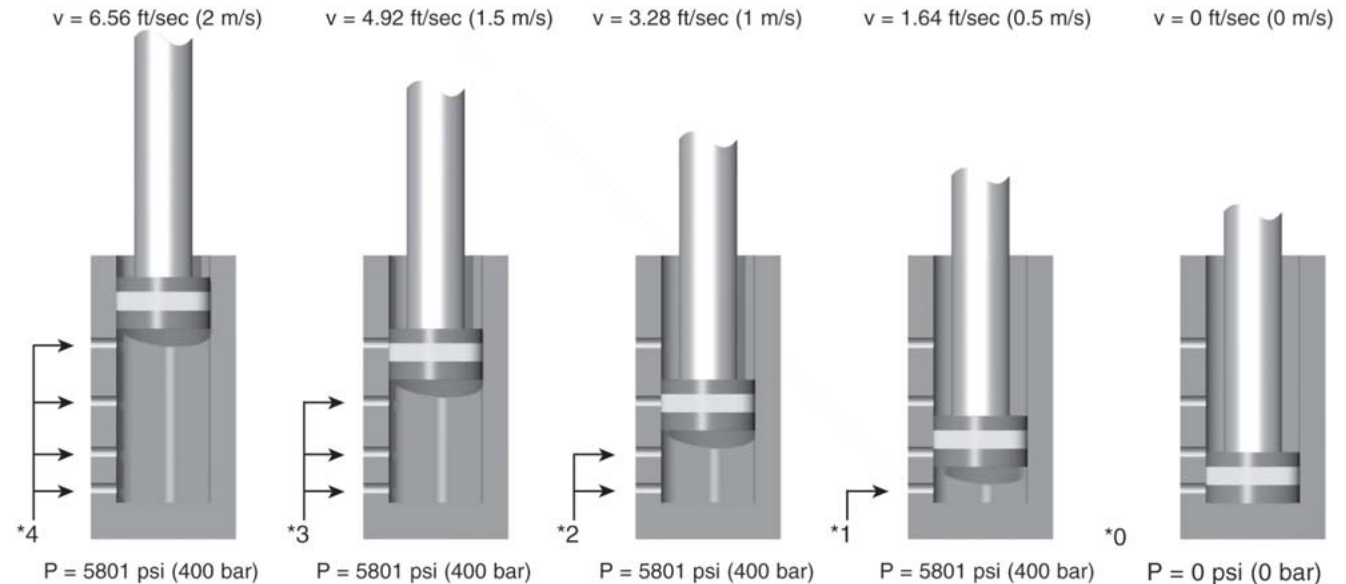

* As a moving load impacts the shock absorber, the piston travels through stroke and forces hydraulic fluid through the multi-orifice inner tube. The total orifice area decreases at a rate consistent with the decay of impact velocity, resulting in true linear deceleration.

- F = Force lbs (N)
- P = Internal pressure psi (bar)
- s = Stroke in (m)
- t = Deceleration time (s)
- v = Velocity ft/s (m/s)

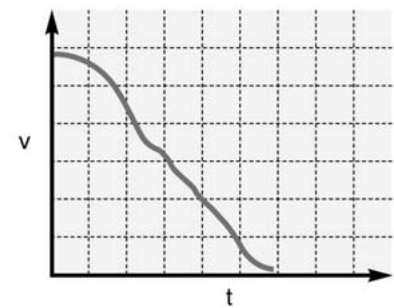
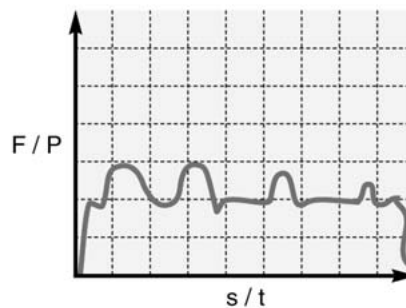

Effective weight is an important factor in selecting shock absorbers. A shock absorber “sees” the impact of an object in terms of weight and velocity only; it does not “see” any propelling force. The effective weight can be thought of as the weight that the shock absorber “sees” on impact. Effective weight includes the effect of the propelling force on the performance of the shock absorber.

Failing to consider the effective weight may result in improper selection and poor performance of the shock absorber. Under extreme conditions, an effective weight that is too low may result in high forces at the start of stroke (high on-set force). However, an effective weight that is too high for the shock absorber may cause high forces at the end of stroke (high set-down force).

Consider the following examples:

- 1.) A 5 lb (2.27 kg) weight travelling at 25 ft/sec (7.62 m/s) has 625 lbs (71 Nm) of kinetic energy (**Figure A**). On this basis alone, an MA 3325 would be selected. However, because there is no propelling force, the calculated effective weight is five pounds – which is below the effective weight range of the standard MA 3325. This is a high on-set force at the start of the stroke (**Figure B**). The solution is to use a specially-orificed shock absorber to handle the load.
- 2.) A weight of 50 lbs (22.68 kg) has an impact velocity of 0.5 ft/sec (0.15 m/s) with a propelling force of 800 lbs (111N) (**Figure C**). The total impact energy is 802.5 inch-pounds. Again, an MA 3325 would be selected based just on the energy. The effective weight is calculated to be 16,050 pounds (7,280 kg). This is well above the range of the standard MA 3325. If this shock absorber is used, high-set-down forces will result (**Figure D**). In this case, the solution is to use a ML 3325, which is designed to work in low-velocity, high-effective weight applications.

Figure A

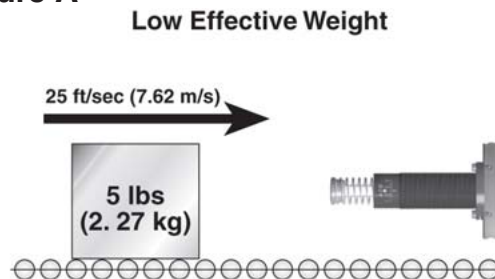

Figure B

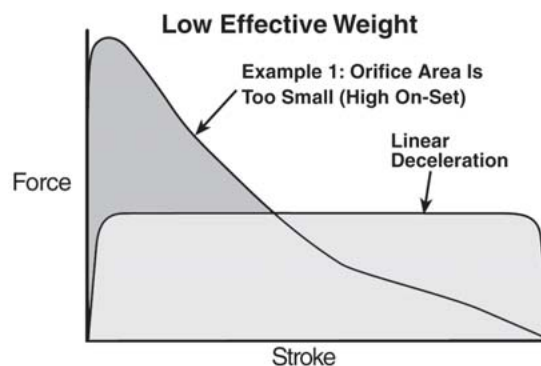

Figure C

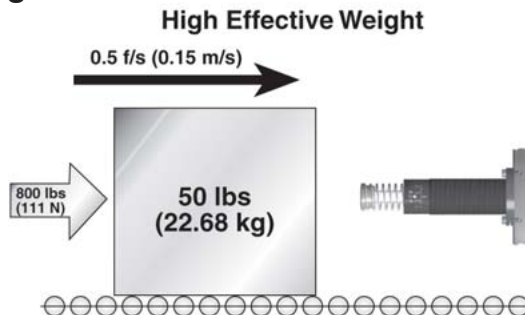
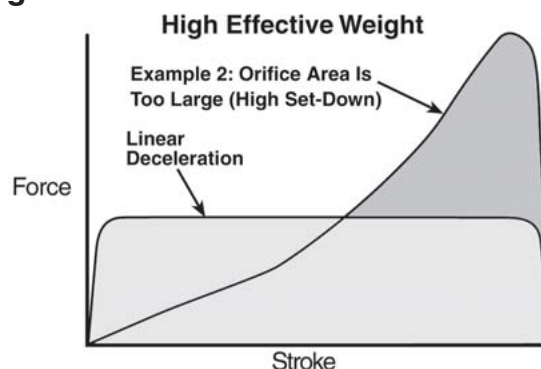

Figure D



Computer-Aided Simulation

By combining application data with a shock absorbers design parameters, Parker engineers can create a picture of how the shock will perform when impacted by the application load. Peak reaction force, peak deceleration (G’s), time through stroke, and velocity decay are identified with extreme accuracy. The user benefits by having the guesswork taken out of sizing decisions and by knowing before installation how his shock problem will be solved.

Self-Compensating Shock Absorbers

In cases where non-adjustability is beneficial but the features of an adjustable shock absorber are required, self-compensating shocks meet both needs. With a range of effective weight, a self-compensating shock absorber will provide acceptable deceleration under changing energy conditions.

The orifice profile, designed by a computer that constantly arranges the size and location of each orifice while inputting changing effective weights, neutralizes the effect of changing fluid coefficients, weight, velocity, temperature and fluid compressibility.

Figure A

A linear decelerator by definition decelerates a moving weight at a linear or constant rate of deceleration. The adjustable shock absorber is able to provide linear deceleration when operated within its energy capacity and effective weight range by dialing in the required orifice area. The resulting force-stroke curve (**Figure A**) shows optimum (lowest) stopping force.

Figure A**Figure B****Figure B**

Figure B shows the force-stroke of a self-compensating shock absorber stopping a weight at the low end of its effective weight range. Note how the reaction forces are no longer constant but are still acceptable. The curve is skewed slightly higher at the beginning of the stroke and dips lower at the end.

Figure C**Figure C**

Figure C is a force-stroke curve of the same self-compensating shock absorber in **Figure B** but at the high end of its effective weight range. The energy curve is now skewed upward at the end of stroke and still yields acceptable deceleration.

Figure D

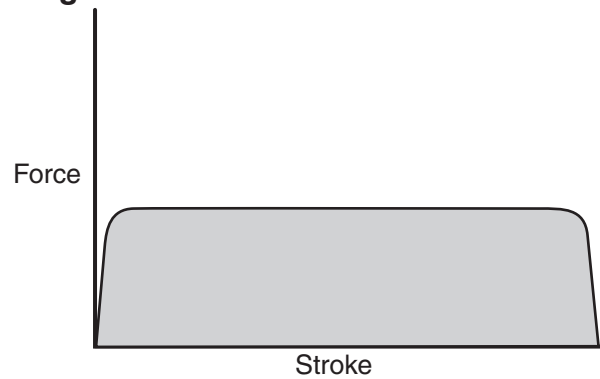
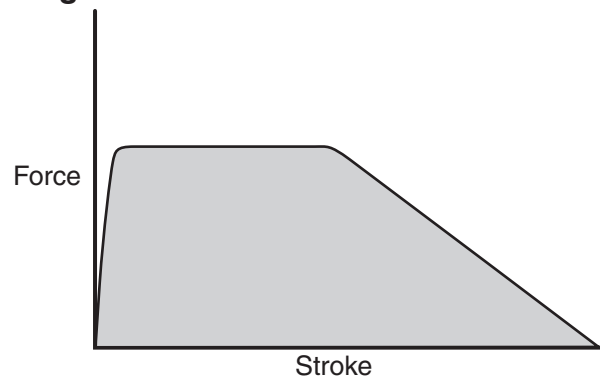
Figure D is a family of force-stroke curves:

- Adjustable shock absorber properly tuned, or hydro shock perfectly matched.
- Self-compensating shock absorber at the low end of its effective weight range.
- Self-compensating shock absorber at the high end of its effective weight range.
- Adjustable closed down, or hydro shock not matched (dashpot effect).

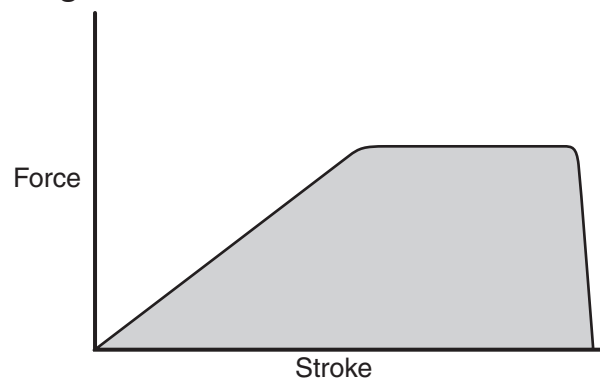
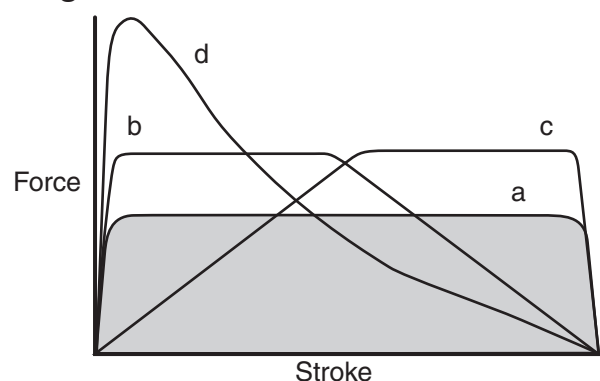
Figure D

W = Moving Weight (lbs)	Hp = Motor Power (horsepower)	E ₁ = Kinetic Energy (in lbs)
V = Impact Velocity (ft/sec)	Mu = Coefficient of Friction	E ₂ = Propelling Force Energy (in lbs)
Fp = Known Propelling Force (lbs)	C = Cycles per Hour (/hour)	E ₃ = Energy per Cycle (in lbs)
B = Propelling Cylinder Bore (inches)	s = Stroke Length of Shock Absorber (inches)	E ₄ = Energy per hour (in lbs/hour)
R = Propelling Cylinder Rod (inches)	F = Propelling Force at Shock Absorber (lbs)	We = Effective Weight (lbs)
P = Air Pressure (psi)		

H1 Weight with No Propelling Force

Examples: Crash Testers, Emergency Stops

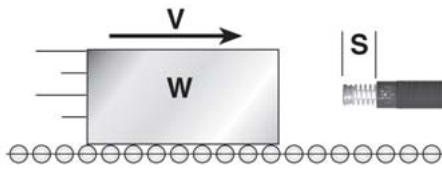

FORMULA

$$E_1 = (0.186) \cdot (W) \cdot (V^2)$$

$$E_2 = (F) \cdot (s)$$

$$E_3 = E_1 + E_2$$

$$E_4 = (E_3) \cdot (C)$$

$$We = E_3 / (0.186) \cdot (V^2)$$

EXAMPLE

W = 500 lbs	E ₁ = (0.186)•(500)•(3 ²) = 837 in lbs
V = 3 ft/sec	E ₂ = (0)•(1) = 0 in lbs
Fp = 0	E ₃ = 900 + 0 = 837 in lbs
C = 500/hour	E ₄ = (837)•(500) = 418,500 in lbs/h
	We = 837 / (0.186)•(3 ²) = 500 lbs

H1 - Select from Model Rating Chart: MC 3325-3 or MA 3325

H2 Weight with Propelling Force

Transfer Devices, Safety Doors, Cutting Shears

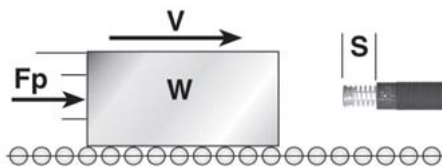

FORMULA

$$F = Fp$$

$$E_1 = (0.186) \cdot (W) \cdot (V^2)$$

$$E_2 = (F) \cdot (s)$$

$$E_3 = E_1 + E_2$$

$$E_4 = (E_3) \cdot (C)$$

$$We = E_3 / (0.186) \cdot (V^2)$$

EXAMPLE

W = 14 lbs	F = 30 = 30 lbs
V = 2.2 ft/sec	E ₁ = (0.186)•(14)•(2.2 ²) = 12.6 in lbs
Fp = 30 lbs	E ₂ = (30)•(0.4) = 12 in lbs
C = 100/hour	E ₃ = 12.6 + 12 = 24.6 in lbs
s = 0.4 inches	E ₄ = (24.6)•(100) = 2,460 in lbs/h
	We = 24.6 / (0.186)•(2.2 ²) = 27.3 lbs

H2 - Select from Model Rating Chart: MC 75-3

H3 Weight with Propelling Cylinder

Pick-and Place Units, Linear Slides, Robotics

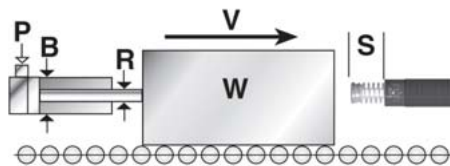

FORMULA

$$F = 0.785 \cdot (B^2 - R^2) \cdot (P)$$

$$E_1 = (0.186) \cdot (W) \cdot (V^2)$$

$$E_2 = (F) \cdot (s)$$

$$E_3 = E_1 + E_2$$

$$E_4 = (E_3) \cdot (C)$$

$$We = E_3 / (0.186) \cdot (V^2)$$

EXAMPLE

W = 120 lbs	F = 0.785•(1.5 ² -0 ²)•60 = 106 lbs
V = 2 ft/sec	E ₁ = (0.186)•(120)•(2 ²) = 89.3 in lbs
B = 1.5 inches	E ₂ = (106)•(0.75) = 79.5 in lbs
R = 0 inches	E ₃ = 89.3 + 79.5 = 168.8 in lbs
P = 60 psi	E ₄ = (168.8)•(60) = 10,128 in lbs/h
C = 60/hour	We = 168.8 / (0.186)•(2 ²) = 226.9 lbs
s = 0.75 inches	

Note: R = 0 when using a rodless cylinder or a cylinder working in extension.

H3 - Select from Model Rating Chart: MA 225 or SC 300-4

H4 Weight with Motor Drive

Lift Trucks, Stacker Units, Overhead Cranes

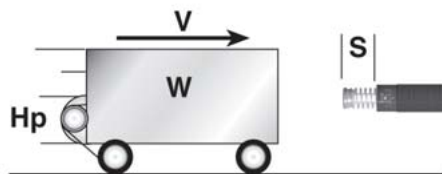

FORMULA

$$F = (550) \cdot (ST) \cdot (Hp) / V$$

$$E_1 = (0.186) \cdot (W) \cdot (V^2)$$

$$E_2 = (F) \cdot (s)$$

$$E_3 = E_1 + E_2$$

$$E_4 = (E_3) \cdot (C)$$

$$We = E_3 / (0.186) \cdot (V^2)$$

EXAMPLE

W = 2,100 lbs	F = (550)•(2.5)•(2) / 1 = 2,750 lbs
V = 1 ft/sec	E ₁ = (0.186)•(2,100)•(1 ²) = 390.6 in lbs
Hp = 2 hp	E ₂ = (2,750)•(2) = 5,500 in lbs
ST = 2.5	E ₃ = 390.6 + 5,500 = 5,890.6 in lbs
C = 20/hour	E ₄ = (5,890.6)•(20) = 117,812 in lbs/h
s = 2 inches	We = 5,890.6 / (0.186)•(1 ²) = 31,670 lbs

H4 - Select from Model Rating Chart: ML 6450 or MC 6450-4

H5 Weight on Power Rollers/Conveyor

Pallet Line, Friction Conveyor Belt, Steel Tube Transfer

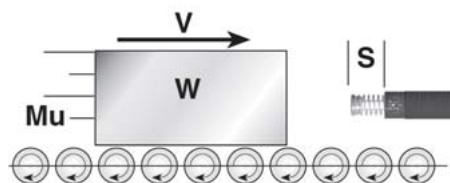

FORMULA

$$F = (W) \cdot (Mu)$$

$$E_1 = (0.186) \cdot (W) \cdot (V^2)$$

$$E_2 = (F) \cdot (s)$$

$$E_3 = E_1 + E_2$$

$$E_4 = (E_3) \cdot (C)$$

$$We = E_3 / (0.186) \cdot (V^2)$$

EXAMPLE

W = 250 lbs	F = (250)•(0.2) = 50 lbs
V = 2.5 ft/sec	E ₁ = (0.186)•(250)•(2.5 ²) = 290.6 in lbs
Mu = 0.2	E ₂ = (50)•(1) = 50 in lbs
C = 180/hour	E ₃ = 290.6 + 50 = 340.6 in lbs
s = 1 inch	E ₄ = (340.6)•(180) = 61,308 in lbs/h
	We = 340.6 / (0.186)•(2.5 ²) = 293 lbs

H5 - Select from Model Rating Chart: MA 600 or SC 650-3

W = Moving Weight (lbs)	A = Angle of Inclined Plane (°)	E ₁ = Kinetic Energy (in lbs)
V = Impact Velocity (ft/sec)	W _{cw} = Counter Weight (lbs)	E ₂ = Propelling Force Energy (in lbs)
F _p = Known Propelling Force (lbs)	C = Cycles per Hour (/hour)	E ₃ = Energy per Cycle (in lbs)
M = Total Distance Moved by Weight (inches)	s = Stroke Length of Shock Absorber (inches)	E ₄ = Energy per hour (in lbs/hour)
D = Distance Moved by Weight to Shock (inches)	F = Propelling Force at Shock Absorber (lbs)	We = Effective Weight (lbs)

V1 Weight, Vertical Free Fall

Examples: Elevator Emergency Stops, Flying Shears, Test Equipment

FORMULA

$$D = (M) - (s)$$

$$V = \sqrt{(5.4) \cdot (D) \cdot \sin(A)}$$

$$F = (W) \cdot \sin(A)$$

$$E_1 = (0.186) \cdot (W) \cdot (V^2)$$

$$E_2 = (F) \cdot (s)$$

$$E_3 = E_1 + E_2$$

$$E_4 = (E_3) \cdot (C)$$

$$We = E_3 / (0.186) \cdot (V^2)$$

EXAMPLE

W = 200 lbs
M = 18 inches
C = 60/hour
s = 3 inches

$$D = (18) - (3) = 15 \text{ inches}$$

$$V = \sqrt{(5.4) \cdot (15)} = 9 \text{ ft/sec}$$

$$F = 200 = 200 \text{ lbs}$$

$$E_1 = (0.186) \cdot (200) \cdot (9^2) = 3,013.2 \text{ in lbs}$$

$$E_2 = (200) \cdot (3) = 600 \text{ in lbs}$$

$$E_3 = 3,013.2 + 600 = 3,613.2 \text{ in lbs}$$

$$E_4 = (3,013.2) \cdot (60) = 216,792 \text{ in lbs/h}$$

$$We = 3,013.2 / (0.186) \cdot (9^2) = 239.8 \text{ lbs}$$

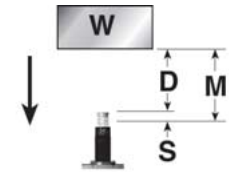

V1 - Select from Model Rating Chart: MA 4575

V2 Weight Sliding Down Incline

Inclined Non-Powered Conveyor, Package Chute, Parts Transfer Ramp

$$D = (M) - (s)$$

$$V = \sqrt{(5.4) \cdot (D) \cdot \sin(A)}$$

$$F = (W) \cdot \sin(A)$$

$$E_1 = (0.186) \cdot (W) \cdot (V^2)$$

$$E_2 = (F) \cdot (s)$$

$$E_3 = E_1 + E_2$$

$$E_4 = (E_3) \cdot (C)$$

$$We = E_3 / (0.186) \cdot (V^2)$$

W = 1,000 lbs
M = 15 inches
A = 30°
C = 190/hour
s = 2 inches

$$D = (15) - (2) = 13 \text{ inches}$$

$$V = \sqrt{(5.4) \cdot (13) \cdot \sin(30)} = 5.9 \text{ ft/sec}$$

$$F = 500 = 500 \text{ lbs}$$

$$E_1 = (0.186) \cdot (1,000) \cdot (5.9^2) = 6,474.7 \text{ in lbs}$$

$$E_2 = (500) \cdot (2) = 1,000 \text{ in lbs}$$

$$E_3 = 6,474.7 + 1,000 = 7,474.7 \text{ in lbs}$$

$$E_4 = (7,474.7) \cdot (190) = 1,420,193 \text{ in lbs/h}$$

$$We = 7,474.7 / (0.186) \cdot (5.9^2) = 1,154.5 \text{ lbs}$$

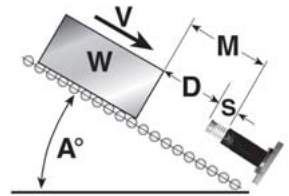

V2 - Select from Model Rating Chart: MCA 6450-1 or -2

V3 Down Incline with Propelling Force

Inclined Conveyor Belt, High Speed Safety Doors

$$F = (W) \cdot \sin(A) + (F_p)$$

$$E_1 = (0.186) \cdot (W) \cdot (V^2)$$

$$E_2 = (F) \cdot (s)$$

$$E_3 = E_1 + E_2$$

$$E_4 = (E_3) \cdot (C)$$

$$We = E_3 / (0.186) \cdot (V^2)$$

W = 100 lbs
V = 2 ft/sec
F_p = 50 lbs
A = 15°
C = 30/hour
s = 0.5 inches

$$F = (100) \cdot \sin(15) + (50) = 75.9$$

$$E_1 = (0.186) \cdot (100) \cdot (2^2) = 74.4 \text{ in lbs}$$

$$E_2 = (75.9) \cdot (0.5) = 38 \text{ in lbs}$$

$$E_3 = 74.4 + 38 = 112.4 \text{ in lbs}$$

$$E_4 = (112.4) \cdot (30) = 3,370.5 \text{ in lbs}$$

$$We = 112.4 / (0.186) \cdot (2^2) = 151.1 \text{ lbs}$$

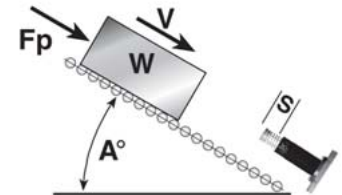

V3 - Select from Model Rating Chart: MC 150H

V4 Up Incline with Propelling Force

Elevator, Inclined Power Conveyor

$$F = (F_p) - (W) \cdot \sin(A)$$

$$E_1 = (0.186) \cdot (W) \cdot (V^2)$$

$$E_2 = (F) \cdot (s)$$

$$E_3 = E_1 + E_2$$

$$E_4 = (E_3) \cdot (C)$$

$$We = E_3 / (0.186) \cdot (V^2)$$

W = 450 lbs
V = 1 ft/sec
F_p = 600 lbs
A = 90°
C = 60/hour
s = 1 inch

$$F = (600) - (450) \cdot \sin(90) = 150 \text{ lbs}$$

$$E_1 = (0.186) \cdot (450) \cdot (1^2) = 83.7 \text{ in lbs}$$

$$E_2 = (150) \cdot (1) = 150 \text{ in lbs}$$

$$E_3 = 83.7 + 150 = 234 \text{ in lbs}$$

$$E_4 = (234) \cdot (60) = 14,022 \text{ in lbs/h}$$

$$We = 234 / (0.2) \cdot (1^2) = 1,258.1 \text{ lbs}$$

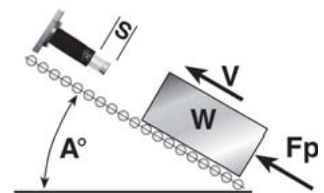

V4 - Select from Model Rating Chart: MA 600 or SC 650-4

V5 Down Incline with Counter Weight

Lifting Door with Counter Balance

$$F = (W) \cdot \sin(A) - W_{cw}$$

$$E_1 = (0.186) \cdot (W) \cdot (V^2)$$

$$E_2 = (F) \cdot (s)$$

$$E_3 = E_1 + E_2$$

$$E_4 = (E_3) \cdot (C)$$

$$We = E_3 / (0.186) \cdot (V^2)$$

W = 1,500 lbs
V = 0.5 ft/sec
A = 45°
W_{cw} = 500 lbs
C = 1/hour
s = 1 inch

$$F = (1,500) \cdot \sin(45) - 500 = 560.7 \text{ lbs}$$

$$E_1 = (0.186) \cdot (1,500) \cdot (0.5^2) = 69.8 \text{ in lbs}$$

$$E_2 = (560.7) \cdot (1) = 560.7 \text{ in lbs}$$

$$E_3 = 69.8 + 560.7 = 630.5 \text{ in lbs}$$

$$E_4 = (630.5) \cdot (1) = 630.5 \text{ in lbs/h}$$

$$We = 630.5 / (0.186) \cdot (0.5^2) = 13,559.1 \text{ lbs}$$

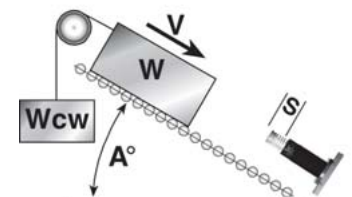

V5 - Select from Model Rating Chart: ML 3325

W = Moving Weight (lbs)	T = Propelling Torque (lbs-in)	C = Cycles per Hour (/hour)
V = Impact Velocity (ft/sec)	Rs = Mounting Radius of the Shock (inches)	E ₁ = Kinetic Energy (in lbs)
Wa = Apparent Weight at Shock Absorber (lbs)	Rt = Radius to Edge of Turntable (inches)	E ₂ = Propelling Force Energy (in lbs)
ω = Angular Velocity (°/sec)	s = Stroke Length of Shock Absorber (inches)	E ₃ = Energy per Cycle (in lbs)
I = Moment of Inertia (lb-ft-sec ²)	H = Thickness of Object (inches)	E ₄ = Energy per hour (in lbs/hour)
k = Radius of Gyration (inches)	L = Length of Object (inches)	We = Effective Weight (lbs)

R1 Moment of Inertia, Horizontal Plane

Examples: Swing Bridges, Radar Antenna

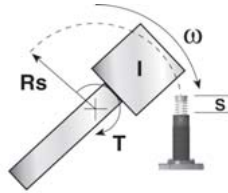

FORMULA

$$Wa = (4637 \cdot I) / (Rs^2)$$

$$V = (Rs) \cdot (\omega) / 688$$

$$F = T / Rs$$

$$E_1 = (0.186) \cdot (Wa) \cdot (V^2)$$

$$E_2 = (F) \cdot (s)$$

$$E_3 = E_1 + E_2$$

$$E_4 = (E_3) \cdot (C)$$

$$We = E_3 / (0.186) \cdot (V^2)$$

EXAMPLE

$$I = 3,930 \text{ lb-ft-sec}^2$$

$$\omega = 172^\circ/\text{sec}$$

$$T = 480,000 \text{ lbs-in}$$

$$Rs = 40 \text{ inches}$$

$$C = 30/\text{hour}$$

$$s = 6 \text{ inches}$$

$$Wa = (4,637 \cdot 3,930) / (40^2) = 11,390 \text{ lbs}$$

$$V = (40) \cdot (172) / 688 = 10 \text{ ft/sec}$$

$$F = 480,000 / 40 = 12,000 \text{ lbs}$$

$$E_1 = (0.186) \cdot (11,390) \cdot (10^2) = 211,854 \text{ in lbs}$$

$$E_2 = (12,000) \cdot (6) = 72,000 \text{ in lbs}$$

$$E_3 = 211,854 + 72,000 = 283,854 \text{ in lbs}$$

$$E_4 = (283,854) \cdot (30) = 8,515,620 \text{ in lbs/hour}$$

$$We = 283,854 / (0.186) \cdot (10^2) = 15,260.9 \text{ lbs}$$

R1 - Select from Model Rating Chart: CA 4 x 6-3

R2 Radius of Gyration, Horizontal Plane

Examples: Packaging Equipment, Pick-and-Place Robots

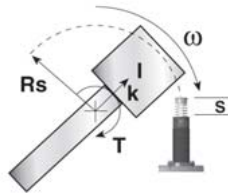

FORMULA

$$Wa = (W) \cdot (k^2) / (Rs^2)$$

$$V = (Rs) \cdot (\omega) / 688$$

$$F = T / Rs$$

$$E_1 = (0.186) \cdot (Wa) \cdot (V^2)$$

$$E_2 = (F) \cdot (s)$$

$$E_3 = E_1 + E_2$$

$$E_4 = (E_3) \cdot (C)$$

$$We = E_3 / (0.186) \cdot (V^2)$$

EXAMPLE

$$W = 300 \text{ lbs}$$

$$k = 2.5 \text{ inches}$$

$$\omega = 180^\circ/\text{sec}$$

$$T = 9,000 \text{ lbs-in}$$

$$Rs = 25 \text{ inches}$$

$$C = 1,200/\text{hour}$$

$$s = 1 \text{ inch}$$

$$Wa = (300) \cdot (2.5^2) / (25^2) = 3 \text{ lbs}$$

$$V = (25) \cdot (180) / 688 = 6.54 \text{ ft/sec}$$

$$F = 9,000 / 25 = 360 \text{ lbs}$$

$$E_1 = (0.186) \cdot (3) \cdot (6.54^2) = 23.87 \text{ in lbs}$$

$$E_2 = (360) \cdot (1) = 360 \text{ in lbs}$$

$$E_3 = 23.87 + 360 = 383.87 \text{ in lbs}$$

$$E_4 = (383.87) \cdot (1,200) = 460,644 \text{ in lbs/h}$$

$$We = 383.87 / (0.186) \cdot (6.54^2) = 48.20 \text{ lbs}$$

R2 - Select from Model Rating Chart: MC 3325-1 or MA 3325

R3 Index Table

Examples: Index Table, Rotating Work Station

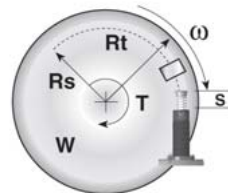

FORMULA

$$Wa = (W \cdot Rt^2) / (2 \cdot Rs^2)$$

$$V = (Rs) \cdot (\omega) / 688$$

$$F = T / Rs$$

$$E_1 = (0.186) \cdot (Wa) \cdot (V^2)$$

$$E_2 = (F) \cdot (s)$$

$$E_3 = E_1 + E_2$$

$$E_4 = (E_3) \cdot (C)$$

$$We = E_3 / (0.186) \cdot (V^2)$$

EXAMPLE

$$W = 195 \text{ lbs}$$

$$Rt = 20 \text{ inches}$$

$$\omega = 85^\circ/\text{sec}$$

$$T = 1,700 \text{ lbs-in}$$

$$Rs = 15 \text{ inches}$$

$$C = 60/\text{hour}$$

$$s = .75 \text{ inches}$$

$$Wa = (195 \cdot 20^2) / (2 \cdot 15^2) = 173.3 \text{ lbs}$$

$$V = (15) \cdot (85) / 688 = 1.85 \text{ ft/sec}$$

$$F = 1,700 / 15 = 113.3 \text{ lbs}$$

$$E_1 = (0.186) \cdot (173.3) \cdot (1.85^2) = 110.3 \text{ in lbs}$$

$$E_2 = (113.3) \cdot (0.75) = 85 \text{ in lbs}$$

$$E_3 = 110.3 + 85 = 195.3 \text{ in lbs}$$

$$E_4 = (195.3) \cdot (60) = 11,718 \text{ in lbs/h}$$

$$We = 195.3 / (0.186) \cdot (1.85^2) = 306.8 \text{ lbs}$$

R3 - Select from Model Rating Chart: SC 300-4 or MC 225H

R4 Turnover

Examples: Roll-Over Device, Paint Booths, Crate Handling

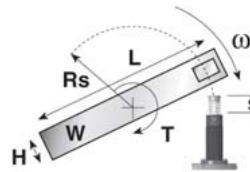

FORMULA

$$Wa = (W) \cdot (H^2 + L^2) / (12 \cdot (Rs^2))$$

$$V = (Rs) \cdot (\omega) / 688$$

$$F = T / Rs$$

$$E_1 = (0.186) \cdot (Wa) \cdot (V^2)$$

$$E_2 = (F) \cdot (s)$$

$$E_3 = E_1 + E_2$$

$$E_4 = (E_3) \cdot (C)$$

$$We = E_3 / (0.186) \cdot (V^2)$$

EXAMPLE

$$W = 150 \text{ lbs}$$

$$L = 38 \text{ inches}$$

$$H = 1 \text{ inch}$$

$$\omega = 70^\circ/\text{sec}$$

$$T = 15,000 \text{ lbs-in}$$

$$Rs = 12 \text{ inches}$$

$$C = 500/\text{hour}$$

$$s = 1 \text{ inch}$$

$$Wa = (150) \cdot (1^2 + 38^2) / (12 \cdot (12^2)) = 125.43 \text{ lbs}$$

$$V = (12) \cdot (70) / 688 = 1.22 \text{ ft/sec}$$

$$F = 15,000 / 12 = 1,250 \text{ lbs}$$

$$E_1 = (0.186) \cdot (125.43) \cdot (1.22^2) = 34.72 \text{ in lbs}$$

$$E_2 = (1,250) \cdot (1) = 1,250 \text{ in lbs}$$

$$E_3 = 34.72 + 1,250 = 1,284.72 \text{ in lbs}$$

$$E_4 = (1,284.72) \cdot (500) = 642,360 \text{ in lbs/h}$$

$$We = 1,284.72 / (0.186) \cdot (1.22^2) = 4,640.6 \text{ lbs}$$

R4 - Select from Model Rating Chart: MC 4525-4 or MA 4525

R5 Uniform Bar, Horizontal Plane

Examples: Swinging Beam, Robotic Arm

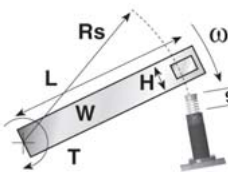

FORMULA

$$Wa = (W) \cdot (H^2 + 4 \cdot L^2) / (12 \cdot (Rs^2))$$

$$V = (Rs) \cdot (\omega) / 688$$

$$F = T / Rs$$

$$E_1 = (0.186) \cdot (Wa) \cdot (V^2)$$

$$E_2 = (F) \cdot (s)$$

$$E_3 = E_1 + E_2$$

$$E_4 = (E_3) \cdot (C)$$

$$We = E_3 / (0.186) \cdot (V^2)$$

EXAMPLE

$$W = 75 \text{ lbs}$$

$$L = 30 \text{ inches}$$

$$H = 2 \text{ inches}$$

$$\omega = 180^\circ/\text{sec}$$

$$T = 9,000 \text{ lbs-in}$$

$$Rs = 15 \text{ inches}$$

$$C = 100/\text{hour}$$

$$s = 1 \text{ inch}$$

$$Wa = (75) \cdot (2^2 + 4 \cdot 30^2) / (12 \cdot (15^2)) = 100.1 \text{ lbs}$$

$$V = (15) \cdot (180) / 688 = 3.92 \text{ ft/sec}$$

$$F = 9,000 / 15 = 600 \text{ lbs}$$

$$E_1 = (0.186) \cdot (100.1) \cdot (3.92^2) = 286.1 \text{ in lbs}$$

$$E_2 = (600) \cdot (1) = 600 \text{ in lbs}$$

$$E_3 = 286.1 + 600 = 886.1 \text{ in lbs}$$

$$E_4 = (886.1) \cdot (100) = 88,610 \text{ in lbs/h}$$

$$We = 886.1 / (0.186) \cdot (3.92^2) = 310 \text{ lbs}$$

R5 - Select from Model Rating Chart: MC 4525-2 or MA 4525

W = Moving Weight (lbs)	T = Propelling Torque (lbs in)	E ₁ = Kinetic Energy (in lbs)
H = Thickness of Door or Arm (inches)	θ = Angle from the Vertical (°)	E ₂ = Propelling Force Energy (in lbs)
L = Length of Door or Arm (inches)	C = Cycles per Hour (/hour)	E ₃ = Energy per Cycle (in lbs)
d = Distance from Pivot to c of g (inches)	s = Stroke Length of Shock Absorber (inches)	E ₄ = Energy per hour (in lbs/hour)
Rs = Mounting Radius of Shock Absorbers (inches)	F = Propelling Force at Shock Absorber (lbs)	We = Effective Weight (lbs)
ω = Rotational Speed of Weight (°/sec)		

R6 Uniform Bar, Vertical Plane

Examples: Cross-Conveyor Transfer, Gantry Walkway

FORMULA	EXAMPLE	
W _a = (W)•(H ² +4•L ²)/12•(Rs ²)	W = 5 lbs	W _a = (5)•(.25 ² +4•6 ²)/12•(6 ²) = 1.7 lbs
V = (Rs)•(ω)/688	H = .25 inches	V = (6)•(360)/688 = 3.1 ft/sec
F = [T+.5•L•W•SIN(θ)]/Rs	L = 6 inches	F = [20+.5•6•5•SIN(87.6)]/6 = 5.8 lbs
E ₁ = (0.186)•(W _a)•(V ²)	θ = 87.6°	E ₁ = (0.186)•(1.7)•(3.1 ²) = 3.0 in lbs
E ₂ = (F)•(s)	ω = 360°/sec	E ₂ = (5.8)•(.25) = 1.5 in lbs
E ₃ = E ₁ + E ₂	T = 20 lbs-in	E ₃ = 3.3 + 1.5 = 4.8 in lbs
E ₄ = (E ₃)•(C)	Rs = 6 inches	E ₄ = (4.5)•(1,800) = 8,100 in lbs/h
We = E ₃ / (0.186)•(V ²)	C = 1,800/hour	We = 4.5 / (0.186)•(3.1 ²) = 2.5 lbs
	s = .25 inches	

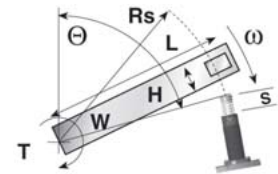

R6 - Select from Model Rating Chart: MC 25L

R7 Door, Horizontal Plane

Examples: Cabinet Doors, Machine Enclosures

W _a = (W)•(H ² +L ²)/(3•Rs ²)	W = 120 lbs	W _a = (120)•(1 ² +42 ²)/(3•10 ²) = 706 lbs
V = (Rs)•(ω)/688	H = 1 inch	V = (10)•(60)/688 = .9 ft/sec
F = t/Rs	L = 42 inches	F = 1,800/10 = 180 lbs
E ₁ = (0.186)•(W _a)•(V ²)	ω = 60°/sec	E ₁ = (0.186)•(706)•(.9 ²) = 106.4 in lbs
E ₂ = (F)•(s)	T = 1,800 lbs-in	E ₂ = (180)•(.5) = 90 in lbs
E ₃ = E ₁ + E ₂	Rs = 10 inches	E ₃ = 106.4 + 90 = 196.4 in lbs
E ₄ = (E ₃)•(C)	C = 4/hour	E ₄ = (196.4)•(4) = 785 in lbs/h
We = E ₃ / (0.186)•(V ²)	s = .5 inches	We = 196.4 / (0.186)•(.9 ²) = 1,303.6 lbs

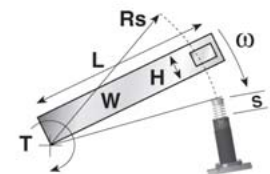

R7 - Select from Model Rating Chart: MC 225H2

R8 Door, Vertical Plane

Examples: Hatches, Lids, Hoods

W _a = (W)•(H ² +L ²)/(3•Rs ²)	W = 60 lbs	W _a = (60)•(1 ² +10 ²)/(3•10 ²) = 20.2 lbs
V = (Rs)•(ω)/688	H = 1 inch	V = (10)•(200)/688 = 2.9 ft/sec
F* = [T+.5•L•W•SIN(θ)]/Rs	L = 10 inches	F = [45+.5•10•60•SIN(150)]/10 = 19.5 lbs
E ₁ = (0.186)•(W _a)•(V ²)	θ = 150°	E ₁ = (0.186)•(20.2)•(2.9 ²) = 31.6 in lbs
E ₂ = (F)•(s)	ω = 200°/sec	E ₂ = (19.5)•(0.63) = 12.3 in lbs
E ₃ = E ₁ + E ₂	T = 45 lbs-in	E ₃ = 34 + 12.3 = 43.9 in lbs
E ₄ = (E ₃)•(C)	Rs = 10 inches	E ₄ = (43.9)•(1,900) = 83,382 in lbs/h
We = E ₃ / (0.186)•(V ²)	C = 1,900/hour	We = 43.9 / (0.186)•(2.9 ²) = 28.1 lbs

*Force is approximate

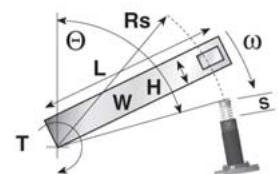

R8 - Select from Model Rating Chart: SC 190-2

R9 Weight at Radius, Horizontal Plane

Examples: Circuit Breakers, Swinging Gates

W _a = (W)•(d ²)/(Rs ²)	W = 40 lbs	W _a = (40)•(8 ²)/(7 ²) = 52 lbs
V = (Rs)•(ω)/688	d = 8 inches	V = (7)•(110)/688 = 1.1 ft/sec
F = T/Rs	ω = 110°/sec	F = 150/7 = 21 lbs
E ₁ = (0.186)•(W _a)•(V ²)	T = 150 lbs-in	E ₁ = (0.186)•(52)•(1.1 ²) = 11.7 in lbs
E ₂ = (F)•(s)	Rs = 7 inches	E ₂ = (21)•(.5) = 10.5 in lbs
E ₃ = E ₁ + E ₂	C = 1,500/hour	E ₃ = 11.7 + 10.5 = 22.2 in lbs
E ₄ = (E ₃)•(C)	s = .5 inches	E ₄ = (22.2)•(1,500) = 33,300 in lbs/h
We = E ₃ / (0.186)•(V ²)		We = 22.2 / (0.186)•(1.1 ²) = 98.6 lbs

R9 - Select from Model Rating Chart: MC 150H

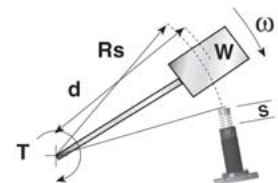

R10 Weight at Radius, Vertical Plane

Examples, Impact Testers, Pendulums

W _a = (W)•(d ²)/(Rs ²)	W = 40 lbs	W _a = (40)•(8 ²)/(7 ²) = 52 lbs
V = (Rs)•(ω)/688	d = 8 inches	V = (7)•(110)/688 = 1.1 ft/sec
F* = [T+W•d•SIN(θ)]/Rs	θ = 90°	F = [150+40•8•SIN(90)]/7 = 67 lbs
E ₁ = (0.186)•(W _a)•(V ²)	ω = 110°/sec	E ₁ = (0.186)•(52)•(1.1 ²) = 11.7 in lbs
E ₂ = (F)•(s)	T = 150 lbs-in	E ₂ = (67)•(.5) = 33.5 in lbs
E ₃ = E ₁ + E ₂	Rs = 7 inches	E ₃ = 11.7 + 33.5 = 45.2 in lbs
E ₄ = (E ₃)•(C)	C = 1,500/hour	E ₄ = (45.2)•(1,500) = 67,800 in lbs/h
We = E ₃ / (0.186)•(V ²)	s = .5 inches	We = 45.2 / (1.1 ²) = 200.8 lbs

*Force is approximate

R10 - Select from Model Rating Chart: MC 150H

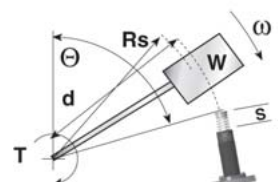

1 Shock Absorbers for Pneumatic Cylinders

- For:
- optimum deceleration
 - higher speeds
 - smaller cylinders
 - reduced air consumption
 - smaller valves and pipework

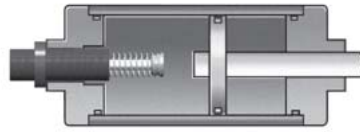

With heavy loads or high velocities normal cylinder cushions are often overloaded. This causes shock loading leading to premature cylinder failure or excessive maintenance. Using oversized cylinders to withstand this shock loading is not the best solution since this considerably increases air consumption and costs.

Example: MA 3350 M-Z
 -Z = cylinder mounting

2 Side Load Adapter for High Side Load Angles

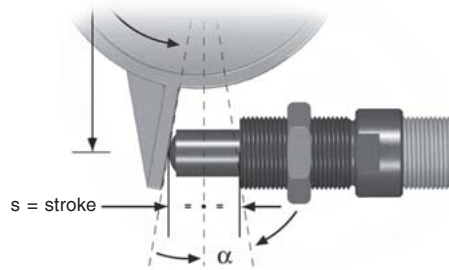

The side loading is removed from the shock absorber piston rod leading to considerably longer life. Wherever possible mount shock absorber so that impacting face is perpendicular to shock absorber axis half way through stroke. See [pages 48](#) and [49](#) for more details.

3 Undamped Free Travel with Damped End Extension

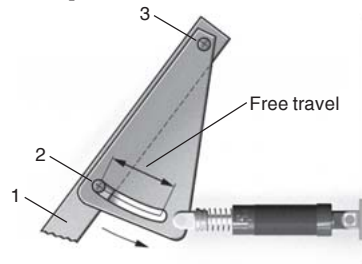

The lever 1 swings with the pin 2 in a slotted hole around pivot point 3. The lever is smoothly decelerated at the extreme end of its travel.

4 One Shock Absorber for Both Ends of Travel

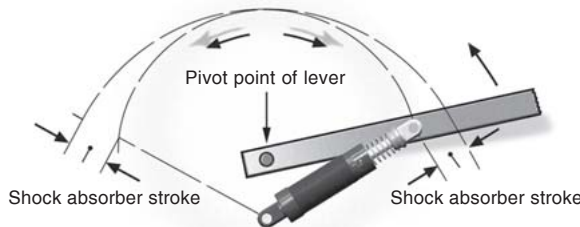

It is possible to use only one shock absorber for both end positions by using different pivot points as shown.

Tip: Leave approx. 0.06 in (1.5 mm) of shock absorber stroke free at each end of travel.

5 Double Acting Shock Absorber

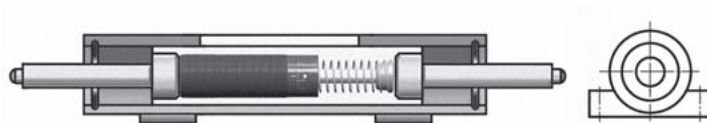

With a little additional work a normal unidirectional shock absorber can be converted to work in 2 directions by using a mechanism as shown.

6 Air Bleed Collar

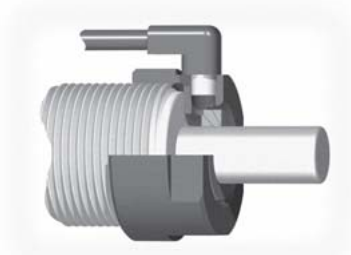

By using this air bleed collar the operating lifetime of shock absorbers in aggressive environments can be considerably increased. The adapter protects the shock absorber seals from cutting fluids, cleaning agents, cooking oils etc. by using a low pressure air bleed.

Available for select shock absorbers.

7 Double Stroke Length

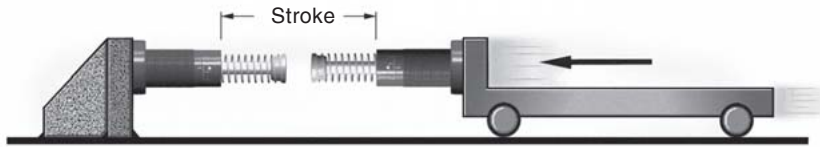

50% lower reaction force (Q) 50% lower deceleration (a)

By driving 2 shock absorbers against one another 'nose-to-nose', the effective stroke length can be doubled.

8 Ride Over Latch

8.1



8.2

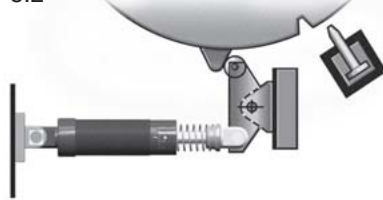

8.1 The latch absorbs the kinetic energy so that the object contacts the fixed stop gently.

8.2 The latch absorbs the rotational energy of the turntable etc. The turntable can then be held in the datum position with a lock bolt or similar device.

9 Rotary Actuator or Rack and Pinion Drive

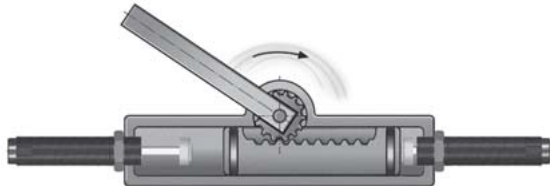

The use of shock absorbers allows higher operating speeds and weights as well as protecting the drive mechanism and housing from shock loads.

10 Adjustable Stop Clamp e.g. for Handling Equipment

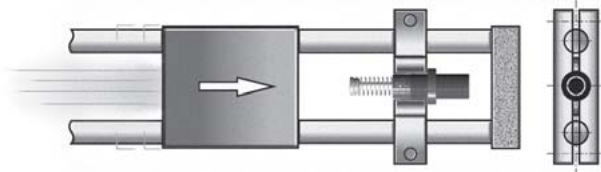

The gentle deceleration of shock absorbers makes the use of adjustable stop clamps possible and removes any chance of the clamp slipping. The kinetic energy is completely removed before the mechanical stop is reached thus making high index speeds possible.

11 Ride-Over Latch e.g. Fire Door

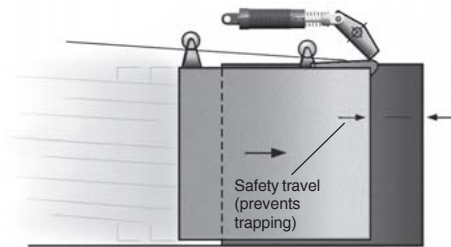

The fire door travels quickly until it reaches the lever. It is then gently decelerated by the lever mounted shock absorber and closes without shock or danger to personnel.

12 Increasing Stroke Length Mechanically

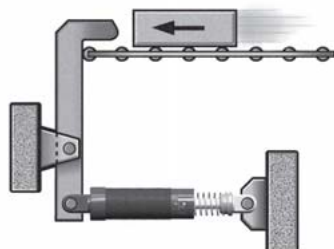

By means of a lever the effective stroke length can be increased and mounting space to the left reduced.

Industrial Shock Absorbers are rated by capacity for the purpose of selecting the proper unit for an application's energy requirements. Ratings are determined by the effective weight that the shock absorber can stop and the energy it can absorb per cycle and per hour. These ratings relate to the mechanical and thermal capacity of a shock absorber because the mechanical energy is converted to heat and dissipated.

Self-Compensating Models

Model Number	Stroke inches 1 inch = 25.4 mm	E3 Max Energy per Cycle, inch lbs 1 in lb = .11 Nm	We Effective Weight lbs, 1 lb = .45 kg	E4 Max Energy per hour, in lbs/hour 1 in lb/hour = .11 Nm/hour			Product Catalog Page
				Self-Contained	A/O Tank	A/O Re-circulating	
MC 9-1	0.20	9	1.35-7.0	18,000	N/A	N/A	16
MC 9-2	0.20	9	1.75-9.0	18,000	N/A	N/A	16
MC 10L	0.20	4	0.75-6.0	35,000	N/A	N/A	16
MC 10H	0.20	7	1.5-11	35,000	N/A	N/A	16
MC 25L	0.25	20	1.5-5	120,000	N/A	N/A	16
MC 25	0.25	20	4-12	120,000	N/A	N/A	16
MC 25H	0.25	20	10-30	120,000	N/A	N/A	16
MC 75-1	0.40	75	0.5-2.5	250,000	N/A	N/A	16
MC 75-2	0.40	75	2-14	250,000	N/A	N/A	16
MC 75-3	0.40	75	6-80	250,000	N/A	N/A	16
MC 150	0.50	150	2-22	300,000	N/A	N/A	18
MC 150H	0.50	150	20-200	300,000	N/A	N/A	18
MC 150H2	0.50	150	150-450	300,000	N/A	N/A	18
MC 225	0.50	225	5-55	400,000	N/A	N/A	18
MC 225H	0.50	225	50-500	400,000	N/A	N/A	18
MC 225H2	0.50	225	400-2,000	400,000	N/A	N/A	18
MC 600	1.00	600	20-300	600,000	N/A	N/A	18
MC 600H	1.00	600	250-2,500	600,000	N/A	N/A	18
MC 600H2	1.00	600	880-5,000	600,000	N/A	N/A	18
SC 190-1	0.63	225	3-15	300,000	N/A	N/A	20
SC 190-2	0.63	225	8-40	300,000	N/A	N/A	20
SC 190-3	0.63	225	20-100	300,000	N/A	N/A	20
SC 190-4	0.63	225	50-225	300,000	N/A	N/A	20
SC 300-1	0.75	300	3-18	400,000	N/A	N/A	20
SC 300-2	0.75	300	10-60	400,000	N/A	N/A	20
SC 300-3	0.75	300	30-180	400,000	N/A	N/A	20
SC 300-4	0.75	300	70-450	400,000	N/A	N/A	20
SC 300-5	0.59	650	25-100	400,000	N/A	N/A	22
SC 300-6	0.59	650	75-300	400,000	N/A	N/A	22
SC 300-7	0.59	650	200-400	400,000	N/A	N/A	22
SC 300-8	0.59	620	300-1,500	400,000	N/A	N/A	22
SC 300-9	0.59	620	700-4,300	400,000	N/A	N/A	22
SC 650-1	1.00	650	17-100	600,000	N/A	N/A	20
SC 650-2	1.00	650	50-300	600,000	N/A	N/A	20
SC 650-3	1.00	650	150-900	600,000	N/A	N/A	20
SC 650-4	1.00	650	450-2,600	600,000	N/A	N/A	20
SC 650-5	0.91	1,860	50-250	600,000	N/A	N/A	22
SC 650-6	0.91	1,860	200-800	600,000	N/A	N/A	22
SC 650-7	0.91	1,860	700-2,400	600,000	N/A	N/A	22
SC 650-8	0.91	1,860	1,700-5,800	600,000	N/A	N/A	22
SC 650-9	0.91	1,860	4,000-14,000	600,000	N/A	N/A	22
SC 925-1	1.58	975	30-200	800,000	N/A	N/A	20
SC 925-2	1.58	975	90-600	800,000	N/A	N/A	20
SC 925-3	1.58	975	250-1,600	800,000	N/A	N/A	20
SC 925-4	1.58	975	750-4,600	800,000	N/A	N/A	20
MC 3325-1	0.91	1,350	20-80	670,000	1,100,000	1,500,000	26, 28
MC 3325-2			68-272				
MC 3325-3			230-920				
MC 3325-4			780-3,120				
MC 3350-1	1.91	2,700	40-160	760,000	1,200,000	1,600,000	26, 28
MC 3350-2			136-544				
MC 3350-3			460-1,840				
MC 3350-4			1,560-6,240				
MC 3625-1	0.91	1,350	20-80	670,000	1,100,000	1,500,000	26, 28
MC 3625-2			68-272				
MC 3625-3			230-920				
MC 3625-4			780-3,120				
MC 3650-1	1.91	2,700	40-160	760,000	1,200,000	1,600,000	26, 28
MC 3650-2			136-544				
MC 3650-3			460-1,840				
MC 3650-4			1,560-6,240				
MC 4525-1	0.91	3,000	50-200	950,000	1,400,000	1,700,000	26, 30
MC 4525-2			170-680				
MC 4525-3			575-2,300				
MC 4525-4			1,950-7,800				
MC 4550-1	1.91	6,000	100-400	1,000,000	1,700,000	2,200,000	26, 30
MC 4550-2			340-1,360				
MC 4550-3			1,150-4,600				
MC 4550-4			3,900-15,600				
MC 4575-1	2.91	9,000	150-600	1,300,000	2,000,000	2,500,000	22, 30
MC 4575-2			510-2,040				
MC 4575-3			1,730-6,920				
MC 4575-4			5,850-23,400				
MC 6450-1	1.91	15,000	300-1,200	1,300,000	2,600,000	3,400,000	26, 32
MC 6450-2			1,020-4,080				
MC 6450-3			3,460-13,840				
MC 6450-4			11,700-46,800				
MC 64100-1	3.91	30,000	600-2,400	1,700,000	3,400,000	4,400,000	26, 32
MC 64100-2			2,040-8,160				
MC 64100-3			6,920-27,680				
MC 64100-4			23,400-93,600				
MC 64150-1	5.91	45,000	900-3,600	2,200,000	4,400,000	5,700,000	26, 32
MC 64150-2			3,060-12,240				
MC 64150-3			10,380-41,520				
MC 64150-4			35,100-140,400				



Self-Compensating Models Continued

Model Number	Stroke inches 1 inch = 25.4 mm	E3 Max Energy per Cycle, inch lbs 1 in lb = .11 Nm	We Effective Weight lbs, 1 lb = .45 kg	E4 Max Energy per hour, in lbs/hour 1 in lb/hour = .11 Nm/hour			Product Catalog Page
				Self-Contained	A/O Tank	A/O Re-circulating	
CA 2x2-1 CA 2x2-2 CA 2x2-3 CA 2x2-4	2.00	32,000	1,600-4,800 4,000-12,000 10,000-30,000 25,000-75,000	9,600,000	12,000,000	15,600,000	38, 40
CA 2x4-1 CA 2x4-2 CA 2x4-3 CA 2x4-4	4.00	64,000	3,200-9,600 8,000-24,000 20,000-60,000 50,000-150,000	12,000,000	15,000,000	19,500,000	38, 40
CA 2x6-1 CA 2x6-2 CA 2x6-3 CA 2x6-4	6.00	96,000	4,800-14,400 12,000-36,000 30,000-90,000 75,000-225,000	14,400,000	18,000,000	23,500,000	38, 40
CA 2x8-1 CA 2x8-2 CA 2x8-3 CA 2x8-4	8.00	128,000	6,400-19,200 16,000-48,000 40,000-120,000 100,000-300,000	16,800,000	21,000,000	27,000,000	38, 40
CA 2x10-1 CA 2x10-2 CA 2x10-3 CA 2x10-4	10.00	160,000	8,000-24,000 20,000-60,000 50,000-150,000 125,000-375,000	19,200,000	24,000,000	31,000,000	38, 40
CA 3x5-1 CA 3x5-2 CA 3x5-3 CA 3x5-4	5.00	125,000	6,400-19,200 16,000-48,000 40,000-120,000 100,000-300,000	20,000,000	25,000,000	32,500,000	38, 40
CA 3x8-1 CA 3x8-2 CA 3x8-3 CA 3x8-4	8.00	200,000	10,240-30,720 25,600-76,800 64,000-192,000 160,000-480,000	32,000,000	40,000,000	52,000,000	38, 40
CA 3x12-1 CA 3x12-2 CA 3x12-3 CA 3x12-4	12.00	300,000	15,360-46,080 38,400-115,200 96,000-288,000 240,000-720,000	48,000,000	60,000,000	78,000,000	38, 40
CA 4x6-3 CA 4x6-5 CA 4x6-7	6.00 6.00 6.00	420,000 420,000 420,000	8,000-19,000 19,000-41,000 41,000-94,000	27,000,000 27,000,000 27,000,000	45,000,000 45,000,000 45,000,000	58,000,000 58,000,000 58,000,000	38, 44 38, 44 38, 44
CA 4x8-3 CA 4x8-5 CA 4x8-7	8.00 8.00 8.00	560,000 560,000 560,000	11,000-25,000 25,000-55,000 55,000-125,000	30,000,000 30,000,000 30,000,000	50,000,000 50,000,000 50,000,000	65,000,000 65,000,000 65,000,000	38, 44 38, 44 38, 44
CA 4x16-3 CA 4x16-5 CA 4x16-7	16.00 16.00 16.00	1,120,000 1,120,000 1,120,000	22,000-50,000 50,000-110,000 110,000-250,000	50,000,000 50,000,000 50,000,000	85,000,000 85,000,000 85,000,000	110,000,000 110,000,000 110,000,000	38, 44 38, 44 38, 44

Adjustable Models

MA 35	0.40	35	13-125	53,000			24
MA 150	0.50	150	2-200	300,000			24
MA 225	0.75	225	5-500	400,000	N/A	N/A	24
MA 600	1.00	600	20-3,000	600,000			24
MA 900	1.58	900	30-4,500	800,000			24
MA 3325	0.91	1,500	20-3,800	670,000	1,100,000	1,500,000	27
MA 3350	1.91	3,000	28-5,400	760,000	1,200,000	1,600,000	27
MA 3625	0.91	1,500	20-3,800	670,000	1,100,000	1,500,000	27
MA 3650	1.91	3,000	28-5,400	760,000	1,200,000	1,600,000	27
MA 4525	0.91	3,450	95-22,000	950,000	1,400,000	1,700,000	27, 30
MA 4550	1.91	6,900	150-32,000	1,000,000	1,700,000	2,200,000	27, 30
MA 4575	2.91	10,350	155-33,000	1,300,000	2,000,000	2,500,000	27, 30
MA 6450	1.91	18,000	480-110,000	1,300,000	2,600,000	3,400,000	27, 32
MA 64100	3.91	36,000	600-115,000	1,700,000	3,400,000	4,400,000	27, 32
MA 64150	5.91	54,000	730-175,000	2,200,000	4,400,000	5,700,000	27, 32
1-1/2x2	2.00	16,000	430-70,000	3,200,000	4,000,000	5,200,000	36
1-1/2x3-1/2	3.50	28,000	480-80,000	5,600,000	7,000,000	9,100,000	36
1-1/2x5	5.00	40,000	500-90,000	8,000,000	10,000,000	13,000,000	36
1-1/2x6-1/2	6.50	52,000	680-100,000	10,400,000	13,000,000	17,000,000	36
A 2x2	2.00	32,000	560-170,000	9,600,000	12,000,000	15,600,000	39, 40
A 2x4	4.00	80,000	510-160,000	12,000,000	15,000,000	19,500,000	39, 40
A 2x6	6.00	120,000	570-190,000	14,400,000	18,000,000	23,500,000	39, 40
A 2x8	8.00	170,000	580-200,000	16,800,000	21,000,000	27,000,000	39, 40
A 2x10	10.00	210,000	720-250,000	19,200,000	24,000,000	31,000,000	39, 40
A 3x5	5.00	140,000	1,050-340,000	20,000,000	25,000,000	32,500,000	39, 40
A 3x8	8.00	250,000	1,200-400,000	32,000,000	40,000,000	52,000,000	39, 40
A 3x12	12.00	390,000	1,350-450,000	48,000,000	60,000,000	78,000,000	39, 40

Low Velocity Adjustable Models

ML 3325	0.91	1,500	.05-1.5	670,000	1,100,000	1,500,000	27
ML 3350	1.91	3,000	.05-1.5	760,000	1,200,000	1,600,000	27
ML 3625	0.91	1,500	.05-1.5	670,000	1,100,000	1,500,000	27
ML 3650	1.91	3,000	.05-1.5	760,000	1,200,000	1,600,000	27
ML 4525	0.91	3,450	.05-1.5	950,000	1,400,000	1,700,000	27, 30
ML 4550	1.91	6,900	.05-1.5	1,000,000	1,700,000	2,200,000	27, 30
ML 6425	0.91	9,000	.05-1.5	1,100,000	2,200,000	2,900,000	27, 32
ML 6450	1.91	18,000	.05-1.5	1,300,000	2,600,000	3,400,000	27, 32



Miniature Shock Absorbers MC 9 to MC 75
Self-Compensating



Miniature Shock Absorbers

are self-contained hydraulic units. The MC 9 to MC 75 model range has a very short overall length and low return force. Its small size allows for high energy absorption in confined spaces, while the wide effective weight ranges accommodate a variety of load conditions. With threaded outer bodies and multiple accessories, MC models can be mounted in numerous configurations.

Applications include: small linear slides, material handling and packaging equipment, small robotics, office and medical equipment, as well as instrumentation.

Ordering Information

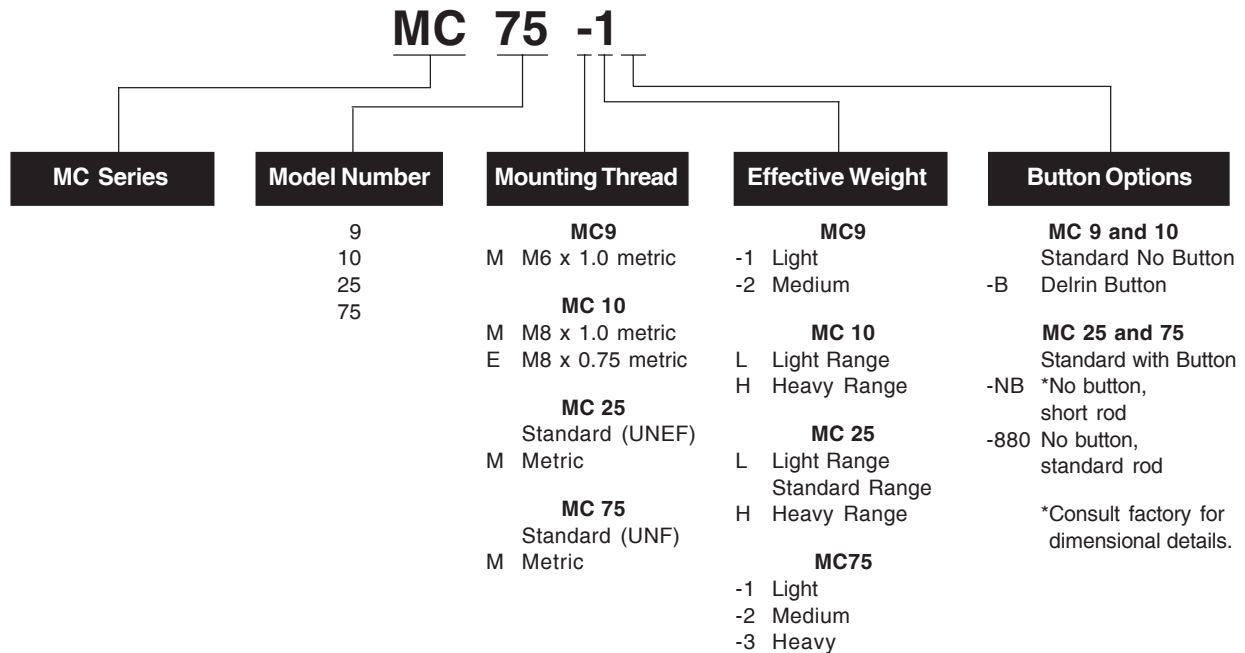

Miniature Shock Absorbers MC 9 to MC 75
Self-Compensating

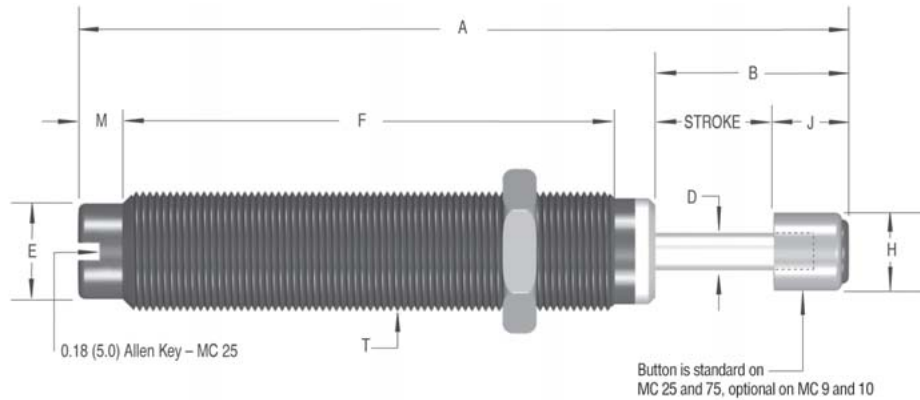

Dimensions IN INCHES (MILLIMETERS)													
Model	Stroke	A	B	C	D	E	F	H	J	M	T	EE	FF
MC 9M	.20 (5.0)	1.42 (36.0)	.40 (10.0)	N/A	.08 (2.0)	.20 (5.0)	.83 (21.1)	.19 (4.7)	.20 (5.0)	.10 (2.5)	M6x0.5	N/A	N/A
MC 10E MC 10M	.20 (5.0)	1.52 (38.6)	.40 (10.0)	N/A	.08 (2.0)	.25 (6.4)	.83 (21.1)	.19 (4.7)	.20 (5.0)	.19 (4.8)	M8x0.75 M8x1	N/A	N/A
MC 25 MC 25M	.26 (6.6)	2.27 (57.7)	.57 (14.5)	N/A	.13 (3.3)	.33 (8.4)	1.3 (33.0)	.30 (7.6)	.32 (8.1)	.20 (5.0)	3/8-32 UNEF M10x1	N/A	N/A
MC 75 MC 75M	.40 (10.2)	2.76 (70.1)	.72 (18.1)	N/A	.13 (3.3)	.41 (10.4)	1.74 (44.2)	.30 (7.6)	.32 (8.1)	.18 (4.6)	1/2-20 UNF M12x1	N/A	N/A

Specifications							
Model	We Effective Weight lbs (kg)		E ₃ Energy per Cycle in lbs (Nm)	E ₄ Energy per Hour in lbs/hour (Nm/hour)	Return Force lbs (N)	Return Time sec	Shipping Weight lbs (kg)
MC 9M-1 MC 9M-2	1.35 - 7.0 1.75 - 9.0	(0.6 - 3.2) (0.8 - 4.1)	9.0 (1.0)	18,000 (2,000)	0.31 - 0.85 (1.38-3.78)	0.30	0.01 (0.004)
MC 10L MC 10H	0.75 - 6.0 1.5 - 11	(0.34 - 3) (0.68 - 5)	4.0 (0.45) 7.0 (0.79)	35,000 (3,950)	0.5 - 1.0 (2.22 - 4.45)	0.20	.02 (0.01)
MC 25L MC 25 MC 25H	1.5 - 5.0 4 - 12 10 - 30	(0.70 - 2) (2 - 5) (5 - 14)	20 (2)	120,000 (13,550)	0.8 - 1.7 (3.56 - 7.56)	0.20	.06 (0.03)
MC 75-1 MC 75-2 MC 75-3	.5 - 2.5 2 - 14 6 - 80	(0.23 - 1) (0.91 - 6) (3 - 36)	75 (8)	250,000 (28,240)	1.0 - 2.5 (4.45 - 11.12)	0.30	.09 (0.04)

Technical Data

Impact velocity range:

- MC 9: 0.5 to 6 ft/sec (0.15 to 1.8 m/sec)
- MC 10: 0.5 to 5 ft/sec (0.15 to 1.5 m/sec)
- MC 25: 0.5 to 8 ft/sec (0.15 to 2.4 m/sec)
- MC 75: 0.5 to 12 ft/sec (0.15 to 3.66 m/sec)

Operating temperature:

- MC 9 and MC 10: 14° to 158°F (-10° to 70°C)
- MC 25: 32° to 150°F (0° to 66°C)
- MC 75: 32° to 150°F (0° to 66°C)

Mechanical stop: Integral mechanical stop built into front of units.

Oil type: Silicone

Materials: Steel body with black oxide finish. Hardened stainless steel piston rod.

Technical data applies to standard and metric threaded models.

Maximum side load depends on application. For additional information contact The Actuator Division.

Lock nut included with each shock absorber.

Note: All dimensions and tolerance values listed in this catalog are nominal and subject to change without notice.

Miniature Shock Absorbers MC 150 to MC 600
Self-Compensating



Miniature Shock Absorbers

MC 150 to MC 600 model range, feature a hermetically sealed rolling diaphragm seal system that provides the highest possible cycle lifetime and an extremely low rod return force. These models can be directly mounted into the end cover of pneumatic cylinders to provide superior damping compared to normal cylinder cushions. Use of the optional stop collar is recommended to provide a positive mechanical stop. By adding the optional side load adapter (metric threaded models only), it is possible to accept side loads up to 25° from the axis.

Applications for the durable MC Series include: material handling, medium robotics, machine tools, pick and place systems, as well as packaging equipment.

Ordering Information

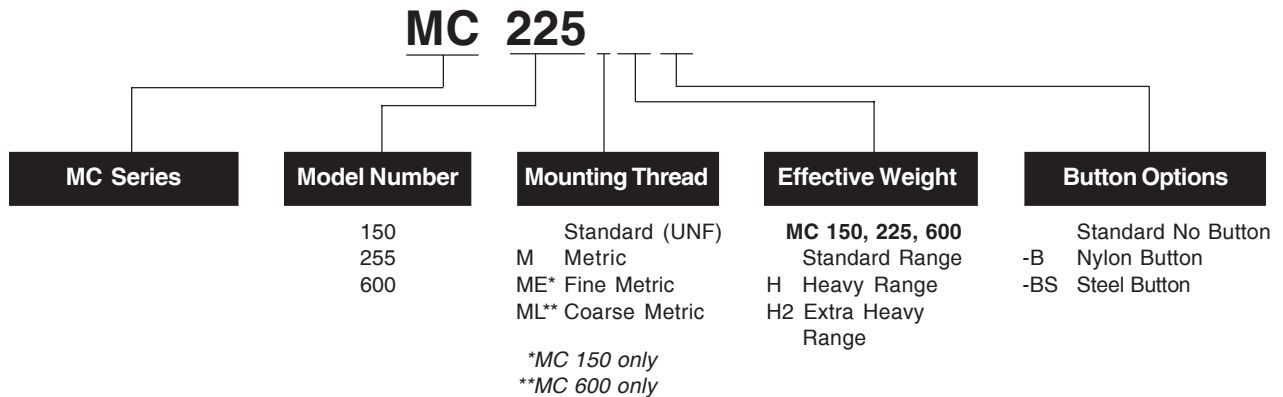

Miniature Shock Absorbers MC 150 to MC 600
Self-Compensating

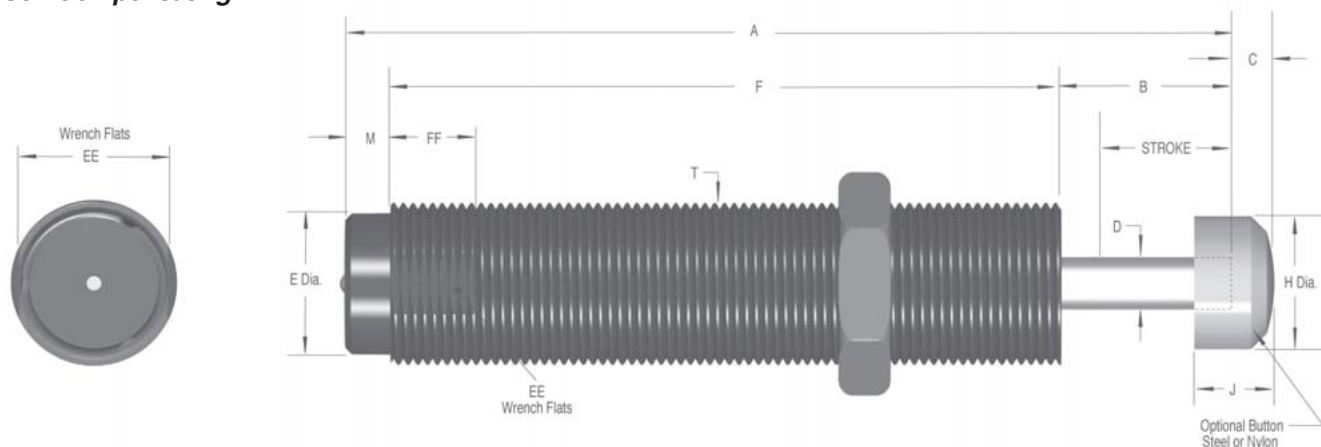

Dimensions IN INCHES (MILLIMETERS)													
Model	Stroke	A	B	C	D	E	F	H	J	M	T	EE	FF
MC 150 MC 150M MC 150ME	.50 (12.8)	3.41 (86.6)	.69 (17.5)	.18 (4.6)	.19 (4.8)	.46 (11.6)	2.44 (62.0)	.47 (11.9)	.39 (9.9)	.28 (7.1)	9/16-18 UNF M14x1.5 M14x1	.500 (12.0)	.50 (12.7)
MC 225 MC 225M MC 225ME	.50 (12.8)	3.81 (96.8)	.69 (17.5)	.16 (4.1)	.25 (6.4)	.66 (16.7)	2.84 (72.1)	.66 (16.8)	.36 (9.1)	.28 (7.1)	3/4-16 UNF M20x1.5 M20x1	.687 (18.0)	.50 (12.7)
MC 600 MC 600M MC 600ML	1.00 (25.4)	5.58 (141.8)	1.24 (31.6)	.23 (5.8)	.31 (7.9)	.87 (22.0)	4.06 (103.1)	.89 (22.6)	.47 (11.9)	.28 (7.1)	1-12 UNF M25x1.5 M27x3	.875 (23.0)	.50 (12.7)

Specifications							
Model	We Effective Weight lbs (kg)		E ₃ Energy per Cycle in lbs (Nm)	E ₄ Energy per Hour in lbs/hour (Nm/hour)	Return Force lbs (N)	Return Time sec	Shipping Weight lbs (kg)
MC 150 MC 150H MC 150H2	2 - 22 20 - 200 150 - 450	(0.91 - 10) (9 - 91) (68 - 204)	150 (17) (280)* (32)*	300,000 (33,890)	0.70 - 1.20 (3.11 - 5.34)	0.40	.12 (0.05)
MC 225 MC 225H MC 225H2	5 - 55 50 - 500 400 - 2,000	(2 - 25) (23 - 227) (181 - 907)	225 (25) (380)* (43)*	400,000 (45,190)	1.00 - 1.50 (4.45 - 6.67)	0.30	.34 (0.15)
MC 600 MC 600H MC 600H2	20 - 300 250 - 2,500 880 - 5,000	(9 - 136) (113 - 1,134) (399 - 2,268)	600 (88) (1,300)* (147)*	600,000 (67,790)	1.00 - 2.00 (4.45 - 8.90)	0.60	.57 (0.26)

*Hydro shock energy ratings. Consult factory.

Technical Data

Impact velocity range: 0.26 to 19.7 ft/sec (0.08 to 6 m/sec)

Operating temperature: 32° to 150°F (0° to 66°C)

Mechanical stop: Must be provided 0.02 to 0.04 inch (0.5 to 1 mm) before end of stroke.

Oil type: Silicone

Materials: Steel body with black oxide finish. Hardened stainless steel piston rod. Rolling seal EPDM (note: seal not compatible with petroleum based fluids) If unit to be used in contact with such fluids specify neoprene rolling seal. Consider the SC² Series as an alternative.

To prevent damage to the rolling seal in MC 150, 225 and 600 models, do not twist or turn the piston rod.

Technical data applies to standard and metric threaded models.

Maximum side load depends on application. For additional information contact The Actuator Division.

Lock nut included with each shock absorber.

Note: MC 150 to MC 600 models may be mounted into pressure chambers of pneumatic actuators.

SC² Series SC 190 to SC 925
Soft Contact and Self-Compensating



SC² Series Miniature Shock Absorbers provide dual performance benefits. They offer **soft contact deceleration** where initial impact reaction forces are very low, with the advantages of **self-compensation** to react to changing energy conditions, without adjustment. They have long stroke lengths, **SC² 925 with 1.58 inch (40 mm) superstroke**, to provide smooth deceleration and low reaction forces.

With the addition of the **optional side load adapter** (SC² 190M, 300M, and 650M models only), SC² Series shock absorbers can handle side loads up to 25°. SC² Series shock absorbers are fully interchangeable with the adjustable MA range.

Applications include: material handling, medium robotics, machine tools, pick and place systems, rodless cylinders and packaging equipment.

Ordering Information

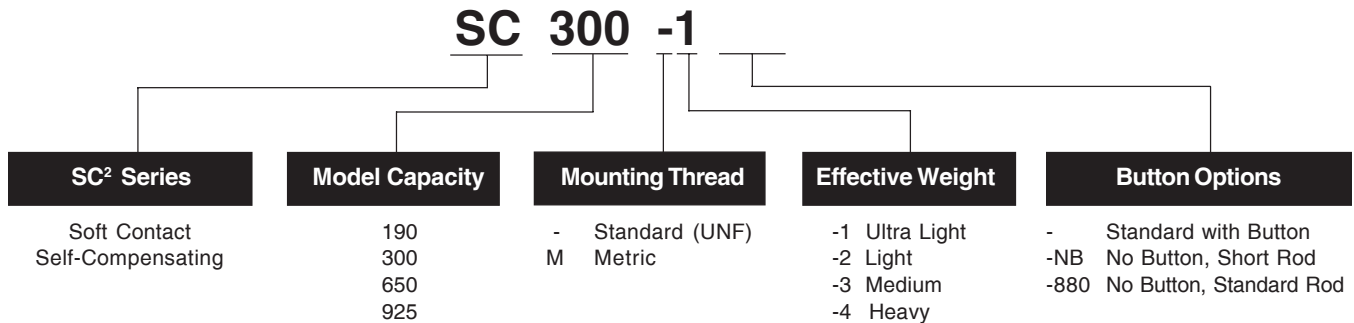

SC² Series SC 190 to SC 925
Soft Contact and Self-Compensating

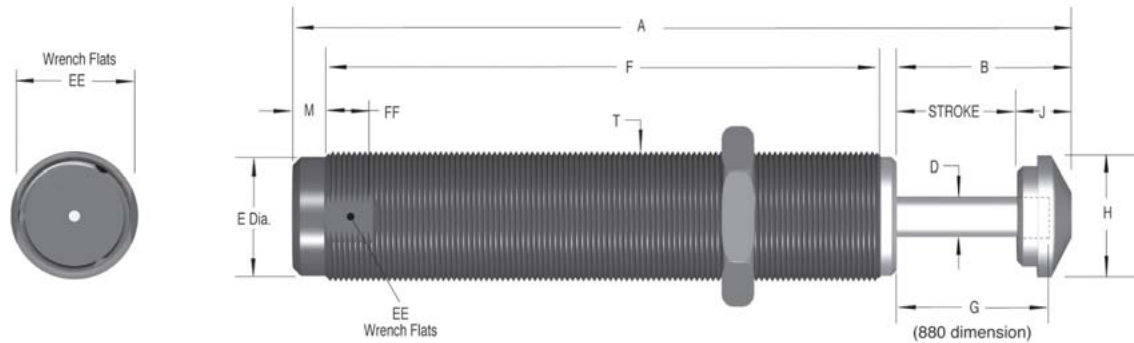

Dimensions IN INCHES (MILLIMETERS)													
Model	Stroke	A	B	D	E	F	G	H	J	M	T	EE	FF
SC 190	.63	4.50	1.06	.16	.46	3.00	.88	.47	.43	.28	9/16-18 UNF	1/2	.50
SC 190M	(16.0)	(114.3)	(26.9)	(4.1)	(11.7)	(76.2)	(22.4)	(11.9)	(11.0)	(7.1)	M14x1.5	(12.0)	(12.7)
SC 300	.75	4.62	1.18	.19	.66	3.09	1.00	.66	.43	.28	3/4-16 UNF	11/16	.50
SC 300M	(19.1)	(117.5)	(30.0)	(4.8)	(16.8)	(78.5)	(25.4)	(16.8)	(11.0)	(7.1)	M20x1.5	(18.0)	(12.7)
SC 650	1.00	5.62	1.43	.25	.87	3.83	1.25	.90	.43	.28	1-12 UNF	7/8	.50
SC 650M	(25.4)	(142.6)	(36.3)	(6.3)	(22.1)	(97.3)	(31.8)	(22.9)	(11.0)	(7.1)	M25x1.5	(23.0)	(12.7)
SC 925	1.58	7.44	2.01	.25	.87	5.1	1.82	.90	.43	.28	1-12 UNF	7/8	.50
SC 925M	(40.0)	(189.1)	(51.1)	(6.3)	(22.1)	(129.5)	(46.4)	(22.9)	(11.0)	(7.1)	M25x1.5	(23.0)	(12.7)

Specifications							
Model	Soft Contact We Effective Weight lbs (kg)	Self-Compensating We Effective Weight lbs (kg)	E3 Energy per Cycle in lbs (Nm)	E4 Energy per Hour in lbs/hour (Nm/hour)	Return Force lbs (N)	Return Time sec	Shipping Weight lbs (kg)
SC 190-1	5 - 13 (2 - 6)	3 - 15 (1.4 - 7)					
SC 190-2	12 - 38 (5 - 18)	8 - 40 (4 - 18)	225 (25)	300,000	0.90 - 1.90	0.25	0.18
SC 190-3	30 - 90 (14 - 41)	20 - 100 (9 - 45)	*300 (33)	(34,000)	(4.00 - 8.95)		(0.08)
SC 190-4	75 - 200 (34 - 91)	50 - 225 (23 - 102)					
SC 300-1	5 - 15 (2 - 7)	3 - 18 (1.4 - 8)					
SC 300-2	15 - 50 (7 - 23)	10 - 60 (5 - 27)	300 (33)	400,000	1.05 - 2.15	0.10	0.25
SC 300-3	50 - 150 (23 - 68)	30 - 180 (14 - 82)	*500 (56)	(45,000)	(4.67 - 9.56)		(0.11)
SC 300-4	150 - 400 (68 - 181)	70 - 450 (32 - 204)					
SC 650-1	24 - 80 (11 - 36)	17 - 100 (8 - 45)					
SC 650-2	75 - 250 (34 - 113)	50 - 300 (23 - 136)	650 (73)	600,000	2.40 - 6.87	0.20	0.67
SC 650-3	240 - 800 (109 - 363)	150 - 900 (68 - 408)	*1,000 (113)	(68,000)	(10.67 - 30.55)		(0.31)
SC 650-4	800 - 2400 (363 - 1089)	450 - 2600 (204 - 1180)					
SC 925-1	50 - 160 (22 - 72)	30 - 200 (14 - 90)					
SC 925-2	130 - 460 (59 - 208)	90 - 600 (40 - 272)	975 (110)	800,000	2.40 - 7.40	0.40	0.87
SC 925-3	400 - 1,350 (181 - 612)	250 - 1,600 (113 - 726)	*1,700 (192)	(90,000)	(10.67 - 30.55)		(0.39)
SC 925-4	1200 - 4300 (544 - 1952)	750 - 4600 (340 - 2088)					

Technical Data

Impact velocity range: 0.5 to 12 ft/sec (0.15 to 3.66 m/sec)

Operating temperature: 32° to 150°F (0° to 66°C)

Mechanical stop: Integral mechanical stop built into front of units.

Oil type: #5

Materials: Steel body with black oxide finish. Hardened stainless steel piston rod.

Technical data applies to standard and metric threaded models.

Maximum side load depends on application. For additional information contact The Actuator Division.

Lock nut included with each shock absorber.

SC² Heavyweight Series SC 300 to SC 650
Soft Contact and Self-Compensating



SC² 300 and SC² 650 Heavyweight Series Shock Absorbers deliver up to **950% of the effective weight capacity** and **280% of the energy absorption capability** of standard models. These durable units are ideal for decelerating heavy weights moving at low velocities. The Heavyweight Series design combines the piston and the inner tube into a single component, the piston tube. It acts as both the pressure creating and pressure controlling device.

SC² 300 and SC² 650 Heavyweight II Series Shock Absorbers offer effective weight ranges and dramatic increases in energy absorption capability, for handling a wider range of applications.

These revolutionary shock absorbers provide dual performance benefits. They offer **soft contact** deceleration where initial impact reaction forces are very low with the advantages of **self-compensation** to cope with changing input energy conditions without adjustment.

Applications include: rotary actuators, rodless cylinders, conveyors, pick and place operations, slides as well as operations turning heavy weights at slow speeds.

Ordering Information

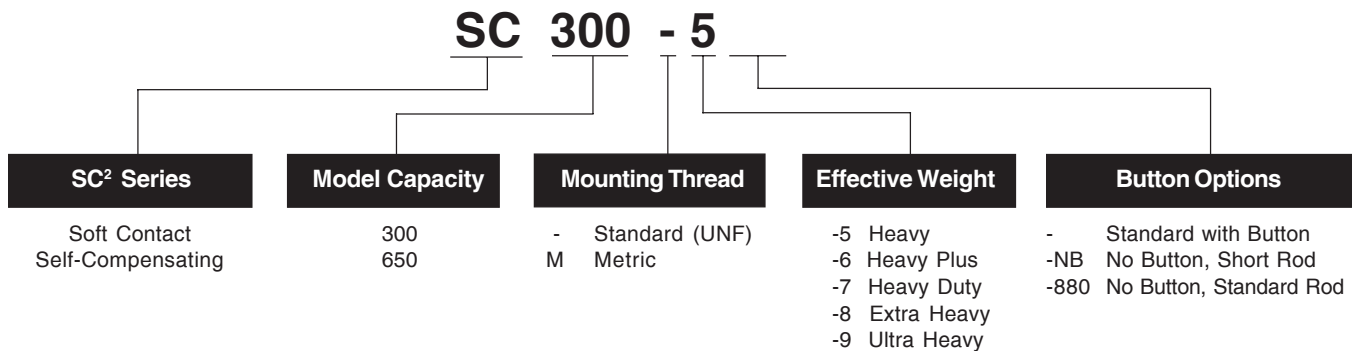

SC² Series SC 190 to SC 925
Soft Contact and Self-Compensating

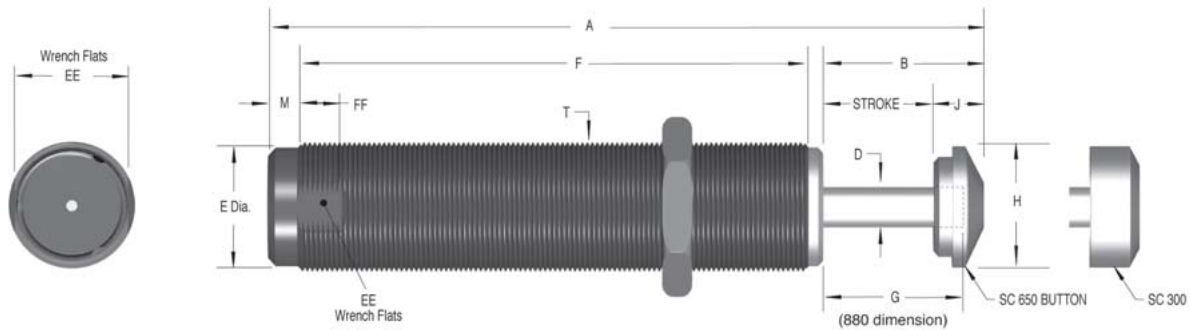

Heavyweight Series Dimensions IN INCHES (MILLIMETERS)													
Model	Stroke	A	B	D	E	F	G	H	J	M	T	EE	FF
SC 300-5													
SC 300-6													
SC 300-7													
SC 300-8													
SC 300-9	.59	4.15	1.02	.25	.66	2.78	.84	.67	.43	.28	3/4-16 UNF	11/16	.50
SC 300M-5	(15.0)	(105.4)	(25.9)	(6.4)	(16.8)	(70.6)	(21.3)	(17.0)	(11.0)	(7.1)	M20x1.5	(17.5)	(12.7)
SC 300M-6													
SC 300M-7													
SC 300M-8													
SC 300M-9													
SC 650-5													
SC 650-6													
SC 650-7													
SC 650-8													
SC 650-9	.91	5.51	1.33	.38	.87	3.83	1.16	.88	.43	.28	1-12 UNF	7/8	.50
SC 650M-5	(23.1)	(140.0)	(33.8)	(9.6)	(22.1)	(97.3)	(29.5)	(22.4)	(11.0)	(7.1)	M25x1.5	(22.2)	(12.7)
SC 650M-6													
SC 650M-7													
SC 650M-8													
SC 650M-9													

Specifications							
Model	Soft Contact We Effective Weight lbs (kg)	Self-Compensating We Effective Weight lbs (kg)	E3 Energy per Cycle in lbs (Nm)	E4 Energy per Hour in lbs/hour (Nm/hour)	Return Force lbs (N)	Return Time sec	Shipping Weight lbs (kg)
SC 300-5	38 - 90 (17 - 41)	25 - 100 (11 - 45)	650 (73)	400,000 (45,194)	1.70 - 4.00 (7.56 - 17.79)	0.20	0.33 (0.15)
SC 300-6	115 - 270 (52 - 123)	75 - 300 (34 - 136)					
SC 300-7	300 - 360 (136 - 163)	200 - 400 (91 - 181)					
SC 300-8	450 - 1,350 (204 - 612)	300 - 1,500 (136 - 680)	620 (70)	400,000 (45,194)	1.70 - 4.00 (7.56 - 17.79)	0.20	0.33 (0.15)
SC 300-9	1,050 - 3,900 (476 - 1,769)	700 - 4,300 (318 - 1,950)					
SC 650-5	75 - 225 (34 - 102)	50 - 250 (23 - 113)	1,860 (210)	600,000 (67,791)	2.40 - 7.30 (10.68 - 32.99)	0.30	0.76 (0.34)
SC 650-6	300 - 720 (136 - 327)	200 - 800 (91 - 363)					
SC 650-7	1,050 - 2,150 (476 - 975)	700 - 2,400 (317 - 1,089)					
SC 650-8	2,500 - 5,200 (1,134 - 2,359)	1,700 - 5,800 (771 - 2,631)	1,860 (210)	600,000 (67,791)	2.40 - 7.30 (10.68 - 32.47)	0.30	0.76 (0.34)
SC 650-9	6,000 - 12,500 (2,722 - 5,670)	4,000 - 14,000 (1,814 - 6,350)					

Technical Data

Impact velocity range: .30 to 12.0 ft/sec (0.09 to 3.66 m/sec)

Operating temperature: 32° to 150°F (0° to 66°C)

Mechanical stop: Integral mechanical stop built into front of units.

Oil type: #5

Materials: Steel body with black oxide finish. Hardened stainless steel piston rod.

Technical data applies to standard and metric threaded models.

Maximum side load depends on application. For additional information contact The Actuator Division.

Lock nut included with each shock absorber.

Miniature Shock Absorbers MA 35 to MA 900
Adjustable



MA Series miniature shock absorbers offer a compact design with true linear deceleration, and are adjustable over a wide range of conditions. If your preference is a fully adjustable shock absorber rather than a self-compensating model on your application, then the MA Series provides a directly interchangeable alternative.

These adjustable models feature long stroke lengths, **MA 900 with 1.58 inch (40 mm) superstroke**, to provide smooth deceleration and low reaction forces. The MA 150 incorporates the proven rolling diaphragm seal (used on the MC 150 to MC 600 range) and shares all the advantages of that technology.

Applications include: material handling, medium robotics, pick and place systems, machine tool and packaging equipment.

Ordering Information

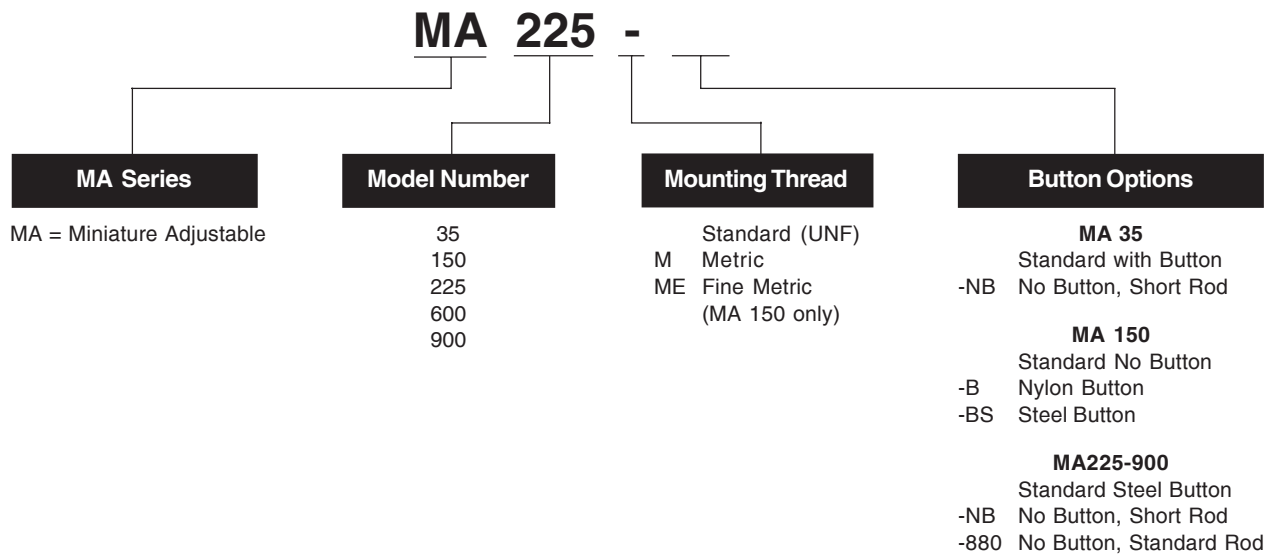

Miniature Shock Absorbers MA 35 to MA 900

Adjustable

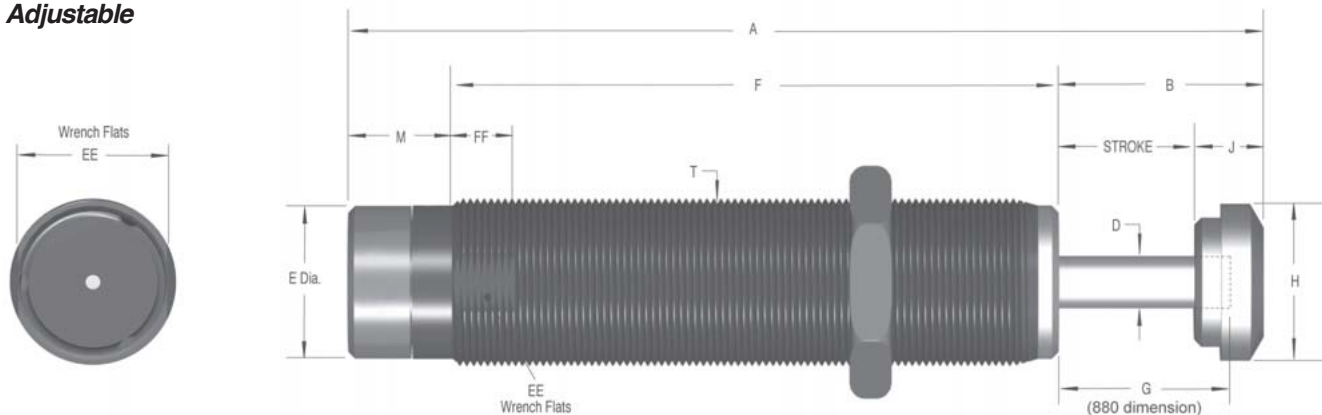

Dimensions		IN INCHES (MILLIMETERS)											
Model	Stroke	A	B	D	E	F	G	H	J	M	T	EE	FF
MA 35 MA 35M	.40 (10.1)	3.31 (84.1)	.72 (18.3)	.13 (3.3)	.42 (10.6)	2.41 (61.2)	N/A	.30 (7.6)	.32 (8.0)	.18 (4.6)	1/2-20 UNF M12x1	N/A	N/A
MA 150 MA 150M MA 150ME	.49 (12.4)	3.64 (92.5)	.92 (23.4)	.19 (4.8)	.46 (11.6)	2.44 (62.0)	.69 (17.5)	.47 (11.9)	.43 (11.0)	.28 (7.1)	9/16 -18 UNF M14x1.5 M14x1	.49 (12.7)	.50 (12.7)
MA 225 MA 225M	.75 (19.1)	4.67 (118.6)	1.18 (30.0)	.19 (4.8)	.66 (16.8)	2.94 (74.7)	1.00 (25.3)	.66 (16.8)	.43 (11.0)	.55 (14.0)	3/4-16 UNF M20x1.5	11/16 (18.0)	.50 (12.7)
MA 600 MA 600M	1.00 (25.4)	5.62 (142.6)	1.43 (36.3)	.25 (6.3)	.88 (22.4)	3.54 (90.0)	1.25 (31.8)	.90 (22.9)	.43 (11.0)	.65 (16.5)	1-12 UNF M25x1.5	7/8 (23.0)	.50 (12.7)
MA 900 MA 900M	1.58 (40.0)	7.44 (189.0)	2.01 (51.1)	.25 (6.3)	.88 (22.4)	4.78 (121.4)	1.85 (46.4)	.90 (22.9)	.43 (11.0)	.65 (16.5)	1-12 UNF M25x1.5	7/8 (23.0)	.50 (12.7)

Specifications							
Model	We Effective Weight lbs (kg)	E ₃ Energy per Cycle in lbs (Nm)	E ₄ Energy per Hour in lbs/hour (Nm/hour)	Return Force lbs (N)	Return Time sec	Shipping Weight lbs (kg)	
MA 35	13 - 125 (6 - 57)	35 (4)	53,000 (5,988)	1.20 - 2.60 (5.33 - 11.56)	.17	.10 (0.04)	
MA 150	2 - 200 (0.91 - 91)	150 (17)	300,000 (33,890)	0.70 - 1.20 (3.12 - 5.34)	.40	.12 (0.05)	
MA 225	5 - 500 (2 - 227)	225 (25)	400,000 (45,190)	1.05 - 2.15 (4.67 - 9.56)	.10	.28 (0.13)	
MA 600	20 - 3,000 (9 - 1,361)	600 (68)	600,000 (67,790)	2.40 - 6.87 (10.67 - 30.56)	.20	.67 (0.30)	
MA 900	30 - 4,500 (14 - 2,041)	900 (102)	800,000 (90,380)	2.40 - 7.40 (10.67 - 32.92)	.40	.87 (0.39)	

Technical Data

Impact velocity range

MA 35: 3.3 ft/sec (1.0 m/sec)

MA 150, 225, 600, 900: 0.5 to 12 ft/sec (0.15 to 3.66 m/sec)

Operating Temperature: 32° to 150°F (0° to 66°C)

Mechanical Stop

MA 35: Integral

MA 150: Must be provided 0.02 to 0.04 inch (0.5 to 1 mm) before end of each stroke.

MA 225, 600, 900: Integral mechanical stop built into front of units.

Oil type

MA 35: #5

MA 150: Silicone

MA 225, 600, 900: ATF

Materials: Steel body with black oxide finish. Hardened stainless steel piston rod.

Adjustment: On models MA 35 up to MA 150: by turning the adjustment screw at rear. On the larger sizes: by turning the adjustment knob against the scale marked 0 to 9. After installation, cycle the machine a few times and turn the adjustment knob until optimum deceleration is achieved (i.e. smooth deceleration throughout stroke).

Hard impact at start of stroke-turn adjuster toward 9.

Hard set-down at end of stroke-turn adjuster toward 0.

Technical data applies to standard and metric threaded models.

Maximum side load depends on application. For additional information contact The Actuator Division.

Note: MA 150 models may be mounted into pressure chambers of pneumatic actuators.

Lock nut included with each shock absorber.

MA 35 and MA 150 models can be utilized as velocity controls.



Magnum Series MC 33 to MC 64
Self-Compensating



Parker presents the ultimate in industrial shock absorber design...the Magnum Series.

These versatile performers offer you the capability to mount shock absorbers that contain the highest energy capacity ratings in the industry. **Up to 150% of the energy per cycle** of previous models in the same package size, means increased safety factors in a wider range of applications.

Up to 390% of the effective weight capacity of previous models, may allow a smaller, lower priced shock absorber to be mounted, to meet your application requirements.

All Magnum Series shock absorbers are **fully threaded** for ease of installation. **Incorporation of high strength materials** along with an **integral stop collar** translates to extended shock absorber life and cost savings for you.

Applications include: automotive manufacturing and production equipment, large robotics, heavy conveyors, packaging and glass bottling equipment, rotary actuators, theme park rides, and lumber industry equipment.

Technical Data

Impact velocity range:

MC Models: 0.5 to 16.5 ft/sec (0.15 to 5 m/sec)

Operating Temperature: 10° to 150°F (-12° to 66°C)

Oil type: ATF

Materials: Steel with black oxide finish. Piston rod high tensile steel, hardened and chrome plated. Rod end button hardened steel with black oxide finish. Zinc plated return spring. For optimum heat dissipation, **do not** paint shock absorber.

Technical data applies to standard and metric threaded models.

Lock nut included with each shock absorber.

Magnum Series MA and ML 33 to 64
Adjustable

Magnum Series adjustable shock absorbers feature the latest seal technology, a **hardened piston ring, pressure chamber and outer body** for increased operating life. Additionally, these rugged units offer the unique feature of **front or rear adjustment** along with a fully threaded outer body for ease of installation.

Magnum Series adjustable shock absorbers are **directly interchangeable** with obsolete primary series and competitor models.

Along with the self-compensating models, the adjustable range offers unprecedented increases in energy and effective weight capacity.

Applications are the same as self-compensating models.



Technical Data

Impact velocity range

MA Models: 0.5 to 16.5 ft/sec (0.15 to 5 m/sec)

ML Models: 0.06 to 1.5 ft/sec (0.02 to 0.46 m/sec)

Operating Temperature: 10° to 150°F (-12° to 66°C)

Oil type: ATF

Materials: Steel with black oxide finish. Piston rod high tensile steel, hardened and chrome plated. Rod end button hardened steel with black oxide finish. Zinc plated return spring. For optimum heat dissipation, **do not** paint shock absorber.

Adjustment: After installation of the Magnum Series shock absorber, cycle the machine a number of times. Turn the front stop collar or the rear adjuster against the scale marked 0 to 9 until optimum deceleration is achieved (i.e. smooth deceleration throughout the stroke).

Hard impact at start of stroke-turn adjuster toward 9.

Hard set-down at end of stroke-turn adjuster toward 0.

Technical data applies to standard and metric threaded models.

The Actuator Division recommends that side load not exceed 5°. Maximum side load depends on application. For additional information consult The Actuator Division.

Lock nut included with each shock absorber.

Magnum Series MC/MA/ML 33 and 36
Self-Compensating and Adjustable

Primary Mount



Adjuster (MA and ML only)

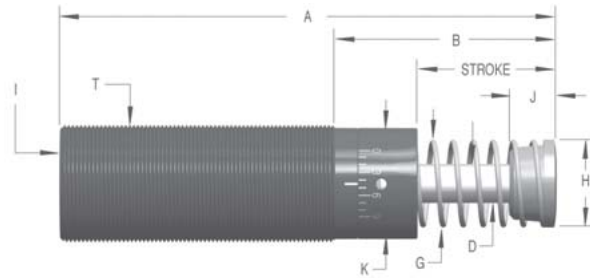

Clevis Mount

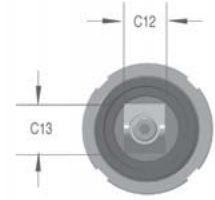
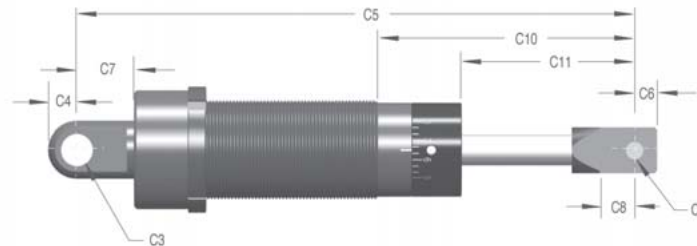
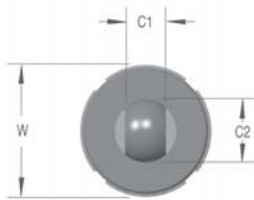

Side-Foot Mount

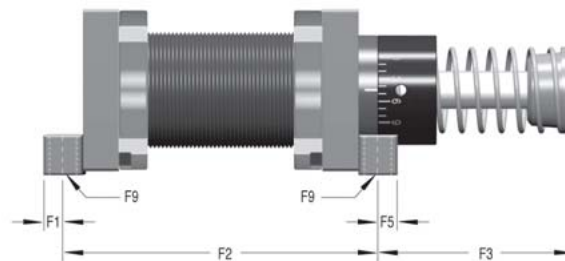
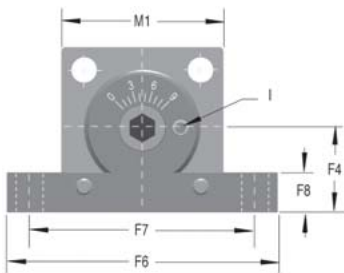

33 Model Dimensions IN INCHES (MILLIMETERS)															
Model	Stroke	A	B	D	G	H	I*	J	K	T	W	C1	C2	C3	C4
MC, MA, ML 3325	0.91 (23.1)	5.44 (138.1)	2.19 (55.6)	0.375 (9.5)	0.99 (25.1)	1.00 (25.4)	1/8 NPT MALE	0.75 (19.1)	1.15 (29.2)	1-1/4-12 M33x1.5	1.50 (38.10)	0.50 (12.7)	0.76 (19.3)	.2505 (6.40)	0.32 (8.1)
MC, MA, ML 3350	1.91 (48.5)	7.44 (189)	3.19 (81)								1.56 (39.71)				
Model	C5	C6	C7	C8	C9	C10	C11	C12	C13	C14	F1	F2	F3	F4	F5
MC, MA, ML 3325	6.58 (167)	0.25 (6.4)	0.48 (12.2)	0.50 (12.7)	.2505 (6.4)	2.64 (67.1)	1.36 (34.5)	0.50 (12.7)	0.75 (19.1)	N/A	0.25 (6.4)	3.75 (95.3)	1.94 (49.3)	0.87 (22.1)	0.25 (6.4)
MC, MA, ML 3350	8.58 (217.8)					3.64 (92.5)	2.36 (60)					4.75 (120.7)	2.94 (74.7)		
Model	F6	F7	F8	F9	* For models MAA and MAS 33 the 1/8-27 male fitting is shipped with the shock. MAA and MAS 45 and 64 have pipe plugs. Note: For models MAA, MLA and MCA indicate P for the side port option when ordering clevis mount.										
MC, MA, ML 3325	2.75 (69.9)	2.37 (60)	0.50 (12.7)	0.23 (5.9)											
MC, MA, ML 3350															

Note: M 36 and 1-3/8 thread is optional.

Note: A side port can be adapted to Magnum Series 33 MAA, MLA and MCA models and is a special adder item. A side port adapter ring is molded onto the outer tube and increases the overall diameter by 0.25 inches (6.3 mm) in the area of the ring. The side port centerline is located 0.81 inches (20.7 mm) from the front of the outer tube. Add (-P) to the model ordering code if a side port is desired, see [page 34](#).

Note: Poly pad available on 33 models only – part no. 250-0011.

Lock nut included with each shock absorber. See [page 51](#) for dimensions.

Note: All dimensions and tolerance values listed in this catalog are nominal and subject to change without prior notice.

**Magnum Series MC/MA/ML 33 and 36
Self-Compensating and Adjustable**

36 Model Dimensions IN INCHES (MILLIMETERS)															
Model	Stroke	A	B	D	G	H	I*	J	K	T	W	C1	C2	C3	C4
MC, MA, ML 3625	0.91 (23.1)	5.44 (138.1)	2.19 (55.6)	0.375 (9.5)	0.99 (25.1)	1.00 (25.4)	1/8 NPT MALE	0.75 (19.1)	1.15 (29.2)	1-3/8-12 M36x1.5	1.75 (44.5)	N/A	N/A	N/A	N/A
MC, MA, ML 3650	1.91 (48.5)	7.44 (189)	3.19 (81)												
Model	C5	C6	C7	C8	C9	C10	C11	C12	C13	C14	F1	F2	F3	F4	F5
MC, MA, ML 3625	N/A	N/A	N/A	N/A	N/A	N/A	N/A	N/A	N/A	N/A	N/A	N/A	N/A	N/A	N/A
MC, MA, ML 3650	N/A	N/A	N/A	N/A	N/A	N/A	N/A	N/A	N/A	N/A	N/A	N/A	N/A	N/A	N/A
Model	F6	F7	F8	F9											
MC, MA, ML 3625	N/A	N/A	N/A	N/A											
MC, MA, ML 3650	N/A	N/A	N/A	N/A											

Specifications...MC Series, Self-Compensating									
Model	We Effective Weight lbs (kg)		E3 Energy per Cycle in lbs (Nm)	Energy per Hour in lbs/hour (Nm/hour)			Return Force lbs (N)	Return Time sec	Shipping Weight lbs (kg)
				E4					
				Internal Accumulator (Self-Contained)	External Accumulator (A/O Tank)	External Accumulator (Re-circulating)			
MC 3325-1	20-80	(9-36)	1,350 (153)	670,000 (75,000)	1,100,000 (124,000)	1,500,000 (169,000)	10.3-19.8 (46-88)	0.03	1.00 (0.45)
MC 3325-2	68-272	(31-123)							
MC 3325-3	230-920	(104-417)							
MC 3325-4	780-3,120	(354-1,415)							
MC 3350-1	40-160	(18-73)	2,700 (305)	760,000 (85,000)	1,200,000 (135,000)	1,600,000 (180,000)	9.9-30.3 (44-135)	0.06	1.2 (0.54)
MC 3350-2	136-544	(62-247)							
MC 3350-3	460-1,840	(209-835)							
MC 3350-4	1,560-6,240	(708-2,830)							
MC 3625-1	20-80	(9-36)	1,350 (153)	670,000 (75,000)	1,100,000 (124,000)	1,500,000 (169,000)	10.3-19.8 (46-88)	0.03	1.23 (0.56)
MC 3625-2	68-272	(31-123)							
MC 3625-3	230-920	(104-417)							
MC 3625-4	780-3,120	(354-1,415)							
MC 3650-1	40-160	(18-73)	2,700 (305)	760,000 (85,000)	1,200,000 (135,000)	1,600,000 (180,000)	9.9-30.3 (44-135)	0.06	1.51 (0.68)
MC 3650-2	136-544	(62-247)							
MC 3650-3	460-1,840	(209-835)							
MC 3650-4	1,560-6,240	(708-2,830)							

Impact velocity range: 0.5 to 16.5 ft/sec (0.15 to 5 m/sec)

Specifications...MA Series, Adjustable															
Model	Stroke	A	B	D	G	H	I*	J	K	T	W	C1	C2	C3	C4
MA 3325	20-3,800	(9-1,724)	1,500 (169)	670,000 (75,000)	1,100,000 (124,000)	1,500,000 (169,000)	10.3-19.8 (46-88)	0.03	1.0 (0.45)						
MA 3350	28-5,400	(13-2,449)	3,000 (339)	760,000 (85,000)	1,200,000 (135,000)	1,600,000 (180,000)	9.9-30.3 (44-135)	0.06	1.2 (0.54)						
MA 3625	20-3,800	(9-1,724)	1,500 (169)	670,000 (75,000)	1,100,000 (124,000)	1,500,000 (169,000)	10.3-19.8 (46-88)	0.03	1.23 (0.56)						
MA 3650	28-5,400	(13-2,449)	3,000 (339)	760,000 (85,000)	1,200,000 (135,000)	1,600,000 (180,000)	9.9-30.3 (44-135)	0.06	1.51 (0.68)						

Impact velocity range: 0.5 to 16.5 ft/sec (0.15 to 5 m/sec)

Specifications...ML Series, Low Velocity Adjustable															
Model	Stroke	A	B	D	G	H	I*	J	K	T	W	C1	C2	C3	C4
ML 3325			1,500 (169)	670,000 (75,000)	1,100,000 (124,000)	1,500,000 (169,000)	10.3-19.8 (46-88)	0.03	1.0 (0.45)						
ML 3350			3,000 (339)	760,000 (85,000)	1,200,000 (135,000)	1,600,000 (180,000)	9.9-30.3 (44-135)	0.06	1.2 (0.54)						
ML 3625			1,500 (169)	670,000 (75,000)	1,100,000 (124,000)	1,500,000 (169,000)	10.3-19.8 (46-88)	0.03	1.23 (0.56)						
ML 3650			3,000 (339)	760,000 (85,000)	1,200,000 (135,000)	1,600,000 (180,000)	9.9-30.3 (44-135)	0.06	1.51 (0.68)						

Impact velocity range: 0.06 to 1.5 ft/sec (0.02 to 0.46 m/sec)

Note: Side load not to exceed 5°. Maximum side load depends on application.



Magnum Series MC/MA/ML 45
Self-Compensating and Adjustable

Primary Mount



Adjuster (MA and ML only)

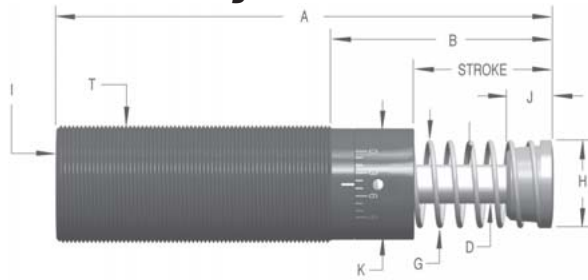

Clevis Mount

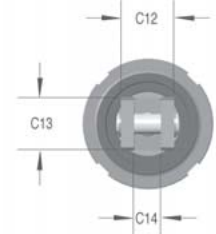
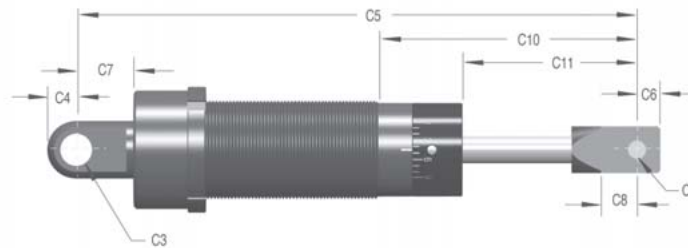
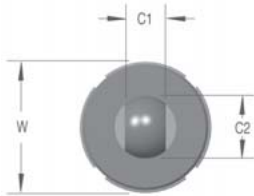

Side-Foot Mount

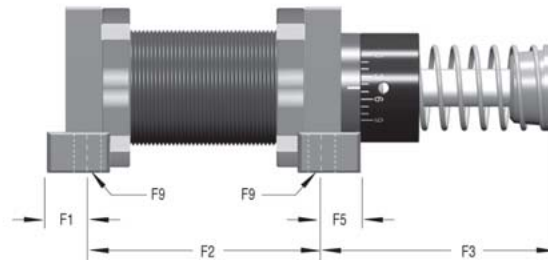
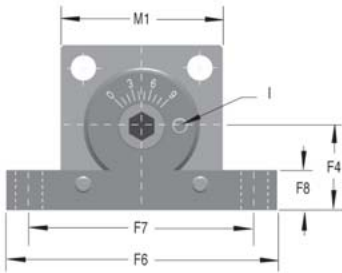

45 Model Dimensions IN INCHES (MILLIMETERS)															
Model	Stroke	A	B	D	G	H	I*	J	K	T	W	C1	C2	C3	C4
MC, MA, ML 4525	0.91 (23.1)	5.69 (144.5)	1.97 (50)												
MC, MA, ML 4550	1.91 (48.5)	7.69 (195.3)	2.97 (75.4)	0.50 (12.7)	1.36 (34.5)	1.38 (34.9)	1/8 NPT	0.87 (22.1)	1.65 (41.9)	1-3/4-12 M45x1.5	2.25 (57.20)	0.75 (19.1)	1.00 (25.4)	.5005 (12.7)	0.50 (12.7)
MC, MA 4575	2.91 (73.9)	9.69 (246.1)	3.97 (100.8)												
Model	C5	C6	C7	C8	C9	C10	C11	C12	C13	C14	F1	F2	F3	F4	F5
MC, MA, ML 4525	7.85 (199.4)					2.57 (65.3)	1.51 (38.4)					3.50 (88.9)	1.94 (49.3)		
MC, MA, ML 4550	9.85 (250.2)	0.50 (12.7)	1.06 (26.9)	0.69 (17.5)	.3755 (9.6)	3.57 (90.7)	2.51 (63.8)	1.00 (25.4)	1.00 (25.4)	.505 (12.8)	0.50 (12.7)	4.38 (111.8)	3.06 (77.7)	1.16 (29.5)	0.37 (9.5)
MC, MA, ML 4575	11.85 (301)					4.57 (116.1)	3.51 (89.2)					5.38 (237.8)	4.06 (103.1)		
Model	F6	F7	F8	F9											
MC, MA, ML 4525															
MC, MA, ML 4550	3.75 (95.3)	3.00 (76.2)	0.56 (14.2)	0.35 (8.9)											
MC, MA 4575															

*For models MAA and MAS 33 the 1/8-27 male fitting is shipped with the shock. MAA and MAS 45 and 64 have pipe plugs.

Magnum Series MC/MA/ML 45
Self-Compensating and Adjustable

Specifications...MC Series, Self-Compensating									
Model	We Effective Weight lbs (kg)		E3 Energy per Cycle in lbs (Nm)	Energy per Hour in lbs/hour (Nm/hour)			Return Force lbs (N)	Return Time sec	Shipping Weight lbs (kg)
				E4					
				Internal Accumulator (Self-Contained)	External Accumulator (A/O Tank)	External Accumulator (Re-circulating)			
MC 4525-1	50-200	(23-91)	3,000 (339)	950,000 (107,000)	1,400,000 (158,000)	1,700,000 (192,000)	15.1-22.8 (67-101)	0.03	2.5 (1.13)
MC 4525-2	170-680	(77-300)							
MC 4525-3	575-2,300	(261-1,043)							
MC 4525-4	1,950-7,800	(885-3,538)							
MC 4550-1	100-400	(45-181)	6,000 (678)	1,000,000 (112,000)	1,700,000 (192,000)	2,200,000 (248,000)	15.1-32.2 (67-143)	0.08	3.0 (1.36)
MC 4550-2	340-1,360	(154-617)							
MC 4550-3	1,150-4,600	(522-2,087)							
MC 4550-4	3,900-15,600	(1,769-7,076)							
MC 4575-1	150-600	(136-544)	9,000 (1,017)	1,300,000 (146,000)	2,000,000 (225,000)	2,500,000 (282,000)	11.7-40.3 (52-179)	0.11	3.5 (1.59)
MC 4575-2	510-2,040	(231-925)							
MC 4575-3	1,730-6,920	(785-3,139)							
MC 4575-4	5,850-23,400	(2,654-10,614)							

Impact velocity range: 0.5 to 16.5 ft/sec (0.15 to 5 m/sec)

Specifications...MA Series, Adjustable									
Model	We Effective Weight lbs (kg)	E3 Energy per Cycle in lbs (Nm)	E4 Internal Accumulator (Self-Contained)	E4 External Accumulator (A/O Tank)	E4 External Accumulator (Re-circulating)	Return Force lbs (N)	Return Time sec	Shipping Weight lbs (kg)	
MA 4525	95-22,000	(43-9,979)	3,450 (390)	950,000 (107,000)	1,400,000 (158,000)	1,700,000 (192,000)	15.1-22.8 (67-101)	0.03	2.5 (1.13)
MA 4550	150-32,000	(68-14,515)	6,900 (780)	1,000,000 (112,000)	1,700,000 (192,000)	2,200,000 (248,000)	15.1-32.2 (67-143)	0.08	3.0 (1.36)
MA 4575	155-33,000	(70-14,968)	10,350 (1,169)	1,300,000 (146,000)	2,000,000 (225,000)	2,500,000 (282,000)	11.7-40.3 (52-179)	0.11	3.5 (1.59)

Impact velocity range: 0.5 to 16.5 ft/sec (0.15 to 5 m/sec)

Specifications...ML Series, Low Velocity Adjustable									
Model	We Effective Weight lbs (kg)	E3 Energy per Cycle in lbs (Nm)	E4 Internal Accumulator (Self-Contained)	E4 External Accumulator (A/O Tank)	E4 External Accumulator (Re-circulating)	Return Force lbs (N)	Return Time sec	Shipping Weight lbs (kg)	
ML 4525	N/A	N/A	3,450 (390)	950,000 (107,000)	1,400,000 (158,000)	1,700,000 (192,000)	15.1-22.8 (67-98)	0.03	2.5 (1.13)
ML 4550	N/A	N/A	6,900 (780)	1,000,000 (112,000)	1,700,000 (192,000)	2,200,000 (248,000)	15.1-32.2 (67-143)	0.08	3.0 (1.36)

Impact velocity range: 0.06 to 1.5 ft/sec (0.02 to 0.46 m/sec)

Note: A side port can be adapted to Magnum Series 45 MAA, MLA and MCA models and is a special adder item. A side port adapter ring is molded onto the outer tube and increases the overall diameter by 0.5 inches (12.7 mm) in the area of the ring. The side port centerline is located 1.04 inches (26.4 mm) from the front of the outer tube. Add (-P) to the model ordering code if a side port is desired, see [page 34](#).

Note: Side load not to exceed 5°. Maximum side load depends on application.

Lock nut included with each shock absorber. See [page 51](#) for dimensions.

Magnum Series MC/MA/ML 64
 Self-Compensating and Adjustable

Primary Mount



Adjuster (MA and ML only)

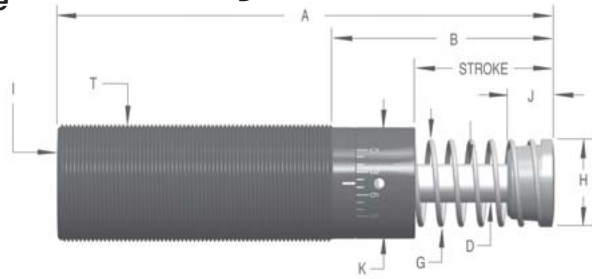

Clevis Mount

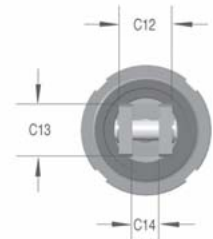
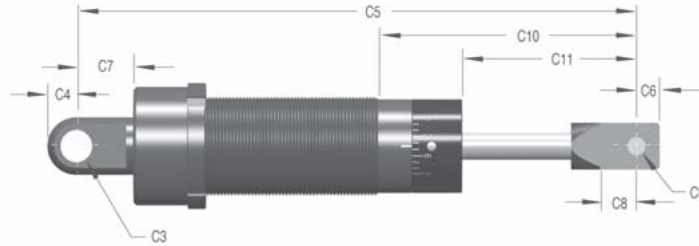
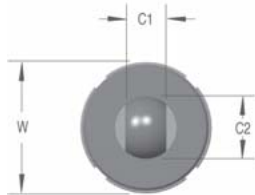

Side-Foot Mount

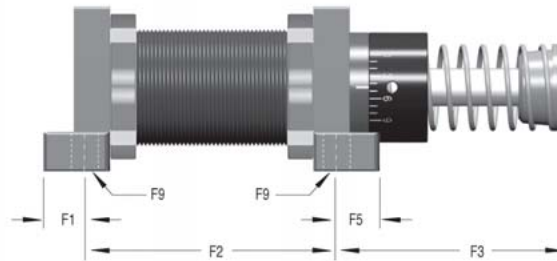
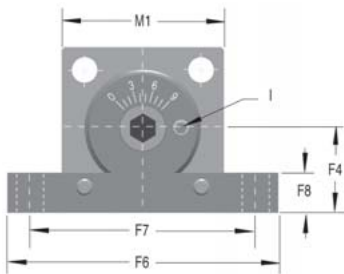

64 Model Dimensions IN INCHES (MILLIMETERS)															
Model	Stroke	A	B	D	G	H	I*	J	K	T	W	C1	C2	C3	C4
ML 6425	0.91 (23.1)	6.85 (174)	2.35 (59.7)												
MC, MA, ML 6450	1.91 (48.6)	8.85 (224.8)	3.35 (85.1)												
MC, MA 64100	3.91 (99.4)	12.85 (326.4)	5.35 (135.9)	0.75 (19.1)	1.86 (47.2)	1.90 (48.3)	1/4 NPT	1.06 (26.9)	2.37 (60.2)	2-1/2-12 M64x2	3.00 (76.20)	1.25 (31.8)	1.50 (38.1)	.7505 (19.1)	0.75 (19.1)
MC, MA 64150	5.91 (150.1)	17.73 (450.4)	8.23 (209)		2.31 (58.7)	2.38 (60.3)		1.25 (31.8)							
MCA, MAA 64150	5.91 (150.1)	17.60 (447)	8.10 (205.7)		N/A	1.90 (48.3)		1.06 (26.9)			N/A	N/A	N/A	N/A	N/A
Model	C5	C6	C7	C8	C9	C10	C11	C12	C13	C14	F1	F2	F3	F4	F5
ML 6425	10.12 (257.1)					3.75 (95.2)	2.31 (58.7)					4.00 (101.6)	2.56 (65.0)		
MC, MA, ML 6450	12.12 (307.9)					4.75 (120.7)	3.31 (84.1)					5.00 (127.00)	3.56 (90.4)		
MC, MA 64100	16.12 (409.5)	0.63 (16.0)	1.29 (32.8)	1.40 (35.6)	.7505 (19.1)	6.75 (171.5)	5.31 (134.9)	1.50 (38.1)	1.25 (31.8)	.625 (15.9)	0.69 (17.5)	7.00 (177.8)	5.56 (141.2)	1.78 (45.2)	0.69 (17.5)
MC, MA 64150	20.87 (530.1)					9.50 (241.3)	8.06 (204.7)					9.00 (228.6)	8.44 (214.4)		
MCA, MAA 64150	N/A	N/A	N/A	N/A	N/A	N/A	N/A	N/A	N/A	N/A			8.31 (211.1)		
Model	F6	F7	F8	F9											
ML 6425															
MC, MA, ML 6450															
MC, MA 64100	5.62 (142.8)	4.88 (124.0)	0.75 (19.1)	0.42 (10.7)											
MC, MA 64150															
MCA, MAA 64150															

Magnum Series MC/MA/ML 64
Self-Compensating and Adjustable

Specifications...MC Series, Self-Compensating									
Model	We Effective Weight lbs (kg)		E3 Energy per Cycle in lbs (Nm)	Energy per Hour in lbs/hour (Nm/hour)			Return Force lbs (N)	Return Time sec	Shipping Weight lbs (kg)
				E4					
				Internal Accumulator (Self-Contained)	External Accumulator (A/O Tank)	External Accumulator (Re-circulating)			
MC 6450-1	300-1,200	(136-544)	15,000 (1,695)	1,300,000 (146,000)	2,600,000 (293,000)	3,400,000 (384,000)	20.1-34.9 (89-155)	0.12	6.4 (2.90)
MC 6450-2	1,020-4,080	(463-1,851)							
MC 6450-3	3,460-13,840	(1,569-6,278)							
MC 6450-4	11,700-46,800	(5,307-21,228)							
MC 64100-1	600-2,400	(272-1,089)	30,000 (3,390)	1,700,000 (192,000)	3,400,000 (384,000)	4,400,000 (497,000)	23.5-61 (104-271)	0.34	8.15 (3.70)
MC 64100-2	2,040-8,160	(925-3,701)							
MC 64100-3	6,920-27,680	(3,139-12,556)							
MC 64100-4	23,400-93,600	(10,614-42,457)							
MC 64150-1	900-3,600	(408-1,633)	45,000 (5,084)	2,200,000 (248,000)	4,400,000 (497,000)	5,700,000 (644,000)	16.9-82.2 (75-366)	0.48	11.25 (5.10)
MC 64150-2	3,060-12,240	(1,388-5,552)							
MC 64150-3	10,380-41,520	(4,708-18,833)							
MC 64150-4	35,100-140,400	(15,921-63,685)							

Impact velocity range: 0.5 to 16.5 ft/sec (0.15 to 5 m/sec).

Specifications...MA Series, Adjustable									
Model	We Effective Weight lbs (kg)		E3 Energy per Cycle in lbs (Nm)	Internal Accumulator (Self-Contained)	External Accumulator (A/O Tank)	External Accumulator (Re-circulating)	Return Force lbs (N)	Return Time sec	Shipping Weight lbs (kg)
MA 6450	480-110,000	(218-49,895)	18,000 (2,034)	1,300,000 (146,000)	2,600,000 (293,000)	3,400,000 (384,000)	20.1-34.9 (69-155)	0.12	6.4 (2.90)
MA 64100	600-115,000	(272-52,163)	36,000 (4,067)	1,700,000 (192,000)	3,400,000 (384,000)	4,400,000 (497,000)	23.5-61 (104-271)	0.34	8.15 (3.70)
MA 64150	730-175,000	(331-79,379)	54,000 (6,101)	2,200,000 (248,000)	4,400,000 (497,000)	5,700,000 (644,000)	16.9-82.2 (75-366)	0.48	11.25 (5.10)

Impact velocity range: 0.5 to 16.5 ft/sec (0.15 to 5 m/sec).

Specifications...ML Series, Low Velocity Adjustable									
Model	We Effective Weight lbs (kg)		E3 Energy per Cycle in lbs (Nm)	Internal Accumulator (Self-Contained)	External Accumulator (A/O Tank)	External Accumulator (Re-circulating)	Return Force lbs (N)	Return Time sec	Shipping Weight lbs (kg)
ML 6425	N/A	N/A	9,000 (1,017)	1,100,000 (124,000)	2,200,000 (248,000)	2,900,000 (328,000)	26.7-34.9 (119-155)	0.06	5.5 (2.49)
ML 6450	N/A	N/A	18,000 (2,034)	1,300,000 (146,000)	2,600,000 (293,000)	3,400,000 (384,000)	20.1-34.9 (89-155)	0.12	6.4 (2.90)

Impact velocity range: 0.06 to 1.5 ft/sec (0.02 to 0.46 m/sec).

*For models MAA and MAS 33 the 1/8-27 male fitting is shipped with the shock. MAA and MAS 45 and 64 have pipe plugs.

Note: A side port can be adapted to Magnum Series 64 MAA, MLA and MCA models and is a special adder item. A side port adapter ring is molded onto the outer tube and increases the overall diameter by 0.5 inches (12.7 mm) in the area of the ring. The side port centerline is located 1.47 inches (37.3 mm) from the front of the outer tube. Add (-P) to the model ordering code if a side port is desired, see [page 34](#).

Note: MA and MC 64150 models include an integral, non-removable stop block, not a stop collar. Adjustable models can be adjusted from front or rear.

Note: MAA and MCA 64150 models include a stop collar, 0.75 inches (19 mm) longer than the standard 64 model stop collar.

Note: For models MAA, MLA and MCA indicate P for the side port option when ordering clevis mount.

Note: 64150 models do not include a stop collar. Adjustable models can still be adjusted from front or rear.

Note: Side load not to exceed 5°. Maximum side load depends on application.

Lock nut included with each shock absorber. See [page 51](#) for dimensions.

Ordering Information

MC Series, Self-Compensating

MC 3325 - 1 C

Return Method and Accumulator Style

MC = Self-Contained Spring Return, Internal Accumulator
 MCA = Air Return, External Accumulator
 MCS = Spring Return, External Accumulator
 MCN = Self Return (Clevis), Internal Accumulator

Mounting Thread

- Standard
 M Metric

Mounting Options

Standard Mount
 Flanged Stop Collar
 Rectangular Flange*
 Square Flange*
 -C Clevis Mount**
 -S Side-Foot Mount**
 -P Side Port
 -Z Within Air Cylinder

Model Number

3325	4525	6450
3350	4550	64100
3625	4575	64150
3650		

Effective Weight

-1 Light Range
 -2 Medium Range
 -3 Heavy Range
 -4 Heavier Range

* Welded versions available upon request.
 **Not available on MC 3625 and 3650 models.

MA Series, Adjustable

MA 3325 - C

Return Method and Accumulator Style

MA = Self-Contained Spring Return, Internal Accumulator
 MAA = Air Return, External Accumulator
 MAS = Spring Return, External Accumulator
 MAN = Self Return (Clevis), Internal Accumulator

Mounting Thread

- Standard
 M Metric

Mounting Options

Standard Mount
 Flanged Stop Collar
 Rectangular Flange*
 Square Flange*
 -C Clevis Mount**
 -S Side-Foot Mount**
 -P Side Port
 -Z Within Air Cylinder

Model Number

3325	4525	6450
3350	4550	64100
3625	4575	64150
3650		

* Welded versions available upon request.
 **Not available on MA 3625 and 3650 models.

ML Series, Low Velocity Adjustable

ML 3325 - C

Return Method and Accumulator Style

ML = Self-Contained Spring Return, Internal Accumulator
 MLA = Air Return, External Accumulator
 MLS = Spring Return, External Accumulator
 MLN = Self Return (Clevis), Internal Accumulator

Mounting Thread

- Standard
 M Metric

Mounting Options

Standard Mount
 Flanged Stop Collar
 Rectangular Flange*
 Square Flange*
 -C Clevis Mount**
 -S Side-Foot Mount**
 -P Side Port
 -Z Within Air Cylinder

Model Number

3325	4525	6425
3350	4550	6450
3625		
3650		

* Welded versions available upon request.
 **Not available on ML 3625 and 3650 models.

Note: Poly pad available on 33 models only...part no. 250-0011.

Note: Flanges and flanged stop collars are packaged separately from shock absorbers.



NOTES

1-1/2" Bore Series
Adjustable



1-1/2" bore series shock absorbers are designed for the toughest environments. These durable adjustable models provide outstanding deceleration over a wide range of effective weight conditions. Large energy capacities stop heavy loads set into motion by high propelling forces, without damage.

Applications include: Automotive manufacturing and production equipment, large robotics, heavy conveyors, foundries and steel industry equipment.

Technical Data

Impact velocity range: 0.5 to 15 ft/sec (0.15 to 4.5 m/sec)

Operating temperature: 10° to 150° F (-12° to 66° C)

Mechanical stop: Must be provided .09 inch (2.3 mm) before end of stroke.

Oil type: American 46

Materials: Steel body with black oxide finish. Piston rod high tensile steel, hardened and chrome plated. Return spring zinc plated.

Adjustment: After installation of the shock absorber, cycle the machine a number of times. Turn the adjustment ring against the scale marked 0 to 9, until optimum deceleration is achieved (i.e. smooth deceleration throughout the stroke).

Hard impact at the start of stroke-turn adjuster toward 9.

Hard set-down at the end of stroke-turn adjuster toward 0.

Poly pad: Optional

Specifications							
Model	We Effective Weight lbs (kg)	E3 Energy per Cycle in lbs (Nm)	Energy per Hour in lbs/hour (Nm/hour)		Return Force lbs (N)	Return Time sec	Shipping Weight lbs (kg)
			E4				
			Internal Accumulator (Self-Contained)	External Accumulator (A/O Tank)			
1-1/2 x 2	430-70,000 (195 - 31,750)	16,000 (1,800)	3,200,000 (361,550)	4,000,000 (451,900)	34.9 - 47.6 (155 - 210)	.10	16.4 (7.44)
1-1/2 x 3-1/2	480 - 80,000 (218 - 36,280)	28,000 (3,160)	5,600,000 (632,700)	7,000,000 (790,890)	25.4 - 47.6 (113-210)	.25	19.4 (8.80)
1-1/2 x 5	500 - 90,000 (227 - 40,800)	40,000 (4,500)	8,000,000 (903,870)	10,000,000 (1,129,840)	20.7 - 52.5 (92 - 230)	.40	22.7 (10.30)
1-1/2 x 6-1/2	680-100,000 (308 - 45,350)	52,000 (5,870)	10,400,000 (1,175,000)	13,000,000 (1,468,800)	20.7 - 97.4 (92 - 430)	.40	25.0 (11.34)

Ordering Information

A 1-1/2 x 6-1/2 - F

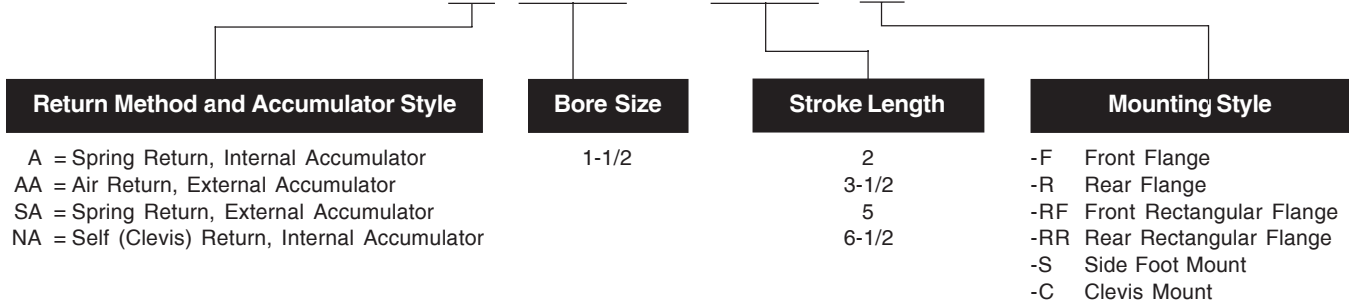

1-1/2" Bore Series
Adjustable

Rear Flange

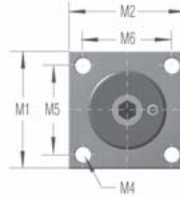
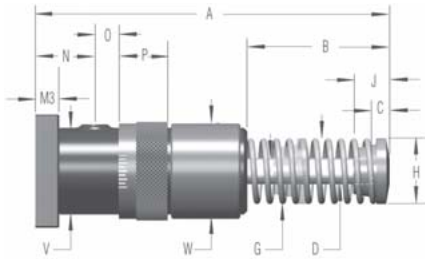

Front Flange



Side-Foot Mount

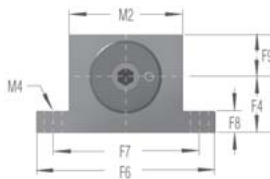

Poly Pad

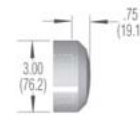

Part No. 250-0003

Clevis Mount

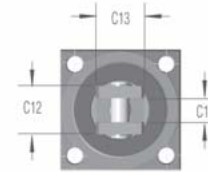
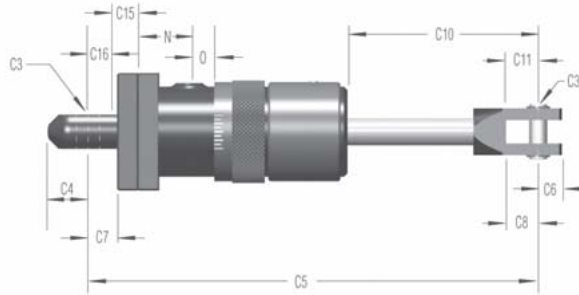
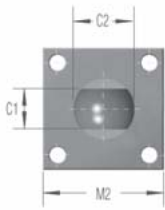

1-1/2" Bore Series Dimensions IN INCHES (MILLIMETERS)																							
Size	Stroke	A	B	C	D	G	H	I	J	N	O	P	V	W	C1	C2	C3	C4	C5	C6	C7		
1-1/2 x 2	2.00 (50.8)	9.69 (246.1)	4.13 (104.8)							1.38 (35.0)	0.28 (7.1)								12.94 (328.6)				
	1-1/2 x 3-1/2	3.50 (88.9)	12.69 (322.3)	5.63 (142.9)	0.81 (20.6)	1.00 (25.4)	2.69 (68.3)	2.75 (69.9)	1/2 NPT	1.38 (35.1)	2.00 (50.8)	0.28 (7.1)	1.25 (31.8)	3.00 (76.2)	4.00 (101.6)	1.25 (31.8)	1.50 (38.1)	0.7525 (19.11)	0.75 (19.1)	405.6 (16.0)	0.63 (16.0)	1.25 (31.8)	
1-1/2 x 5		5.00 (127.0)	15.69 (398.5)	7.13 (181.0)						2.00 (50.8)	1.03 (26.2)								18.97 (481.8)				
1-1/2 x 6-1/2	6.50 (165.1)	19.44 (493.7)	9.38 (238.1)						2.00 (50.8)	1.78 (45.2)								22.72 (577.1)					
Size	C8	C10	C11	C12	C13	C14	C15	C16	F1	F2	F3	F4	F5	F6	F7	F8	F9	M1	M2	M3	M4	M5	M6
1-1/2 x 2		5.41 (137.3)								**5.18 (131.6)	**4.31 (109.5)												
1-1/2 x 3-1/2	1.41 (35.7)	6.91 (175.4)	1.40 (35.6)	1.50 (38.1)	1.25 (31.8)	5/8	0.94 (23.9)	1.06 (27.0)	0.63 (15.9)	6.69 (169.9)	5.81 (147.6)	2.00 (50.8)	0.63 (16.0)	6.50 (165.1)	5.50 (139.7)	0.75 (19.1)	2.03 (51.6)	4.00 (101.6)	4.00 (101.6)	0.75 (19.0)	0.53 (13.5)	3.00 (76.2)	3.00 (76.2)
		8.41 (213.5)								8.19 (208.0)	7.31 (185.7)												
1-1/2 x 5										9.69 (246.1)	9.56 (242.8)												
1-1/2 x 6-1/2		10.66 (270.7)																5.00 (127.0)				4.00 (101.6)	

*Rectangular flange dimension

**Note: 1-1/2 x 2 shock absorbers available with side-foot mount in AA and SA models only.

Heavy Industrial Shock Absorbers CA 2 to CA 4
Self-Compensating

CA 2, CA 3 and 4" Bore Series of self-compensating shock absorbers are designed for extremely heavy duty applications and provide smooth deceleration under changing conditions. High energy capacities combined with wide effective weight ranges qualify these units to perform in the most demanding environments.

The new **CA 2 offers up to 170% of the energy per cycle capacity** of former models. The rugged new **CA 3 offers up to 125% of the energy capacity** of former models. You can select the correct model for your application by utilizing the PARKERSIZE INDUSTRIAL SHOCK ABSORBER SIZING PROGRAM or the capacity charts. Replacing existing shock absorbers with the new CA Series is easy-just provide us the type and adjustment setting of your existing units and we will, do the rest. These dependable units are available self-contained or for use with an external air/oil tank.

Applications include: foundry, steel, marine, lumber and other heavy equipment industries.

Technical Data

Impact velocity range: 1 to 16.5 ft/sec (0.30 to 5 m/sec)

Operating Temperature: 10° to 150°F (-12° to 66°C)

Mechanical stop:

2", 3" bore: Must be provided .09 inch (2.3 mm) before end of stroke.

4" bore: Must be provided .09 inch (2.3mm) before end of stroke.

Oil type: ATF

Materials: Steel body with black oxide finish. Piston rod high tensile steel, hardened and chrome plated. Return spring zinc plated.

Note: See [pages 44](#) and [45](#) for CA 4" Bore dimensions and specifications.

**Heavy Industrial Shock Absorbers A2 and A3
Adjustable**

A2 and A3 Series adjustable shock absorbers are capable of decelerating heavy duty loads. These reliable units replace the former 2" and 3" large bore adjustable shock absorbers.

Energy capacity ratings are 228% of former models. In addition, effective weight ranges have increased dramatically, resulting in the capability of handling a wider range of applications and increases in velocity. The units are easily adjusted by means of a 5/16 inch (8 mm) hex socket adjuster located at the bottom of the outer body. These dependable shock absorbers are maintenance free and are available self-contained or for use with an external air/oil tank.

Features include a considerably reduced outer diameter, internal accumulator and threaded mounting brackets, easily adaptable to the front or rear of the outer body.

Applications include: foundry, steel, marine, lumber, and other heavy equipment industries.

**Technical Data**

Impact velocity range: 0.33 to 16.5 ft/sec (0.1 to 5 m/sec)

Operating temperature: 10° to 150° F (-12° to 66° C)

Mechanical stop: Must be provided .09 inch (2.3 mm) before end of stroke.

Oil type: ATF

Materials: Steel body with black oxide finish. Piston rod high tensile steel, hardened and chrome plated. Return spring zinc plated. To avoid reducing heat dissipation, do not paint.

Adjustment: After installation of the shock absorber, cycle the machine a number of times. Turn the hex socket adjuster against the scale marked 0 to 9, until optimum deceleration is achieved (i.e. smooth deceleration throughout the stroke).

Hard impact at the start of stroke-turn adjuster toward 9.

Hard set-down at the end of stroke-turn adjuster toward 0.

CA and A 2", 3" Bore Series – Heavy Duty Models
 (CA) Self-Compensating and (A) Adjustable

Rear Flange

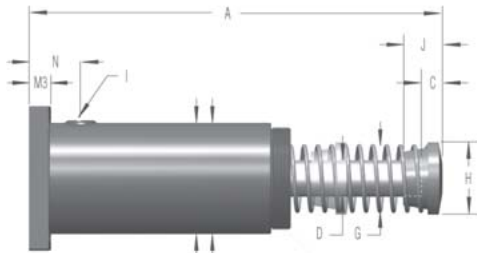

AA & SA adjustable models only
 4.25 (108.0 mm) – 2" bore
 5.50 (139.7 mm) – 3" bore

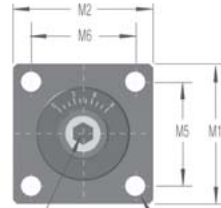

5/16" (8 mm) hex socket adjuster adjustable models only

Front Flange

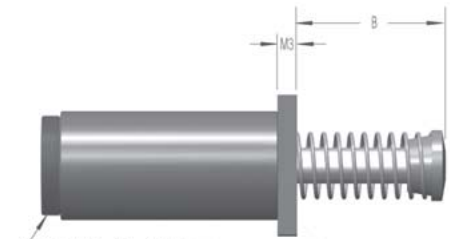

M100 x 2 – 2" bore
 M130 x 2 – 3" bore

2" Bore Foot Mount

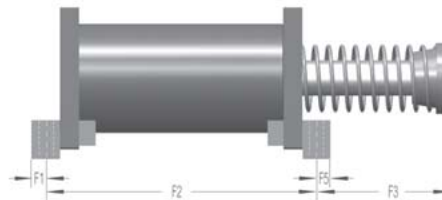
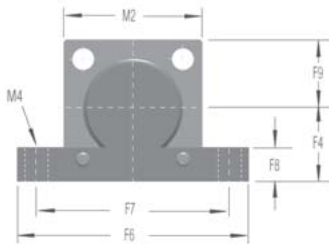

Rectangular Flange

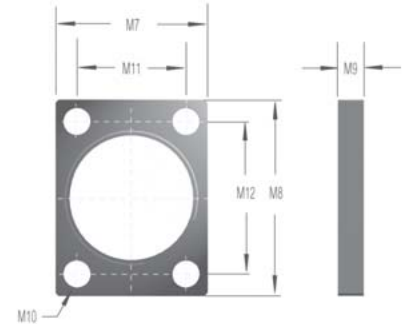

3" Bore Foot Mount

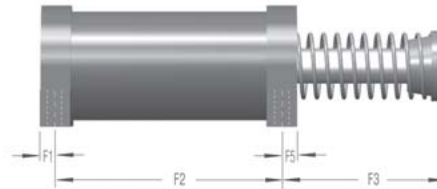
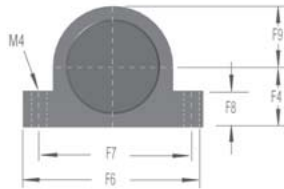

**(A) Adjustable
 2" & 3" Bore Models**

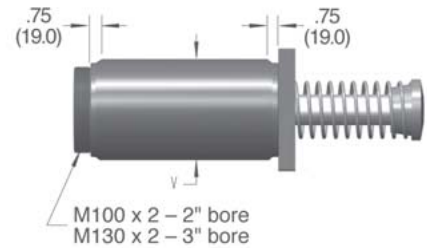

Clevis Mount

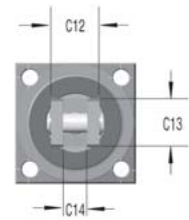
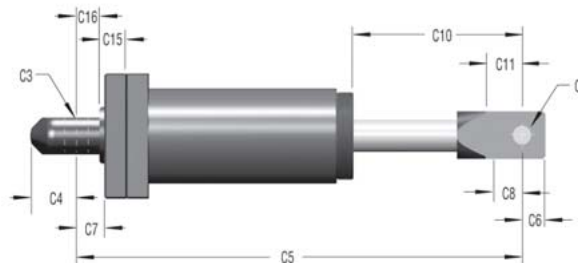
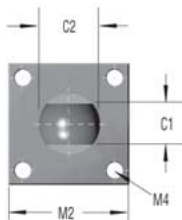

CA and A 2", 3" Bore Series – Heavy Duty Models
(CA) Self-Compensating and (A) Adjustable

Dimensions IN INCHES (MILLIMETERS) Self Compensating and Adjustable Models																						
Size	Stroke	A	B	C	D	G	H	I	J	N	V	C1	C2	C3	C4	C5	C6	C7	C8	C10	C11	
CA 2x2	2.00	12.31	4.31	0.82		3.06	2.75		1.38							17.00				6.05	2.06	
A 2x2	(50.8)	(312.7)	(109.5)	(20.8)		(77.7)	(69.9)		(35.1)							(431.8)				(153.7)	(52.3)	
CA 2x4	4.00	16.31	6.31	0.82		3.06	2.75		1.38		CA					21.00				8.05	2.06	
A 2x4	(101.6)	(414.0)	(160.3)	(20.8)		(77.7)	(69.9)		(35.1)		4.25					(533.4)				(204.4)	(52.3)	
CA 2x6	6.00	20.31	8.31	0.82	1.38	3.63	2.75	3/4	1.38	3.50	(108.0)	1.50	2.25	1.005	1.00	25.00	1.00	2.00	1.50	10.05	2.06	
A 2x6	(152.4)	(515.9)	(211.1)	(20.8)	(35.1)	(92.2)	(69.9)	NPT	(35.1)	(88.9)		(38.1)	(57.2)	(25.5)	(25.4)	(635)	(25.4)	(50.8)	(38.1)	(255.2)	(52.3)	
CA 2x8	8.00	25.31	11.31	1.82		4.00	3.63		2.38		A*					29.00				12.05	0.75	
A 2x8	(203.2)	(642.9)	(287.3)	(46.2)		(101.6)	(92.2)		(60.5)		4.63					(736.6)				(306.1)	(19)	
CA 2x10	10.00	29.31	13.31	1.82		4.50	4.25		2.38		(118.0)					33.00				14.05	1.06	
A 2x10	(254)	(744.5)	(338.1)	(46.2)		(114.3)	(108.0)		(60.5)							(838.2)				(356.9)	(26.9)	
CA 3x5	5.00	19.25	8.25			4.75					CA					23.00				9.05		
A 3x5	(127)	(489.0)	(209.6)			(120.7)					5.50					(584.2)				(229.9)		
CA 3x8	8.00	25.25	11.25	2.00	1.75	4.75	4.38	3/4	2.75	3.13	(139.7)	1.50	2.25	1.01	1.00	29.00	1.00	2.00	1.50	12.05	1.12	
A 3x8	(203.2)	(641.4)	(285.8)	(50.8)	(44.5)	(120.7)	(111.3)	NPT	(69.9)	(79.5)		(38.1)	(57.2)	(25.5)	(25.4)	(736.6)	(25.4)	(50.8)	(38.1)	(306.1)	(28.4)	
CA 3x12	12.00	35.03	17.03			4.84					A*					38.78				17.83		
A 3x12	(304.8)	(889.8)	(432.6)			(122.9)					(152.4)					(985)				(452.9)		
Size	Stroke	C12	C13	C14	C15	C16	F1	F2	F3	F4	F5	F6	F7	F8	F9	M1	M2	M3	M4	M5	M6	
CA 2x2	2.00								9.5	3.44												
A 2x2	(50.8)								(241.3)	(87.4)												
CA 2x4	4.00								11.5	5.44												
A 2x4	(101.6)								(292.1)	(138.2)												
CA 2x6	6.00	3.5	2.00	1.50	1.25	1.75	0.63		13.5	7.44	3.13	0.63	8.00	6.50	1.50	2.75	5.50	5.50	0.75	0.66	4.38	4.38
A 2x6	(152.4)	(88.9)	(50.8)	(38.1)	(31.8)	(44.5)	(16.0)		(342.9)	(189.0)	(79.5)	(16.0)	(203.2)	(165.1)	(38.1)	(69.9)	(139.7)	(139.7)	(19.1)	(16.8)	(111.3)	(111.3)
CA 2x8	8.00								15.5	10.44												
A 2x8	(203.2)								(393.7)	(265.2)												
CA 2x10	10.00								17.5	12.44												
A 2x10	(254)								(444.5)	(316.0)												
CA 3x5	5.00								10.25	8.50												
A 3x5	(127)								(260.4)	(215.9)												
CA 3x8	8.00	3.5	2.00	1.50	1.25	1.75	1.00		13.25	11.50	3.15	1.00	10.00	8.50	1.73	3.15	6.00	6.50	1.00	0.66	4.88	5.38
A 3x8	(203.2)	(88.9)	(50.8)	(38.1)	(31.8)	(44.5)	(25.4)		(336.6)	(292.1)	(80.0)	(25.4)	(254.0)	(215.9)	(43.9)	(80.0)	(152.4)	(165.1)	(25.4)	(16.8)	(124.0)	(136.7)
CA 3x12	12.00								17.25	17.28												
A 3x12	(304.8)								(438.2)	(438.9)												
Size		M7	M8	M9	M10	M11	M12	*See rear flange illustration on page 44 for AA and SA model dimensions.														
CA 3	Rectangular Flange	6.50	8.00	1.00	0.78	4.50	6.50															
A 3		(165.1)	(203.2)	(25.4)	(19.8)	(114.3)	(165.1)															

Specifications...Self-Compensating Models

Model	We Effective Weight lbs (kg)	E3 Energy per Cycle in lbs (Nm)	Energy per Hour in lbs/hour (Nm/hour) E4			Return Force lbs (N)	Return Time sec	Shipping Weight lbs (kg)	
			Internal Accumulator (Self-Contained)	Extenal Accumulator (A/O Tank)	A/O Tank (Re-circulating)				
CA 2 x 2-1	1,600-4,800	(726-2,177)	32,000 (3,616)	9,600,000 (1,084,650)	12,000,000 (1,355,820)	15,600,000 (1,762,564)	48-63 (214-280)	0.25	28.2 (12.79)
CA 2 x 2-2	4,000-12,000	(1,814-5,443)							
CA 2 x 2-3	10,000-30,000	(4,536-13,608)							
CA 2 x 2-4	25,000-75,000	(11,340-34,019)							
CA 2 x 4-1	3,200-9,600	(1,452-4,354)	64,000 (7,231)	12,000,000 (1,355,820)	15,000,000 (1,694,770)	19,500,000 (2,203,200)	34-63 (151-280)	0.50	32.6 (14.79)
CA 2 x 4-2	8,000-24,000	(3,629-10,886)							
CA 2 x 4-3	20,000-60,000	(9,072-27,216)							
CA 2 x 4-4	50,000-150,000	(22,680-68,039)							
CA 2 x 6-1	4,800-14,400	(2,117-6,532)	96,000 (10,847)	14,400,000 (1,626,980)	18,000,000 (2,033,730)	23,500,000 (2,655,140)	34-90 (151-400)	0.60	37.2 (16.87)
CA 2 x 6-2	12,000-36,000	(5,443-16,329)							
CA 2 x 6-3	30,000-90,000	(13,608-40,823)							
CA 2 x 6-4	75,000-225,000	(34,019-102,058)							

Note: All dimensions and tolerance values listed in this catalog are nominal and subject to change without prior notice.



CA and A 2", 3" Bore Series – Heavy Duty Models
(CA) Self-Compensating and (A) Adjustable

Specifications (continued)...Self-Compensating Models									
Model	We Effective Weight lbs (kg)		E3 Energy per Cycle in lbs (Nm)	Energy per Hour in lbs/hour (Nm/hour)			Return Force lbs (N)	Return Time sec	Shipping Weight lbs (kg)
				E4					
				Internal Accumulator (Self-Contained)	External Accumulator (A/O Tank)	A/O Tank (Re-circulating)			
CA 2 x 8-1	6,400-19,200	(2,903-8,709)	128,000 (14,462)	16,800,000 (1,898,150)	21,000,000 (2,372,680)	27,000,000 (3,050,590)	51-144 (227-641)	0.70	42.6 (19.32)
CA 2 x 8-2	16,000-48,000	(7,257-21,772)							
CA 2 x 8-3	40,000-120,000	(18,144-54,431)							
CA 2 x 8-4	100,000-300,000	(45,359-136,708)							
CA 2 x 10-1	8,000-24,000	(3,629-10,886)	160,000 (18,078)	19,200,000 (2,169,310)	24,000,000 (2,711,640)	31,000,000 (3,502,530)	35-101 (156-449)	0.80	50.2 (22.77)
CA 2 x 10-2	20,000-60,000	(9,072-27,216)							
CA 2 x 10-3	50,000-150,000	(22,680-68,039)							
CA 2 x 10-4	125,000-375,000	(56,700-170,097)							
CA 3 x 5-1	6,400-19,200	(2,903-8,709)	125,000 (14,123)	20,000,000 (2,259,700)	25,000,000 (2,824,620)	32,500,000 (3,672,010)	59-156 (262-694)	0.60	63.8 (28.94)
CA 3 x 5-2	16,000-48,000	(7,257-21,772)							
CA 3 x 5-3	40,000-120,000	(18,144-54,431)							
CA 3 x 5-4	100,000-300,000	(45,359-136,078)							
CA 3 x 8-1	10,240-30,720	(4,645-13,934)	200,000 (22,597)	32,000,000 (3,615,520)	40,000,000 (4,519,390)	52,000,000 (5,875,210)	62-162 (275-721)	0.80	73.6 (33.38)
CA 3 x 8-2	25,600-76,800	(11,612-34,836)							
CA 3 x 8-3	64,000-192,000	(29,030-87,090)							
CA 3 x 8-4	160,000-480,000	(72,575-217,724)							
CA 3 x 12-1	15,360-46,080	(6,967-20,902)	300,000 (33,896)	48,000,000 (5,423,270)	60,000,000 (6,779,090)	78,000,000 (8,812,820)	60-160 (267-712)	1.20	89.4 (40.55)
CA 3 x 12-2	38,400-115,200	(17,418-52,254)							
CA 3 x 12-3	96,000-288,000	(43,545-130,635)							
CA 3 x 12-4	240,000-720,000	(108,862-326,587)							

Specifications...Adjustable Models									
Model	We Effective Weight lbs (kg)		E3 Energy per Cycle in lbs (Nm)	Energy per Hour in lbs/hour (Nm/hour)			Return Force lbs (N)	Return Time sec	Shipping Weight lbs (kg)
				E4					
				Internal Accumulator (Self-Contained)	External Accumulator (A/O Tank)	A/O Tank (Re-circulating)			
A 2 x 2	560-170,000	(254-77,111)	32,000 (3,616)	9,600,000 (1,084,650)	12,000,000 (1,355,820)	15,600,000 (1,762,564)	48-63 (214-280)	0.25	31.5 (14.29)
A 2 x 4	510-160,000	(231-72,576)	80,000 (9,039)	12,000,000 (1,355,820)	15,000,000 (1,694,770)	19,500,000 (2,203,200)	34-63 (151-280)	0.50	36.9 (16.74)
A 2 x 6	570-190,000	(259-86,183)	120,000 (13,558)	14,400,000 (1,626,980)	18,000,000 (2,033,730)	23,500,000 (2,655,140)	34-90 (151-400)	0.60	42.6 (19.32)
A 2 x 8	580-200,000	(263-90,719)	170,000 (19,207)	16,800,000 (1,898,150)	21,000,000 (2,372,680)	27,000,000 (3,050,590)	51-144 (227-641)	0.70	49.1 (22.27)
A 2 x 10	720-250,000	(3279-113,399)	210,000 (23,727)	19,200,000 (2,169,310)	24,000,000 (2,711,640)	31,000,000 (3,502,530)	35-101 (156-449)	0.80	57.8 (26.22)
A 3 x 5	1,050-340,000	(476-154,223)	140,000 (15,818)	20,000,000 (2,259,700)	25,000,000 (2,824,620)	32,500,000 (3,672,010)	59-156 (262-694)	0.60	72.1 (32.70)
A 3 x 8	1,200-400,000	(544-181,439)	250,000 (28,246)	32,000,000 (3,615,520)	40,000,000 (4,519,390)	52,000,000 (5,875,210)	62-162 (275-721)	0.80	84.9 (38.51)
A 3 x 12	1,350-450,000	(612-204,119)	390,000 (44,064)	48,000,000 (5,423,270)	60,000,000 (6,779,090)	78,000,000 (8,812,820)	60-160 (267-712)	1.20	105.0 (47.63)

CA and A 2", 3" Bore Series – Heavy Duty Models
(CA) Self-Compensating and (A) Adjustable

Ordering Information – Self Compensating Models

CA 2 x 8 R - 3

Return Method and Accumulator Style	Bore Size	Stroke Length		Mounting Style	Effective Weight
CA = Spring Return, Internal Accumulator	2	2	8	-F Front Flange	-1 Light
CAA = Air Return, External Accumulator	3	4	10	-R Rear Flange	-2 Medium Light
CSA = Spring Return, External Accumulator		5	12	-RF Rectangular Front Flange	-3 Medium Heavy
CNA = Self (Clevis) Return, Internal Accumulator		6		-RR Rectangular Rear Flange	-4 Heavy
				-S Side Foot Mount	
				-C Clevis Mount	

Ordering Information – Adjustable Models

A 2 x 8 - R

Return Method and Accumulator Style	Bore Size	Stroke Length		Mounting Style
A = Spring Return, Internal Accumulator	2	2	8	-F Front Flange
AA = Air Return, External Accumulator	3	4	10	-R Rear Flange
SA = Spring Return, External Accumulator		5	12	-RF Rectangular Front Flange
NA = Self (Clevis) Return, Internal Accumulator		6		-RR Rectangular Rear Flange
				-S Side Foot Mount
				-C Clevis Mount

Note: A no button option is available on the 3" Bore only as a special.

**CA 4" Bore Series – Heavy Duty Models
 Self-Compensating**

Rear Flange

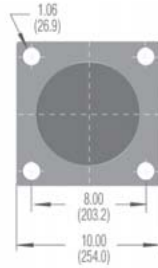
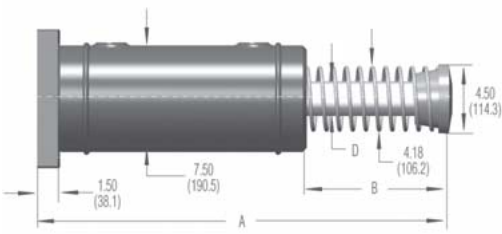

Front Flange

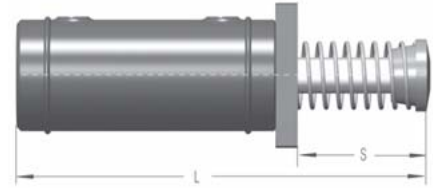

Standard Mount

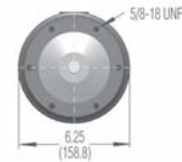
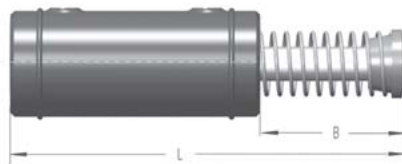

Side-Foot Mount

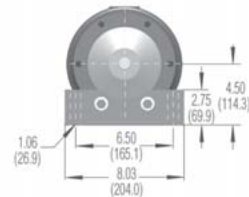

Clevis Mount

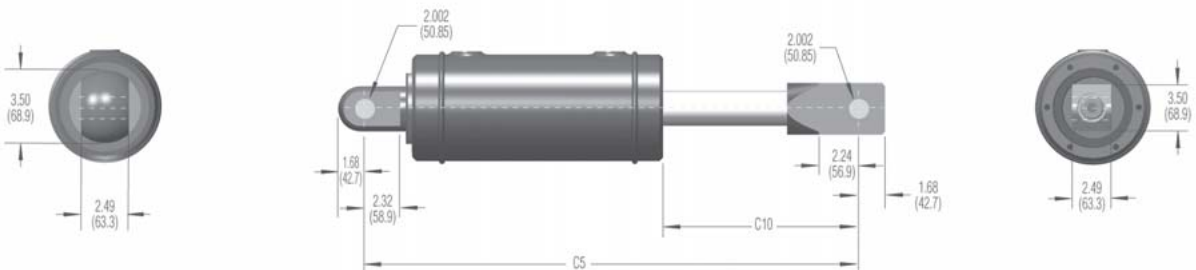

Technical Data

Impact velocity range: 1 to 16.5 ft/sec (0.30 to 5 m/sec)

Operating Temperature: 10° to 150°F (-12° to 66°C)

Mechanical stop:

2", 3" bore: Must be provided .09 inch (2.3 mm) before end of stroke.

Oil type: ATF

CA 4" Bore Series – Heavy Duty Models
Self-Compensating

Dimensions IN INCHES (MILLIMETERS)											
Size	Stroke	A	B	D	H	L	S	C5	C10	F2	F3
CA 4 x 6	6.00 (152.4)	28.21 (716.5)	10.96 (278.4)	2.12 (53.8)	4.50 (114.3)	26.71 (678.4)	9.46 (240.3)	33.03 (839.0)	12.90 (327.7)	17.50 (447.5)	10.90 (256.3)
CSA 4 x 6		26.21 (665.7)	8.96 (227.6)			24.71 (678.4)	7.46 (188.0)	31.03 (788.2)	10.90 (276.9)		8.09 (205.5)
CAA 4 x 6		N/A	N/A			N/A	N/A	N/A	N/A		N/A
CNA 4 x 6		N/A	N/A			N/A	N/A	N/A	N/A		N/A
CA 4 x 8	8.00 (203.2)	32.31 (818.1)	12.96 (329.2)	2.12 (53.8)	4.50 (114.3)	30.71 (780.0)	11.46 (291.1)	37.03 (940.6)	14.90 (378.5)	19.50 (495.3)	12.09 (307.1)
CSA 4 x 8		30.21 (767.3)	10.96 (278.4)			28.71 (729.2)	9.46 (240.3)	35.03 (889.8)	12.90 (327.7)		10.09 (256.3)
CAA 4 x 8		N/A	N/A			N/A	N/A	N/A	N/A		N/A
CNA 4 x 8		N/A	N/A			N/A	N/A	N/A	N/A		N/A
CA 4 x 16	16.00 (406.4)	51.21 (1,300.7)	23.96 (608.6)	2.50 (63.5)	5.00 (127.0)	49.71 (1,262.6)	22.46 (570.5)	56.03 (1,423.2)	25.90 (657.9)	27.50 (698.5)	23.09 (586.5)
CSA 4 x 16		46.21 (1,173.7)	18.96 (481.6)			44.71 (1,135.6)	17.46 (443.5)	51.03 (1,296.2)	20.90 (530.9)		18.09 (459.5)
CAA 4 x 16		N/A	N/A			N/A	N/A	N/A	N/A		N/A
CNA 4 x 16		N/A	N/A			N/A	N/A	N/A	N/A		N/A

Specifications								
Model	We Effective Weight lbs (kg)		E3 Energy per Cycle in lbs (Nm)	Energy per Hour in lbs/hour (Nm/hour) E4		Return Force lbs (N)	Return Time sec	Shipping Weight lbs (kg)
				Internal Accumulator (Self-Contained)	External Accumulator (A/O Tank)			
4 x 6-3	8,000-19,000	(3,600-8,600)	420,000 (47,500)	27,000,000 (3,000,000)	45,000,000 (5,100,000)	108-222 (480-1,000)	Consult Factory	132 (60)
4 x 6-5	19,000-41,000	(8,600-18,600)						
4 x 6-7	41,000-94,000	(18,600-42,700)						
4 x 8-3	11,000-25,000	(5,000-11,400)	560,000 (63,300)	30,000,000 (3,400,000)	50,000,000 (5,600,000)	71-222 (310-1,000)	Consult Factory	150 (68)
4 x 8-5	25,000-55,000	(11,400-25,000)						
4 x 8-7	55,000-125,000	(25,000-57,000)						
4 x 16-3	22,000-50,000	(10,000-23,000)	1,120,000 (126,500)	50,000,000 (5,600,000)	85,000,000 (9,600,000)	Consult Factory	Consult Factory	321 (146)
4 x 16-5	50,000-110,000	(23,000-50,000)						
4 x 16-7	110,000-250,000	(50,000-114,000)						

Ordering Information

CA 4 x 8 R - 5

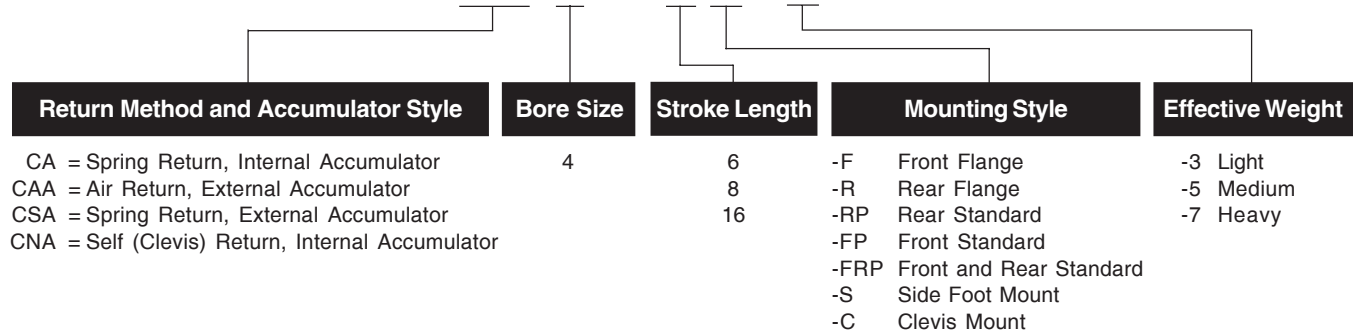

Miniature Shock Absorber Accessories
Mounting Blocks

Mounting Block

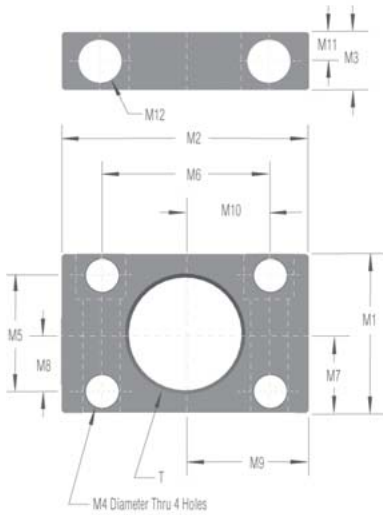

Lock Nut

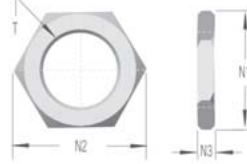

One lock nut included with each shock absorber where appropriate.

Stop Collar

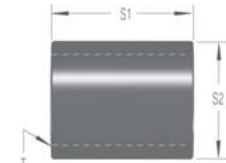

Side load adapters are available for select models, see pages 48 and 49.

Mounting Block		IN INCHES (MILLIMETERS)											Lock Nut			Stop Collar					
Used With	Part #	T	M1	M2	M3	M4	M5	M6	M7	M8	M9	M10	M11	M12	Part #	N1	N2	N3	Part #	S1	S2
MC 10E MC 10M	N/A	M8x0.75 M8x1													250-0362 250-0482	.43 (11)	.49 (12.5)	.12 (3.0)	N/A		
MC 25	250-0306	3/8-32 UNF	1.00 (25.4)	1.50 (38.1)	.56 (14.2)	See DIM M12	0 (0)	1.00 (25.4)	.50 (12.7)	0 (0)	.75 (19.1)	.50 (12.7)	.28 (7.1)	.18 Dia. Thru .31 C Bore x 20 Deep #8-32 Soc. Hd. Screw	250-0404	.50 (12.7)	.56 (14.2)	.09 (2.3)	250-0406	.81 (20.6)	.56 (14.2)
MC 25M	250-0307	M10x1				See DIM M12								(4.5) Dia. Thru (8) C Bore x (5) Deep M4x7 Soc. Hd. Screw	250-0315	.55 (14.0)	.59 (15.0)	.12 (3.0)	250-0408	.79 (20.0)	.56 (14.3)
MA 35 MC 75	250-0308	1/2-20 UNF	1.00 (25.4)	1.50 (38.1)	.56 (14.2)	See DIM M12	0 (0)	1.00 (25.4)	.50 (12.7)	0 (0)	.75 (19.1)	.50 (12.7)	.28 (7.1)	.18 Dia. Thru .31 C Bore x 20 Deep #8-32 Soc. Hd. Screw	250-0405	.62 (16.5)	.70 (17.8)	.13 (3.3)	250-0407	.81 (20.6)	.62 (15.7)
MA 35M MC 75M	250-0309	M12x1				See DIM M12								(4.5) Dia. Thru (8) C Bore x (5) Deep M4x7 Soc. Hd. Screw	250-0317	.55 (14.0)	.63 (16.0)	.16 (4.0)	250-0409	.79 (20.0)	.63 (16.0)
MA 150 MC 150 SC 190	250-0318	9/16-18 UNF	1.37 (34.8)	1.81 (46.0)	.62 (15.7)	.22 (5.6)	1.00 (25.4)	1.38 (35.1)	.69 (17.5)	.50 (12.7)	.91 (23.1)	.69 (17.5)	.31 (7.9)	.21 Dia. Thru .32 C Bore x 32 Deep #10-32 Soc. Hd. Screw	250-0231	.88 (22.4)	1.00 (25.4)	.31 (7.9)	250-0271	.75 (19.1)	.69 (17.5)
MA 150M MC 150M SC 190M	250-0352	M14x1.5	1.10 (28.0)	1.77 (45.0)	.63 (16.0)	.18 (4.5)	0 (0)	1.38 (35.0)	.55 (14.0)	0 (0)	.89 (22.5)	.69 (17.5)	.31 (7.9)	(4.5) Dia. Thru (8) C Bore x (5) Deep M4x7 Soc. Hd. Screw	250-0233	.67 (17.0)	.77 (19.6)	.20 (5.0)	250-0272	.79 (20.0)	.69 (17.5)
MC 225 MA 225 MVC 225 SC 300	250-0401	3/4-16 UNF	1.50 (38.1)	2.00 (50.8)	.62 (15.7)	.22 (5.6)	1.12 (28.4)	1.50 (38.1)	.75 (19.1)	.56 (14.2)	1.00 (25.4)	.75 (19.1)	.31 (7.9)	.22 Dia. Thru .33 C Bore x 45 Deep #10-32 Soc. Hd. Screw	250-0399	1.00 (25.4)	1.15 (29.2)	.25 (6.4)	250-0403	1.25 (38.1)	1.00 (25.4)
MC 225M MA 225M MVC 225M SC 300M	250-0353	M20x1.5	1.38 (35.0)	1.85 (47.0)	.63 (16.0)	.22 (5.6)	1.00 (25.4)	1.38 (35.0)	.69 (17.5)	.50 (12.7)	.93 (23.5)	.69 (17.5)	.31 (7.9)	(5.5) Dia. Thru (10) C Bore x (10) Deep M5x8 Soc. Hd. Screw	250-0207	.94 (24.0)	1.10 (28.0)	.24 (6.0)	250-0410	.98 (25.0)	.98 (25.0)
MC 600 MA 600 MVC 600 SC 650 MA 900 MVC 900 SC 925	250-0402	1-12 UNF	1.50 (38.1)	2.00 (50.8)	.62 (15.7)	.22 (5.6)	1.12 (28.4)	1.50 (38.1)	.75 (19.1)	.56 (14.2)	1.00 (25.4)	.75 (19.1)	.31 (7.9)	.22 Dia. Thru .33 C Bore x 45 Deep #10-32 Soc. Hd. Screw	250-0400	1.25 (31.8)	1.44 (36.6)	.25 (6.4)	250-0275	1.75 (44.5)	1.25 (31.8)
MC600ML	N/A														250-0239	1.25 (31.8)	1.44 (36.6)	.31 (7.9)	250-0263	1.77 (45.0)	1.26 (32.0)
MC 600M MA 600M MVC 600M SC 650M MA 900M MVC 900M SC 925M	250-0044	M25x1.5	1.38 (35.0)	1.85 (47.0)	.63 (16.0)	.22 (5.6)	1.00 (25.4)	1.38 (35.0)	.69 (17.5)	.50 (12.7)	.93 (23.5)	.69 (17.5)	.31 (7.9)	(5.5) Dia. Thru (10) C Bore x (10) Deep M5x8 Soc. Hd. Screw	250-0040	1.18 (30.0)	1.36 (34.6)	.31 (7.9)	250-0276	1.77 (45.0)	1.26 (32.0)

Air Bleed Collar

Used With	Model	Part#
MC 150 M	SP-14	10781-000
MC 225 M	SP-20	10782-000
MC 600 M	SP-25	10783-000

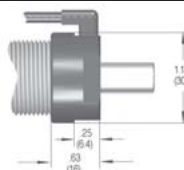

Clamp

Used With	Model	Part#
MC 600 M	MB-25	10780-000

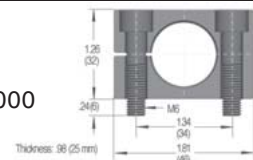

Miniature Shock Absorber Accessories
StopLight™

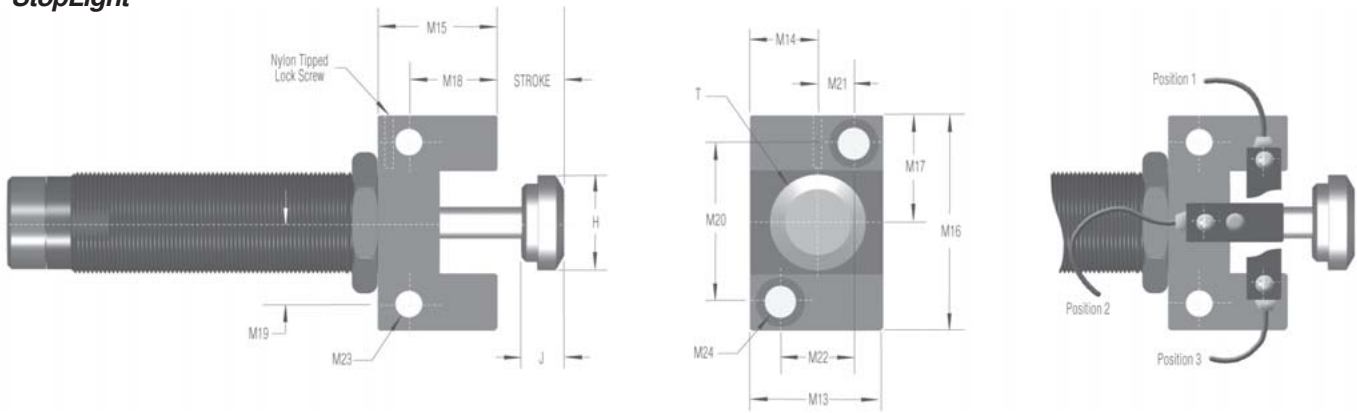

Mounting Block		IN INCHES (MILLIMETERS)														
Used With	Part #	T	H	J	M13	M14	M15	M16	M17	M18	M19	M20	M21	M22	M23	M24
MA 150 MC 150* SC 190	250-0377	9/16-18 UNF	.47 (11.9)	.43 (10.9)	.75 (19.0)	.38 (22.3)	.88 (22.3)	1.25 (31.8)	.63 (15.9)	.57 (14.5)	.44 (11.1)	.88 (22.2)	.19 (4.7)	.38 (9.5)	.180 (4.6)	.315 (8.0)
MC 150M* SC 190M	250-0378	M14x1.5														
MC 225* MA 225 MVC 225 SC 300	250-0379	3/4-16 UNF	.66 (16.8)	.43 (10.9)	.94 (23.8)	.47 (11.9)	.94 (23.8)	1.56 (39.6)	.78 (19.8)	.63 (16.0)	.55 (14.0)	1.10 (28.0)	.24 (6.0)	.47 (12.0)	.216 (5.5)	.394 (10.0)
MC 225M MA 225M MVC 225M SC 300M	250-0380	M20x1.5														
MC 600* MA 600 MVC 600 MA 900 MVC 900 SC 650 SC 925	250-0381	1-12 UNF	.90 (22.9)	.43 (10.9)	1.18 (30.0)	.59 (15.0)	1.00 (25.4)	1.75 (44.5)	.88 (22.3)	.63 (16.0)	.63 (16.0)	1.26 (32.0)	.31 (8.0)	.63 (16.0)	.216 (5.5)	.394 (10.0)
MC 600M* MA 600M MVC 600M MA 900M MVC 900M SC 650M SC 925M	250-0382	M25x1.5														

StopLight™ Switches are available in both NPN and PNP styles. Part numbers are 250-3 NPN and 250-3 PNP, respectively. The switches can be used with any StopLight mounting blocks.

* A complete StopLight assembly includes mounting block, proximity switch and steel button. Use the table below to order MC Series buttons. Steel buttons are an integral part of series MA and SC² and MVC units. Shock absorbers are ordered separately.

Model	Steel Button Part #
MA 150	250-0383
MC 150, MC 150M	250-0111
MC 225, MC 225M	250-0112
MC 600, MC 600M	250-0113

Specifications

250-3 NPN
 NPN-type Proximity Switch

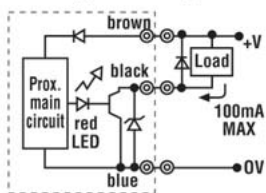

250-3 PNP
 PNP-type Proximity Switch

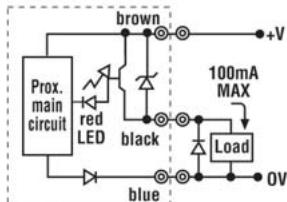

- Supply Voltage:** 10 to 27 VDC Ripple p to p 10% max
- Current Consumption:** 15mA max (at 24 VDC)
- Control Output:**
 - 3-Wire Output: 100mA max
 - Voltage Impression: 30 VDC max
 - Residual Voltage: 1 VDC max
- Operator Indicator:** Red LED. Power off = dark. Stand By = Dim Light. Detection = Bright Light.
- Operating Temperature:** 14° to 140° F, -10° to 60° C (At holding: 86° to 176° F; 30° to 80° C)
- Humidity:** 45 to 85% RH (At holding: 35 to 95% RH)
- Variation Due To Temperature Fluctuation:** ±20% max of detecting distance at 68° F (20° C) with a temperature range of 14° to 140° F (-10° to 60° C)
- Variation Due To Voltage Fluctuation:** ±5% max of detecting distance at 12/24/VDC when operated within 10 to 27 VDC
- Residual Voltage:** 1V max (Load current at 100mA)
- Insulation Resistance:** 10M Ω min (at 500 VDC)
- Dielectric Resistance:** 1,000VAC 50/60Hz for 1 minute
- Degree of Protection:** IP67 (IEC144)

Miniature Shock Absorber Side Load Adapters
For Side Load in Excess of 3°

With side load impact angles of more than 3° the operating lifetime of the shock absorber reduces rapidly due to increased wear of the rod bearings. The optional side load adapter provides a long lasting solution.

Material: Threaded body and plunger, hardened high tensile steel

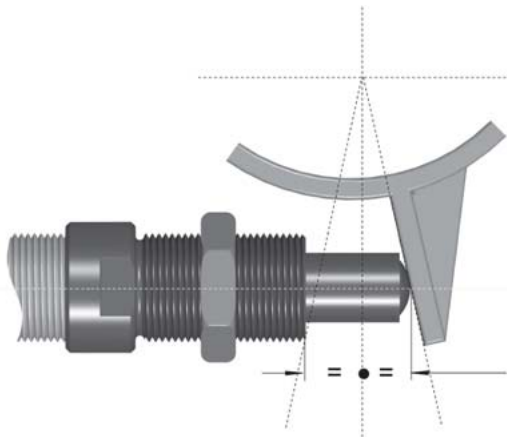
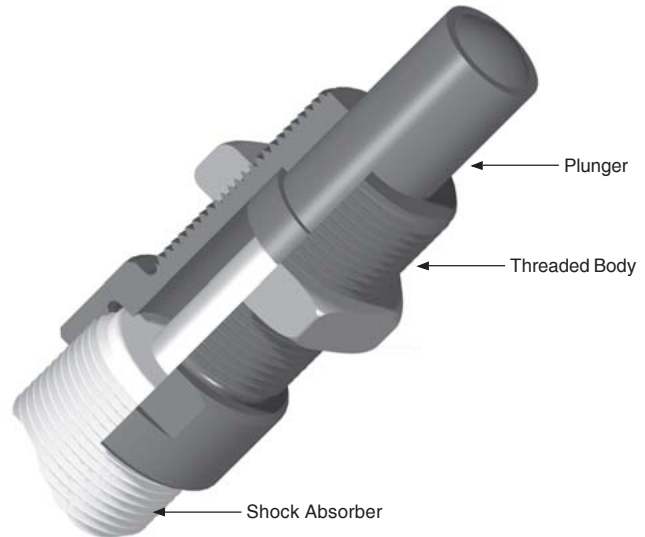

Problem: Rotary motion of the striking surface creates side load, which develops a bending moment on the piston rod. This can bend the rod in some cases. In all cases, side load will reduce seal and bearing life.

Solution: Use side load adapter.

Formula: $\alpha = \tan^{-1} \left(\frac{s}{2 \cdot R_s} \right)$ $R_{smin} = \frac{s}{2 \cdot \tan \alpha_{max}}$

Example: $s = .98$ (25mm) $\alpha_{max} = 25^\circ$ (adapter 250-0560)

$R_s = 3.94$ (100mm) $R_{smin} = \frac{.98}{2 \cdot \tan 25}$

$\alpha = \tan^{-1} \left(\frac{.98}{2 \cdot 3.94} \right)$ $R_{smin} = 1.05$ (27mm)

$\alpha = (7.09)^\circ$

α = angle of impact

α_{max} = maximum angle of impact

s = stroke

R_s = radius

R_{smin} = minimum r

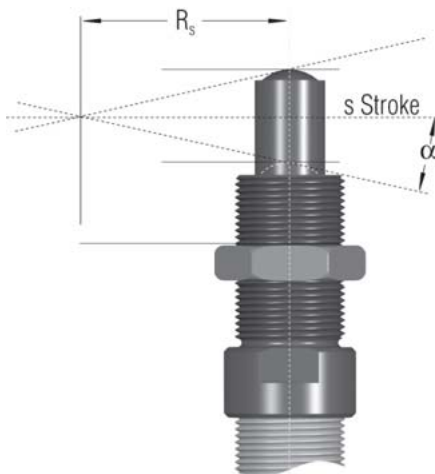

Miniature Shock Absorber Side Load Adapters

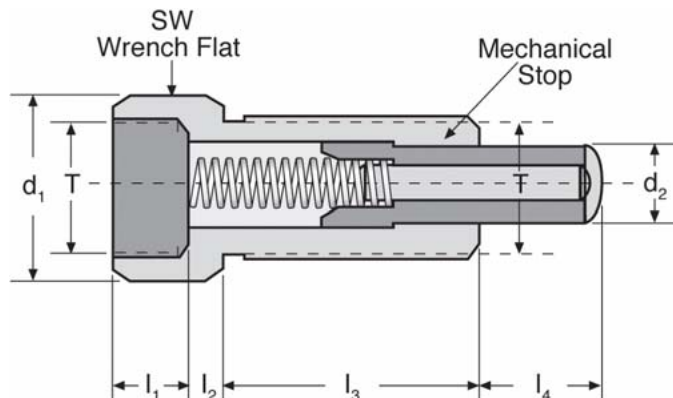

Dimensions IN INCHES (MILLIMETERS)												
MC, MVC Series Model	SC Series Model	MA Series Model	Side Load Adapter	T	d ₁	d ₂	l ₁	l ₂	l ₃	l ₄	SW	Maximum Side Load (α)
MC 150M	N/A	MA 150M	250-0558	M14 x 1.5	0.70 (18)	0.35 (9)	0.31 (8)	0.15 (4)	0.78 (20)	0.49 (12.5)	0.62 (16)	25°
MC 225M	N/A	N/A	250-0559	M20 x 1.5	0.94 (24)	0.47 (12)	0.39 (10)	0.15 (4)	0.78 (20)	0.49 (12.5)	0.86 (22)	25°
MC 600M	N/A	N/A	250-0560	M25 x 1.5	1.18 (30)	0.62 (16)	0.39 (10)	0.23 (6)	1.50 (38)	0.98 (25)	1.06 (27)	25°
N/A	SC190M-880*	N/A	250-0080	M14 x 1.5	0.70 (18)	0.35 (9)	0.39 (10)	0.15 (4)	1.02 (26)	0.62 (16)	0.62 (16)	25°
MVC 225M-880*	SC 300M-880*	MA 225M-880*	250-0081	M20 x 1.5	0.94 (24)	0.47 (12)	0.39 (10)	0.15 (4)	1.25 (32)	0.75 (19)	0.86 (22)	25°
MVC 600M-880*	SC 650M-880*	MA 600M-880*	250-0082	M25 x 1.5	1.18 (30)	0.62 (16)	0.39 (10)	0.23 (6)	1.50 (38)	0.98 (25)	1.06 (27)	25°

* The -880 = No button, standard rod

Note: Side load not to exceed 5". Maximum side load depends on application, shock absorber model, and stroke length.

Note: The side load adapter can only be installed on select metric shock absorbers without rod end button.

Magnum Series Group Accessories

Square and Rectangular Flanges IN INCHES (MILLIMETERS)									
Used With	Square Flange	Rect Flange	T	M1	M2	M3	M4	M5	M6
MA 33 ML 33 MC 33		250-0016	1-1/4-12 UNF	1.50 (38.1)	2.00 (50.8)	0.38 (9.5)	.219 (5.6)	1.12 (28.4)	1.62 (41.2)
MA 33M ML 33M MC 33M	N/A	250-0293	M33x1.5	1.62 (41.1)	2.12 (53.8)	0.38 (9.5)	.278 (7.1)	1.10 (28.0)	1.65 (42.0)
MA 36 ML 36 MC 36		250-0633	1-3/8-12 UNF	1.75 (44.4)	2.00 (50.8)	0.38 (9.5)	.219 (5.6)	1.12 (28.4)	1.62 (41.2)
MA 36M ML 36M MC 36M MA 45 ML 45 MC 45	N/A	N/A	N/A	N/A	N/A	N/A	N/A	N/A	N/A
MA 45M ML 45M MC 45M	250-0023	250-0024	1-3/4-12 UN	2.25 (57.2)	3.00 (76.2)	0.50 (12.7)	0.34 (8.7)	1.62 (41.2)	2.38 (60.5)
MA 45M ML 45M MC 45M	250-0298	250-0299	M45x1.5	2.25 (57.2)	3.00 (76.2)	0.50 (12.7)	0.35 (8.8)	1.62 (41.2)	2.38 (60.5)
MA 64 ML 64 MC 64	250-0028	N/A	2-1/2-12 UN	3.50 (88.9)	N/A	0.62 (15.9)	0.41 (10.4)	2.75 (69.6)	N/A
MA 64M ML 64M MC 64M	250-0302	N/A	M64x2	3.50 (88.9)	N/A	0.62 (15.9)	0.41 (10.4)	2.75 (69.6)	N/A

Square Flange

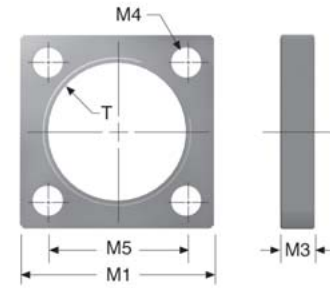

Rectangular Flange

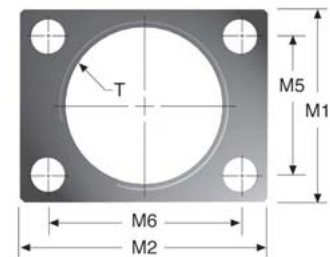

Stop Bars IN INCHES (MILLIMETERS)									
Used With	Part #	S10	S11	S12	S13	S14	S15	S16	S16
MA 33 ML 33 MC 33	250-0426	1.28 (32.5)	1.50 (38.1)	0.38 (9.7)	0.19 (4.8)	1.12 (28.4)	10-32 UNF	N/A	
MA 33M ML 33M MC 33M	250-0427	1.28 (32.5)	1.50 (38.1)	0.38 (9.7)	0.19 (4.8)	1.12 (28.4)	M5x0.8	N/A	
MA 36 ML 36 MC 36	250-0426	1.28 (32.5)	1.50 (38.1)	0.38 (9.7)	0.19 (4.8)	1.12 (28.4)	10-32 UNF	N/A	
MA 36M ML 36M MC 36M	N/A	N/A	N/A	N/A	N/A	N/A	N/A	N/A	
MA 45 ML 45 MC 45	250-0428	1.03 (26.2)	2.25 (57.2)	0.63 (16.0)	0.31 (7.9)	1.62 (41.3)	5/16-24 UNF	N/A	
MA 45M ML 45M MC 45M	250-0639	1.03 (26.2)	2.25 (57.2)	0.63 (16.0)	0.31 (7.9)	1.62 (41.3)	M8x1.25	N/A	
MA 6450 MA 64100 ML 6425 ML 6450 MC 6450 MC 64100	250-0430	1.44 (36.5)	3.50 (88.9)	0.50 (12.7)	0.25 (6.4)	2.75 (69.8)	3/8-24 UNF	1.37 (34.8)	
MA 6450M MA 64100M ML 6425M ML 6450M MC 6450M MC 64100M	250-0640	1.44 (36.5)	3.50 (88.9)	0.50 (12.7)	0.25 (6.4)	2.75 (69.8)	M10x1.5	1.37 (34.8)	
MA 64150 MC 64150	250-0432	2.31 (57.7)	3.50 (88.9)	0.50 (12.7)	0.25 (6.4)	2.75 (69.8)	3/8-24 UNF	1.37 (34.8)	
MA 64150M MC 64150M	250-0641	2.31 (57.7)	3.50 (88.9)	0.50 (12.7)	0.25 (6.4)	2.75 (69.8)	M10x1.5	1.37 (34.8)	
MAA 64150 MCA 64150	250-0435	2.18 (55.4)	3.50 (88.9)	0.50 (12.7)	0.25 (6.4)	2.75 (69.8)	3/8-24 UNF	1.37 (34.8)	
MAA 64150M MCA 64150M	250-0649	2.18 (55.4)	3.50 (88.9)	0.50 (12.7)	0.25 (6.4)	2.75 (69.8)	M10x1.5	1.37 (34.8)	

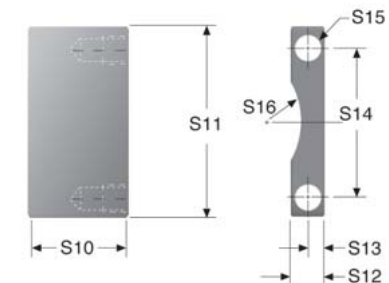
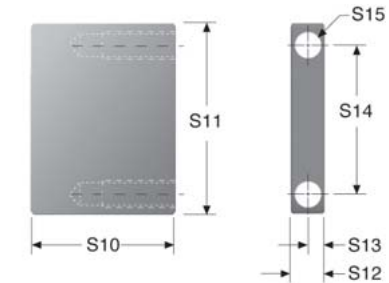

Hard metric stop bars available upon request.

Stop bars come in pairs, two bars per package.

Magnum Series Group Accessories

Flanged Stop Collars IN INCHES (MILLIMETERS)									
Used With	Part #	T	S1	S2	S3	S4	S5	S6	S7
MA 33 ML 33 MC 33	250-0070	1-1/4-12 UNF	2.00 (50.8)	1.50 (38.1)	2.50 (63.5)	2.00 (50.8)	0.88 (22.4)	0.25 (6.4)	0.282 (7.16)
MA 33M ML 33M MC 33M	250-0071	M33x1.5	2.00 (50.8)	1.50 (38.1)	2.50 (63.5)	2.00 (50.8)	0.88 (22.4)	0.25 (6.4)	0.282 (7.16)
MA 36 ML 36 MC 36 MA 36M ML 36M MC 36M	N/A	N/A	N/A	N/A	N/A	N/A	N/A	N/A	N/A
MA 45 ML 45 MC 45	250-0072	1-3/4-12 UN	1.85 (47.0)	2.25 (57.2)	3.25 (82.6)	2.75 (69.6)	0.88 (22.4)	0.25 (6.4)	0.282 (7.16)
MA 45M ML 45M MC 45M	250-0073	M45x1.5	1.85 (47.0)	2.25 (57.2)	3.25 (82.6)	2.75 (69.9)	0.88 (22.4)	0.25 (6.4)	0.282 (7.16)
MA 6450 MA 64100 ML 6425 ML 6450 MC 6450 MC 64100	250-0074	2-1/2-12 UN	2.25 (57.2)	3.00 (76.2)	4.25 (108.0)	3.50 (88.9)	1.00 (25.4)	0.38 (9.7)	0.282 (7.16)
MA 6450M MA 64100M ML 6425M ML 6450M MC 6450M MC 64100M	250-0075	M64x2	2.25 (57.2)	3.00 (76.2)	4.25 (108.0)	3.50 (88.9)	1.00 (25.4)	0.38 (9.7)	0.282 (7.16)
MA 64150 MC 64150	250-0076	2-1/2-12 UN	3.13 (79.4)	3.00 (76.2)	4.25 (108.0)	3.50 (88.9)	1.00 (25.4)	0.38 (9.7)	0.282 (7.16)
MA 64150M MC 64150M	250-0077	M64x2	3.13 (79.4)	3.00 (76.2)	4.25 (108.0)	3.50 (88.9)	1.00 (25.4)	0.38 (9.7)	0.282 (7.16)

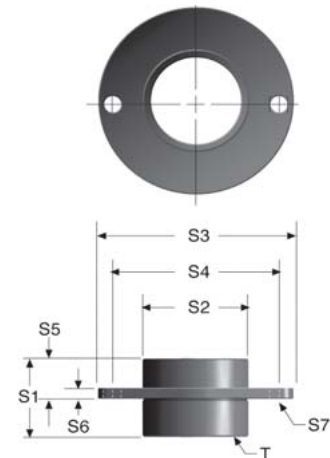

Lock Nuts IN INCHES (MILLIMETERS)				
Used With	Part #	T	W	N3
MA 33 ML 33 MC 33	250-0038	1-1/4-12 UN	1.50 (38.1)	0.25 (6.4)
MA 33M ML 33M MC 33M	250-0292	M33x1.5	1.56 (39.6)	0.25 (6.4)
MA 36 ML 36 MC 36	250-0631	1-3/8-12 UNF	1.75 (44.5)	0.25 (6.4)
MA 36M ML 36M MC 36M	250-0537	M36x1.5	1.75 (44.5)	0.25 (6.4)
MA 45 ML 45 MC 45	250-0041	1-3/4-12 UN	2.25 (57.2)	0.37 (9.4)
MA 45M ML 45M MC 45M	250-0297	M45x1.5	2.25 (57.2)	0.37 (9.4)
MA 64 ML 64 MC 64	250-0042	2-1/2-12 UN	3.00 (76.2)	0.37 (9.4)
MA 64M ML 64M MC 64M	250-0301	M64x2	3.00 (76.2)	0.37 (9.4)

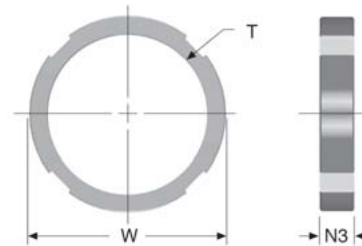

One lock nut included with each shock absorber where appropriate.



Side-Foot Mount Assembly



Side-Foot Mount Assembly			
Used With	Part #	Used With	Part #
MA 33 ML 33 MC 33	250-0015	MA 6450 MA 64100 ML 6425 ML 6450 MC 6450 MC 64100	250-0300
MA 33M ML 33M MC 33M	250-0294		
MA 36 ML 36 MC 36	N/A	MA 6450M MA 64100M ML 6425M ML 6450M MC 6450M MC 64100M	250-0304
MA 36M ML 36M MC 36M	N/A		
MA 45 ML 45 MC 45	250-0025	MA 64150 MC 64150	250-0030
MA 45M ML 45M MC 45M	250-0300	MA 64150M MC 64150M	250-0304

Note: See [pages 28, 30](#) and [32](#) for Mega Series side-foot mount drawings and dimensions.

Clevis Mount Assembly



Clevis Mount Assembly			
Used With	Part #	Used With	Part #
MA 33 ML 33 MC 33 MAS MLS MCS	250-0225	ML 6425 ML 6425M	250-0625 250-0626
MA 6450 ML 6450 MC 6450		MA 6450M ML 6450M MC 6450M	250-0625
MA 33M ML 33M MC 33M MAS 33M MLS 33M MCS 33M	250-0323	MA 64100 MC 64100	250-0626 250-0625
MA 64100M MC 64100M		MA 64150 MCN 64150 MAA 64150 MCA 64150	250-0626 250-0625
MAN 33 MLN 33 MCN 33 MAA 33 MLA 33 MCA 33	250-0018	MAN 64150M MCN 64150M MAA 64150M MCA 64150M	250-0626
MAN 33M MLN 33M MCN 33M MAA 33M MLA 33M MCA 33M	250-0322	MA 64150 MCA 64150 MAS 64150 MCS 64150	250-0627
MA 45 ML 45 MC 45	250-0324	MA 64150M MCA 64150M MAS 64150M MCS 64150M	250-0628
MA 45M ML 45M MC 45M	250-0325		

Note: See [pages 28, 30](#) and [32](#) for Mega Series clevis mount drawings and dimensions.

Air-Oil Tanks

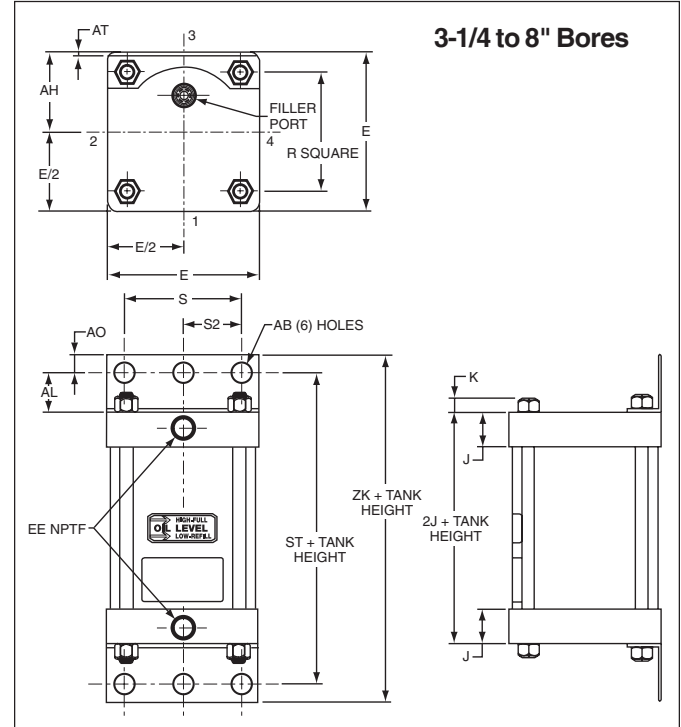
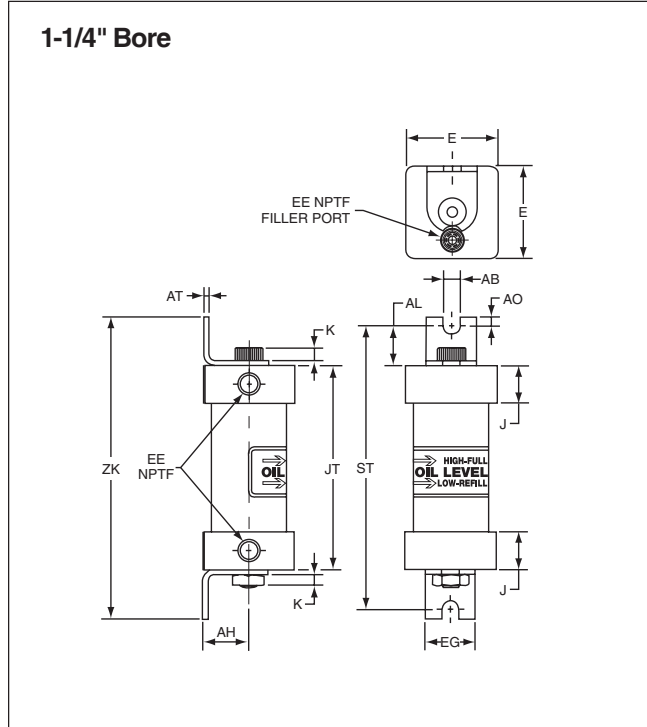

Dimensions															
Bore Size	E	J	K	R	S	AB	AH	AL	AO	AT	EE	ST	ZK	EG	JT
1 1/4	1 27/32	3/4	1/4	-	-	11/32	29/32	25.32	3/16	31/32	1/8	5 5/8	6	1	4 1/16
3 1/4	3 3/4	1 3/16	3/16	2.76	2 3/4	9/16	1 15/16	1 1/4	1/2	1/8	1/2	5	6	-	-
6	6 1/2	1.41	7/16	4.88	5 1/4	13/16	3 1/4	1 3/8	5/8	3/16	3/4	5 3/4	7	-	-
8	8 1/2	1.44	9/16	6.44	7 1/8	13/16	4 1/4	1 13/16	11/16	1/4	3/4	6 5/8	8	-	-

Mounting and Circuits

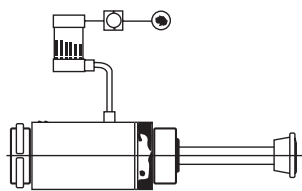

1. The piston rod is immediately returned to its extended position after completing the stroke.

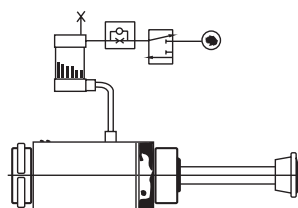

2. The piston rod remains in its retracted position until it is signaled to return. Special bleed-down type check valve is required for this circuit.

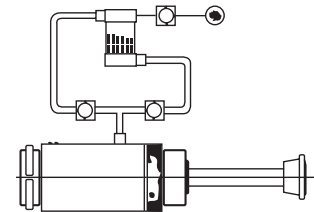

3. A recirculating cooling circuit allows warm oil to return to the tank while cool oil refills the shock absorber. A recirculating cooling circuit substantially increases the shock absorber's hourly energy capacity.

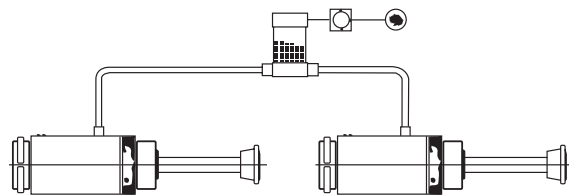

4. When connecting more than one shock absorber to an Air-Oil Tank, use caution in selecting the proper reservoir capacity. For two shock absorbers, the next largest Air-Oil Tank Size is usually adequate.

Capacity (Maximum)				
Model	Oil Temp (°F)	Max. Pressure (psi)	Capacity (cubic inches)	Recommended shock absorber size
1.25CB3TKU x 2.00	200	100	2.4	MC 3325 MC 3350
3.25CB3TKU x 5.00	200	100	41.4	MC 4525 MC 64150
6.00CB3TKU x 9.00	200	100	254.5	1-1/2 x 5 - 3 x 12
8.00CB3TKU x 15.00	200	100	754	4 x 6 - 4 x 16
8.00 CB3TKUS x 15.00	200	100	754	4 x 6 - 4 x 16

S = 1 1/2 NPTF ports in cap face

Offer of Sale

The items described in this document and other documents or descriptions provided by Parker Hannifin Corporation, its subsidiaries and Divisions ("Company") and its authorized distributors, are hereby offered for sale at prices to be established by the Company, its subsidiaries and its authorized distributors. This offer and its acceptance by any customer ("Buyer") shall be governed by all of the following Terms and Conditions. Buyer's order for any such item, when communicated to the Company, its subsidiary or an authorized distributor ("Seller") verbally or in writing, shall constitute acceptance of this offer.

1. Terms and Conditions of Sale: All descriptions, quotations, proposals, offers, acknowledgments, acceptances and sales of Seller's products are subject to and shall be governed exclusively by the terms and conditions stated herein. Buyer's acceptance of any offer to sell is limited to these terms and conditions. Any terms or conditions in addition to, or inconsistent with those stated herein, proposed by Buyer in any acceptance of an offer by Seller, are hereby objected to. No such additional, different or inconsistent terms and conditions shall become part of the contract between Buyer and Seller unless expressly accepted in writing by Seller. Seller's acceptance of any offer to purchase by Buyer is expressly conditional upon Buyer's assent to all the terms and conditions stated herein, including any terms in addition to, or inconsistent with those contained in Buyer's offer. Acceptance of Seller's products shall in all events constitute such assent.

2. Payment: Payment shall be made by Buyer net 30 days from the date of delivery of the items purchased hereunder. Amounts not timely paid shall bear interest at the maximum rate permitted by law for each month or portion thereof that the Buyer is late in making payment. Any claims by Buyer for omissions or shortages in a shipment shall be waived unless Seller receives notice thereof within 30 days after Buyer's receipt of the shipment.

3. Delivery: Unless otherwise provided on the face hereof, delivery shall be made F.O.B. Seller's plant. Regardless of the method of delivery, however, risk of loss shall pass to Buyer upon Seller's delivery to a carrier. Any delivery dates shown are approximate only and Seller shall have no liability for any delays in delivery.

4. Warranty: Seller warrants that the items sold hereunder shall be free from defects in material or workmanship for a period of 18 months from date of shipment from the Company. **THIS WARRANTY COMPRISES THE SOLE AND ENTIRE WARRANTY PERTAINING TO ITEMS PROVIDED HEREUNDER. SELLER MAKES NO OTHER WARRANTY, GUARANTEE, OR REPRESENTATION OF ANY KIND WHATSOEVER. ALL OTHER WARRANTIES, INCLUDING BUT NOT LIMITED TO, MERCHANTABILITY AND FITNESS FOR PURPOSE, WHETHER EXPRESS, IMPLIED, OR ARISING BY OPERATION OF LAW, TRADE USAGE, OR COURSE OF DEALING ARE HEREBY DISCLAIMED.**

NOTWITHSTANDING THE FOREGOING, THERE ARE NO WARRANTIES WHATSOEVER ON ITEMS BUILT OR ACQUIRED WHOLLY OR PARTIALLY, TO BUYER'S DESIGN OR SPECIFICATIONS.

5. Limitation of Remedy: SELLER'S LIABILITY ARISING FROM OR IN ANY WAY CONNECTED WITH THE ITEMS SOLD OR THIS CONTRACT SHALL BE LIMITED EXCLUSIVELY TO REPAIR OR REPLACEMENT OF THE ITEMS SOLD OR REFUND OF THE PURCHASE PRICE PAID BY BUYER, AT SELLER'S SOLE OPTION. IN NO EVENT SHALL SELLER BE LIABLE FOR ANY INCIDENTAL, CONSEQUENTIAL OR SPECIAL DAMAGES OF ANY KIND OR NATURE WHATSOEVER, INCLUDING BUT NOT LIMITED TO LOST PROFITS ARISING FROM OR IN ANY WAY CONNECTED WITH THIS AGREEMENT OR ITEMS SOLD HEREUNDER, WHETHER ALLEGED TO ARISE FROM BREACH OF CONTRACT, EXPRESS OR IMPLIED WARRANTY, OR IN TORT, INCLUDING WITHOUT LIMITATION, NEGLIGENCE, FAILURE TO WARN OR STRICT LIABILITY.

6. Changes, Reschedules and Cancellations: Buyer may request to modify the designs or specifications for the items sold hereunder as well as the quantities and delivery dates thereof, or may request to cancel all or part of this order, however, no such requested modification or cancellation shall become part of the contract between Buyer and Seller unless accepted by Seller in a written amendment to this Agreement. Acceptance of any such requested modification or cancellation shall be at Seller's discretion, and shall be upon such terms and conditions as Seller may require.

7. Special Tooling: A tooling charge may be imposed for any special tooling, including without limitations, dies, fixtures, molds and patterns, acquired to manufacture items sold pursuant to this contract. Such special tooling shall be and remain Seller's property notwithstanding payment of any charges by Buyer. In no event will Buyer acquire any interest in apparatus belonging to Seller which is utilized in the manufacture of the items sold hereunder, even if such apparatus has been specially converted or adapted for such manufacture and notwithstanding any charges paid by Buyer. Unless otherwise agreed, Seller shall have the right to alter, discard or otherwise dispose of any special tooling or other property in its sole discretion at any time.

8. Buyer's Property: Any designs, tools, patterns, materials, drawings, confidential information or equipment furnished by Buyer, or any other items which become Buyer's property, may be considered obsolete and may be destroyed by Seller after two (2) consecutive years have elapsed without Buyer placing an order for the items which are manufactured using such property. Seller shall not be responsible for any loss or damage to such property while it is in Seller's possession or control.

9. Taxes: Unless otherwise indicated on the face hereof, all prices and charges are exclusive of excise, sales, use, property, occupational or like taxes which may be imposed by any taxing authority upon the manufacture, sale or delivery of the items sold hereunder. If any such taxes must be paid by Seller or if Seller is liable for the collection of such tax, the amount thereof shall be in addition to the amounts for the items sold. Buyer agrees to pay all such taxes or to reimburse Seller therefore upon receipt of its invoice. If Buyer claims exemption from any sales, use or other tax imposed by any taxing authority, Buyer shall save Seller harmless from and against any such tax, together with any interest or penalties thereon which may be assessed if the items are held to be taxable.

10. Indemnity For Infringement of Intellectual Property Rights: Seller shall have no liability for infringement of any patents, trademarks, copyrights, trade dress, trade secrets or similar rights except as provided in this Part 10. Seller will defend and indemnify Buyer against allegations of infringement of U.S. patents, U.S. trademarks, copyrights, trade dress and trade secrets (hereinafter "Intellectual Property Rights"). Seller will defend at its expense and will pay the cost of any settlement or damages awarded in an action brought against Buyer based on an allegation that an item sold pursuant to this contract infringes the Intellectual Property Rights of a third party. Seller's obligation to defend and indemnify Buyer is contingent on Buyer notifying Seller within ten (10) days after Buyer becomes aware of such allegations of infringement, and Seller having sole control over the defense of any allegations or actions including all negotiations for settlement or compromise. If an item sold hereunder is subject to a claim that it infringes the Intellectual Property Rights of a third party, Seller may, at its sole expense and option, procure for Buyer the right to continue using said item, replace or modify said item so as to make it noninfringing, or offer to accept return of said item and return the purchase price less a reasonable allowance for depreciation. Notwithstanding the foregoing, Seller shall have no liability for claims of infringement based on information provided by Buyer, or directed to items delivered hereunder for which the designs are specified in whole or part by Buyer, or infringements resulting from the modification, combination or use in a system of any item sold hereunder. The foregoing provisions of this Part 10 shall constitute Seller's sole and exclusive liability and Buyer's sole and exclusive remedy for infringement of Intellectual Property Rights.

If a claim is based on information provided by Buyer or if the design for an item delivered hereunder is specified in whole or in part by Buyer, Buyer shall defend and indemnify Seller for all costs, expenses or judgements resulting from any claim that such item infringes any patent, trademark, copyright, trade dress, trade secret or any similar right.

11. Force Majeure: Seller does not assume the risk of and shall not be liable for delay or failure to perform any of Seller's obligations by reason of circumstances beyond the reasonable control of Seller (hereinafter "Events of Force Majeure"). Events of Force Majeure shall include without limitation, accidents, acts of God, strikes or labor disputes, acts, laws, rules or regulations of any government or government agency, fires, floods, delays or failures in delivery of carriers or suppliers, shortages of materials and any other cause beyond Seller's control.

12. Entire Agreement/Governing Law: The terms and conditions set forth herein, together with any amendments, modifications and any different terms or conditions expressly accepted by Seller in writing, shall constitute the entire Agreement concerning the items sold, and there are no oral or other representations or agreements which pertain thereto. This Agreement shall be governed in all respects by the law of the State of Ohio. No actions arising out of sale of the items sold hereunder or this Agreement may be brought by either party more than two (2) years after the cause of action accrues.

NOTES

NOTES

Extensive Automation Solutions

HMI and Controllers



Superior integration and support for machine control as well as HMI hardware and software.

www.parker.com/em/hmicont

Electric Actuators



Screw, belt-driven, and linear motor actuators for the complete range of industrial applications, offering precise motion and flexibility.

www.parker.com/em/linear

Motors and Drives



Parker's family of innovative servo/stepper motors and drives continues to expand to meet the challenges of new technologies.

www.parker.com/em/motordrive

Linear Actuators



Aluminum and steel pneumatic cylinders, guided cylinders, rodless cylinders, and short stroke thrusters from the industry leader.

www.parker.com/pneu/linear

Rotary Actuators



Industry leader in the design and manufacture of pneumatic rack and pinion, and vane-style rotary actuators.

www.parker.com/pneu/rotary

Vacuum Products and Sensors



Vacuum solutions include a broad range of generators (integrated/inline), cups, and pressure sensors.

www.parker.com/pneu/vacsen

Grippers



Parallel, angular, and three jaw grippers are available in over 1,000 configurations.

www.parker.com/pneu/gripper

Airline Accessories



Airline accessories include silencers, flow controls, and mufflers to round out Parker's pneumatic solution.

www.parker.com/pneu/access

Air Control Valves



Valve technology that meets the most demanding requirements in any industrial application.

www.parker.com/pneu/valve

Air Preparation



Parker, the industry leader in air preparation, offers a complete line of products to ensure clean, dry, oil-free air.

www.parker.com/pneu/airprep

Connectors and Tubing



The most complete line of fluid connectors worldwide will meet virtually any automation application.

www.parker.com/pneu/fc

Parker IPS Structural Automation



More than 150 metric and inch profiles, integral motion components, and accessories for unlimited and flexible configurations. Pre-machined kits or complete assemblies.

www.parker.com/ips

Covering Electromechanical and Pneumatic markets, each of our catalogs is paired with an interactive CD. Call for your comprehensive guides today. 800-C-Parker



Electromechanical Precision Bulletin AU01-5000/US

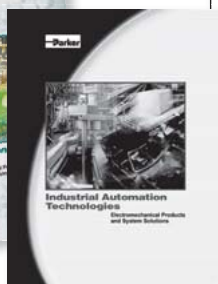

Electromechanical Industrial Bulletin AU01-7500/US

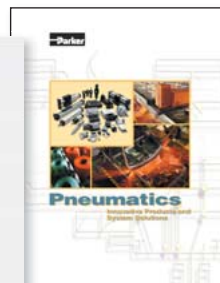

Pneumatic Bulletin AU01-1000/US





Parker Hannifin Corporation
Actuator Division
135 Quadral Drive
Wadsworth, OH 44281 USA
Phone: 330-336-3511
Fax: 330-334-3335
www.parker.com/pneumatics

Parker Hannifin Canada
Motion and Control Division
160 Chisholm Drive
Milton, Ontario
Canada L9T 3G9
Phone: 905-693-3000
Fax: 905-876-1958

Catalog AU08-1022-1/NA
02/07