

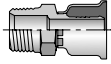







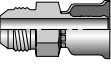
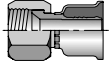
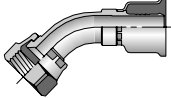
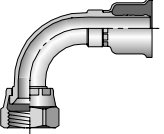
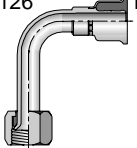

 NPTF Pipe	10126 B-11  <i>Male - Rigid</i>	 JIC 37°	10326 B-11  <i>Male - Rigid</i>	10626 B-12  <i>Female - Swivel</i>	13726 B-12  <i>Female - Swivel 45° Elbow - Short</i>
13926 B-12  <i>Female - Swivel 90° Elbow - Short</i>	14126 B-13  <i>Female - Swivel 90° Elbow - Long</i>	 SAE 45°	10426 B-13  <i>Male - Rigid</i>	10826 B-13  <i>Female - Swivel</i>	17726 B-13  <i>Female - Swivel 45° Elbow</i>
17926 B-14  <i>Female - Swivel 90° Elbow</i>	 JIC 37°/ SAE 45° Dual Flare	16826 B-14  <i>Female - Swivel</i>	 Inverted Flare	12826 B-14  <i>Male - Swivel</i>	16726 B-15  <i>Male - Swivel 45° Elbow</i>
16926 B-15  <i>Male - Swivel 90° Elbow</i>	 Seal-Lok® (O-Ring Face Seal)	1JC26 B-15  <i>Female - Swivel Short</i>	1J726 B-16  <i>Female - Swivel 45° Elbow</i>	1J926 B-16  <i>Female - Swivel 90° Elbow - Short</i>	 Tube-O
1S526 B-16  <i>Male - Swivel Short Pilot</i>	1S526-PR B-17  <i>Male - Swivel Short Pilot</i>	15R26 B-17  <i>Male - Swivel 45° Elbow - Short Pilot</i>	15K26 B-17  <i>Male - Swivel 90° Elbow - Short Pilot</i>	15K26-PB B-17  <i>Male - Swivel 90° Elbow - Short Pilot</i>	15K26-PR B-18  <i>Male - Swivel 90° Elbow - Short Pilot</i>
14526-PR B-18  <i>Male - Swivel Long Pilot</i>	14526-PT B-18  <i>Male - Swivel Long Pilot</i>	15M26-PR B-18  <i>Male - Swivel 90° Elbow - Long Pilot</i>	15M26-PT B-19  <i>Male - Swivel 90° Elbow - Long Pilot</i>	15G26 B-19  <i>Male - Rigid Internal - Long Pilot</i>	15G26-PR B-19  <i>Male - Rigid Internal - Long Pilot</i>
15S26 B-19  <i>Female - Swivel Short Pilot</i>	15H26 B-20  <i>Female - Swivel 45° Elbow - Short Pilot</i>	15T26 B-20  <i>Female - Swivel 90° Elbow - Short Pilot</i>	15926-PB B-20  <i>Female - Swivel Long Pilot</i>	15926-PT B-20  <i>Female - Swivel Long Pilot</i>	15N26-PB B-21  <i>Female - Swivel 45° Elbow - Long Pilot</i>
15N26-PT B-21  <i>Female - Swivel 45° Elbow - Long Pilot</i>	15L26 B-21  <i>Female - Swivel 90° Elbow - Long Pilot</i>	15L26-PB B-21  <i>Female - Swivel 90° Elbow - Long Pilot</i>	15L26-PR B-22  <i>Female - Swivel 90° Elbow - Long Pilot</i>	15L26-PT B-22  <i>Female - Swivel 90° Elbow - Long Pilot</i>	15P26-PT B-22  <i>Male - Swivel 45° Elbow - Long Pilot</i>

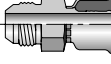
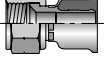
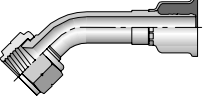
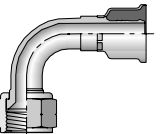
A

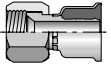

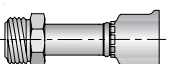
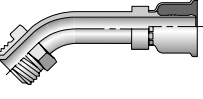
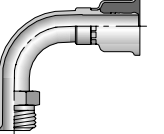

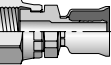
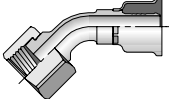
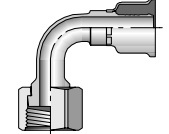
B

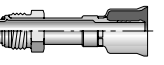
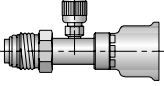
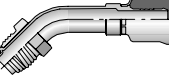
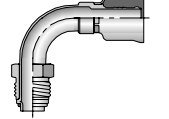
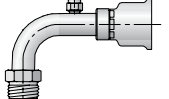
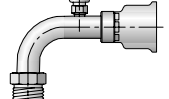
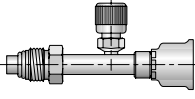
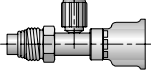
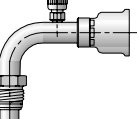
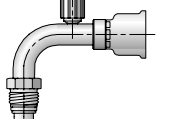
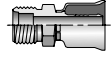
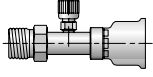
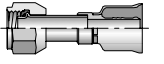
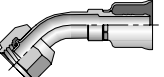
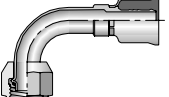
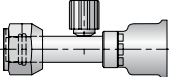
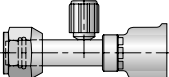
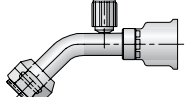
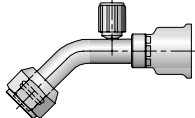
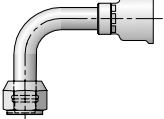
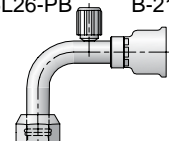
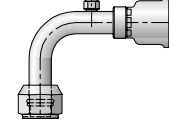
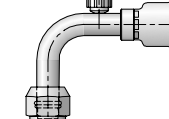
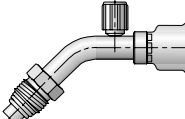
C

D

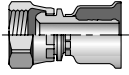
E

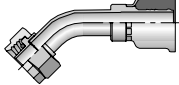
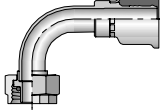
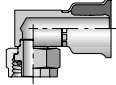
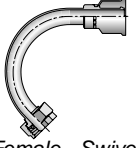
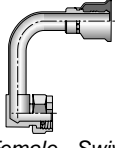
A

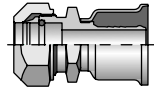
 <p>Air Brake Jounce Line</p>	<p>17B26 B-22</p>  <p><i>Female - Swivel</i></p>	 <p>Compressor</p>	<p>15V26 B-23</p>  <p><i>Female - Swivel 45° Elbow</i></p>	<p>15W26 B-23</p>  <p><i>Female - Swivel 90° Elbow</i></p>	<p>15Z26 B-23</p>  <p><i>Female - Swivel 90° Elbow - Block Type</i></p>
<p>1RV26 B-23</p>  <p><i>Female - Swivel 135° Elbow</i></p>	<p>1RZ26 B-24</p>  <p><i>Female - Swivel 180° Elbow</i></p>	 <p>Refrigerant Tube Mender</p>	<p>1T126 B-24</p>  <p><i>Male (w/Nut & Ferrule)</i></p>	<p>1T126 B-25</p> <p><i>Fitting Assembly Instructions</i></p>	

B

C

D

E

10126
Male NPTF Pipe - Rigid

# Part Number	Thread inch	Hose I.D. inch	A		H		B		Additional Material Brass (B)
			inch	mm	inch	mm	inch	mm	
10126-2-4	1/8x27	3/16	1.65	42	7/16	0.78	0.78	20	
10126-4-4	1/4x18	3/16	1.88	48	9/16	1.01	1.01	26	
10126-4-5	1/4x18	1/4	1.88	48	9/16	1.01	1.01	26	
10126-4-6	1/4x18	5/16	1.88	48	3/4	1.02	1.02	26	•
10126-6-6	3/8x18	5/16	1.89	48	11/16	1.03	1.03	26	•
10126-6-8	3/8x18	13/32	1.89	48	11/16	1.03	1.03	26	•
10126-8-8	1/2x14	13/32	2.14	54	7/8	1.28	1.28	33	•
10126-8-10	1/2x14	1/2	2.25	57	7/8	1.30	1.30	33	•
10126-12-12	3/4x14	5/8	2.31	59	1-1/16	1.37	1.37	35	•
10126-16-16	1x11-1/2	7/8	2.61	66	1-3/8	1.57	1.57	40	
10126-20-20	1-1/4x11-1/2	1-1/8	2.83	72	1-3/4	1.77	1.77	45	
10126-24-24	1-1/2x11-1/2	1-3/8	3.01	76	2	1.93	1.93	49	
10126-32-32	2x11-1/2	1-13/16	3.44	87	2-1/2	2.18	2.18	55	

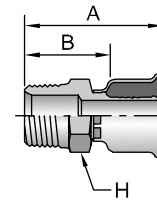

10326
Male JIC 37° - Rigid

# Part Number	Thread inch		Hose I.D. inch	A		H		B		Additional Material Brass (B)
	inch	mm		inch	mm	inch	mm			
10326-4-4	1/4	7/16x20	3/16	2.02	50	1/2	1.15	1.15	29	•
10326-6-6	3/8	9/16x18	5/16	2.12	54	3/4	1.26	1.26	32	•
10326-8-8	1/2	3/4X16	13/32	1.94	49	13/16	1.08	1.08	27	•
10326-10-10	5/8	7/8X14	1/2	2.49	64	15/16	1.54	1.54	39	•
10326-16-16	1	1-5/16x12	7/8	2.79	71	1-3/8	1.75	1.75	44	

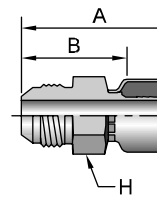

10626 Female JIC 37° - Swivel

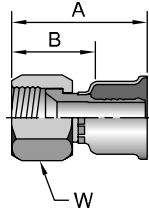

# Part Number	Thread		Hose I.D. inch	A		W inch	B		Additional Material Brass (B)
	inch	mm		inch	mm		inch	mm	
10626-6-6	3/8	9/16x18	5/16	1.81	45	11/16	0.95	23	•
10626-6-8	3/8	9/16x18	13/32	1.67	52	11/16	1.19	30	•
10626-12-12	3/4	1-1/16x12	5/8	2.29	58	1-1/4	1.35	34	•
10626-16-16	1	1-5/16x12	7/8	2.53	64	1-1/2	1.49	38	•
10626-20-20	1-1/4	1-5/8x12	1-1/8	2.56	65	2	1.50	38	•
10626-24-24	1-1/2	1-7/8x12	1-3/8	2.77	70	2-1/4	1.69	43	
10626-32-32	2	2-1/2x12	1-13/16	3.30	84	2-7/8	2.04	52	

13726 Female JIC 37° - Swivel - 45° Elbow - Short Drop

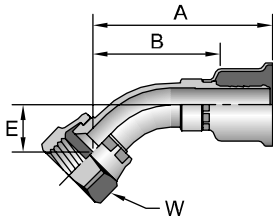

# Part Number	Thread		Hose I.D. inch	A		E		W inch	B	
	inch	mm		inch	mm	inch	mm		inch	mm
13726-4-4	1/4	7/16x20	3/16	2.01	51	0.39	10	9/16	1.14	29
13726-6-6	3/8	9/16x18	5/16	2.72	69	0.43	11	11/16	1.86	47
13726-8-8	1/2	3/4x16	13/32	2.82	72	0.55	15	7/8	1.96	50
13726-10-10	5/8	7/8x14	1/2	2.96	75	0.63	16	1	2.01	51
13726-12-12	3/4	1-1/16x12	5/8	3.44	87	0.83	21	1-1/4	2.50	63
13726-16-16	1	1-5/16x12	7/8	3.34	85	0.90	23	1-1/2	2.30	58
13726-20-20	1-1/4	1-5/8x12	1-1/8	3.74	95	1.18	30	2	2.68	68
13726-24-24	1-1/2	1-7/8x12	1-3/8	3.92	100	1.16	29	2-1/4	2.84	72

13926 Female JIC 37° - Swivel - 90° Elbow - Short Drop

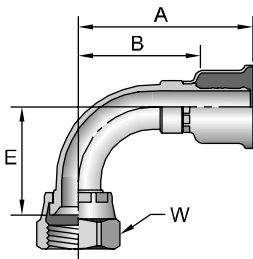

# Part Number	Thread		Hose I.D. inch	A		E		W inch	B	
	inch	mm		inch	mm	inch	mm		inch	mm
13926-4-4	1/4	7/16x20	3/16	1.82	46	0.83	21	9/16	0.95	24
13926-6-6	3/8	9/16x18	5/16	2.15	55	0.91	23	11/16	1.29	33
13926-8-8	1/2	3/4x16	13/32	2.22	56	1.09	28	7/8	1.36	35
13926-10-10	5/8	7/8x14	1/2	2.23	57	1.26	32	1	1.28	33
13926-10-12	5/8	7/8x14	5/8	2.52	64	1.23	31	1	1.58	40
13926-12-12	3/4	1-1/16x12	5/8	2.28	58	1.82	46	1-1/4	1.30	34
13926-16-16	1	1-5/16x12	7/8	3.30	84	2.14	54	1-1/2	2.26	57
13926-20-20	1-1/4	1-5/8x12	1-1/8	3.60	91	2.57	65	2	2.53	65
13926-24-24	1-1/2	1-7/8x12	1-3/8	3.92	100	2.82	72	2-1/4	2.84	72

14126

Female JIC 37° - Swivel - 90° Elbow - Long Drop

# Part Number	Thread		Hose I.D. inch	A		E		W inch	B	
	inch	inch		inch	mm	inch	mm		inch	mm
14126-4-4	1/4	7/16x20	1/4	2.05	52	1.81	46	9/16	1.18	30
14126-6-6	3/8	9/16x18	5/16	2.02	51	2.13	54	11/16	1.16	29
14126-8-8	1/2	3/4X16	13/32	2.35	60	2.43	62	7/8	1.49	38
14126-10-10	5/8	7/8x14	1/2	2.11	54	2.76	70	1	1.16	29
14126-16-16	1	1-5/16x12	7/8	3.17	81	4.33	110	1-1/2	2.13	54

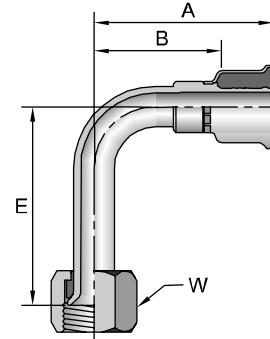

10426

Male SAE 45° - Rigid

# Part Number	Thread		Hose I.D. inch	A		H inch	B	
	inch	inch		inch	mm		inch	mm
10426-4-4	1/4	7/16x20	3/16	1.97	50	1/2	1.18	28
10426-6-6	3/8	5/8x18	5/16	2.04	52	11/16	1.18	30

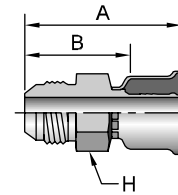

10826

Female SAE 45° - Swivel

# Part Number	Thread		Hose I.D. inch	A		W inch	B		Additional Material Brass (B)
	inch	inch		inch	mm		inch	mm	
10826-6-6	3/8	5/8x18	5/16	1.84	47	3/4	0.98	25	•
10826-10-8	5/8	7/8x14	13/32	2.21	56	1	1.35	34	
10826-10-10	5/8	7/8x14	1/2	2.13	54	1	1.18	30	
10826-12-12	3/4	1-1/16x14	5/8	2.19	56	1-1/4	1.25	32	•

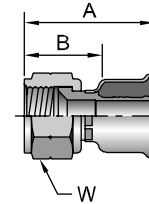

17726

Female SAE 45° - Swivel - 45° Elbow

# Part Number	Thread		Hose I.D. inch	A		E		W inch	B	
	inch	inch		inch	mm	inch	mm		inch	mm
17726-4-4	1/4	7/16x20	3/16	2.29	58	0.39	10	9/16	1.43	36
17726-6-6	3/8	5/8x18	5/16	2.72	69	0.43	11	11/16	1.86	47
17726-8-8	1/2	3/4x16	13/32	2.82	72	0.59	14	7/8	1.96	50
17726-10-10	5/8	7/8x14	1/2	2.96	75	0.63	16	1	2.01	51
17726-12-12	3/4	1-1/16x14	5/8	3.43	87	0.83	21	1-1/4	2.49	63

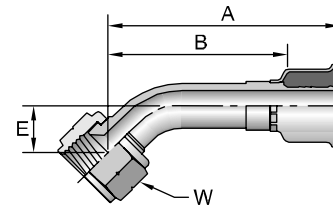

Notch on nut signifies SAE 45° flare fitting.



17926

Female SAE 45° - Swivel - 90° Elbow

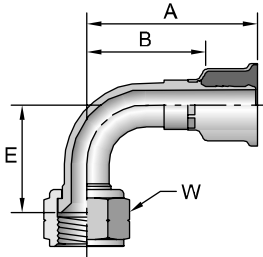

# Part Number	Thread		Hose I.D. inch	A		E		W inch	B	
	inch	mm		inch	mm	inch	mm		inch	mm
17926-4-4	1/4	7/16x20	3/16	1.75	44	0.83	21	9/16	0.89	23
17926-6-6	3/8	5/8x18	5/16	2.15	55	0.91	23	3/4	1.29	33
17926-8-8	1/2	3/4x16	13/32	2.31	58.7	1.00	25.4	7/8	1.45	37
17926-10-10	5/8	7/8x14	1/2	2.23	57	1.26	32	1	1.28	33
17926-12-12	3/4	1-1/16x14	5/8	2.28	58	1.82	46	1-1/4	1.34	34

Notch on nut signifies 45° flare fitting.

16826

Female JIC 37° / SAE 45° - Dual Flare - Swivel

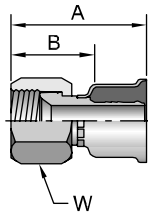

# Part Number	Thread		Hose I.D. inch	A		W inch	B		Additional Material Brass (B)
	inch	mm		inch	mm		inch	mm	
16826-4-4	1/4	7/16x20	3/16	1.67	42	9/16	0.80	20	•
16826-4-5	1/4	7/16x20	1/4	1.55	48	9/16	1.03	26	
16826-4-6	1/4	7/16x20	5/16	1.55	39	9/16	0.07	17	
16826-5-5	5/16	1/2x20	1/4	1.77	45	5/8	0.90	23	
16826-8-6	1/2	3/4x16	5/16	1.76	56	7/8	1.34	34	
16826-8-8	1/2	3/4x16	13/32	1.91	49	7/8	1.05	27	
16826-8-10	1/2	3/4x16	1/2	2.36	60	7/8	1.41	36	•
16826-10-10	5/8	7/8x14	1/2	2.17	55	1	1.23	31	•
16826-10-12	5/8	7/8x14	5/8	1.96	61	1	1.53	37	

12826

Male Inverted SAE 45° - Swivel

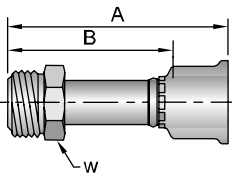

# Part Number	Thread		Hose I.D. inch	A		W inch	B	
	inch	mm		inch	mm		inch	mm
12826-4-4	1/4	7/16x24	3/16	2.43	62	7/16	1.56	40
12826-5-5	5/16	1/2x20	1/4	2.56	65	1/2	1.69	43
12826-6-6	3/8	5/8x18	5/16	2.87	73	5/8	2.01	51
12826-8-8	1/2	3/4x18	13/32	3.00	76	3/4	2.14	54
12826-10-10	5/8	7/8x18	1/2	3.17	81	7/8	2.22	56

See Accessories Section for O-Rings and Flange Kits.

16726

Male Inverted SAE 45° - Swivel - 45° Elbow

# Part Number	Thread		Hose I.D. inch	A		E		W		B	
	inch			inch	mm	inch	mm	inch	inch	inch	mm
16726-4-4	1/4	7/16x24	3/16	2.20	56	0.63	16	7/16	1.33	34	
16726-5-5	5/16	1/2x20	1/4	2.30	58	0.70	18	1/2	1.43	36	
16726-6-6	3/8	5/8x18	5/16	2.55	65	0.87	22	5/8	1.69	43	
16726-8-8	1/2	3/4x18	13/32	2.60	66	1.09	28	3/4	1.74	44	

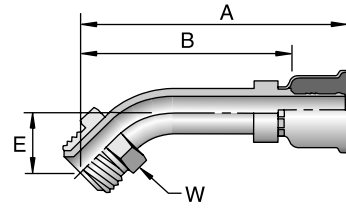

16926

Male Inverted SAE 45° - Swivel - 90° Elbow

# Part Number	Thread		Hose I.D. inch	A		E		W		B	
	inch			inch	mm	inch	mm	inch	inch	inch	mm
16926-4-4	1/4	7/16x24	3/16	2.27	58	1.56	40	7/16	1.40	36	
16926-6-6	3/8	5/8x18	5/16	1.89	48	1.48	38	5/8	1.03	26	
16926-8-8	1/2	3/4x18	13/32	2.25	57	1.88	48	3/4	1.39	35	
16926-10-10	5/8	7/8x18	1/2	2.70	69	2.17	55	7/8	1.75	44	

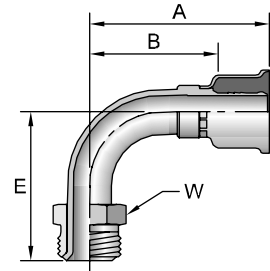

1JC26

Female Seal-Lok® - Swivel - Short

# Part Number	Thread		Hose I.D. inch	A		C		H		W		B	
	inch			inch	mm	inch	mm	inch	inch	inch	mm	inch	mm
1JC26-4-4	1/4	9/16x18	3/16	1.66	42	0.31	8	9/16	11/16	0.79	20		
1JC26-6-6	3/8	11/16x16	5/16	1.70	43	0.34	9	11/16	13/16	0.84	21		
1JC26-8-8	1/2	13/16x16	13/32	1.76	45	0.43	11	13/16	15/16	0.90	23		
1JC26-12-12	3/4	1-3/16x12	5/8	2.13	54	0.55	14	1-1/8	1-3/8	1.19	30		
1JC26-16-16	1	1-7/16x12	7/8	2.39	61	0.56	14	1-3/8	1-5/8	1.35	34		
1JC26-20-20	1-1/4	1-11/16x12	1-1/8	2.45	62	0.59	15	1-7/8	1-7/8	1.39	35		

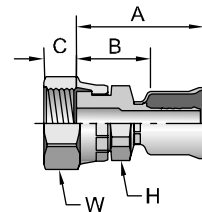

When measuring overall length to the end of the nut, B + C must be used to calculate cut-off allowance.
 See Accessories Section for O-Rings.



1J726

Female Seal-Lok® - Swivel - 45° Elbow

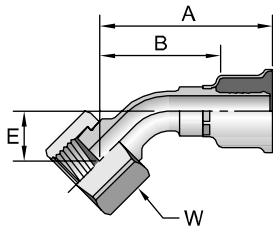

# Part Number	Thread		Hose I.D. inch	A		E		W		B	
	inch	inch		inch	mm	inch	mm	inch	mm	inch	mm
1J726-4-4	1/4	9/16x18	3/16	1.99	51	0.39	10	11/16	1.12	28	
1J726-6-6	3/8	11/16x16	5/16	2.43	62	0.43	11	13/16	1.57	40	
1J726-8-8	1/2	13/16x16	13/32	2.77	70	0.59	15	15/16	1.91	49	
1J726-10-10	5/8	1x14	1/2	3.26	83	0.63	16	1-1/8	2.31	59	
1J726-12-12	3/4	1-3/16x12	5/8	3.13	80	0.83	21	1-3/8	2.19	56	
1J726-16-16	1	1-7/16x12	7/8	3.61	92	0.94	24	1-5/8	2.57	65	
1J726-20-20	1-1/4	1-11/16x12	1-1/8	3.93	100	1.00	25	1-7/8	2.87	73	

1J926

Female Seal-Lok® - Swivel - 90° Elbow - Short Drop

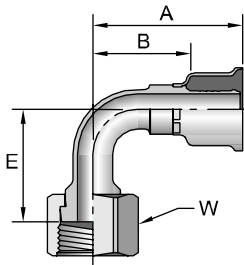

# Part Number	Thread		Hose I.D. inch	A		E		W		B	
	inch	inch		inch	mm	inch	mm	inch	mm	inch	mm
1J926-4-4	1/4	9/16x18	3/16	1.80	46	0.83	21	11/16	0.93	24	
1J926-6-6	3/8	11/16x16	5/16	1.86	47	0.91	23	13/16	1.00	25	
1J926-8-8	1/2	13/16x16	13/32	2.14	54	1.14	29	15/16	1.28	33	
1J926-10-10	5/8	1x14	1/2	2.53	64	1.26	32	1-1/8	1.58	40	
1J926-12-12	3/4	1-3/16x12	5/8	2.51	64	1.89	48	1-3/8	1.57	40	
1J926-16-16	1	1-7/16x12	7/8	3.56	90	2.21	56	1-5/8	2.52	64	
1J926-20-20	1-1/4	1-11/16x12	1-1/8	4.05	103	2.51	64	1-7/8	2.99	76	

1S526

Male Tube-O - Swivel - Short Pilot

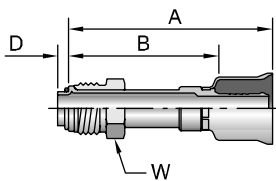

# Part Number	Thread		Hose I.D. inch	A		D		W		B	
	inch	inch		inch	mm	inch	mm	inch	mm	inch	mm
1S526-6-6	3/8	5/8x18	5/16	2.54	65	0.18	4,7	5/8	1.68	43	
1S526-7-6	11/16	11/16x16	5/16	2.57	65	0.18	4,7	5/8	1.71	43	
1S526-8-8	1/2	3/4x18	13/32	2.68	68	0.18	4,7	3/4	1.82	46	
1S526-10-10	5/8	7/8x18	1/2	3.46	88	0.18	4,7	7/8	2.51	64	
1S526-10-12	5/8	7/8x18	5/8	3.63	92	0.18	4,7	7/8	2.69	68	
1S526-12-12	3/4	1-1/16x16	5/8	4.00	102	0.18	4,7	1-1/16	3.06	78	

When measuring overall length to the end of the nut, B+D must be used to calculate cut-off allowance.

See Accessories Section for O-Rings.

1S526-PR

Male Tube-O - Swivel - Short Pilot
with Charge Port for R12

# Part Number	Thread		Hose I.D. inch	A		D		G		W inch	B	
	inch	7/8x18		inch	mm	inch	mm	inch	mm		inch	mm
1S526-10-10-PR	5/8	7/8x18	1/2	3.52	89	0.18	4,7	0.47	12	7/8	2.57	65
1S526-10-12-PR	5/8	7/8x18	5/8	3.68	93	0.18	4,7	0.47	12	7/8	2.74	70

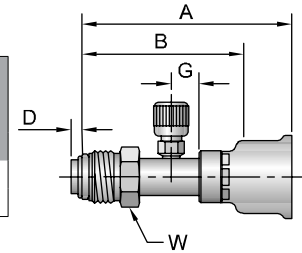

15R26

Male Tube-O - Swivel - 45° Elbow - Short Pilot

# Part Number	Thread		Hose I.D. inch	A		D		E		W inch	B	
	inch	5/8x18		inch	mm	inch	mm	inch	mm		inch	mm
15R26-6-6	3/8	5/8x18	5/16	2.52	64	0.18	4,7	0.85	22	5/8	1.66	42
15R26-8-8	1/2	3/4x18	13/32	2.53	64	0.18	4,7	1.05	27	3/4	1.67	42
15R26-10-10	5/8	7/8x18	1/2	2.99	76	0.18	4,7	1.25	32	7/8	2.04	52
15R26-10-12	5/8	7/8x18	5/8	3.16	80	0.18	4,7	1.25	32	7/8	2.22	56

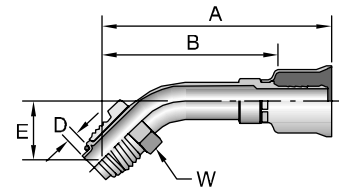

15K26

Male Tube-O - Swivel - 90° Elbow - Short Pilot

# Part Number	Thread		Hose I.D. inch	A		D		E		W inch	B	
	inch	5/8x18		inch	mm	inch	mm	inch	mm		inch	mm
15K26-6-6	3/8	5/8x18	5/16	2.06	52	0.18	4,7	1.76	45	5/8	1.19	30
15K26-7-6	7/16	11/16x16	5/16	2.21	56	0.18	4,7	1.76	44	11/16	1.35	34
15K26-8-8	1/2	3/4x18	13/32	2.06	52	0.18	4,7	1.74	44	3/4	1.20	30
15K26-10-10	5/8	7/8x18	1/2	2.34	59	0.18	4,7	2.20	56	7/8	1.39	35
15K26-10-12	5/8	7/8x18	5/8	2.51	64	0.18	4,7	2.20	56	7/8	1.57	40

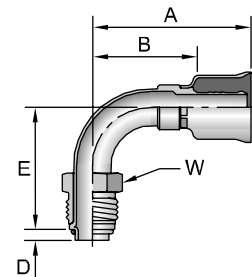

15K26-PB

Male Tube-O - Swivel - 90° Elbow - Short Pilot
with High Pressure Charge Port for R134a

# Part Number	Thread		Hose I.D. inch	A		D		E		G		W inch	B	
	inch	3/4x18 <th>inch</th> <th>mm</th> <th>inch</th> <th>mm</th> <th>inch</th> <th>mm</th> <th>inch</th> <th>mm</th> <th>inch</th> <th>mm</th>		inch	mm	inch	mm	inch	mm	inch	mm		inch	mm
15K26-8-8-PB	1/2	3/4x18	13/32	2.70	69	0.18	4,6	1.74	44	0.60	15	3/4	1.88	48

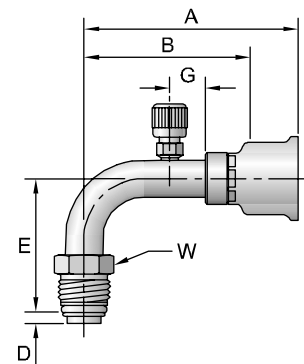

15K26-PR

Male Tube-O - Swivel - 90° Elbow - Short Pilot
with Charge Port for R12

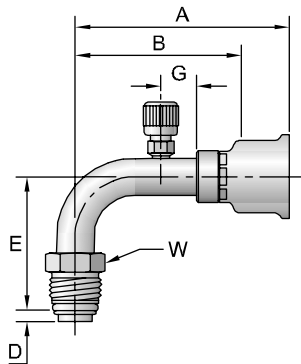

# Part Number	Thread		Hose I.D. inch	A		D		E		G		W	B	
	inch	mm		inch	mm	inch	mm	inch	mm	inch	mm		inch	mm
15K26-10-10-PR	5/8	7/8x18	1/2	3.14	80	0.18	4,7	2.25	57	0.60	15	7/8	2.19	56
15K26-10-12-PR	5/8	7/8x18	5/8	3.43	87	0.18	4,7	2.22	56	0.60	15	7/8	2.49	63

14526-PR

Male Tube-O - Swivel - Long Pilot With
Charge Port for R12

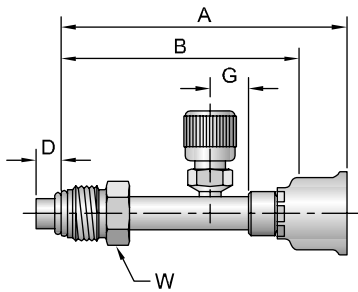

# Part Number	Thread		Hose I.D. inch	A		D		G		W	B	
	inch	mm		inch	mm	inch	mm	inch	mm		inch	mm
14526-6-6-PR	3/8	5/8x18	5/16	3.25	83	0.28	7,1	0.50	13	5/8	2.40	61

14526-PT

Male Tube-O - Swivel - Long Pilot With
With Low Pressure Charge Port for R134a

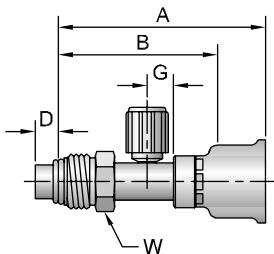

# Part Number	Thread		Hose I.D. inch	A		D		G		W	B	
	inch	mm		inch	mm	inch	mm	inch	mm		inch	mm
14526-10-12-PT	5/8	7/8x18	5/8	3.45	88	0.38	9,8	0.44	11	7/8	2.51	64

15M26-PR

Male Tube-O - Swivel - 90° Elbow - Long Pilot With
Charge Port for R12

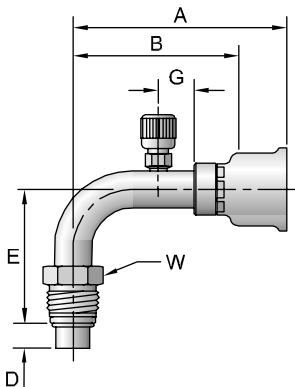

# Part Number	Thread		Hose I.D. inch	A		D		E		G		W	B	
	inch	mm		inch	mm	inch	mm	inch	mm	inch	mm		inch	mm
15M26-6-6-PR	3/8	5/8x18	5/16	2.48	63	0.28	7,1	1.58	40	0.50	13	5/8	1.62	41

15M26-PT

Male Tube-O - Swivel - 90° Elbow - Long Pilot With
With Low Pressure Charge Port for R134a

# Part Number	Thread		Hose I.D.		A		D		E		G		W		B	
	inch	mm	inch	mm	inch	mm	inch	mm	inch	mm	inch	mm	inch	mm	inch	mm
15M26-10-12-PT	5/8	7/8x18	5/8	3.25	83	0.38	9,8	2.25	57	0.60	15	7/8	2.31	59		

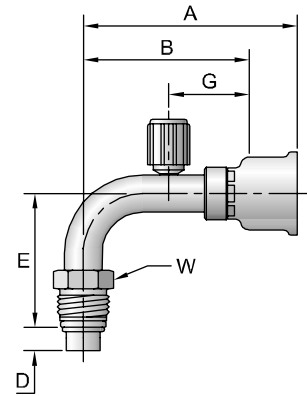

15G26

Male Tube-O - Rigid - Internal Long Pilot (3-Step)

# Part Number	Thread		Hose I.D.		A		H		B	
	inch	mm	inch	mm	inch	mm	inch	mm	inch	mm
15G26-6-6	3/8	5/8x18	3/8	1.78	45	0.625	0.92	23		
15G26-8-8	1/2	3/4x16	13/32	1.95	50	3/4	1.09	28		
15G26-10-10	5/8	7/8x14	1/2	4.05	103	7/8	3.10	79		
15G26-10-12	5/8	7/8x14	5/8	2.19	56	0.875	1.25	32		

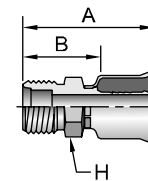

15G26-PR

Male Tube-O - Rigid - Internal Long Pilot (3-Step)
With Charge Port for R12

# Part Number	Thread		Hose I.D.		A		G		W		B	
	inch	mm	inch	mm	inch	mm	inch	mm	inch	mm	inch	mm
15G26-10-12-PR	5/8	7/8x14	5/8	4.27	108	0.60	15	7/8	3.33	85		

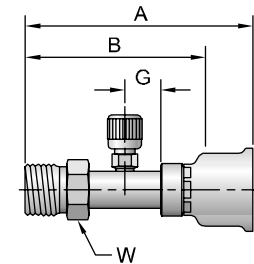

15S26

Female Tube-O - Swivel - Short Pilot

# Part Number	Thread		Hose I.D.		A		D		W		B	
	inch	mm	inch	mm	inch	mm	inch	mm	inch	mm	inch	mm
15S26-6-6	3/8	5/8x18	5/16	2.54	65	0.18	4,7	3/4	1.68	43		
15S26-8-8	1/2	3/4x16	13/32	2.68	68	0.18	4,7	7/8	1.82	46		
15S26-10-10	5/8	7/8x14	1/2	2.84	72	0.18	4,7	1-1/16	1.89	48		
15S26-10-12	5/8	7/8x14	5/8	3.63	92	0.18	4,7	1-1/16	2.69	68		
15S26-12-12	3/4	1-1/16x14	5/8	4.00	102	0.18	4,7	1-1/4	3.06	78		

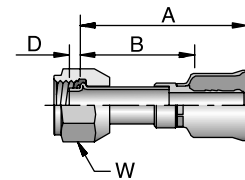

15H26

Female Tube-O - Swivel 45° Elbow - Short Pilot

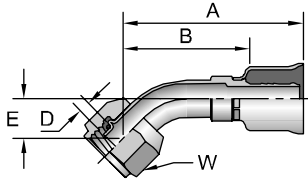

# Part Number	Thread inch	Hose I.D. inch	A		D		E		W		B	
			inch	mm	inch	mm	inch	mm	inch	inch	mm	mm
15H26-6-6	3/8 5/8x18	5/16	2.35	60	0.18	4,7	0.54	14	3/4	1.49	38	
15H26-8-8	1/2 3/4x16	13/32	2.48	63	0.18	4,7	0.60	15	7/8	1.62	41	
15H26-10-10	5/8 7/8x14	1/2	3.23	82	0.18	4,7	0.67	17	1 1/16	2.28	58	
15H26-10-12	5/8 7/8x14	3/4	3.43	87	0.18	4,7	0.67	17	1-1/16	2.46	62	

15T26

Female Tube-O - Swivel - 90° Elbow - Short Pilot

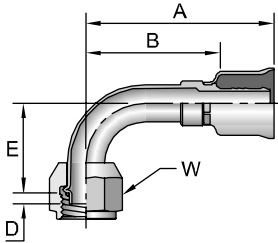

# Part Number	Thread inch	Hose I.D. inch	A		D		E		W		B	
			inch	mm	inch	mm	inch	mm	inch	inch	mm	mm
15T26-6-6	3/8 5/8x18	5/16	1.89	48	0.18	4,7	1.15	29	3/4	1.03	26	
15T26-8-8	1/2 3/4x16	13/32	2.34	59	0.18	4,7	1.46	37	7/8	1.48	38	
15T26-10-10	5/8 7/8x14	1/2	2.08	53	0.18	4,7	1.75	44	1-1/16	1.08	27	
15T26-10-12	5/8 7/8x14	5/8	2.20	56	0.18	4,7	1.53	39	1-1/16	1.26	32	
15T26-12-12	3/4 1-1/16x14	5/8	2.63	67	0.18	4,7	1.75	44	1-1/4	1.69	43	

15926-PB

Female Tube-O - Swivel - Long Pilot
With High Pressure Charge Port for R134a

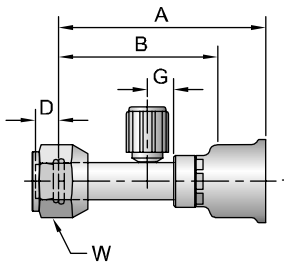

# Part Number	Thread inch	Hose I.D. inch	A		D		G		W		B	
			inch	mm	inch	mm	inch	mm	inch	inch	mm	mm
15926-6-6-PB	3/8 5/8x18	5/16	3.25	83	0.28	7,1	0.75	19	3/4	2.39	61	
15926-8-8-PB	1/2 3/4x16	13/32	2.74	70	0.38	9,8	0.50	13	7/8	1.88	48	

15926-PT

Female Tube-O - Swivel - Long Pilot
With Low Pressure Charge Port for R134a

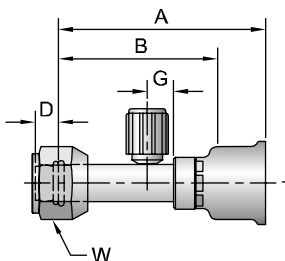

# Part Number	Thread inch	Hose I.D. inch	A		D		G		W		B	
			inch	mm	inch	mm	inch	mm	inch	inch	mm	mm
15926-10-12-PT	5/8 7/8x14	5/8	3.47	88	0.38	9,8	0.60	15	1-1/16	2.53	64	

15N26-PB

Female Tube-O - Swivel - 45° Elbow - Long Pilot
With High Pressure Charge Port for R134a

# Part Number	Thread		Hose I.D. inch	A		D		E		G		W		B	
	inch			inch	mm	inch	mm	inch	mm	inch	mm	inch	mm	inch	mm
15N26-8-8-PB	1/2	3/4x16	13/32	3.67	93	0.38	9,8	0.90	23	0.60	15	7/8	2.81	72	

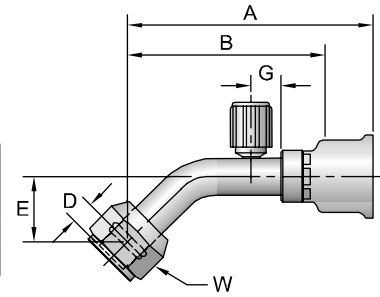

15N26-PT

Female Tube-O - Swivel - 45° Elbow - Long Pilot
With Low Pressure Charge Port for R134a

# Part Number	Thread		Hose I.D. inch	A		D		E		G		W		B	
	inch			inch	mm	inch	mm	inch	mm	inch	mm	inch	mm	inch	mm
15N26-10-12-PT	5/8	7/8x14	5/8	3.92	100	0.38	9,8	1.21	31	0.60	15	1-1/16	2.98	76	

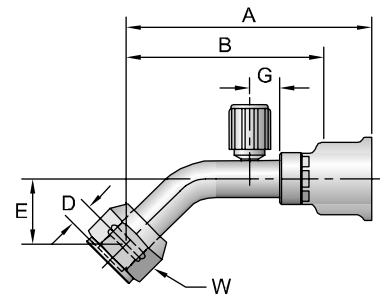

15L26

Female Tube-O - Swivel - 90° Elbow - Long Pilot

# Part Number	Thread		Hose I.D. inch	A		D		E		W		B	
	inch			inch	mm	inch	mm	inch	mm	inch	mm	inch	mm
15L26-8-8	1/2	3/4x14	13/32	2.14	54	0.38	9,8	1.46	37	7/8	1.28	33	

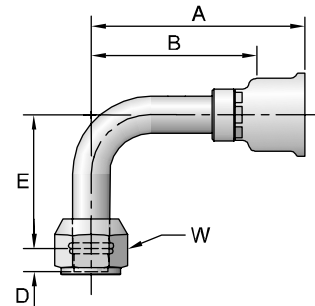

15L26-PB

Female Tube-O - Swivel - 90° Elbow - Long Pilot
With High Pressure Charge Port for R134a

# Part Number	Thread		Hose I.D. inch	A		D		E		G		W		B	
	inch			inch	mm	inch	mm	inch	mm	inch	mm	inch	mm	inch	mm
15L26-6-6-PB	3/8	5/8x18	5/16	2.50	64	0.28	7,1	1.22	31	0.50	13	3/4	1.64	42	
15L26-8-8-PB	1/2	3/4x16	13/32	2.80	71	0.38	9,8	1.46	37	0.60	15	7/8	1.94	49	
15L26-10-12-PB	5/8	7/8x14	5/8	2.80	71	0.38	9,8	1.46	37	0.60	15	1-1/16	1.94	49	

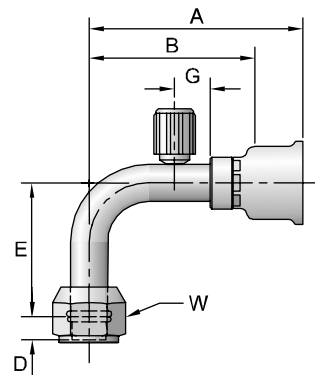

15L26-PR

Female Tube-O - Swivel - 90° Elbow - Long Pilot
With Charge Port for R12

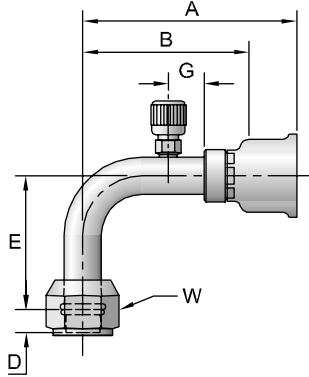

# Part Number	Thread inch	Hose I.D. inch	A		D		E		G		W		B	
			inch	mm	inch	mm	inch	mm	inch	mm	inch	mm	inch	mm
15L26-8-8-PR	1/2 3/4x16	13/32	2.79	71	0.38	9,8	1.46	37	0.60	15	7/8	1.93	49	
15L26-10-10-PR	5/8 7/8x14	1/2	3.59	91	0.38	9,8	2.25	57	0.60	15	1-1/16	2.64	67	
15L26-10-12-PR	5/8 7/8x14	5/8	3.25	83	0.38	9,8	2.25	57	0.60	15	1-1/16	2.31	59	

15L26-PT

Female Tube-O - Swivel - 90° Elbow - Long Pilot
With Low Pressure Charge Port for R134a

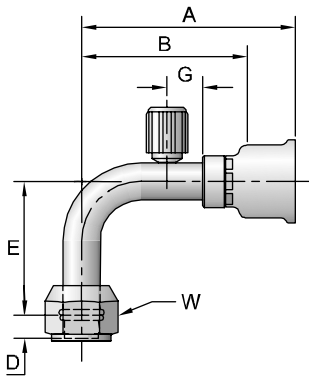

# Part Number	Thread inch	Hose I.D. inch	A		D		E		G		W		B	
			inch	mm	inch	mm	inch	mm	inch	mm	inch	mm	inch	mm
15L26-10-10-PT	5/8 7/8x14	1/2	2.95	75	0.38	9,8	2.25	57	0.60	15	1-1/16	2.00	51	
15L26-10-12-PT	5/8 7/8x14	5/8	3.25	83	0.38	9,8	2.25	57	0.60	15	1-1/16	2.31	59	
15L26-12-12-PT	3/4 1-1/16x14	5/8	3.58	91	0.38	9,8	2.66	68	0.60	15	1-1/4	2.64	67	

15P26-PT

Male Tube-O - Swivel - 45° Elbow - Long Pilot With
With Low Pressure Charge Port for R134a

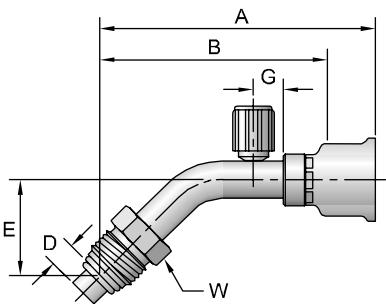

# Part Number	Thread inch	Hose I.D. inch	A		D		E		G		W		B	
			inch	mm	inch	mm	inch	mm	inch	mm	inch	mm	inch	mm
15P26-10-12-PT	5/8 7/8x18	5/8	3.81	97	0.38	9,8	1.21	31	0.60	15	7/8	2.87	73	

17B26

Female Air Brake Jounce Line - Swivel

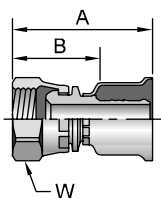

# Part Number	Thread inch	Hose inch	A		W		B	
			inch	mm	inch	mm	inch	mm
17B26-8-6BA	1/2 3/4x20	5/16	1.75	44	11/16	0.89	23	
17B26-8-8BA	1/2 3/4x20	13/32	1.75	44	11/16	0.89	23	

15V26

Female Compressor - Swivel - 45° Elbow

# Part Number	Thread inch	Hose I.D. inch	A		E		W inch	B	
			inch	mm	inch	mm		inch	mm
15V26-12-8	1x14	13/32	2.72	69	0.75	19	1-1/8	1.86	47
15V26-12-12	1x14	5/8	3.39	86	0.76	19	1-1/8	2.45	62

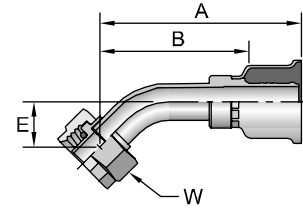

15W26

Female Compressor - Swivel - 90° Elbow

# Part Number	Thread inch	Hose I.D. inch	A		E		W inch	B	
			inch	mm	inch	mm		inch	mm
15W26-12-8	1x14	13/32	2.24	57	1.25	32	1.125	1.38	35
15W26-12-12	1x14	5/8	3.04	77	1.63	41	1.125	2.10	53

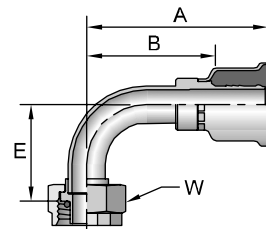

15Z26

Female Compressor - Swivel - 90° Elbow - Block Type

# Part Number	Thread inch	Hose I.D. inch	A		E		W inch	B	
			inch	mm	inch	mm		inch	mm
15Z26-12-8	1X14	0.40625	1.79	45	0.80	20	1.125	0.93	24
15Z26-12-12	1X14	0.625	1.87	47	0.80	20	1.125	0.93	24

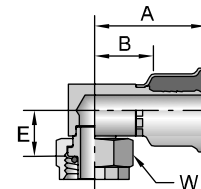

1RV26

Female Compressor - Swivel - 135° Elbow

# Part Number	Hose I.D. inch	inch	A		E		W inch	B	
			inch	mm	inch	mm		inch	mm
1RV26-12-8	13/32	3.24	82	3.21	82	1-1/8	2.38	60	
1RV26-12-12	5/8	2.32	59	3.21	82	1-1/8	1.38	35	

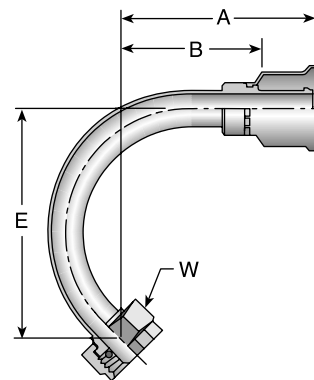

A

B

C

D

E

1RZ26

Female Compressor - Swivel - 180° Elbow - Block Type RZ

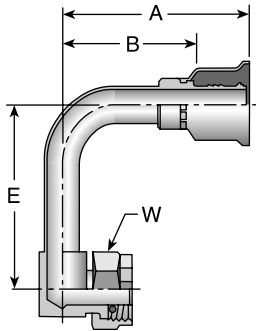

# Part Number	Thread inch	Hose I.D. inch	A		E		W		B	
			inch	mm	inch	mm	inch	inch	mm	
1RZ26-12-12	1x14	5/8	2.98	76	3.13	80	1-1/8	2.04	52	

1T126

Male Refrigerant Tube Mender
(with Nut and Ferrule)

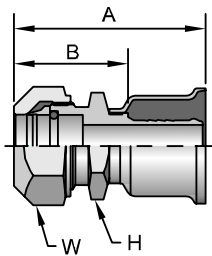

# Part Number	Thread inch		Hose I.D. inch	A		H inch	B	
	inch	mm		inch	mm		inch	mm
1T126-6-6	3/8	5/8x18	5/16	1.96	50	11/16	1.10	28
1T126-8-8	1/2	3/4x16	13/32	2.07	53	13/16	1.21	31
1T126-10-10	5/8	7/8x14	1/2	2.28	58	15/16	1.33	34
1T126-10-12	5/8	7/8x14	5/8	2.27	58	15/16	1.33	34
1T126-12-12	3/4	1-16x14	5/8	2.33	59	1-1/8	1.39	35

1T126 Assembly instructions on page B-25.

1T126

Fitting Installation Instructions

1. Cut the tube off squarely next to the hose fitting. At least 7/8" straight length is required and the outside diameter of the tube should be smooth and free from deep lengthwise scratches.
2. To prevent cutting the inside of the O-Ring, smoothly chamfer the outside diameter of the cut end 15° to 30°. Deburr the inside diameter.
3. Remove the nut, compression sleeve, and O-Ring from the fitting and lubricate the O-Ring with a lubricant that is compatible with the refrigerant used in the system.
4. Place the lubricated O-Ring in the counterbore of the fitting.
5. Slip the compression sleeve, small end, into the nut and assemble the nut on the fitting fingertight. Make sure the compression sleeve is not cocked in the nut. Back the nut off 1/6 to 1/3 turn (one to two hex flats).
6. Insert the chamfered tube end through the nut into the fitting. If high resistance is felt when the end of the tube contacts the O-Ring, remove the tube. The end of the tube may require a large chamfer and/or the O-Ring may require more lubrication on the inside diameter. Repeat the previous steps.
7. (a) Make sure the tube is bottomed in the fitting
(b) Tighten the nut finger tight
(c) Mark the fitting and nut hex indicating the starting point (see illustration) and
(d) Wrench tighten the nut 1 to 1-1/6 turns (6 to 7 hex flats).
8. Later, if it is ever necessary to loosen the connection, re-assemble the nut 1/6 turn (one hex flat) after finger tight.

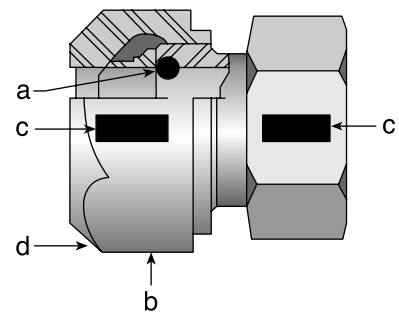

IF YOU HAVE QUESTIONS CONCERNING THE PRODUCTS
OR APPLICATION OF THE PRODUCTS CONTAINED IN THIS
CATALOG, PLEASE CALL:
PARKER HOSE PRODUCTS DIVISION
TECHNICAL SERVICES DEPARTMENT
PHONE: 440 / 943-5700
FAX: 440 / 943-3129
<http://www.parkerhose.com>

A

B

C

D

E