



aerospace
climate control
electromechanical
filtration
fluid & gas handling
hydraulics
pneumatics
process control
sealing & shielding



Series 2002 & P120 Rodless Pneumatic Cylinders

Catalog 0953



ENGINEERING YOUR SUCCESS.

www.comoso.com 800.696.6165

Warning, Offer of Sale

 **WARNING**

FAILURE OR IMPROPER SELECTION OR IMPROPER USE OF THE PRODUCTS AND/OR SYSTEMS DESCRIBED HEREIN OR RELATED ITEMS CAN CAUSE DEATH, PERSONAL INJURY AND PROPERTY DAMAGE.

This document and other information from Parker Hannifin Corporation, its subsidiaries and authorized distributors provide product and/or system options for further investigation by users having technical expertise. It is important that you analyze all aspects of your application including consequences of any failure, and review the information concerning the product or system in the current product catalog. Due to the variety of operating conditions and applications for these products or systems, the user, through its own analysis and testing, is solely responsible for making the final selection of the products and systems and assuring that all performance, safety and warning requirements of the application are met.

The products described herein, including without limitation, product features, specifications, designs, availability and pricing, are subject to change by Parker Hannifin Corporation and its subsidiaries at any time without notice.

Offer of Sale

The items described in this document are hereby offered for sale by Parker Hannifin Corporation, its subsidiaries or its authorized distributors. This offer and its acceptance are governed by the provisions stated on the separate page of this document entitled "Offer of Sale".

© Copyright 2008 Parker Hannifin Corporation. All Rights Reserved



www.comoso.com 800.696.6165

Parker Hannifin Corporation
Parker-Origa
Glendale Heights, Illinois
www.parkeroriga.com

General Information	Page
- The Origa Principle	2
- Benefits	3
- Ordering Procedure	4
Application Data	
- Circuit Configurations.....	5
- Applications.....	6
Technical Data	
- Six Unique Advantages.....	7
- Product Range	8
- Technical Summary.....	9-10
- Loading Diagrams.....	11
Series 2002 Basic Design	
- Series 2002 Basic Cylinder.....	12
- Piston Mountings	13-14
- Dimensions	15-16
- Cylinder Mountings	17-18
Series 2002 Joint Clamp	
- Series 2002 Joint Clamp.....	19
- Piston Mountings	20
- Dimensions	21
- Cylinder Mountings	22
Series P120 Basic Design	
- Series P120	23
- Piston Mountings	24
- Dimensions	25
- Cylinder Mountings	26
Magnetic Switches.....	27-29
Spare Parts	
- Series 2002.....	30-33
- Series P120	34-39
Service Packs.....	40
Safety Guide.....	42-43
Offer of Sale	44

The ORIGA Principle

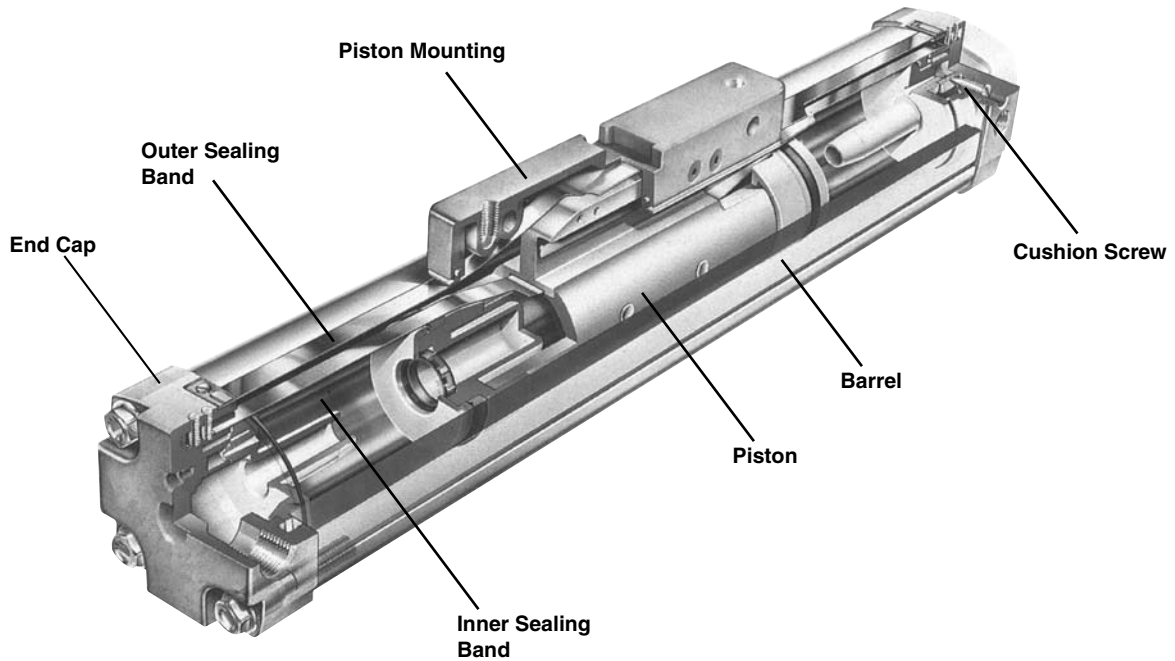

Features

1. The cylinder barrel of extruded anodized aluminum has a slot along its entire length. To provide rigidity the bore is eccentric to the outside diameter.
2. A flexible hardened stainless steel inner band running the entire length of the bore and passing through the piston provides a near-zero-leakage metal to metal seal. An outer band of the same material acts as a cover over the slot preventing foreign particles from entering into the cylinders interior.
3. The aluminum piston is fitted with synthetic bearing rings. The power transmission outward takes place through a positive, physical connection through the slot to the external piston mounting. This solid guide permits the acceptance of external forces and moments and minimizes frictional losses.
4. The extensive experience in the development and production of rodless cylinders, as well as the use of high quality components and materials, ensure a very serviceable design lending itself to high operating safety and optimum performance.
5. This unique design, using only 4 main components, makes ORIGA cylinders reliable in operation and simple to maintain, providing long trouble free service.
6. ORIGA is the specialist in the rodless cylinder field. ORIGA has the largest range of bore diameters and can offer the longest stroke lengths with application oriented accessories for cost effective designs. ORIGA has experience in all conceivable areas of industry, attributable to the thousands of applications in which ORIGA rodless cylinders are used.

Technical Benefits

Design Options

Parker ORIGA cylinders can be supplied as a basic model, or as a basic model with external guides depending on the application requirements.

Cylinder Mountings

Various types of piston mounting are available including one which allows the cylinder to be inverted under adverse operating conditions thus protecting the sealing bands. End mounting brackets and midsection supports are also available.

Operating Pressure

Max. 120 P.S.I.

End Of Stroke Cushioning

Adjustable cushioning is provided as standard and ensures the piston stops smoothly, even at high speeds.

Oil Free Operation

The Parker ORIGA permanent lubricating grease eliminates the need for regular oil mist lubrication and provides long service life. Cylinders can be used in applications where maximum cleanliness is required. (e.g. electronics pharmaceutical and food processing industries).

Slow Speed Applications

The construction of the Parker ORIGA rodless cylinder allows for a low friction characteristic permitting extremely slow traversing speeds. For speeds below 4 inches / second we recommend that Parker ORIGA "slow speed" lubrication is specified.

Temperature Range/Piston Speed

Standard Buna-N seals are suitable for temperatures from 15°F to +175°F. Viton seals are required for higher temperatures as well as for use when piston speeds exceed 5 ft./sec. Please contact the Parker ORIGA Technical Department if the required operating temperature is above 175°F.

Magnetic Pistons

All Series 2002 cylinders are supplied as standard with magnetic pistons for proximity switch actuation.

Proximity Switches

Magnetically operated Hall Effect switches (IS) or Reed switches (RS) are available to sense piston position at any point over the entire stroke length.

Corrosive Environments

All screws are plated. In extreme applications stainless steel can be supplied. Special aluminum coatings are available for added protection against chemical or caustic wash down of equipment or in environments where corrosive gases are present.

Cylinder Loading

Values are based on shock-free duty and should not be exceeded during piston acceleration.

Note:

Seal life can be significantly influenced by extremes of speed, load and temperature which exceed the approved limits. Contact the Parker ORIGA Technical Department for assistance with special applications.

All specifications are subject to change without notice.

Ordering Procedure

Series 2002

Cylinder Bore Size: _____

16, 25, 32, 40 or 50

Configuration: _____

- = Single Cylinder
 J = Joint Clamp Unit
 C=Clean Room Cylinder

Piston Quantity: _____

20 = Single Piston
 22 = Double Piston

End Cap Cushion Placement: _____

20 = Standard Cushion Location (21 for 50mm)

30 = Cushion at Rear of Cap (31 for 50mm)

Note: Rear cushions are available on Ø25mm - Ø50mm only.

*Note: When entering total stroke length for 2220/2230 (double piston) cylinders be sure to first add the „CL“ distance to the actual, effective stroke length. Enter this total in the cylinder part number. Follow the same procedure for pricing.

32-2020/20X50-B-M

Prelube Specification (optional):

M = Standard
 C = Cleanroom
 F = Food Grade
 S = Slow Speed

Seal Type:

B = Buna
 V = Viton

***Stroke Length:**

Enter metric strokes followed by "mm" (i.e. 200mm)

Piston Mounting Type:

20 = Standard Mount
 25 = Floating Mount
 30 = Inverted Mount
 35 = Inverted Floating Mount
 For Joint Clamp Cylinders:
 24 = Platform Mount
 34 = Inverted Platform Mount

Series P120

Cylinder Series P120 _____

Cylinder Bore Size: _____

4 = 40mm
 6 = 63mm
 8 = 80mm

Piston/Mount Configuration: _____

Short Piston	Long Piston
S/20 = Standard Mount	L/26 = Standard Mount
S/22 = Platform Mount	L/28 = Platform Mount
S/25 = Floating Mount	L/36 = Inverted Mount
S/30 = Inverted Mount	L/38 = Inverted Platform Mount
S/32 = Inverted Platform Mount	
S/35 = Inverted Floating Mount	

P124-S/20X50-B-M

Prelube Specification (optional):

M = Standard
 C = Cleanroom
 F = Food Grade
 S = Slow Speed

Seal Type:

B = Buna
 V = Viton

Stroke Length:

Enter metric strokes followed by "mm" (i.e. 200mm)

Service Packs

Series 2002

SP32R-B-1 X S

Service Pack _____

Bore Size = 25, 32, _____

40, 50

B = Buna-N, V = Viton _____

1 = Single Piston _____

2 = Double Piston _____

Enter Stroke Length _____

Series P120

SP124-B-S X S

Service Pack _____

Bore Size: 124 = 40mm, _____

126 = 63mm, 128 = 80mm

B = Buna-N, V = Viton _____

S = Short Piston _____

L = Long Piston _____

Enter Stroke Length _____

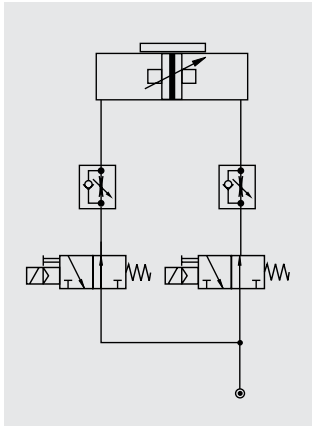

Circuit diagram for end of stroke application. Intermediate positioning is also possible.

The cylinder is controlled by two 3/2-way valves (normally open). The speed can be adjusted independently for both directions.

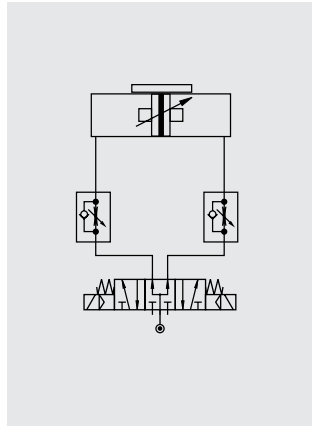

Circuit diagram for end of stroke application. Intermediate positioning is also possible.

The cylinder is controlled by a 5/3-way valve (middle position pressurized). The speed can be adjusted independently for both directions.

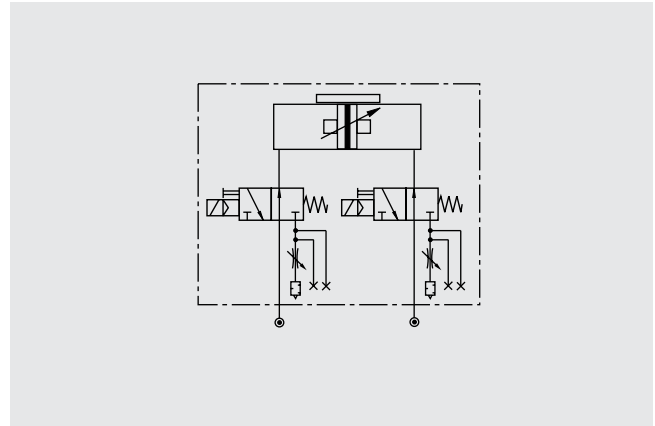

The optional integrated VOE Valves offer optimal control, and allow accurate

positioning of intermediate positions and the lowest possible speeds.

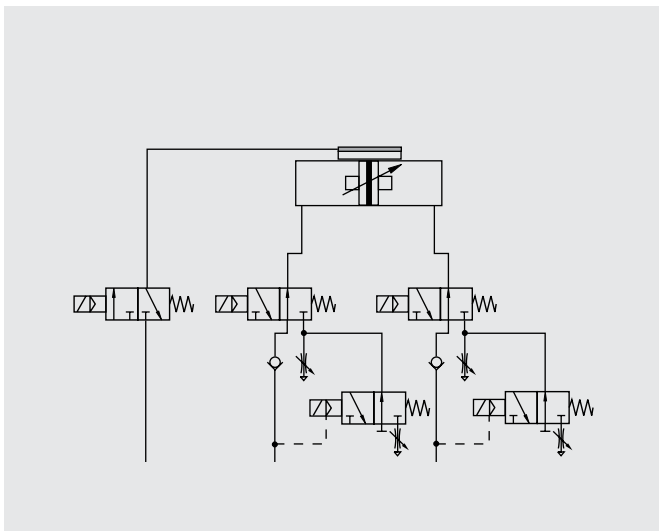

Fast/Slow speed cycle control with pneumatic brake for accurate positioning at high velocities. Additional 3/2-way valves with adjustable throttle valves at the exhaust of the standard directional control valves for two displacement

speeds in each direction of the piston's travel. The valve controlling the brake is activated after the slow speed cycle is activated

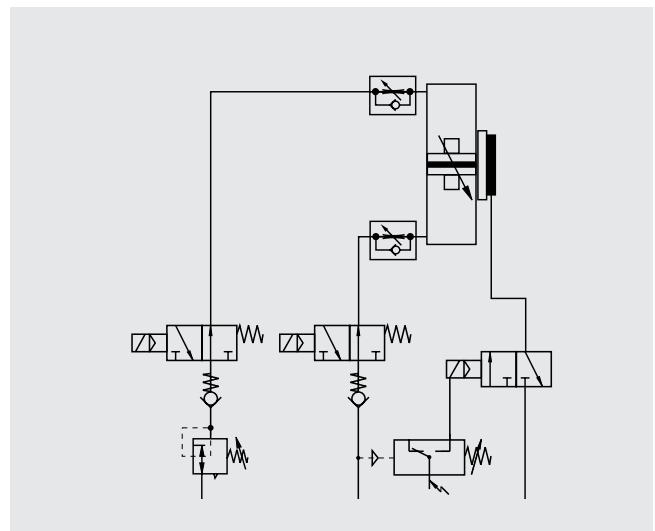

The combination of an OSP-cylinder with the passive MULTIBRAKE as shown here, allows accurate positioning and safety in case of loss of pneumatic air pressure.

Applications

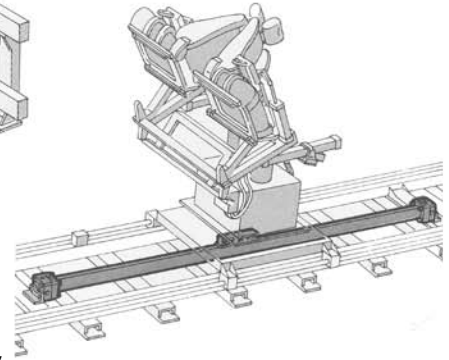
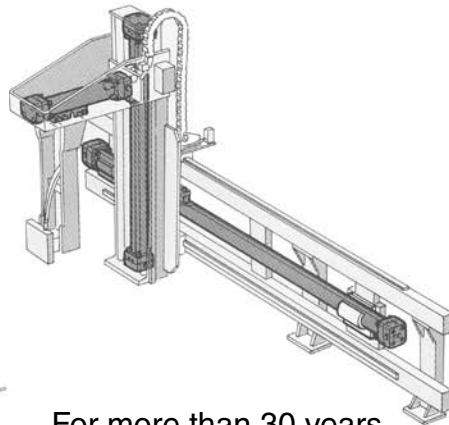
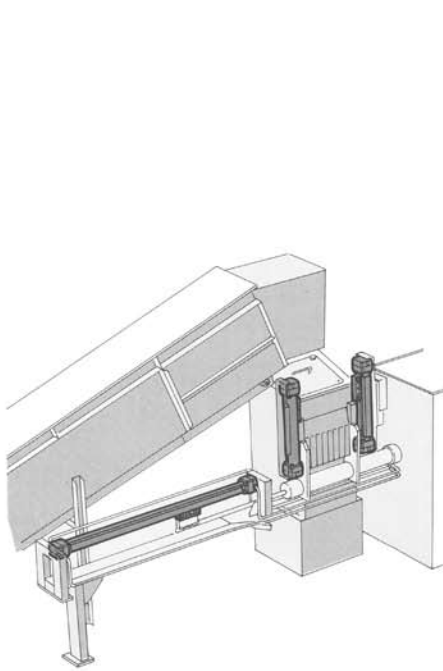

For more than 30 years Parker-Origa cylinders have provided solutions to linear motion problems in all types of industry.

Offering simple designs, easy installation, clean operation and maintenance free duty, Parker-Origa cylinders are suitable for a diversity of applications and environments.

For more information or assistance with your linear motion tasks, please call an authorized distributor or Parker-Origa direct.

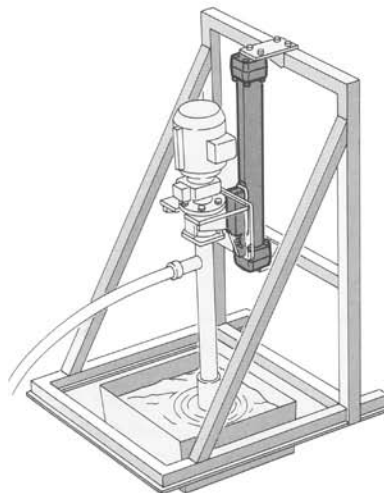
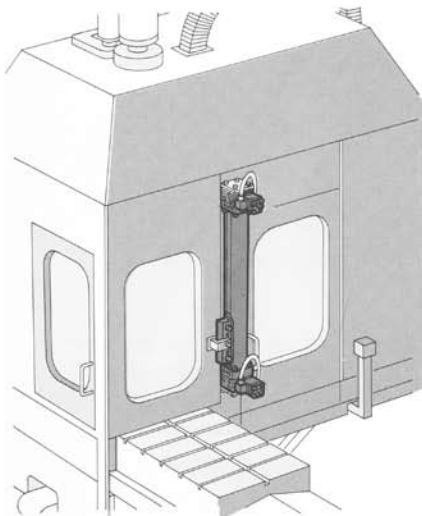
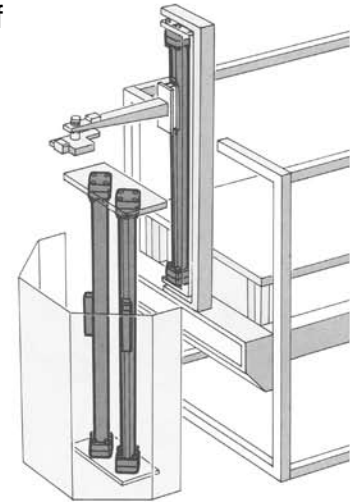

Six Unique Advantages

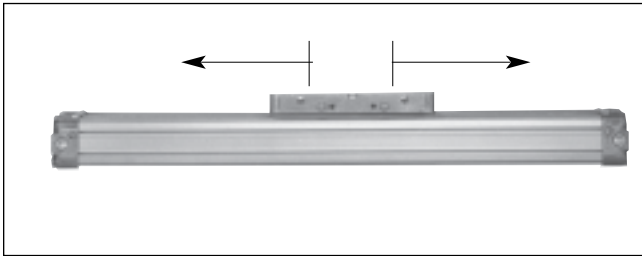

Equal Force and Speed

Equal piston area on each side of the piston allows for equal force and speed in both directions of travel. Additionally, the ability to “pneumatically lock” the piston at various points along the stroke is possible through the use of special valve configurations.

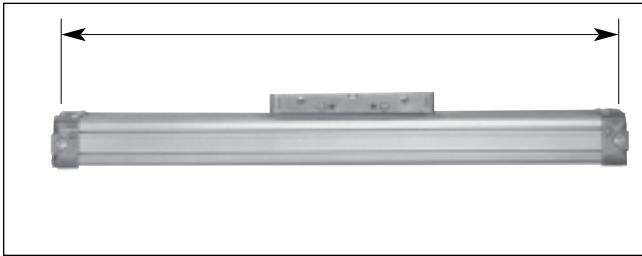

Any Length of Stroke

Infinitely variable strokes are available up to 480 inches and each cylinder is custom manufactured to customer requirements without incurring extended delivery times.

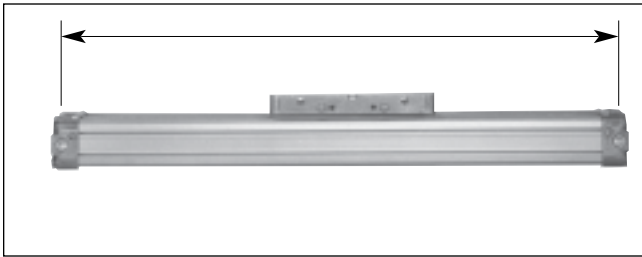

Space Saving

The lack of a piston rod allows for nearly half the space requirement of a “rod type” pneumatic cylinder. The result is a simpler, less costly installation reducing the amount of hardware and design time.

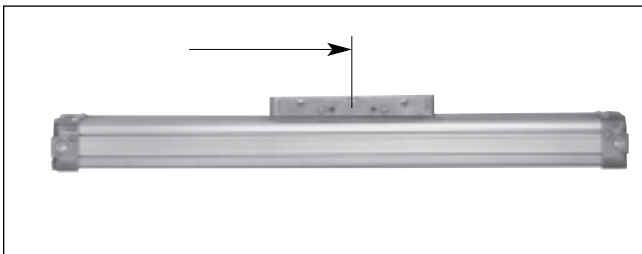

Accepts Cantilever Loads

The unique piston design and barrel rigidity allows the Origa cylinder to accept high direct and bending moment loads without the need for additional support hardware.

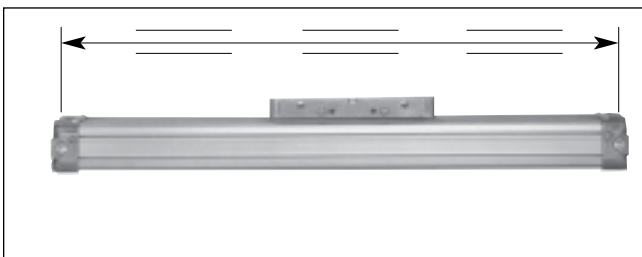

Self Guiding

The internal self-supporting characteristics of the Origa rodless cylinder provides guidance of the piston throughout the stroke. High priced guidance mechanisms (roundway bearings, precision slideways, etc.) are not required.

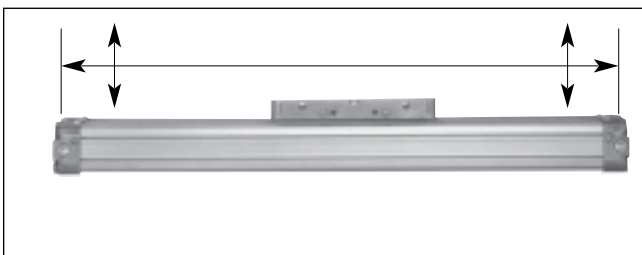

Inherent Rigidity

Integral strength and rigidity of the complete cylinder assembly will accommodate the heaviest of loads enabling the cylinder to form part of a structure or framework. This eliminates the need for expensive and bulky I-beams, channels and fabrications.

Product Range**The Product Range****Series 2002 - Basic Cylinder****Bore sizes (mm): 16, 25, 32, 40, 50**

The basic cylinder series satisfies the support and guidance requirements of a great diversity of applications. Various mounting and control options are available for specific application needs.

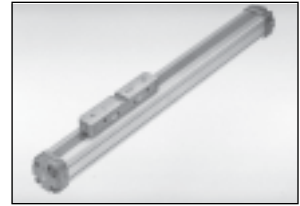
**Series 2002 - Joint Clamp****Bore sizes (mm): 25, 32, 40, 50**

Two cylinders mounted in a tandem configuration for increased load and force requirements. The arrangement enhances lateral support and bending moment capabilities.

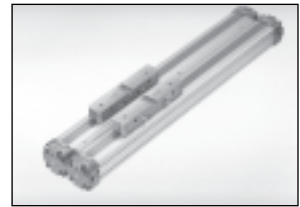
**Series P120 - Basic Cylinder****Bore sizes (mm): 40, 63, 80**

For high force and load requirements, the P120 series provides optimal strength and a unique package of options.



Technical Summary

2020/20

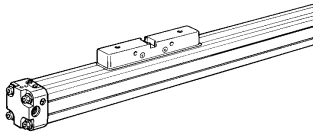

2020/25

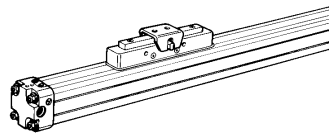

2020/30

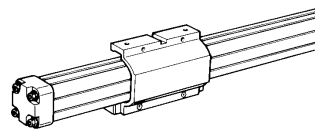

2020/35

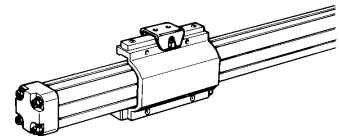

2220/20

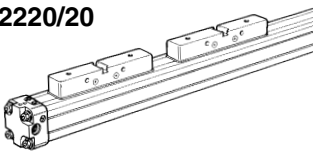

2220/30

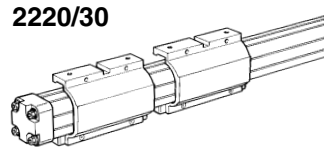

J2020/24

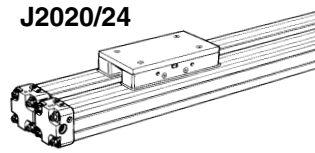

J2020/34

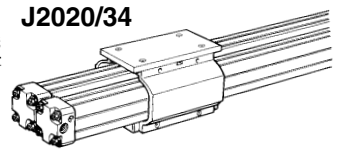

Series	Cyl. Ø (mm)	Theoretical Force at 87 PSI (lbs. force)	Cushion Length (in.)	Max. Allowed Bending Moment Mx (in./lbs.)	Max. Allowed Bending Moment Mz (in./lbs.)	Max. Allowed Bending Moment My (in./lbs.)	Max. Allowed Load L (lbs.)
Series 2002 Single Piston	16	27	0.59	35	3	5	30
	25	66	0.55	132	9	27	65
	32	108	1.10	318	36	120	115
	40	169	1.42	575	53	156	195
	50	265	1.50	1017	98	312	270
Series 2002 Double Piston	16	27	0.59	81	6	9	60
	25	66	0.55	336	18	45	130
	32	108	1.10	720	72	600	230
	40	169	1.42	1320	106	792	390
	50	265	1.50	2304	196	1464	540
Joint Clamp Single Piston	25	132	0.55	264	115	54	130
	32	216	1.10	636	248	240	230
	40	338	1.42	1150	444	312	390
	50	530	1.50	2034	859	624	540
Joint Clamp Double Piston	25	132	0.55	672	230	90	260
	32	216	1.10	1440	496	1200	460
	40	338	1.42	2640	888	1584	780
	50	530	1.50	4608	1718	2928	1080
Series P120 Short Piston	40	169	1.26	528	36	72	170
	63	420	1.57	1776	72	216	370
	80	677	1.73	3192	144	420	590
Series P120 Long Piston	40	169	1.26	1200	72	216	170
	63	420	1.57	3984	144	660	370
	80	677	1.73	6372	288	1236	590

Technical Summary

P120-S/20

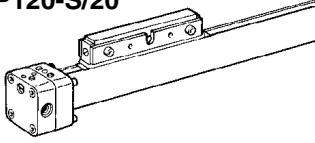

P120-S/22

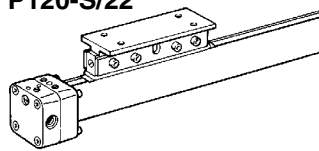

P120-S/25

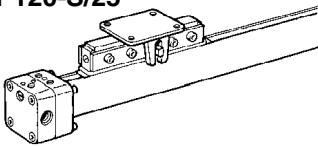

P120-S/30

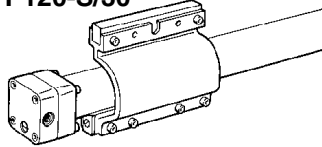

P120-S/32

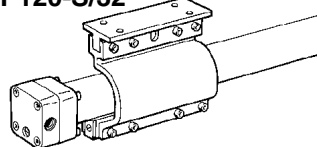

P120-S/35

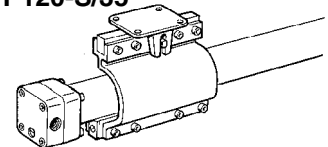

P120-L/26

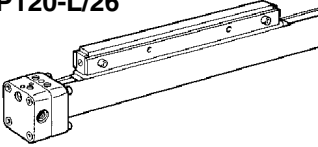

P120-L/28

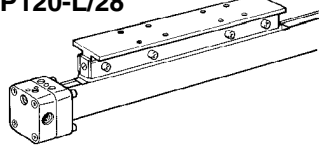

P120-L/36

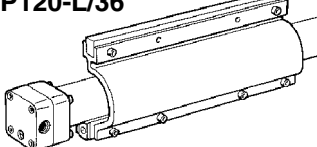

P120-L/38

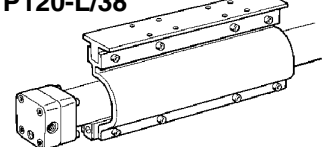

**Cushion Diagram
 Series 2002**

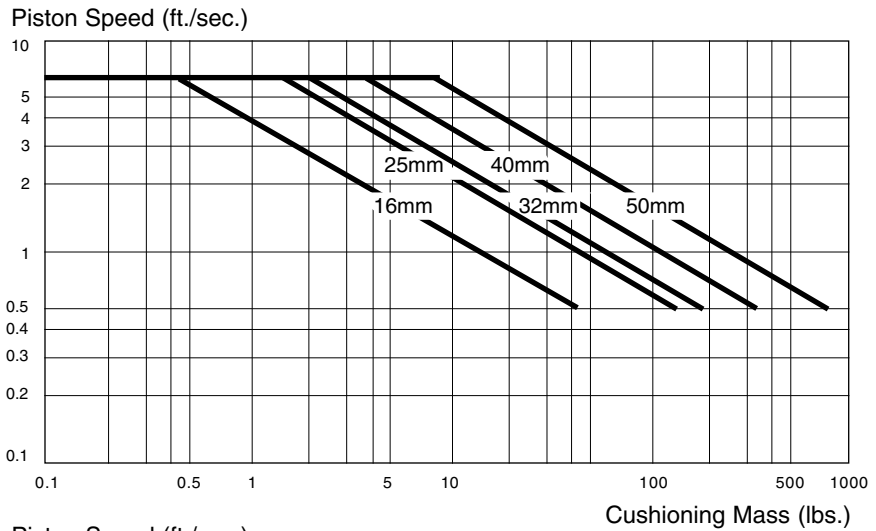

**Cushion Diagram
 Series P120**

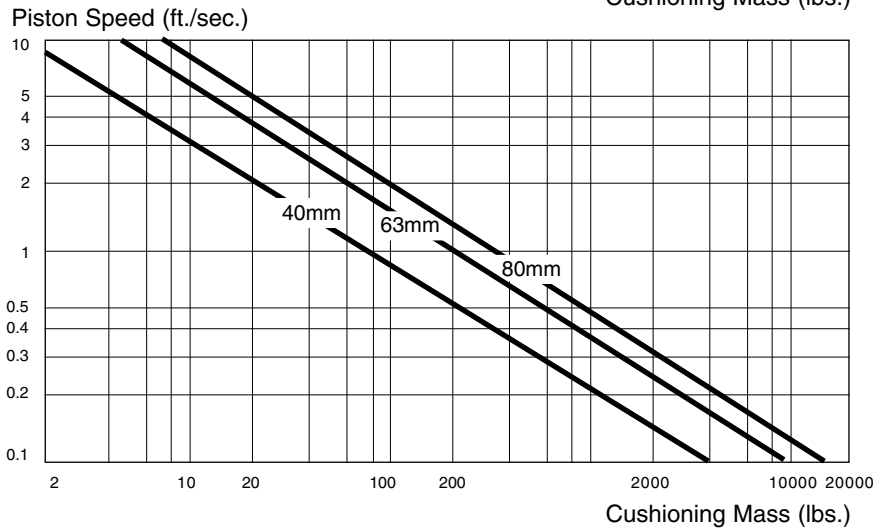

Loading Diagrams

Series 2002

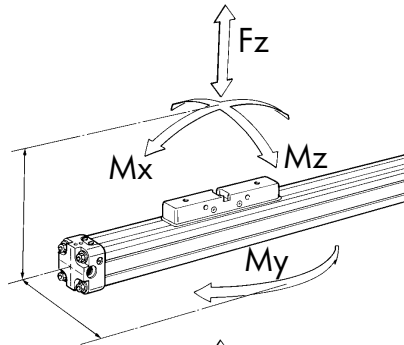

Series 2002
Joint Clamp

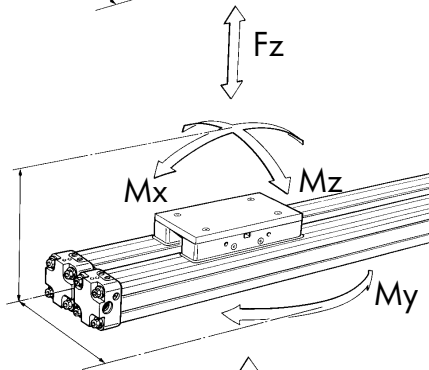

Series P120

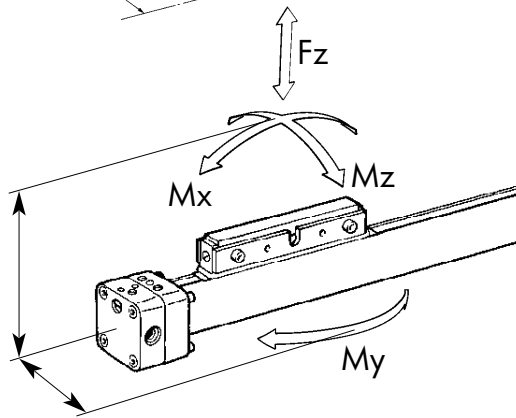

Series 2002
 Basic Cylinder

Bore sizes: 16mm, 25mm, 32mm, 40mm and 50mm. Stroke lengths available up to 480".

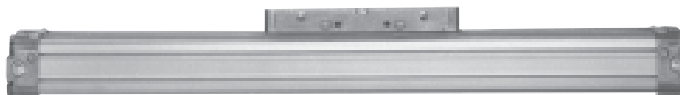

Technical Data
 Loads, forces, moments

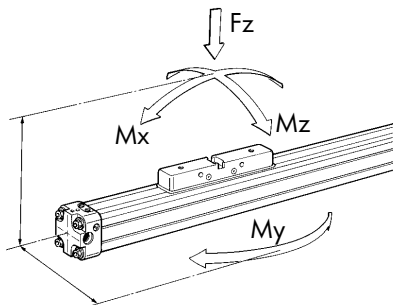

Single Piston Values

Cyl. Ø (mm)	Theoretical Force at 87 PSI (lbs. force)	Cushion Length (in.)	Max. Allowed Bending Moment Mx (in./lbs.)	Max. Allowed Bending Moment Mz (in./lbs.)	Max. Allowed Bending Moment My (in./lbs.)	Max. Allowed Load L (lbs.)
16	27	0.59	35	3	5	30
25	66	0.55	132	9	27	65
32	108	1.10	318	36	120	115
40	169	1.42	575	53	156	195
50	265	1.50	1017	98	312	270

Double Piston Values

Cyl. Ø (mm)	Theoretical Force at 87 PSI (lbs. force)	Cushion Length (in.)	Max. Allowed Bending Moment Mx (in./lbs.)	Max. Allowed Bending Moment Mz (in./lbs.)	Max. Allowed Bending Moment My (in./lbs.)	Max. Allowed Load L (lbs.)
16	27	0.59	81	6	9	60
25	66	0.55	336	18	45	130
32	108	1.10	720	72	600	230
40	169	1.42	1320	106	792	390
50	265	1.50	2304	196	1464	540

Cushioning Diagram

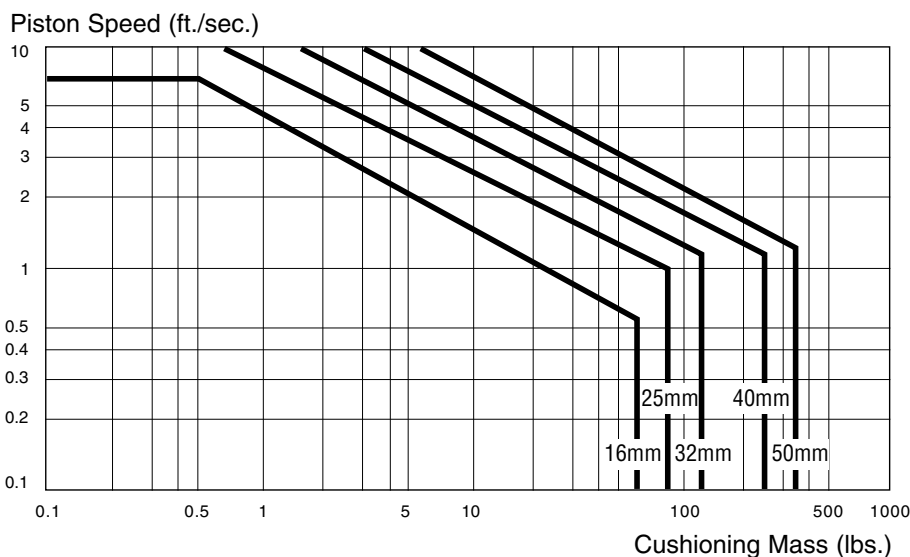

Piston Mountings

Ø 16mm

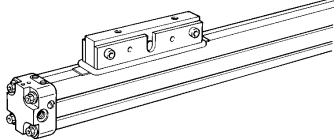
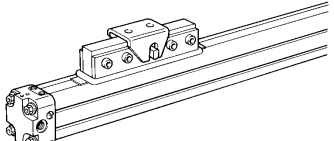
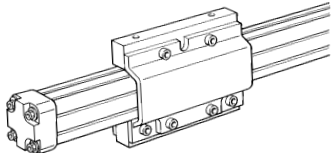
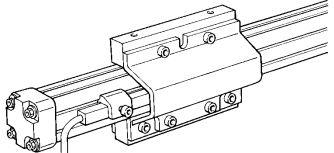
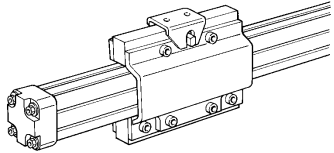
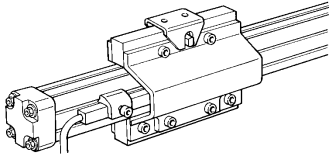
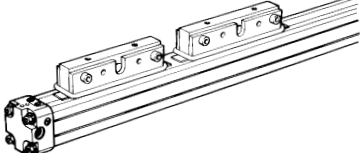
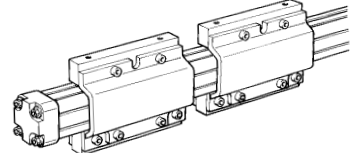
Designation	Pictorial Representation	Description	Cyl. Ø	Weight 0" Stroke (lbs.)	Weight per inch (lbs.)
Type 2020/20		Piston Mounting NR20 Standard mounting. Mounted during cylinder assembly.	16	0.51	0.05
Type 2020/25		Piston Mounting NR25 Allows for a floating connection between the cylinder and an externally guided device.	16	0.55	0.05
Type 2020/30		Piston Mounting NR30 Transfers power to the back of the cylinder. Protects the band surface from foreign particles.	16	0.73	0.05
Type 2020/34		Piston Mounting NR34 Same features as the NR30. For use with cylinders which have sensors on both sides of the barrel.	16	0.77	0.05
Type 2020/35		Piston Mounting NR35 Combines the features of the NR25 mounting and the NR30 mounting.	16	0.77	0.05
Type 2020/37		Piston Mounting NR37 Same features as the NR35. For use with cylinders which have sensors on both sides of the barrel.	16	0.80	0.05
Type 2220/20		Double Piston Mounting NR20 Two pistons in a single barrel using the standard NR20 mounting.	16	0.67	0.05
Type 2220/30		Double Piston Mounting NR30 Two pistons in a single barrel using the NR30 mounting.	16	1.11	0.05

Piston Mountings

Ø 25mm, 32mm, 40mm and 50mm

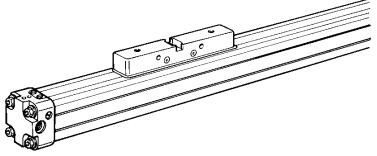
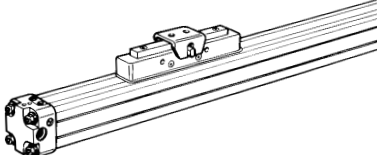
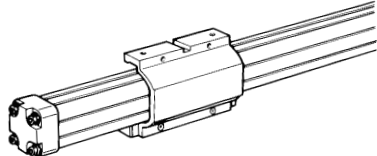
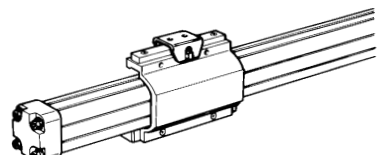
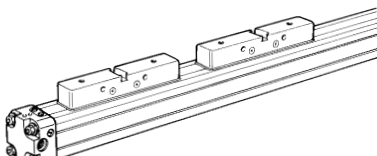
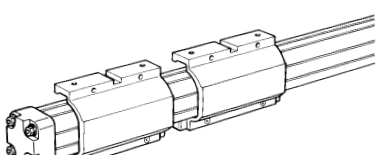
Designation	Pictorial Representation	Description	Cyl. Ø	Weight 0" Stroke (lbs.)	Weight per inch (lbs.)
Type 2020/20		Piston Mounting NR20	25	1.32	0.11
		Standard mounting. Mounted during cylinder assembly.	32	3.19	0.20
			40	5.17	0.29
			50	7.70	0.43
Type 2020/25		Piston Mounting NR25	25	1.54	0.11
		Allows for a floating connection between the cylinder and an externally guided device.	32	3.85	0.20
			40	5.83	0.29
			50	9.46	0.43
Type 2020/30		Piston Mounting NR30	25	1.87	0.11
		Transfers power to the back of the cylinder. Protects the band surface from foreign particles.	32	4.40	0.20
			40	6.60	0.29
			50	10.45	0.43
Type 2020/35		Piston Mounting NR35	25	2.09	0.11
		Combines the features of the NR25 mounting and the NR30 mounting.	32	5.06	0.20
			40	7.26	0.29
			50	12.22	0.43
Type 2220/20		Double Piston Mounting NR20	25	2.05	0.11
		Two pistons in a single barrel using the standard NR20 mounting.	32	5.15	0.20
			40	9.10	0.29
			50	13.20	0.43
Type 2220/30		Double Piston Mounting NR30	25	2.60	0.11
		Two pistons in a single barrel using the NR30 mounting.	32	6.37	0.20
			40	10.31	0.29
			50	15.95	0.43

Overall Dimensions

Ø 16mm

Basic Dimensions (Single Piston)

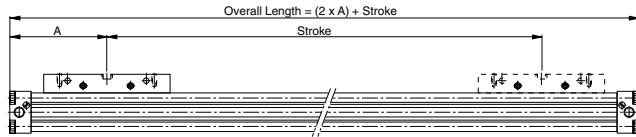

Basic Dimensions (Double Piston)

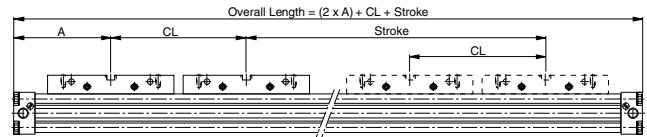

Min. CL Distances: Ø16mm = 3.60

End Cap Dimensions Ø 16mm

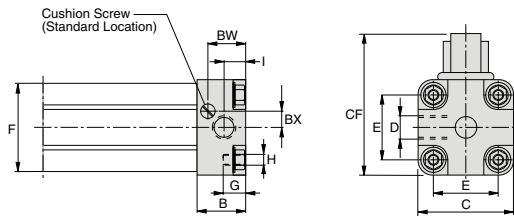

Piston Mounting NR20

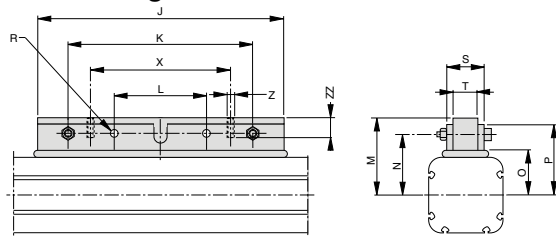

Piston Mounting NR25

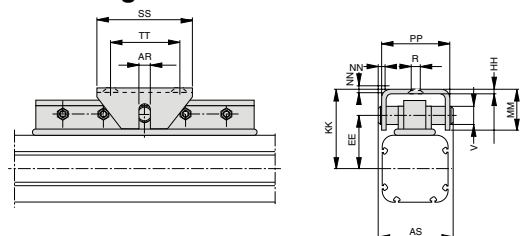

Piston Mounting NR30

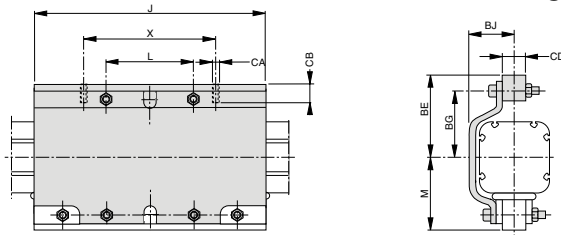

Piston Mounting NR34

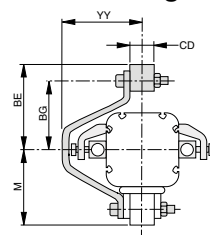

Piston Mounting NR35

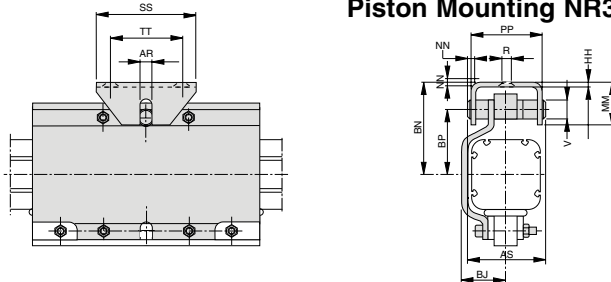

Piston Mounting NR37

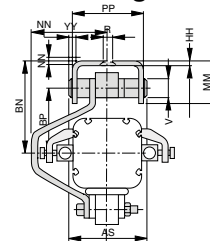

Cyl. Ø	A	B	C	D	E	F	G	H	I	J	K	L	M	N	O	P	R	S	T	V	W	X	Z	AR
16	2.56	.59	1.06	M5	.71	.94	.20	M3	.22	2.99	2.52	1.26	1.18	.94	.63	1.14	.18	.71	.39	.20	—	1.89	M4	.12
Cyl. Ø	AS	BE	BG	BJ	BN	BP	BW	BX	CA	CB	CD	CF	EM	EN	HH	KK	LL	MM	NN	PP	SS	TT	YY	ZZ
16	1.10	1.14	.91	.71	1.30	.91	.47	.16	M4	.47	.63	1.71	—	—	.08	1.34	.96	.51	.06	.98	.79	.39	1.34	.31

Overall Dimensions

Ø 25mm, 32mm, 40mm and 50mm

Basic Dimensions (Single Piston)

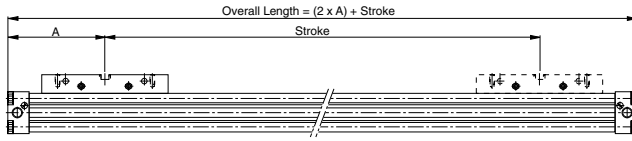

Basic Dimensions (Double Piston)

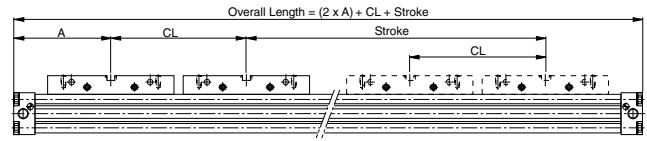

End Cap Dimensions

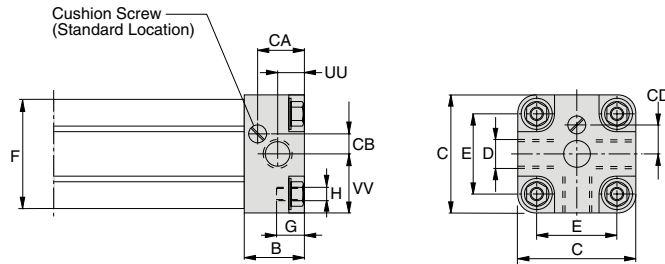

Piston Mounting NR20

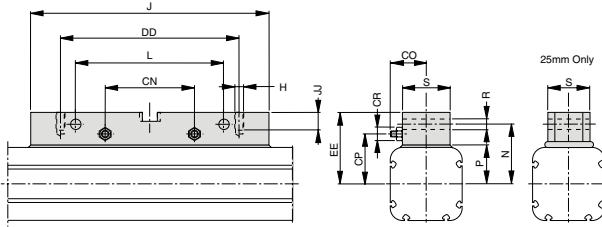

Piston Mounting NR25

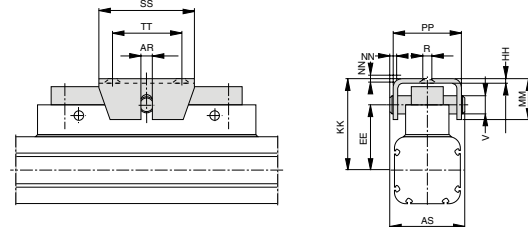

Piston Mounting NR30

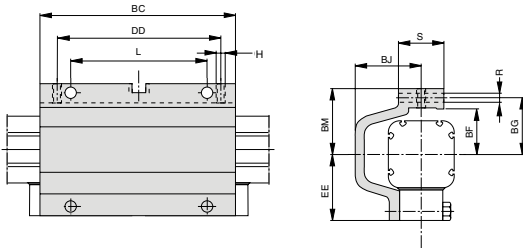

Piston Mounting NR35

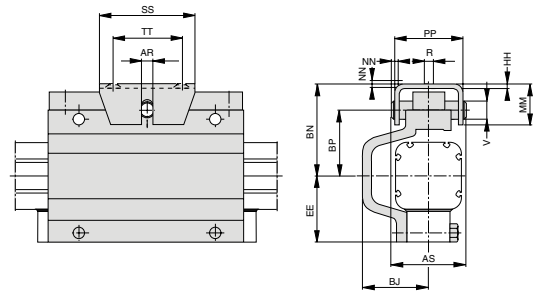

Cyl. Ø	A	B	C	D	E	F	G	H	J	L	N	P	R	S	U	V	DD	EE	HH	JJ	KK
25	3.94	.91	1.57	1/8 NPT	1.06	1.42	.35	10-32	4.72	1.97	1.30	.75	.22	.91	.22	.31	3.15	1.50	.12	.35	2.05
32	4.92	1.06	2.09	1/4 NPT	1.42	1.93	.47	1/4-20	6.30	3.94	1.57	1.10	.26	1.26	.26	.47	4.72	1.89	.16	.47	2.60
40	5.91	1.06	2.48	1/4 NPT	1.81	2.32	.47	1/4-20	6.30	3.94	1.81	1.34	.26	1.26	.26	.47	4.72	2.13	.16	.47	2.83
50	6.70	1.26	3.07	3/8 NPT	2.13	2.83	.47	5/16-18	7.87	5.51	2.17	1.57	.35	1.34	.35	.63	6.30	2.56	.20	.63	3.54
Cyl. Ø	LL	MM	NN	PP	SS	TT	UU	VV	AR	AS	BC	BF	BG	BJ	BM	BN	BP	CA	CB	CD	CL (min.)
25	1.50	.79	±.10	1.46	1.26	.63	.33	.81	.20	1.65	4.25	1.10	1.30	1.50	1.50	2.05	1.50	.71	.26	.35	5.12
32	1.89	1.18	±.16	1.97	2.76	1.97	.41	1.04	.31	2.28	5.67	1.26	1.57	1.89	1.89	2.60	1.89	.83	.35	.51	6.90
40	2.13	1.18	±.16	1.97	2.76	1.97	.41	1.24	.31	2.28	5.67	1.50	1.81	2.13	2.13	2.83	2.13	.71	.51	.65	8.75
50	2.56	1.77	±.24	2.28	3.94	3.15	.49	1.54	.39	2.83	7.24	1.77	2.17	2.56	2.56	3.54	2.56	.83	.59	.73	10.00

Cylinder Mountings

Designation	Pictorial Representation	Description	Cyl. Ø	Part Number	Weight (lbs.)
Type NR4		End Cap Mounting	16	2172-0101	0.02
			25	2172-0201	0.07
			32	2172-0351	0.11
			40	2172-0451	0.13
			50	2172-0551	0.26
Type NR7 (Ø 16mm only)		Center Support	16	2176-0101	0.01
Type NR7 (Ø 25mm - 50mm only)		Center Support	25	2176-0202	0.07
			32	2176-0351	0.13
			40	2176-0451	0.15
			50	2176-0551	0.44
Type NR8 (Ø 25mm - 50mm only)		Center Support	25	2175-0201	0.04
			32	2175-0351	0.07
			40	2175-0451	0.07
			50	2175-0551	0.26

Center Support Placement

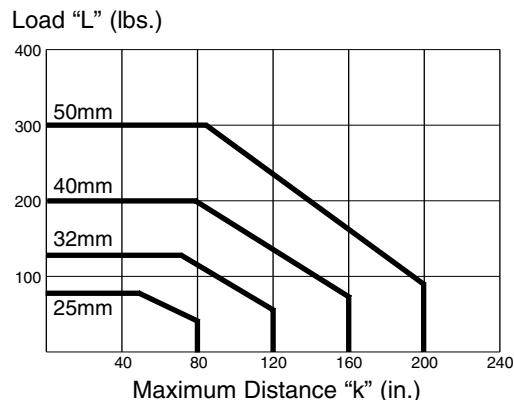
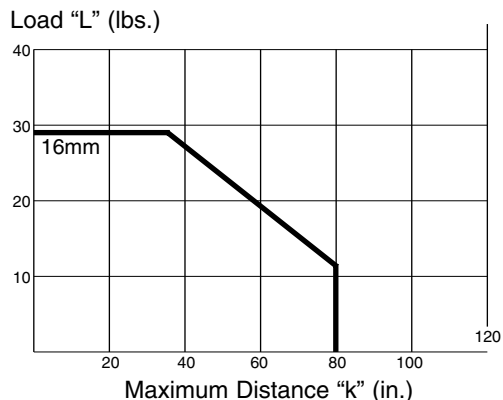
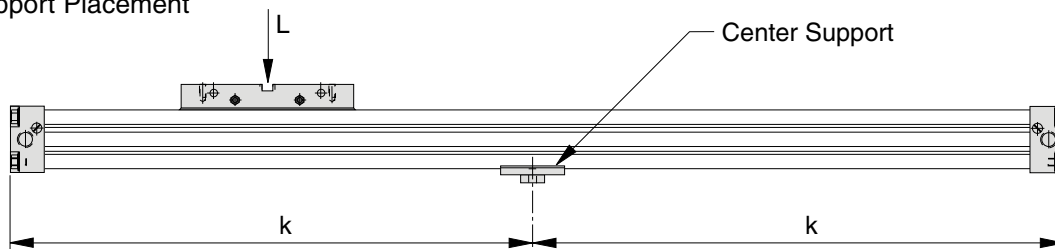

Dimensions – Cylinder Mountings

End Cap Mounting NR4

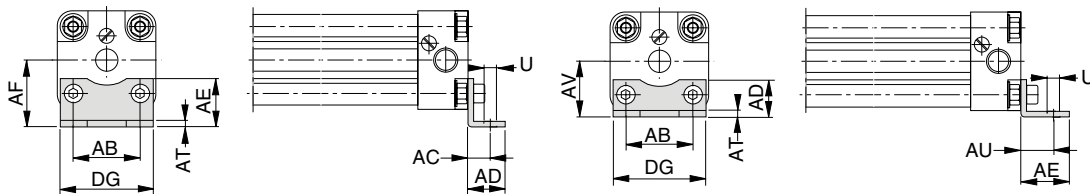

NR4 Mounting Bracket - Mtg. Style "A"

NR4 Mounting Bracket - Mtg. Style "B"

Center Support Mounting NR7 (Ø16mm)

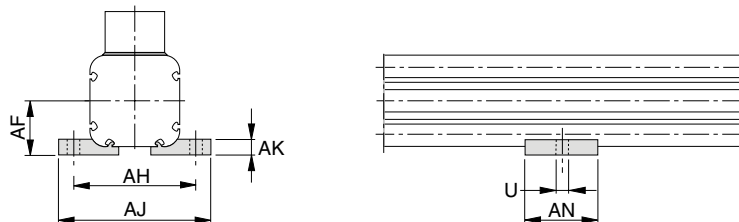

Center Support Mounting NR7 (Ø25mm - 50mm)

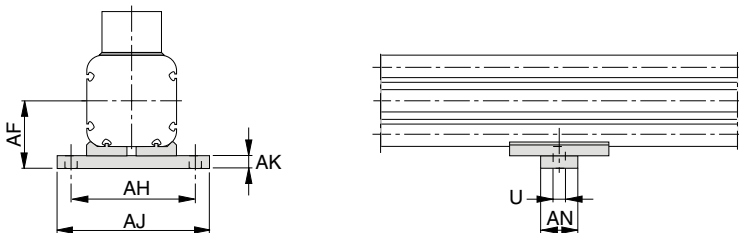

Center Support Mounting NR8

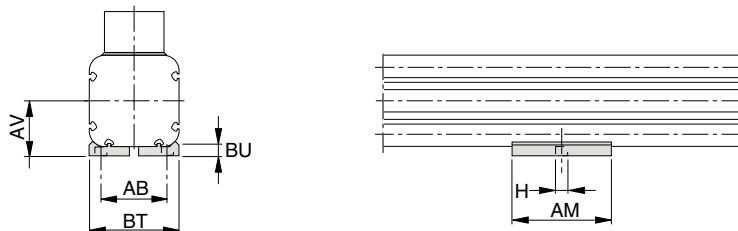

Cyl. Ø	U	AB	AC	AD	AE	AF	AH	AJ	AK	AM	AN	AT	AU	AV	BT	BU	DG	H
16	.14	.71	.39	.55	.49	.59	1.26	1.57	.18	—	.47	.06	—	—	—	—	1.02	—
25	.22	1.06	.41	.71	.87	1.10	1.89	2.36	.16	1.26	.79	.08	.57	.94	1.42	.21	1.54	10-32
32	.26	1.42	.47	.79	1.02	1.42	2.60	3.23	.24	1.57	.79	.12	.71	1.18	1.89	.22	1.97	1/4-20
40	.26	1.81	.47	.79	1.02	1.61	2.99	3.62	.24	1.57	.79	.12	.71	1.38	2.28	.22	2.36	1/4-20
50	.35	2.13	.71	1.10	1.34	2.01	3.70	4.49	.24	2.48	1.57	.16	.94	1.77	2.83	.33	2.91	5/16-18

Series 2002
 Joint Clamps

Bore sizes: 25mm, 32mm, 40mm and 50mm. Stroke lengths available up to 480".



Technical Data
 Loads, forces, moments

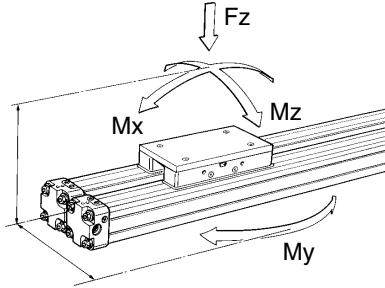

Single Piston Values

Cyl. Ø (mm)	Theoretical Force at 87 PSI (lbs.)	Cushion Length (in.)	Max. Allowed Bending Moment M_x (in./lbs.)	Max. Allowed Bending Moment M_z (in./lbs.)	Max. Allowed Bending Moment M_y (in./lbs.)	Max. Allowed Load L (lbs.)
25	132	0.55	264	115	54	130
32	216	1.10	636	248	240	230
40	338	1.42	1150	444	312	390
50	530	1.50	2034	859	624	540

Double Piston Values

Cyl. Ø (mm)	Theoretical Force at 87 PSI (lbs. force)	Cushion Length (in.)	Max. Allowed Bending Moment M_x (in./lbs.)	Max. Allowed Bending Moment M_z (in./lbs.)	Max. Allowed Bending Moment M_y (in./lbs.)	Max. Allowed Load L (lbs.)
25	132	0.55	672	230	90	260
32	216	1.10	1440	496	1200	460
40	338	1.42	2640	888	1584	780
50	530	1.50	4608	1718	2928	1080

Cushioning Diagram

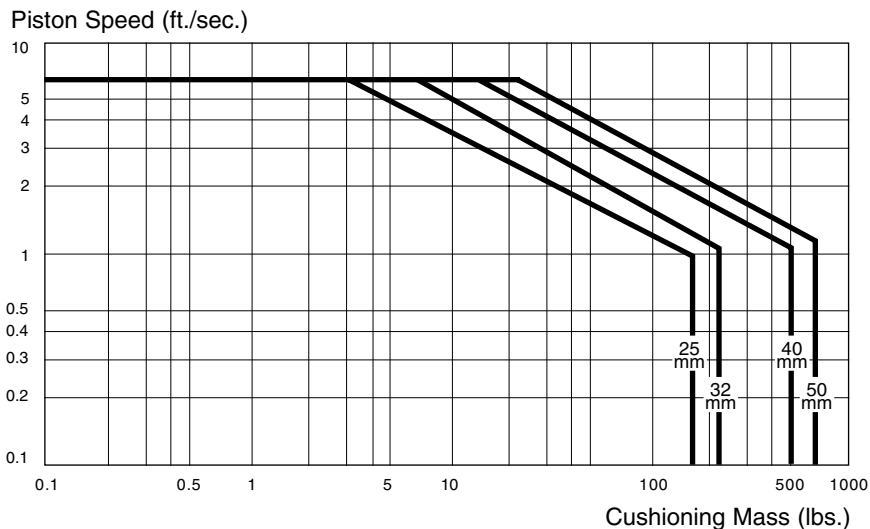

Piston Mountings

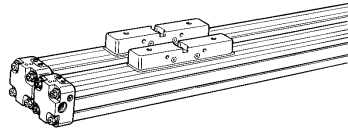
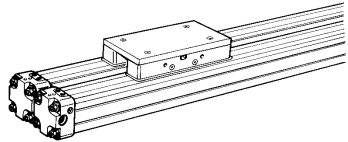
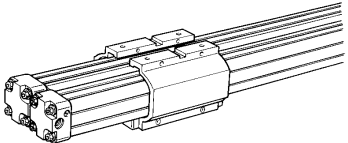
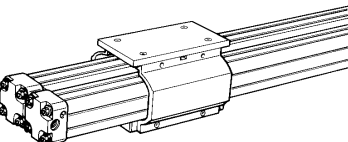
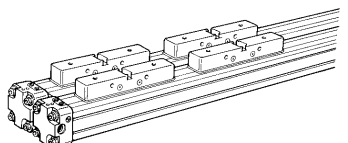
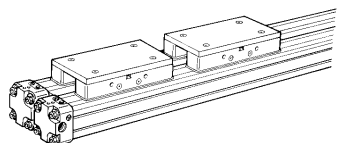
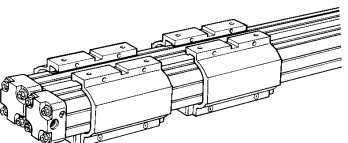
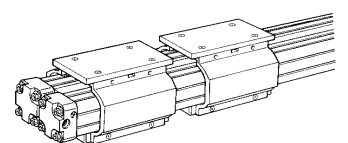
Designation	Pictorial Representation	Description	Cyl. Ø	Weight 0" Stroke (lbs.)	Weight per inch (lbs.)
Type J2020/20		Piston Mounting NR20	25	2.82	0.24
		Standard mounting. Mounted during cylinder assembly.	32	6.84	0.46
			40	10.92	0.63
			50	16.50	0.97
Type J2020/24		Piston Mounting NR24	25	3.24	0.24
		Flat, platform mounting. Provides a common connection across both pistons.	32	7.72	0.46
			40	11.91	0.63
			50	18.70	0.97
Type J2020/30		Piston Mounting NR30	25	3.92	0.24
		Transfers power to the back of the cylinder. Protects the band surface from foreign particles.	32	9.26	0.46
			40	13.77	0.63
			50	22.00	0.97
Type J2020/34		Piston Mounting NR34	25	4.34	0.24
		Combines the features of the NR24 mounting and the NR30 mounting.	32	10.14	0.46
			40	14.76	0.63
			50	24.20	0.97
Type J2220/20		Piston Mounting NR20	25	4.44	0.24
		Two pistons in each barrel using the standard NR20 mounting.	32	11.11	0.46
			40	19.37	0.63
			50	28.60	0.97
Type J2220/24		Piston Mounting NR24	25	5.28	0.24
		Two pistons in each barrel. Provides a common connection across each set of pistons.	32	12.87	0.46
			40	21.35	0.63
			50	33.00	0.97
Type J2220/30		Piston Mounting NR30	25	5.54	0.24
		Two pistons in each barrel using the NR30 mounting. Transfers power to the back of the cylinder.	32	13.55	0.46
			40	21.76	0.63
			50	34.10	0.97
Type J2220/34		Piston Mounting NR34	25	6.38	0.24
		Two pistons in each barrel Combines the features of the NR24 mounting and the NR30 mounting.	32	15.31	0.46
			40	23.74	0.63
			50	38.50	0.97

Overall Dimensions

Basic Dimensions (Single Piston)

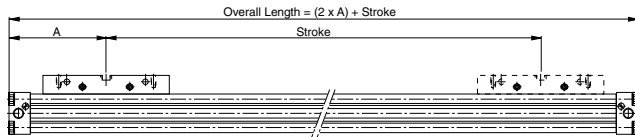

Basic Dimensions (Double Piston)

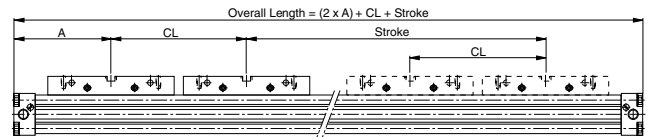

End Cap Cross Section

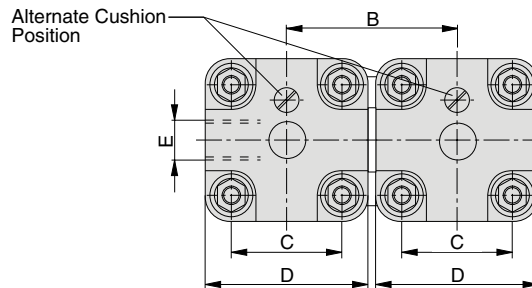

Piston Mounting NR24

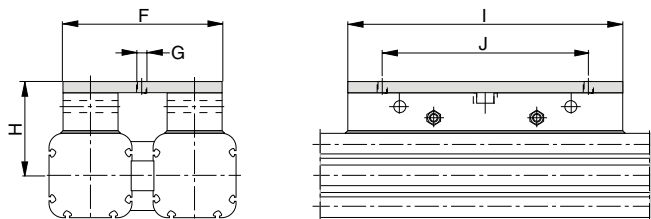

Cylinder Mounting NR8

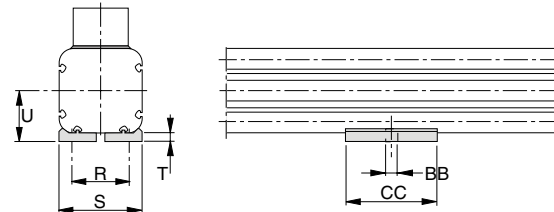

Piston Mounting NR34

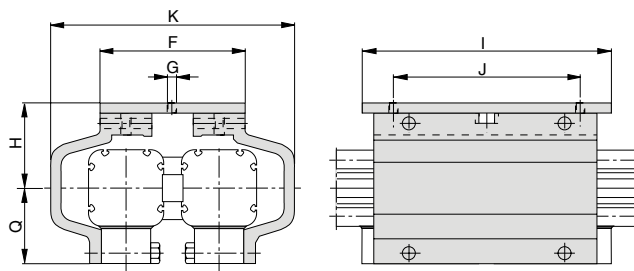

Cylinder Mounting NR17

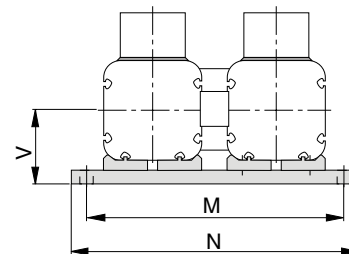

Cyl. Ø	A	B	C	D	E	F	G	H	I	J	K
25	3.94	1.73	1.06	1.57	1/8 NPT	2.76	1/4-20	1.81	4.72	3.15	4.72
32	4.92	2.20	1.42	2.09	1/4 NPT	3.54	5/16-18	2.28	6.30	4.73	5.98
40	5.91	2.60	1.81	2.48	1/4 NPT	3.94	5/16-18	2.52	6.30	4.73	6.86
50	6.70	3.19	2.13	3.07	3/8 NPT	4.73	3/8-16	3.15	7.88	6.30	8.31
Cyl. Ø	M	N	Q	R	S	T	U	V	BB	CC	CL (min.)
25	3.62	4.09	1.50	1.06	1.42	.21	.94	1.10	10-32	.79	5.12
32	4.81	5.44	1.89	1.42	1.89	.22	1.18	1.42	1/4-20	1.57	6.90
40	5.59	6.22	2.13	1.81	2.28	.22	1.38	1.61	1/4-20	1.57	8.75
50	6.89	7.68	2.56	2.13	2.83	.33	1.77	2.01	5/16-18	2.48	10.00

Cylinder Mountings

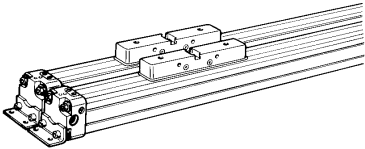
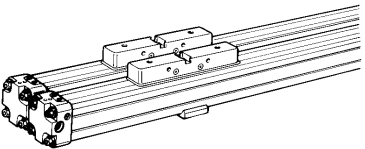
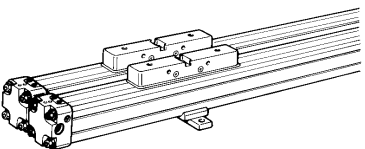
Designation	Pictorial Representation	Description	Cyl. Ø	Part Number	Weight (lbs.)
Type NR4		End Cap Mounting Provides rigid end mounting of the cylinder.	25	2172-0201	0.07
			32	2172-0351	0.11
			40	2172-0451	0.13
			50	2172-0551	0.26
Type NR8 (Ø 25mm - 50mm only)		Center Support Provides stability at cylinder center when heavy loads are traversed over long distances.	25	2175-0201	0.04
			32	2175-0351	0.07
			40	2175-0451	0.07
			50	2175-0551	0.26
Type NR17 (Ø 25mm - 50mm only)		Center Support Provides stability at cylinder center when heavy loads are traversed over long distances.	25	2736-0201	0.13
			32	2736-0351	0.25
			40	2736-0451	0.28
			50	2736-0551	0.84

Orientation Examples

Orientation #1

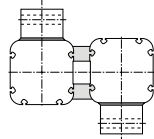

12-6 O'clock

Orientation #2

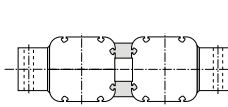

9-3 O'clock

Orientation #3

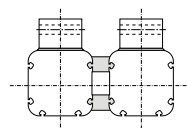

12-12 O'clock

Orientation #4

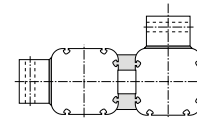

9-12 O'clock

Note: Joint Clamp cylinder loadings will vary depending on the above orientation used. Consult the factory for design assistance.

Series P120

Bore sizes: 40mm, 63mm and 80mm. Stroke lengths available up to 480".



Technical Data

Loads, forces, moments

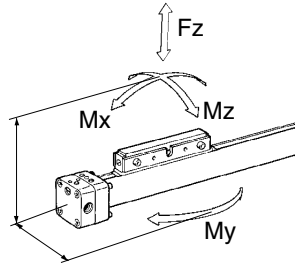

Single Piston Values

Cyl. Ø (mm)	Theoretical Force at 87 PSI (lbs.)	Cushion Length (in.)	Max. Allowed Bending Moment Mx (in./lbs.)	Max. Allowed Bending Moment Mz (in./lbs.)	Max. Allowed Bending Moment My (in./lbs.)	Max. Allowed Load L (lbs.)
40	169	1.26	528	36	72	170
63	420	1.57	1776	72	216	370
80	677	1.73	3192	144	420	590

Double Piston Values

Cyl. Ø (mm)	Theoretical Force at 87 PSI (lbs. force)	Cushion Length (in.)	Max. Allowed Bending Moment Mx (in./lbs.)	Max. Allowed Bending Moment Mz (in./lbs.)	Max. Allowed Bending Moment My (in./lbs.)	Max. Allowed Load L (lbs.)
40	169	1.26	1200	72	216	170
63	420	1.57	3984	144	660	370
80	677	1.73	6372	288	1236	590

Cushioning Diagram

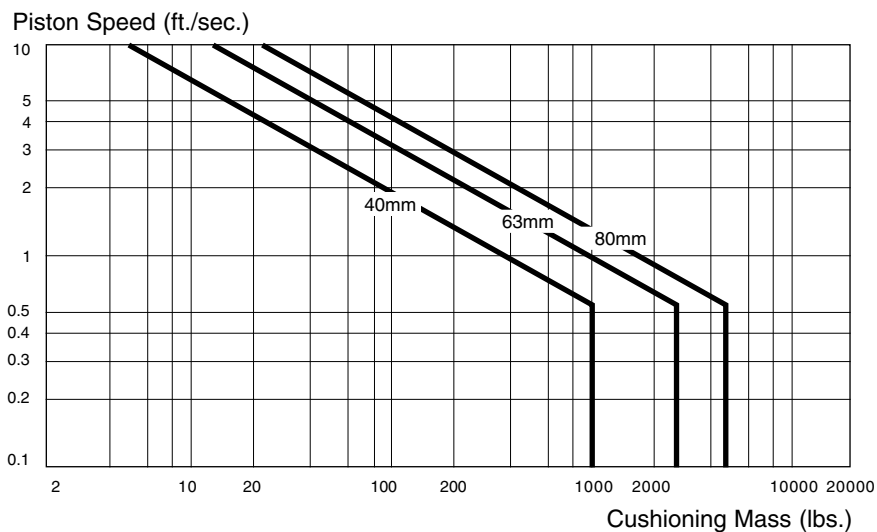

Series P120

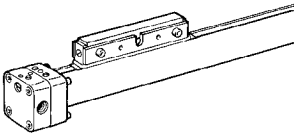
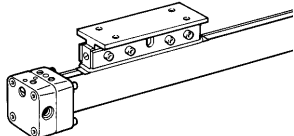
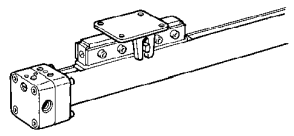
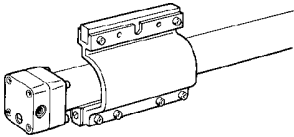
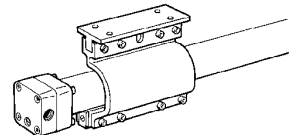
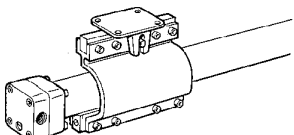
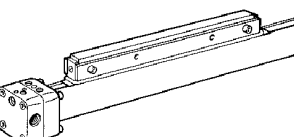
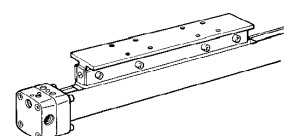
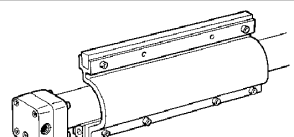
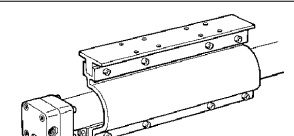
Designation	Pictorial Representation	Description	Cyl. Ø	Weight 0" Stroke (lbs.)	Weight per inch (lbs.)
Type P120-S/20		Piston Mounting S/20	40	7.26	0.20
		Standard mounting. Mounted during cylinder assembly.	63	20.46	0.45
			80	35.42	0.71
Type P120-S/22		Piston Mounting S/22	40	7.48	0.20
		Flat, platform mounting	63	20.90	0.45
			80	36.74	0.71
Type P120-S/25		Piston Mounting S/25	40	7.92	0.20
		Allows for a floating connection between the cylinder and an externally guided device.	63	22.66	0.45
			80	38.06	0.71
Type P120-S/30		Piston Mounting S/30	40	9.24	0.20
		Transfers power to the back of the cylinder. Protects the band surface from foreign particles.	63	25.74	0.45
			80	44.88	0.71
Type P120-S/32		Piston Mounting S/32	40	9.46	0.20
		Combines the features of the S/22 mounting and the S/30 mounting.	63	26.18	0.45
			80	46.20	0.71
Type P120-S/35		Piston Mounting S/35	40	9.90	0.20
		Combines the features of the S/25 mounting and the S/30 mounting.	63	27.94	0.45
			80	47.52	0.71
Type P120-L/26		Piston Mounting L/26	40	11.00	0.20
		Standard mounting. Mounted during cylinder assembly.	63	30.58	0.45
			80	51.04	0.71
Type P120-L/28		Piston Mounting L/28	40	11.44	0.20
		Flat, platform mounting.	63	32.12	0.45
			80	53.68	0.71
Type P120-L/36		Piston Mounting L/36	40	14.74	0.20
		Transfers power to the back of the cylinder. Protects the band surface from foreign particles.	63	42.02	0.45
			80	70.40	0.71
Type P120-L/38		Piston Mounting L/38	40	15.18	0.20
		Combines the features of the L/28 mounting and the L/36 mounting.	63	43.56	0.45
			80	73.04	0.71

Overall Dimensions

Basic Dimensions

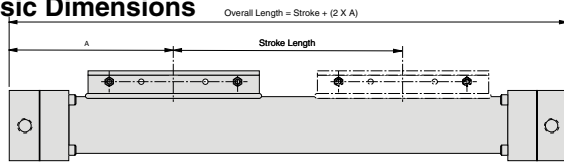

End Cap Dimensions

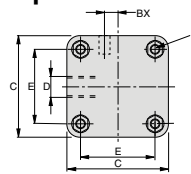

Piston Mounting S/20

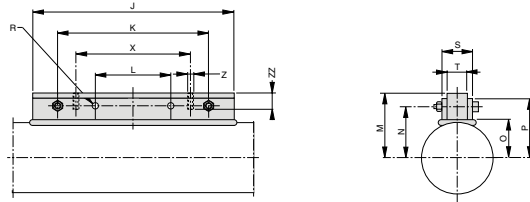

Piston Mounting L/26

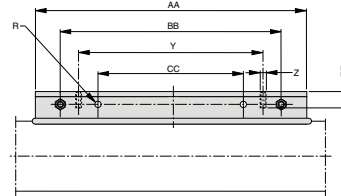

Piston Mounting S/22

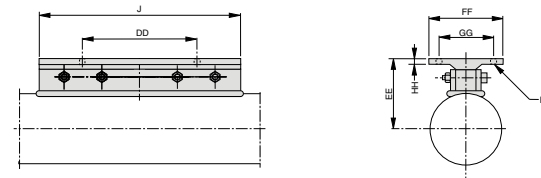

Piston Mounting L/28

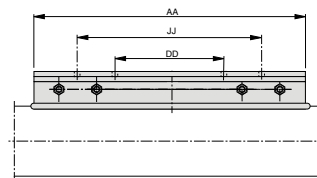

Piston Mounting S/25

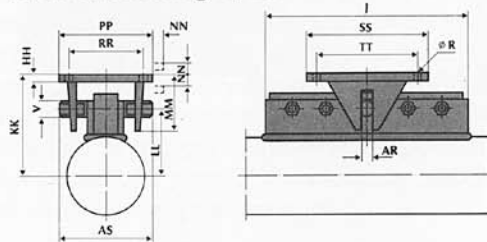

S/30

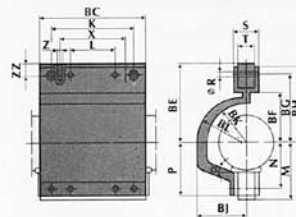

L/36

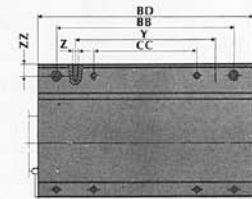

Piston Mounting S/35

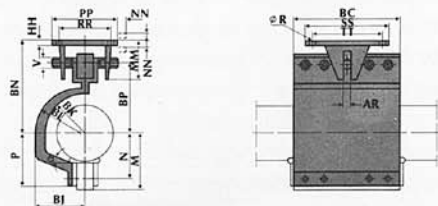

S/32

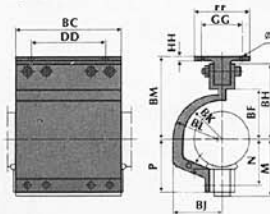

L/38

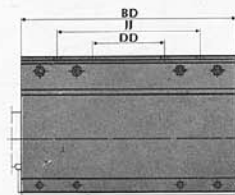

Cyl. Ø	A (S)	A (L)	B	C	D	E	F	G	H	I	J	K	L	M	N	O	P	R	S
40	5.91	9.91	2.36	2.83	1/4 NPT	2.13	2.28	.59	1/4-20	.59	5.91	4.33	2.17	2.40	1.93	1.28	2.24	.28	1.10
63	8.46	14.46	3.15	4.17	3/8 NPT	3.07	3.46	.79	5/16-18	.79	8.66	7.09	3.54	3.27	2.68	1.89	3.07	.35	1.18
80	10.24	16.24	3.94	5.20	1/2 NPT	3.78	4.41	.98	3/8-16	.98	11.02	9.45	4.72	3.98	3.27	2.36	3.74	.43	1.26
Cyl. Ø	T	V	Y	AA	AR	AS	BB	BC	BD	BE	BF	BG	BH	BJ	BK	BL	BM	BN	BP
40	.71	.47	7.09	11.81	.31	3.31	9.45	5.43	11.34	3.35	2.30	2.87	3.19	2.09	1.65	1.89	3.54	3.90	2.95
63	.75	.63	11.81	18.90	.39	3.54	15.75	8.19	18.43	4.61	3.23	4.02	4.41	3.03	2.44	2.80	4.84	5.28	4.11
80	.79	.79	14.17	22.05	.51	4.33	18.90	10.55	21.57	5.63	4.02	4.92	5.39	3.78	3.07	3.46	5.91	6.42	5.04
Cyl. Ø	BW	BX	CC	DD	EE	FF	GG	HH	JJ	KK	LL	MM	NN	PP	RR	SS	TT	ZZ	α
40	.59	.43	4.72	3.15	2.60	2.36	1.77	.24	6.30	2.95	2.00	1.26	±.32	2.76	2.17	3.54	2.95	.47	22°
63	.79	.59	7.87	5.12	3.50	3.15	2.36	.28	10.24	3.94	2.76	1.54	±.39	3.54	2.76	4.72	3.94	.63	15°
80	.98	.63	9.45	7.09	4.25	3.94	2.95	.31	14.17	4.80	3.39	1.89	±.47	4.33	3.35	5.91	4.92	.79	15°

Cylinder Mountings

Designation	Pictorial Representation	Description	Cyl. Ø	Part Number	Weight (lbs.)
Type NR3		End Cap Lug Mount	40	2170-0451	0.22
			63	2170-0651	0.66
			80	2170-0851	1.32
Type NR8		Center Support	40	4040	1.32
			63	6040	3.74
			80	8040	6.38
Type NR9		Center Support	40	4030	1.32
			63	6030	3.74
			80	8030	7.26

End Cap Lug Mount NR3

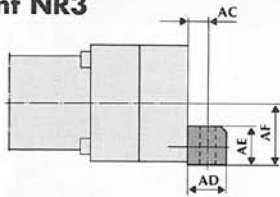
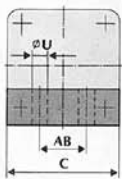

Mid-section Support No. 8

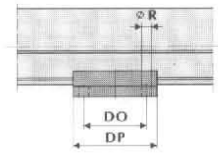
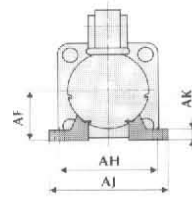

Position of Cylinder Mountings

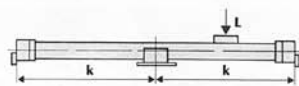
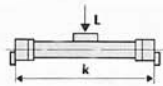
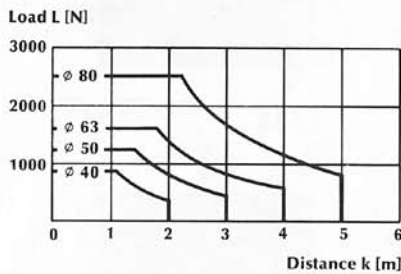

Center Support NR9

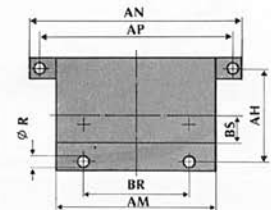
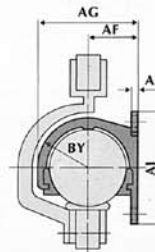

Cyl. Ø	C	R	U	AB	AC	AD	AE	AF	AG	AH	AJ	AK	AL	AM	AN	AP	BR	BS	BY	DO	DP
40	2.83	.28	.35	1.18	.49	.94	.94	1.50	2.99	2.76	3.35	.31	2.32	4.72	6.30	5.71	3.15	.83	1.50	1.77	2.36
63	4.17	.35	.43	1.89	.59	1.18	1.57	2.24	4.49	3.74	4.49	.39	3.50	6.30	8.27	7.48	3.94	1.26	2.24	1.77	2.36
80	5.20	.43	.55	2.36	.69	1.38	1.97	2.83	5.67	4.72	5.67	.47	4.41	7.87	10.23	9.25	4.72	1.57	2.83	2.77	3.15

Type RS

In the type RS contact is made by a mechanical **reed switch** encapsulated in glass.

Direct connection with 2-pole cable, 5 m long, open ended (**Type RS-K**).

Type ES

In the type ES contact is made by an **electronic switch** – without bounce or wear and protected from pole reversal. The output is short circuit proof and insensitive to shocks and vibrations. Connection is by 3-pole connector for easy disconnection. Fitted with connection cable 100 mm long with connector.

A 5 m cable with connector and open end can be ordered separately, or use the Order No. for the complete Type ES with 5 m cable.

**Magnetic Switches
RS and ES**

**Electrical Service Life
Protective Measures**

Magnetic switches are sensitive to excessive currents and inductions. With high switching frequencies and inductive loads such as relays, solenoid valves or lifting magnets, service life will be greatly reduced.

With **resistive and capacitive loads** with high switch-on current, such as light bulbs, a protective resistor should be fitted. This also applies to long cable lengths and voltages over 100 V.

In the switching of inductive loads such as relays, solenoid valves

and lifting magnets, voltage peaks (transients) are generated which must be suppressed by protective diodes, RC loops or varistors.

Connection Examples

- Load with protective circuits
- (a) Protective resistor for light bulb
- (b) Freewheel diode on inductivity
- (c) Varistor on inductivity
- (d) RC element on inductivity

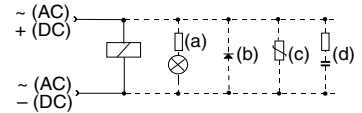

For the type ES, external protective circuits are not normally needed.

Electrical Connection, Type RS

Normally closed (NC)

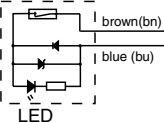

Normally open (NO)

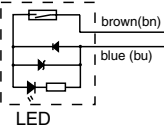

Dimensions (mm) – Type RS-K

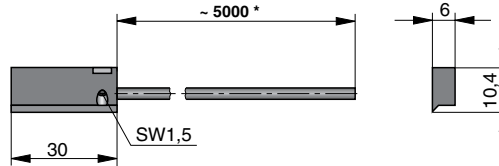

* Length with possible minus tolerance, see chart below

Electrical Connection, Type ES

**Standard Version:
Type PNP**

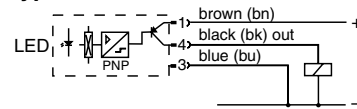

**Optional Version
Type NPN**

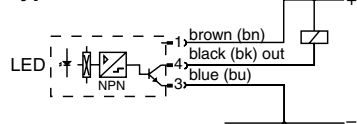

Dimensions (mm) – Type ES-S

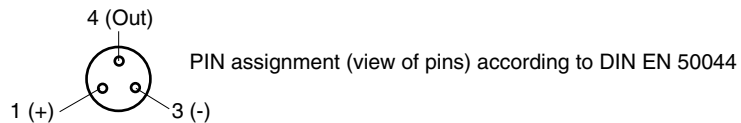
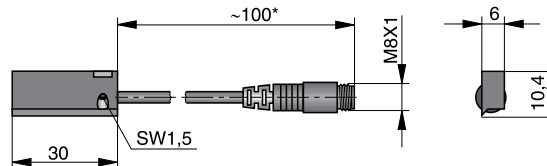

* Length with possible minus tolerance, see chart below

Length of connection cable with length tolerance

Magnetic Switch Order No.	Nominal cable length	Length tolerance
KL3045	5000 mm	-50 mm
KL3048	100 mm	-20 mm
10750	5000 mm	-50 mm
10751	145 mm	±5 mm

Type RST

In the type RST contact is made by a mechanical **reed switch** encapsulated in glass.

Type EST

In the type EST contact is made by an **electronic switch** – without bounce or wear and protected from pole reversal. The output is short circuit proof and insensitive to shocks and vibrations. Connection is by 3-pole connector for easy disconnection. Fitted with connection cable 100 mm long with connector. A 5 m cable with connector and open end can be ordered separately, or use the Order No. for the complete

Type ES with 5 m cable.

**Magnetic Switches
RST and EST**

**Electrical Service Life
Protective Measures**

Magnetic switches are sensitive to excessive currents and inductions. With high switching frequencies and inductive loads such as relays, solenoid valves or lifting magnets, service life will be greatly reduced.

With **resistive and capacitive loads** with high switch-on current, such as light bulbs, a protective resistor should be fitted. This also applies to long cable lengths and voltages over 100 V.

In the switching of inductive loads

such as relays, solenoid valves and lifting magnets, voltage peaks (transients) are generated which must be suppressed by protective diodes, RC loops or varistors.

Connection Examples

- Load with protective circuits
- (a) Protective resistor for light bulb
- (b) Freewheel diode on inductivity
- (c) Varistor on inductivity
- (d) RC element on inductivity

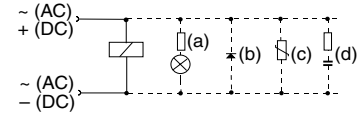

For the type EST, external protective circuits are not normally needed.

**Electrical Connection
Type RST-K**

Normally closed

Normally open

**Electrical Connection
Type EST-K**

**Electrical Connection
Type RST-S**

**Electrical Connection
Type EST-S**

Dimensions (mm) – Type RST-K, EST-K

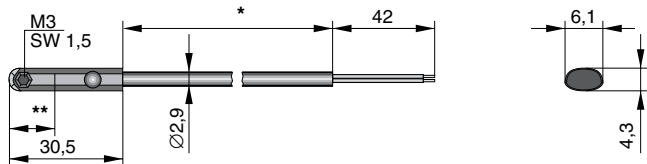

* Cable lengths available: 5000 mm ± 75 mm
2000 mm ± 40 mm

** Switching point: Type RST-K Normally closed 14 mm
Type RST-K Normally open 12.3 mm
Type EST-K Normally open 8.1 mm

Dimensions (mm) – Type RST-S, EST-S

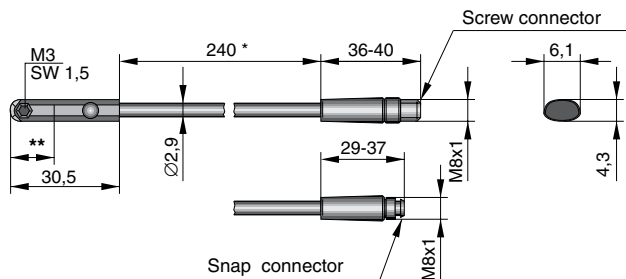

* ± 6 mm

** Switching point: Type RST-K Normally closed 14 mm
Type RST-K Normally open 12.3 mm
Type EST-K Normally open 8.1 mm

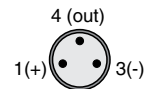

PIN assignment
(view of pins)
to DIN EN 50044

Installation

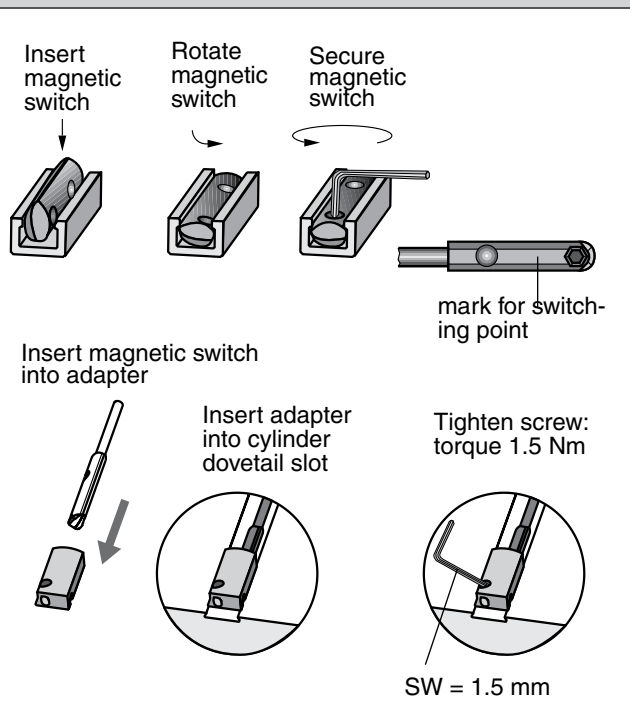

Dimensions of Adapter for Magnetic Switch

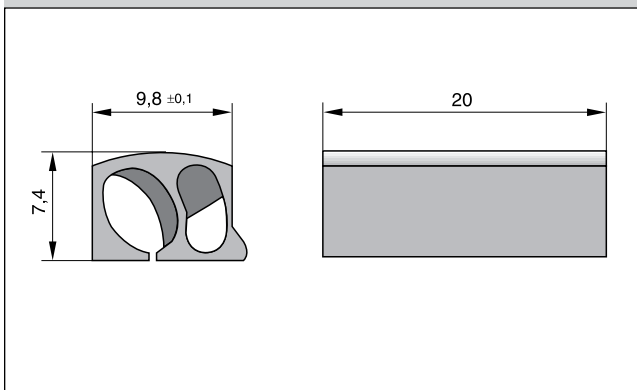

Ordering Information

Type	Voltage	Order No.
RST-K	10-30V AC/DC	KL3300
EST-S	10-30V DC	KL3312

Spare Parts

Series 2002 - Basic Cylinder - Ø16mm

Item	Description	16mm
1	Cylinder Barrel	2152-0101+S
2***	Outer Band	2080-0101+S
3***	Inner Band	2192+0101+S
4	End Cap - Right (B)	2164-0154
4.1	End Cap - Right (V)	2714-0154
5	O-Ring - Cushion Screw (B)	0766
5.1	O-Ring - Cushion Screw (V)	0767
6	Cushion Screw	0734
7	N/A	
8	O-Ring - Cushion Pipe (B)	0732
8.1	O-Ring - Cushion Pipe (V)	0733
9	End Cap - Left (B)	2164-0153
9.1	End Cap - Left (V)	2714-0153
10	O-ring Gasket End Cap (B)	N/A
10.1	O-ring Gasket End Cap (V)	N/A
11	Screw - Outer Band Lock	0847
12	Outer Band Lock	0738
13	Screw - Inner Band Lock	0846
14	Inner Band Lock	0736
15	End Cap Screw	0735
19	Cushion Pipe	N/A
**	Service Pack-1 Piston (B)	SP16-B-1 xS
**	Service Pack-1 (V)	SP16-V-1 xS
**	Service Pack-2 (B)	SP16-B-2 xS
**	Service Pack-2 (V)	SP16-V-2 xS
	Seal Kit-1 (B)	2790-0101
	Seal Kit-1 (V)	2791-0101
	Seal Kit-2 (B)	2790-0101-2
	Seal Kit-2 (V)	2791-0101-2

(B) = Buna-N

(V) = Viton

**Note: Please identify stroke "S" required when ordering.

*** Note: These items can only be purchased in a service pack.

Item	Description	16mm
20	Piston Seal (B)	0745
20.1	Piston Seal (V)	0746
21	Cushion Seal (B)	0751
21.1*	Cushion Seal (V)	0752
22	Complete Piston	1853
23	Screw - Piston Mount	0754
24	Bearing Strip	2798-0101
25	Nut - Piston Mount	0796
26	Scraper	2238-0101
27	Piston Mount - NR20	1815
28	Bracket - NR25 Mount	N/A
29	Fork Bracket	0758
31	O-ring - Yoke (B)	0747
31.1	O-ring - Yoke (V)	0748

(B) = Buna-N

(V) = Viton

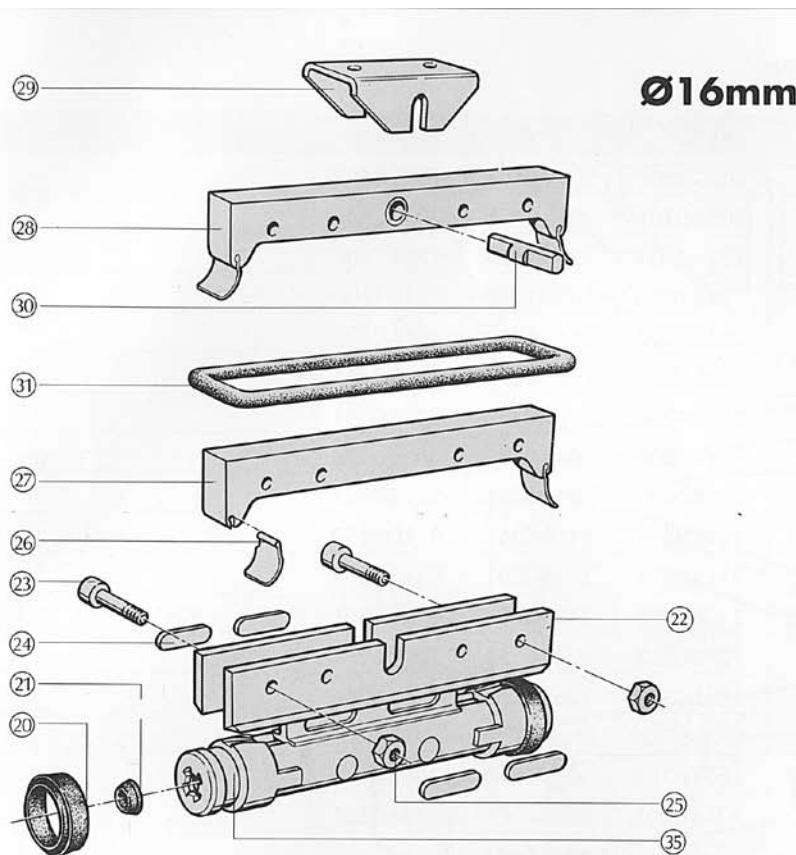
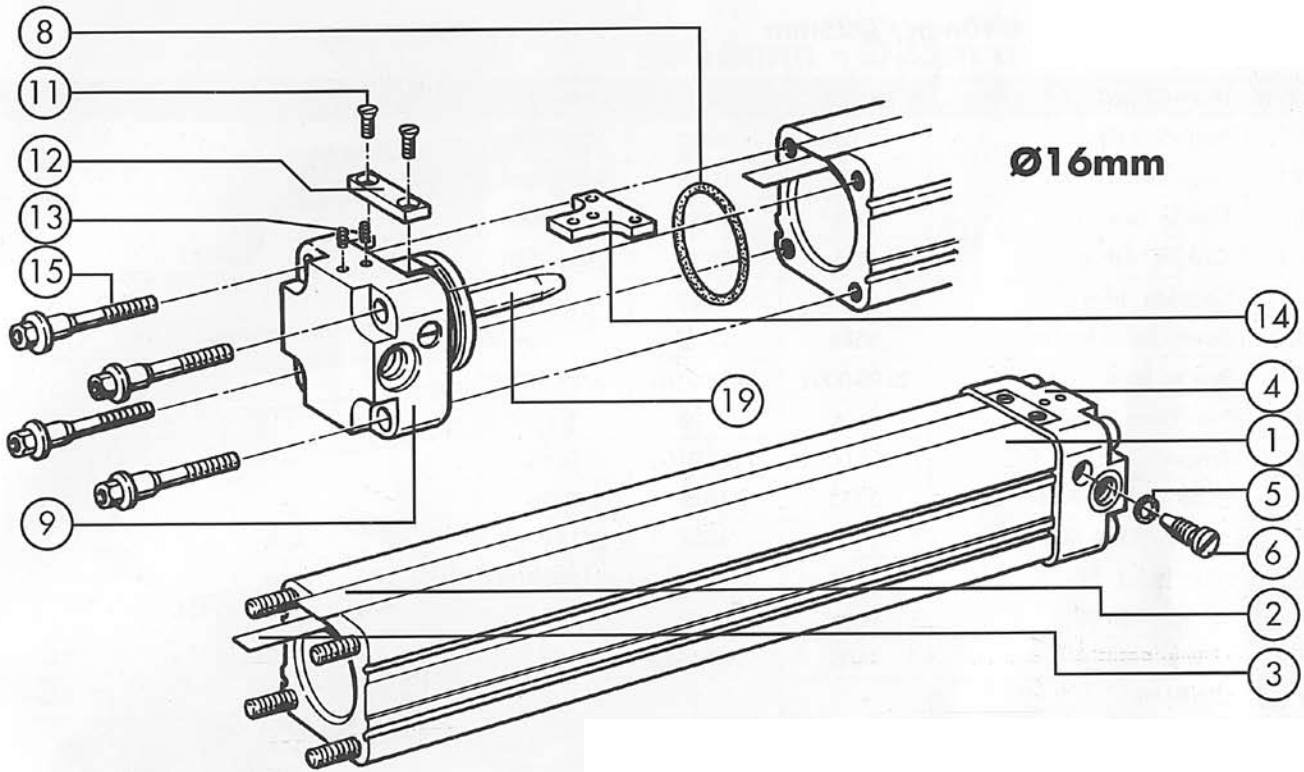

**Series 2002 - Basic Cylinder -
Ø25mm - Ø50mm**

Item	Description	Kit to Purchase
1	Barrel	Purchase Separate
2	Magnet Strip	Purchase Separate
3	Inner Band	Service Pack
4	Outer Band	Service Pack
5	Piston Mount Screw	Piston Mount Kit
6	Outer Bandlock Screw	End Cap Assembly
7	Piston	Piston Assembly Kit
8	Support Ring (White, Red, Green)	Piston Assembly Kit
9	Slide Shoe (Yellow, Tan, Black)	Seal Kit
10	Piston Mounting	Piston Mount Kit
11	Scraper	Seal Kit
12	Slide Wiper	Seal Kit
13	Magnet	Piston Assembly Kit
14A	Magnet Holder (Aluminum)	Piston Assembly Kit
14B	Magnet Holder (Steel)	Piston Assembly Kit
15	Piston Seal	Seal Kit
16	Cushion Seal	Seal Kit
17	End Cap - Left Hand	End Cap Assembly
18	End Cap - Right Hand	End Cap Assembly
19	Cushion Pipe	End Cap Assembly

Item	Description	Kit to Purchase
20	Inner Band Lock	End Cap Assembly
21	Shim Piece	End Cap Assembly
22	Cushion Disc	Seal Kit
23	Cushion Adjustment Screw	End Cap Assembly
24	Outer Band Lock	End Cap Assembly
25	End Cap Screw	End Cap Assembly
26	Locking Ring	Purchase Separate
27	O-ring End Cap	Seal Kit
28	O-Ring - Cushion Screw	Seal Kit
29	Screw - Inner Band Lock	End Cap Assembly

* See page 33 for ordering instructions on kit part numbers.

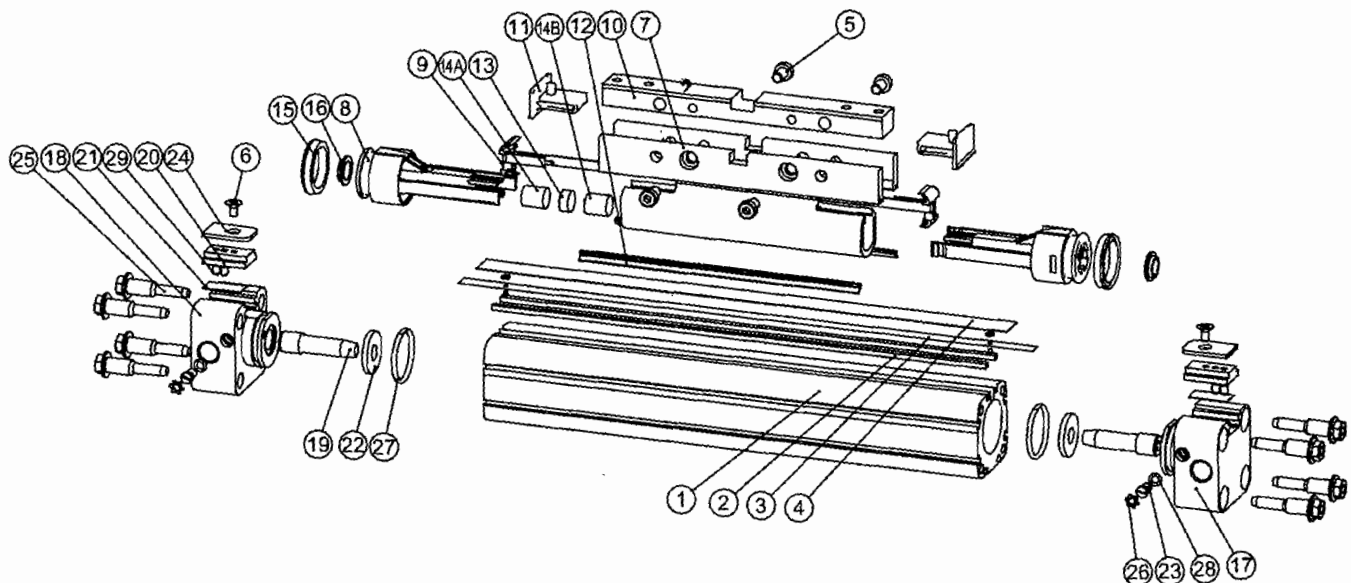

NOTE: FOR 25mm ONLY, ITEMS 23, 26 & 28 ARE AN INTEGRAL PART OF THE CAP (ITEMS 17 & 18)

Description		25mm	32mm	40mm	50mm
Barrel	Part Number	2152-0201 +S	2152-0301 +S	2152-0404 +S	2152-0502 +S
Magnetic Strip	Part Number	2244-0201 +S	2244-0301 +S	2244-0451 +S	2244-0501 +S

Piston Assembly Kits – includes seals, bearings, support rings, magnets and holders

Description		25mm	32mm	40mm	50mm
(Buna)	Part Number	2002-25-PISTON-B	2002-32-PISTON-B	2002-40-PISTON-B	2002-50-PISTON-B
(Viton)	Part Number	2002-25-PISTON-V	2002-32-PISTON-V	2002-40-PISTON-V	2002-50-PISTON-V

End Cap Assembly Kits – includes end cap set with cushion pipes, o-rings, cap screws, cushion discs, and hand locks

Description		25mm	32mm	40mm	50mm
US Threads (Buna)	Part Number	2002-25-END-CAP-B	2002-32-END-CAP-B	2002-40-END-CAP-B	2002-50-END-CAP-B
US Threads (Viton)	Part Number	2002-25-END-CAP-V	2002-32-END-CAP-V	2002-40-END-CAP-V	2002-50-END-CAP-V
Metric Threads (Buna)	Part Number	2002-25-END-CAP-MO	2002-32-END-CAP-MO	2002-40-END-CAP-MO	2002-50-END-CAP-MO
Metric Threads (Viton)	Part Number	2002-25-END-CAP-V-MO	2002-32-END-CAP-V-MO	2002-40-END-CAP-V-MO	2002-50-END-CAP-V-MO

Piston Assembly Kits – includes piston mount, scrapers and screws

Description		25mm	32mm	40mm	50mm
US Threads	Part Number	2002-25-PISTON-MT	2002-32-PISTON-MT	2002-40-PISTON-MT	2002-50-PISTON-MT

Spare Parts

Series P120 - Basic Cylinder - Ø40mm - Ø80mm

Item	Description	40mm	63mm	80mm
1	Cylinder Barrel S/	2152-0403+S	2152-0602+S	2152-0801+S
1.1	Cylinder Barrel L/	2153-0452+S	2153-0651+S	2153-0851+S
1.2	Magnet Strip	2244+0401+S	2244-0601+S	2074-0801
2***	Outer Band S/	2080-0403+S	2080-0603+S	2080-0801+S
2.1***	Outer Band L/	2081-0451+S	2081-0651+S	2081-0851+S
3***	Inner Band S/	2192-0402+S	2192-0602+S	2192-0802+S
3.1***	Inner Band L/	2193-0451+S	2193-0652+S	2193-0851+S
4	End Cap - Right (B)	2164-0454-R	2164-0654-R	2164-0852-R
4.1	End Cap - Right (V)	2714-0452-R	2714-0652-R	2714-0851-R
5	O-Ring - Cushion Screw (B)	1252-0101	1252-0101	1252-0101
5.1	O-Ring - Cushion Screw (V)	1262-0101	1262-0101	1262-0101
6	Cushion Screw	1213	1257	1257
7	Lock Ring - Upper/Lower	1207	1254	1263
8	Screw - End Cap	1004-0718	1004-0920	1004-1124
9	Cap Ring	2887	2889	1262
10	O-Ring - End Cap (B)	1250-0307	1250-0503	1250-0506
10.1	O-Ring - End Cap (V)	1261-0307	1261-0503	1261-0506
11	End Cap - Left (B)	2164-0454-L	2164-0654-L	2164-0852-L
11.1	End Cap - Left (V)	2714-0452-L	2714-0652-L	2714-0851-L
12	Inner Band Lock Set	4833	6833	8833
13	Screw - Inner Band Lock	1024-0605	1024-0605	1024-0807
14	Plug - Cap Ring	2847	2847	2847
15	Screw - Outer Band Lock	1033-0505	1033-0506	1033-0506
16	Outer Band Lock	1204	1204	1204
**	Service Pack-Short Piston (B)	SP124-B-S xS	SP126-B-S xS	SP128-B-S xS
**	Service Pack-Short Piston (V)	SP124-V-S xS	SP126-V-S xS	SP128-V-S xS
**	Service Pack-Long Piston (B)	SP124-B-L xS	SP126-B-L xS	SP128-B-L xS
**	Service Pack-Long Piston (V)	SP124-V-L xS	SP126-V-L xS	SP128-V-L xS
	Seal Kit-Short Piston (B)	2790-0401	2790-0601	2790-0801
	Seal Kit-Short Piston (V)	2791-0401	2791-0601	2791-0801
	Seal Kit-Long Piston (B)	2792-0401	2792-0601	2792-0801
	Seal Kit-Long Piston (V)	2793-0401	2793-0601	2793-0801

(B) = Buna-N

(V) = Viton

**Note: Please identify stroke "S" required when ordering.

***Note: These items can only be purchased in a service pack.

Series P120 - Cylinder

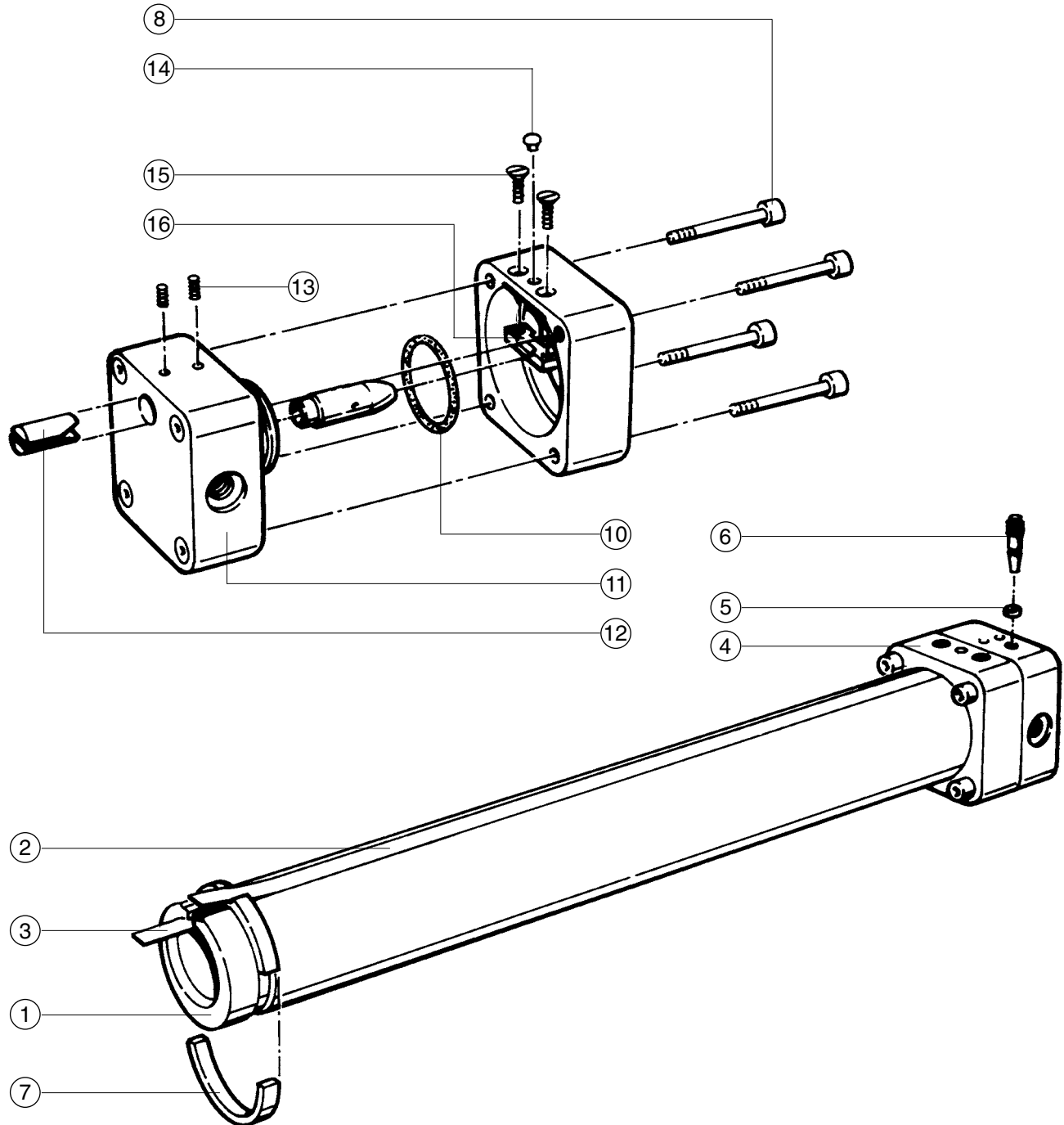

Spare Parts

Series P120 - Short Piston - Ø40mm - Ø80mm

Item	Description	40mm	63mm	80mm
20	Piston Seal (B)	1275	1345	1375
20.1	Piston Seal (V)	1276	1346	1376
21	Bearing Ring	1274	1344	1374
22	Cushion Seal (B)	1277	1347	1377
22.1	Cushion Seal (V)	1278	1348	1378
23	Screw - Yoke	1000-0612	1000-0816	1000-0818
24	Piston Axle (non-magnetic) S/	4843	6843	8843
24.1	Piston Axle (magnet 1 side) S/	N/A	6843	8843
25	Piston Axle (magnet 2 side) S/	4843	6843	8843
26	Nut - Piston Mount	1040-0600	1040-0800	1040-1000
27	Piston Yoke	1287	1356	1406
28	Bearing Strip	2798-0401	2798-0601	2798-0801
29	Screw - Piston Mount	1283	1000-0816	1000-1018
30	Screw - Piston Mount End	1038-0507	1038-0507	1038-0507
31	Scraper	1279	1349	1379
32	Piston Mount End Plate	1286	2040-0604	2040-0801
33	Piston Mount - S/20	1817	2503	2504
34	Piston Mount - S/22	2505	2507	2508
35	Piston Mount - S/25	2186-0404	2186-0604	2186-0802
36	Fork Bracket	1947	1955	1963
37	Carrier Pin	1948	1956	1964
38	O-Ring - Yoke (B)	1281	1351	1401
38.1	O-Ring - Yoke (V)	1282	1352	1402

(B) = Buna-N

(V) = Viton

Series P120 - Short Piston

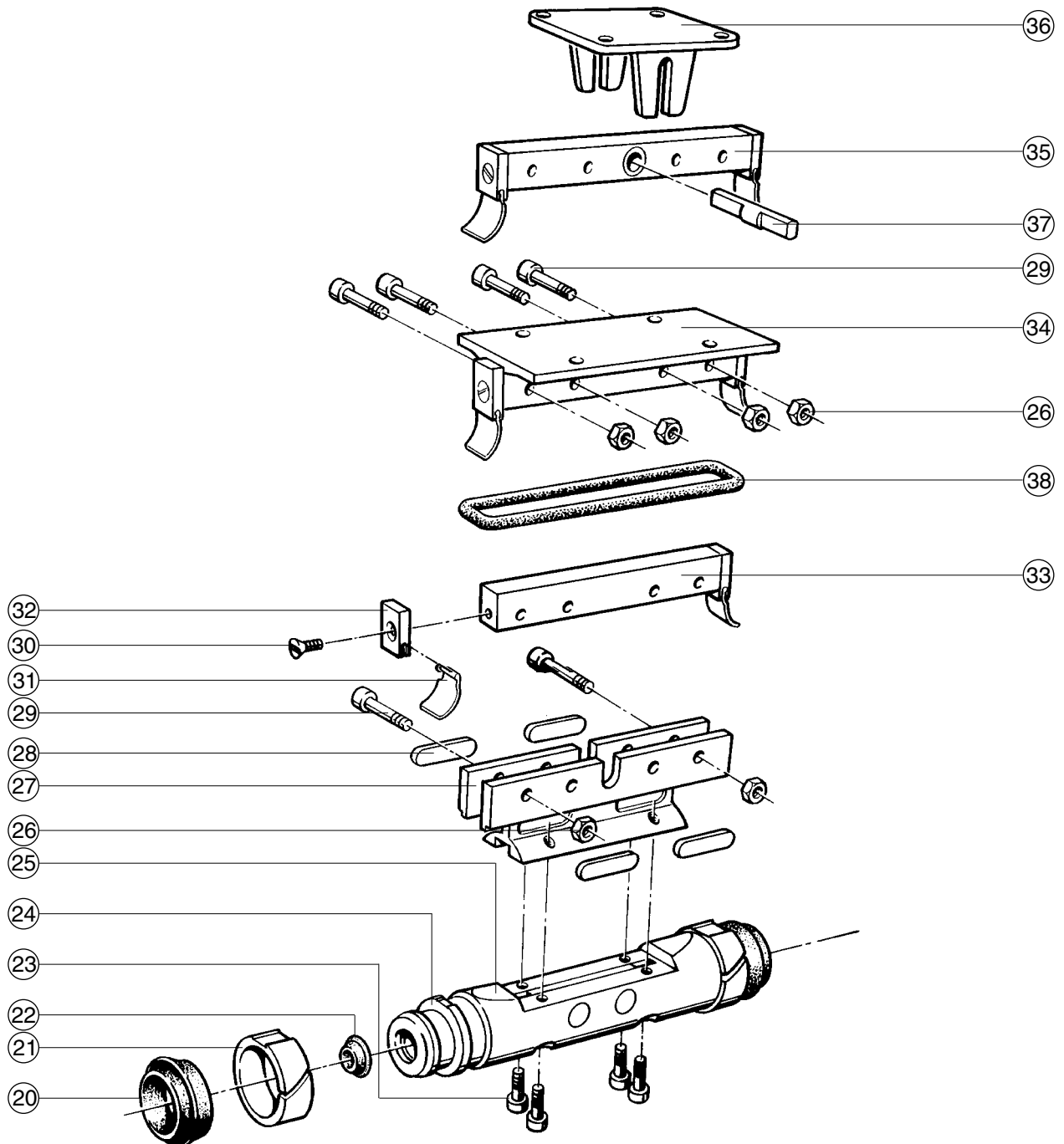

Spare Parts

Series P120 - Long Piston - Ø40mm - Ø80mm

Item	Description	40mm	63mm	80mm
20	Piston Seal (B)	1275	1345	1375
20.1	Piston Seal (V)	1276	1346	1376
21	Bearing Ring	1274	1344	1374
22	Cushion Seal (B)	1277	1347	1377
22.1	Cushion Seal (V)	1278	1349	1378
23	Screw - Yoke	1000-0612	1000-0816	1000-0818
26	Nut - Piston Mount	1040-0600	1040-0800	1040-1000
28	Bearing Strip	2798-0401	2798-0601	2798-0801
29	Screw - Piston Mount	1283	1000-0816	1000-1018
30	Screw - Piston Mount End	1038-0507	1038-0507	1038-0507
31	Scraper	1279	1349	1379
32	Piston Mount End	1286	2040-0604	2040-0801
40	Piston Axle (non-magnetic) L/	4844	6844	8844
40.1	Piston Axle (magnet 1 side) L/	N/A	6844	8844
41	Piston Axle (magnet 2 side) L/	4844	6844	8844
42	Piston Yoke	1298	1367	1417
43	Piston Mount - L/26	2492	2494	2495
44	Piston Mount - L/28	2496	2498	2499
45	O-Ring - Yoke (B)	1272-0526	1365	1272-0542
45.1	O-Ring - Yoke (V)	1297	1262-0538	1416

(B) = Buna-N

(V) = Viton

Series P120 - Long Piston

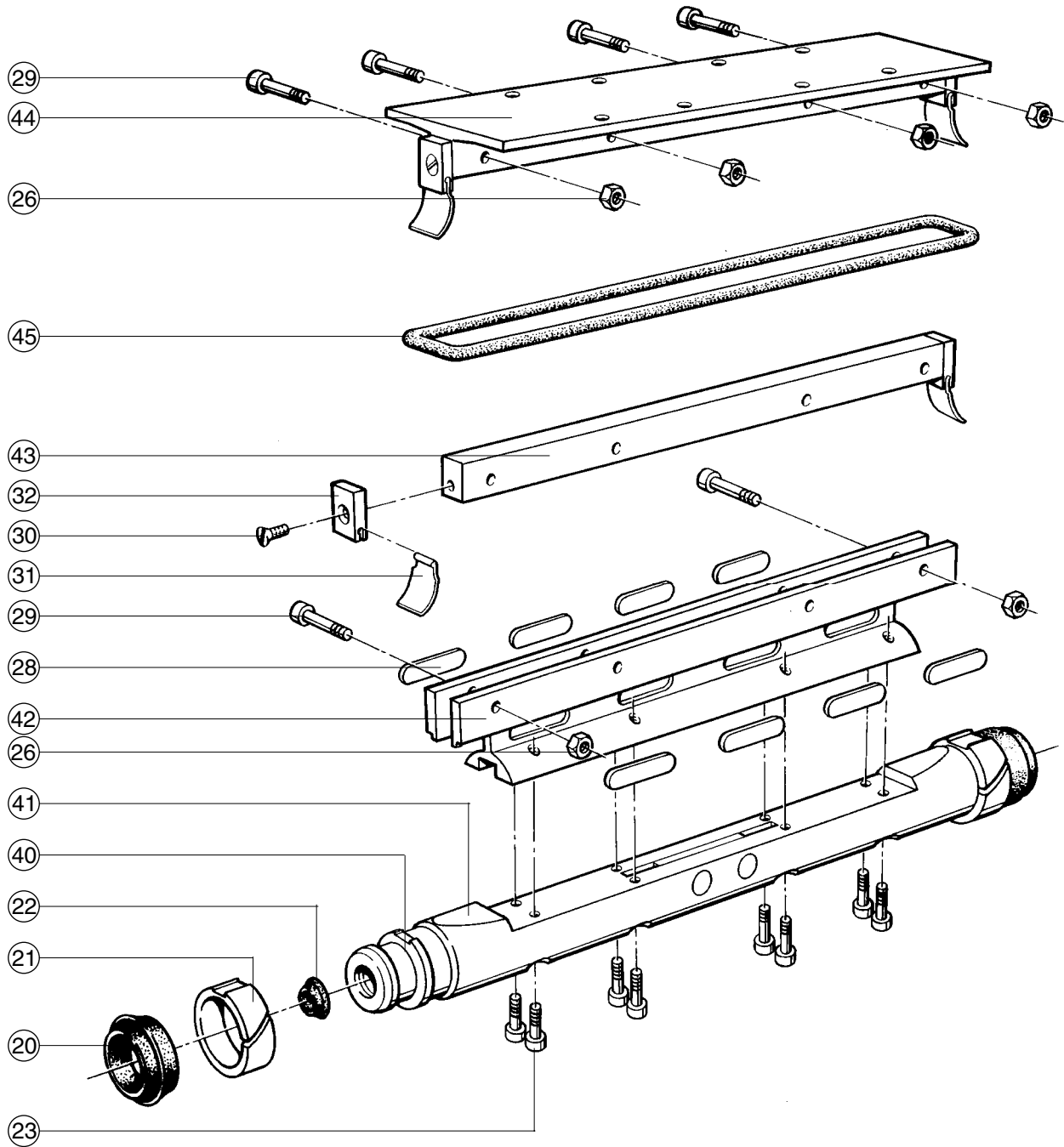

Spare Parts

Spare Parts Service Packs - Series 2002 / Series P120 - All bore sizes.

Designation Series 2002		Bore Sizes				
		16mm	25mm	32mm	40mm	50mm
Buna-N Service Pack Single Piston	Part Number	SP16-B-1	SP25R-B-1	SP32R-B-1	SP40R-B-1	SP50R-B-1
Viton Service Pack Single Piston	Part Number	SP16-V-1	SP25R-V-1	SP32R-V-1	SP40R-V-1	SP50R-V-1
Buna-N Service Pack Double Piston	Part Number	SP16-B-2	SP25R-B-2	SP32R-B-2	SP40R-B-2	SP50R-B-2
Viton Service Pack Double Piston	Part Number	SP16-V-2	SP25R-V-2	SP32R-V-2	SP40R-V-2	SP50R-V-2

Designation Series p120		Bore Sizes		
		40mm	60mm	80mm
Buna-N Service Pack Short Piston	Part Number	SP124-B-S	SP126-B-S	SP128-B-S
Viton Service Pack Short Piston	Part Number	SP124-V-S	SP126-V-S	SP128-V-S
Buna-N Service Pack Long Piston	Part Number	SP124-B-L	SP126-B-L	SP128-B-L
Viton Service Pack Long Piston	Part Number	SP124-V-L	SP126-V-L	SP128-V-L

Note: All Service Packs contain complete seal kits, inner and outer bands, cleaning tool, grease and repair instructions.

Upgrade Kit - required for cylinders manufactured prior to January 1, 2002

Designation Series 2002		Bore Sizes			
		25mm	32mm	40mm	50mm
Buna-N Upgrade Kit Single Piston	Part Number	25-UPGRADE-S-B	32-UPGRADE-S-B	40-UPGRADE-S-B	50-UPGRADE-S-B
Viton Upgrade Kit Single Piston	Part Number	25-UPGRADE-S-V	32-UPGRADE-S-V	40-UPGRADE-S-V	50-UPGRADE-S-V
Buna-N Upgrade Kit Double Piston	Part Number	25-UPGRADE-S-B-2	32-UPGRADE-S-B-2	40-UPGRADE-S-B-2	50-UPGRADE-S-B-2
Viton Upgrade Kit Double Piston	Part Number	25-UPGRADE-S-V-2	32-UPGRADE-S-V-2	40-UPGRADE-S-V-2	50-UPGRADE-S-V-2

Note: Upgrade kits include piston assembly, end cap assembly, piston mount assembly and complete service pack.

*S = Stroke

Notes



Safety Guide

Safety Guide for Selecting and Using Hydraulic, Pneumatic Cylinders and Their Accessories

WARNING: ⚠ **FAILURE OF THE CYLINDER, ITS PARTS, ITS MOUNTING, ITS CONNECTIONS TO OTHER OBJECTS, OR ITS CONTROLS CAN RESULT IN:**

- Unanticipated or uncontrolled movement of the cylinder or objects connected to it.
- Falling of the cylinder or objects held up by it.
- Fluid escaping from the cylinder, potentially at high velocity.

THESE EVENTS COULD CAUSE DEATH OR PERSONAL INJURY BY, FOR EXAMPLE, PERSONS FALLING FROM HIGH LOCATIONS, BEING CRUSHED OR STRUCK BY HEAVY OR FAST MOVING OBJECTS, BEING PUSHED INTO DANGEROUS EQUIPMENT OR SITUATIONS, OR SLIPPING ON ESCAPED FLUID.

Before selecting or using Parker (The Company) cylinders or related accessories, it is important that you read, understand and follow the following safety information. Training is advised before selecting and using The Company's products.

1.0 General Instructions

1.1 Scope – This safety guide provides instructions for selecting and using (including assembling, installing, and maintaining) cylinder products. This safety guide is a supplement to and is to be used with the specific Company publications for the specific cylinder products that are being considered for use.

1.2 Fail Safe – Cylinder products can and do fail without warning for many reasons. All systems and equipment should be designed in a fail-safe mode so that if the failure of a cylinder product occurs people and property won't be endangered.

1.3 Distribution – Provide a free copy of this safety guide to each person responsible for selecting or using cylinder products. Do not select or use The Company's cylinders without thoroughly reading and understanding this safety guide as well as the specific Company publications for the products considered or selected.

1.4 User Responsibility – Due to very wide variety of cylinder applications and cylinder operating conditions, The Company does not warrant that any particular cylinder is suitable for any specific application. This safety guide does not analyze all technical parameters that must be considered in selecting a product. The hydraulic and pneumatic cylinders outlined in this catalog are designed to The Company's design guidelines and do not necessarily meet the design guideline of other agencies such as American Bureau of Shipping, ASME Pressure Vessel Code etc. The user, through its own analysis and testing, is solely responsible for:

- Making the final selection of the cylinders and related accessories.
- Determining if the cylinders are required to meet specific design requirements as required by the Agency(s) or industry standards covering the design of the user's equipment.
- Assuring that the user's requirements are met, OSHA requirements are met, and safety guidelines from the applicable agencies such as but not limited to ANSI are followed and that the use presents no health or safety hazards.
- Providing all appropriate health and safety warnings on the equipment on which the cylinders are used.

1.5 Additional Questions – Call the appropriate Company technical service department if you have any questions or require any additional information. See the Company publication for the product being considered or used, or call 1-800-CPARKER, or go to www.parker.com, for telephone numbers of the appropriate technical service department.

2.0 Cylinder and Accessories Selection

2.1 Seals – Part of the process of selecting a cylinder is the selection of seal compounds. Before making this selection, consult the "seal information page(s)" of the publication for the series of cylinders of interest.

The application of cylinders may allow fluids such as cutting fluids, wash down fluids etc. to come in contact with the external area of the cylinder. These fluids may attack the piston rod wiper and or the primary seal and must be taken into account when selecting and specifying seal compounds.

Dynamic seals will wear. The rate of wear will depend on many operating factors. Wear can be rapid if a cylinder is mis-aligned or if the cylinder has been improperly serviced. The user must take seal wear into consideration in the application of cylinders.

2.2 Piston Rods – Possible consequences of piston rod failure or separation of the piston rod from the piston include, but are not limited to are:

- Piston rod and or attached load thrown off at high speed.
- High velocity fluid discharge.
- Piston rod extending when pressure is applied in the piston retract mode.

Piston rods or machine members attached to the piston rod may move suddenly and without warning as a consequence of other conditions occurring to the machine such as, but not limited to:

- Unexpected detachment of the machine member from the piston rod.
- Failure of the pressurized fluid delivery system (hoses, fittings, Rodless Cylinders, pumps, compressors) which maintain cylinder position.
- Catastrophic cylinder seal failure leading to sudden loss of pressurized fluid.
- Failure of the machine control system.

Follow the recommendations of the "Piston Rod Selection Chart and Data" in the publication for the series of cylinders of interest. The suggested piston rod diameter in these charts must be followed in order to avoid piston rod buckling.

Piston rods are not normally designed to absorb bending moments or loads which are perpendicular to the axis of piston rod motion. These additional loads can cause the piston rod to fail. If these types of additional loads are expected to be imposed on the piston rod, their magnitude should be made known to our engineering department.

The cylinder user should always make sure that the piston rod is securely attached to the machine member.

On occasion cylinders are ordered with double rods (a piston rod extended from both ends of the cylinder). In some cases a stop is threaded on to one of the piston rods and used as an external stroke adjuster. On occasions spacers are attached to the machine member connected to the piston rod and also used as a stroke adjuster. In both cases the stops will create a pinch point and the user should consider appropriate use of guards. If these external stops are not perpendicular to the mating contact surface, or if debris is trapped between the contact surfaces, a bending moment will be placed on the piston rod, which can lead to piston rod failure. An external stop will also negate the effect of cushioning and will subject the piston rod to impact loading. Those two (2) conditions can cause piston rod failure. Internal stroke adjusters are available with and without cushions. The use of external stroke adjusters should be reviewed with our engineering department.

The piston rod to piston and the stud to piston rod threaded connections are secured with an anaerobic adhesive. The strength of the adhesive decreases with increasing temperature. Cylinders which can be exposed to temperatures above +250°F (+121°C) are to be ordered with a non studded piston rod and a pinned piston to rod joint.

2.3 Cushions – Cushions should be considered for cylinder applications when the piston velocity is expected to be over 4 inches/second.

Cylinder cushions are normally designed to absorb the energy of a linear applied load. A rotating mass has considerably more energy than the same mass moving in a linear mode. Cushioning for a rotating mass application should be review by our engineering department.

2.4 Cylinder Mountings – Some cylinder mounting configurations may have certain limitations such as but not limited to minimum stroke for side or foot mounting cylinders or pressure de-ratings for certain mounts. Carefully review the catalog for these types of restrictions.

Always mount cylinders using the largest possible high tensile alloy steel socket head cap screws that can fit in the cylinder mounting holes and torque them to the manufacturer's recommendations for their size.

2.5 Port Fittings – Hydraulic cylinders applied with meter out or deceleration circuits are subject to intensified pressure at piston rod end.

The rod end pressure is approximately equal to:

$$\frac{\text{operating pressure} \times \text{effective cap end area}}{\text{effective rod end piston area}}$$

Contact your connector supplier for the pressure rating of individual connectors.

3.0 Cylinder and Accessories Installation and Mounting

3.1 Installation

3.1.1 – Cleanliness is an important consideration, and cylinders are shipped with the ports plugged to protect them from contaminants entering the ports. These plugs should not be removed until the piping is to be installed. Before making the connection to the cylinder ports, piping should be thoroughly cleaned to remove all chips or burrs which might have resulted from threading or flaring operations.



Safety Guide

3.1.2 – Cylinders operating in an environment where air drying materials are present such as fast-drying chemicals, paint, or weld splatter, or other hazardous conditions such as excessive heat, should have shields installed to prevent damage to the piston rod and piston rod seals.

3.1.3 – Proper alignment of the cylinder piston rod and its mating component on the machine should be checked in both the extended and retracted positions. Improper alignment will result in excessive rod gland and/or cylinder bore wear. On fixed mounting cylinders attaching the piston rod while the rod is retracted will help in achieving proper alignment.

3.1.4 – Sometimes it may be necessary to rotate the piston rod in order to thread the piston rod into the machine member. This operation must always be done with zero pressure being applied to either side of the piston. Failure to follow this procedure may result in loosening the piston to rod-threaded connection. In some rare cases the turning of the piston rod may rotate a threaded piston rod gland and loosen it from the cylinder head. Confirm that this condition is not occurring. If it does, re-tighten the piston rod gland firmly against the cylinder head.

For double rod cylinders it is also important that when attaching or detaching the piston rod from the machine member that the torque be applied to the piston rod end of the cylinder that is directly attaching to the machine member with the opposite end unrestrained. If the design of the machine is such that only the rod end of the cylinder opposite to where the rod attaches to the machine member can be rotated, consult the factory for further instructions.

3.2 Mounting Recommendations

3.2.1 – Always mount cylinders using the largest possible high tensile alloy steel socket head screws that can fit in the cylinder mounting holes and torque them to the manufacturer's recommendations for their size.

3.2.2 – Side-Mounted Cylinders – In addition to the mounting bolts, cylinders of this type should be equipped with thrust keys or dowel pins located so as to resist the major load.

3.2.3 – Tie Rod Mounting – Cylinders with tie rod mountings are recommended for applications where mounting space is limited. The standard tie rod extension is shown as BB in dimension tables. Longer or shorter extensions can be supplied. Nuts used for this mounting style should be torqued to the same value as the tie rods for that bore size.

3.2.4 – Flange Mount Cylinders – The controlled diameter of the rod gland extension on head end flange mount cylinders can be used as a pilot to locate the cylinders in relation to the machine. After alignment has been obtained, the flanges may be drilled for pins or dowels to prevent shifting.

3.2.5 – Trunnion Mountings – Cylinders require lubricated bearing blocks with minimum bearing clearances. Bearing blocks should be carefully aligned and rigidly mounted so the trunnions will not be subjected to bending moments. The rod end should also be pivoted with the pivot pin in line and parallel to axis of the trunnion pins.

3.2.6 – Clevis Mountings – Cylinders should be pivoted at both ends with centerline of pins parallel to each other. After cylinder is mounted, be sure to check to assure that the cylinder is free to swing through its working arc without interference from other machine parts.

4.0 Cylinder and Accessories Maintenance, Troubleshooting and Replacement

4.1 Storage – At times cylinders are delivered before a customer is ready to install them and must be stored for a period of time. When storage is required the following procedures are recommended.

4.1.1 – Store the cylinders in an indoor area which has a dry, clean and noncorrosive atmosphere. Take care to protect the cylinder from both internal corrosion and external damage.

4.1.2 – Whenever possible cylinders should be stored in a vertical position (piston rod up). This will minimize corrosion due to possible condensation which could occur inside the cylinder. This will also minimize seal damage.

4.1.3 – Port protector plugs should be left in the cylinder until the time of installation.

4.1.4 – If a cylinder is stored full of hydraulic fluid, expansion of the fluid due to temperature changes must be considered. Installing a check valve with free flow out of the cylinder is one method.

4.1.5 – When cylinders are mounted on equipment that is stored outside for extended periods, exposed unpainted surfaces, e.g. piston rod, must be coated with a rust-inhibiting compound to prevent corrosion.

4.2 Cylinder Trouble Shooting

4.2.1 – External Leakage

4.2.1.1 – Rod seal leakage can generally be traced to worn or damaged seals. Examine the piston rod for dents, gouges or score marks, and replace piston rod if surface is rough.

Rod seal leakage could also be traced to gland wear. If clearance is excessive, replace rod bushing and seal. Rod seal leakage can also be traced to seal deterioration. If seals are soft or gummy or brittle, check compatibility of seal material with lubricant used if air cylinder, or operating fluid if hydraulic cylinder. Replace with seal material, which is compatible with these fluids. If the seals are hard or have lost elasticity, it is usually due to exposure to temperatures in excess of 165°F. (+74°C). Shield the cylinder from the heat source to limit temperature to 350°F. (+177°C.) and replace with fluorocarbon seals.

4.2.1.2 – Cylinder body seal leak can generally be traced to loose tie rods. Torque the tie rods to manufacturer's recommendation for that bore size.

Excessive pressure can also result in cylinder body seal leak. Determine maximum pressure to rated limits. Replace seals and retorque tie rods as in paragraph above. Excessive pressure can also result in cylinder body seal leak. Determine if the pressure rating of the cylinder has been exceeded. If so, bring the operating pressure down to the rating of the cylinder and have the tie rods replaced.

Pinched or extruded cylinder body seal will also result in a leak. Replace cylinder body seal and retorque as in paragraph above.

Cylinder body seal leakage due to loss of radial squeeze which shows up in the form of flat spots or due to wear on the O.D. or I.D. – Either of these are symptoms of normal wear due to high cycle rate or length of service. Replace seals as per paragraph above.

4.2.2 – Internal Leakage

4.2.2.1 – Piston seal leak (by-pass) 1 to 3 cubic inches per minute leakage is considered normal for piston ring construction. Virtually no static leak with lipseal type seals on piston should be expected. Piston seal wear is a usual cause of piston seal leakage. Replace seals as required.

4.2.2.2 – With lipseal type piston seals excessive back pressure due to over-adjustment of speed control Rodless Cylinders could be a direct cause of rapid seal wear. Contamination in a hydraulic system can result in a scored cylinder bore, resulting in rapid seal wear. In either case, replace piston seals as required.

4.2.2.3 – What appears to be piston seal leak, evidenced by the fact that the cylinder drifts, is not always traceable to the piston. To make sure, it is suggested that one side of the cylinder piston be pressurized and the fluid line at the opposite port be disconnected. Observe leakage. If none is evident, seek the cause of cylinder drift in other component parts in the circuit.

4.2.3 – Cylinder Fails to Move the Load

4.2.3.1 – Pneumatic or hydraulic pressure is too low. Check the pressure at the cylinder to make sure it is to circuit requirements.

4.2.3.2 – Piston Seal Leak – Operate the valve to cycle the cylinder and observe fluid flow at valve exhaust ports at end of cylinder stroke. Replace piston seals if flow is excessive.

4.2.3.3 – Cylinder is undersized for the load – Replace cylinder with one of a larger bore size.

4.3 Erratic or Chatter Operation

4.3.1 – Excessive friction at rod gland or piston bearing due to load misalignment – Correct cylinder-to-load alignment.

4.3.2 – Cylinder sized too close to load requirements – Reduce load or install larger cylinder.

4.3.3 – Erratic operation could be traced to the difference between static and kinetic friction. Install speed control Rodless Cylinders to provide a back pressure to control the stroke.

4.4 Cylinder Modifications, Repairs, or Failed Component – Cylinders as shipped from the factory are not to be disassembled and or modified. If cylinders require modifications, these modifications must be done at company locations or by The Company's certified facilities. The Cylinder Division Engineering Department must be notified in the event of a mechanical fracture or permanent deformation of any cylinder component (excluding seals). This includes a broken piston rod, tie rod, mounting accessory or any other cylinder component. The notification should include all operation and application details. This information will be used to provide an engineered repair that will prevent recurrence of the failure.

It is allowed to disassemble cylinders for the purpose of replacing seals or seal assemblies. However, this work must be done by strictly following all the instructions provided with the seal kits.

Offer of Sale

Offer of Sale

The items described in this document and other documents or descriptions provided by Parker Hannifin Corporation, its subsidiaries and Divisions ("Company") and its authorized distributors, are hereby offered for sale at prices to be established by the Company, its subsidiaries and its authorized distributors. This offer and its acceptance by any customer ("Buyer") shall be governed by all of the following Terms and Conditions. Buyer's order for any such item, when communicated to the Company, its subsidiary or an authorized distributor ("Seller") verbally or in writing, shall constitute acceptance of this offer.

1. Terms and Conditions of Sale: All descriptions, quotations, proposals, offers, acknowledgments, acceptances and sales of Seller's products are subject to and shall be governed exclusively by the terms and conditions stated herein. Buyer's acceptance of any offer to sell is limited to these terms and conditions. Any terms or conditions in addition to, or inconsistent with those stated herein, proposed by Buyer in any acceptance of an offer by Seller, are hereby objected to. No such additional, different or inconsistent terms and conditions shall become part of the contract between Buyer and Seller unless expressly accepted in writing by Seller. Seller's acceptance of any offer to purchase by Buyer is expressly conditional upon Buyer's assent to all the terms and conditions stated herein, including any terms in addition to, or inconsistent with those contained in Buyer's offer. Acceptance of Seller's products shall in all events constitute such assent.

2. Payment: Payment shall be made by Buyer net 30 days from the date of delivery of the items purchased hereunder. Amounts not timely paid shall bear interest at the maximum rate permitted by law for each month or portion thereof that the Buyer is late in making payment. Any claims by Buyer for omissions or shortages in a shipment shall be waived unless Seller receives notice thereof within 30 days after Buyer's receipt of the shipment.

3. Delivery: Unless otherwise provided on the face hereof, delivery shall be made F.O.B. Seller's plant. Regardless of the method of delivery, however, risk of loss shall pass to Buyer upon Seller's delivery to a carrier. Any delivery dates shown are approximate only and Seller shall have no liability for any delays in delivery.

4. Warranty: Seller warrants that the items sold hereunder shall be free from defects in material or workmanship for a period of 18 months from date of shipment from the Company. **THIS WARRANTY COMPRISES THE SOLE AND ENTIRE WARRANTY PERTAINING TO ITEMS PROVIDED HEREUNDER. SELLER MAKES NO OTHER WARRANTY, GUARANTEE, OR REPRESENTATION OF ANY KIND WHATSOEVER. ALL OTHER WARRANTIES, INCLUDING BUT NOT LIMITED TO, MERCHANTABILITY AND FITNESS FOR PURPOSE, WHETHER EXPRESS, IMPLIED, OR ARISING BY OPERATION OF LAW, TRADE USAGE, OR COURSE OF DEALING ARE HEREBY DISCLAIMED.**

NOTWITHSTANDING THE FOREGOING, THERE ARE NOWARRANTIES WHATSOEVER ON ITEMS BUILT OR ACQUIRED WHOLLY OR PARTIALLY, TO BUYER'S DESIGN OR SPECIFICATIONS.

5. Limitation of Remedy: SELLER'S LIABILITY ARISING FROM OR IN ANY WAY CONNECTED WITH THE ITEMS SOLD OR THIS CONTRACT SHALL BE LIMITED EXCLUSIVELY TO REPAIR OR REPLACEMENT OF THE ITEMS SOLD OR REFUND OF THE PURCHASE PRICE PAID BY BUYER, AT SELLER'S SOLE OPTION. IN NO EVENT SHALL SELLER BE LIABLE FOR ANY INCIDENTAL, CONSEQUENTIAL OR SPECIAL DAMAGES OF ANY KIND OR NATURE WHATSOEVER, INCLUDING BUT NOT LIMITED TO LOST PROFITS ARISING FROM OR IN ANY WAY CONNECTED WITH THIS AGREEMENT OR ITEMS SOLD HEREUNDER, WHETHER ALLEGED TO ARISE FROM BREACH OF CONTRACT, EXPRESS OR IMPLIED WARRANTY, OR IN TORT, INCLUDING WITHOUT LIMITATION, NEGLIGENCE, FAILURE TO WARN OR STRICT LIABILITY.

6. Changes, Reschedules and Cancellations: Buyer may request to modify the designs or specifications for the items sold hereunder as well as the quantities and delivery dates thereof, or may request to cancel all or part of this order, however, no such requested modification or cancellation shall become part of the contract between Buyer and Seller unless accepted by Seller in a written amendment to this Agreement. Acceptance of any such requested modification or cancellation shall be at Seller's discretion, and shall be upon such terms and conditions as Seller may require.

7. Special Tooling: A tooling charge may be imposed for any special tooling, including without limitations, dies, fixtures, molds and patterns, acquired to manufacture items sold pursuant to this contract. Such special tooling shall be and remain Seller's property notwithstanding payment of any charges by Buyer. In no event will Buyer acquire any interest in apparatus belonging to Seller which is utilized in the manufacture of the items sold hereunder, even if such apparatus has been specially converted or adapted for such manufacture and notwithstanding any charges paid by Buyer. Unless otherwise agreed, Seller shall have the right to alter,

discard or otherwise dispose of any special tooling or other property in its sole discretion at any time.

8. Buyer's Property: Any designs, tools, patterns, materials, drawings, confidential information or equipment furnished by Buyer, or any other items which become Buyer's property, may be considered obsolete and may be destroyed by Seller after two (2) consecutive years have elapsed without Buyer placing an order for the items which are manufactured using such property. Seller shall not be responsible for any loss or damage to such property while it is in Seller's possession or control.

9. Taxes: Unless otherwise indicated on the face hereof, all prices and charges are exclusive of excise, sales, use, property, occupational or like taxes which may be imposed by any taxing authority upon the manufacture, sale or delivery of the items sold hereunder. If any such taxes must be paid by Seller or if Seller is liable for the collection of such tax, the amount thereof shall be in addition to the amounts for the items sold. Buyer agrees to pay all such taxes or to reimburse Seller therefore upon receipt of its invoice. If Buyer claims exemption from any sales, use or other tax imposed by any taxing authority, Buyer shall save Seller harmless from and against any such tax, together with any interest or penalties thereon which may be assessed if the items are held to be taxable.

10. Indemnity For Infringement of Intellectual Property Rights: Seller shall have no liability for infringement of any patents, trademarks, copyrights, trade dress, trade secrets or similar rights except as provided in this Part 10. Seller will defend and indemnify Buyer against allegations of infringement of U.S. patents, U.S. trademarks, copyrights, trade dress and trade secrets (hereinafter "Intellectual Property Rights"). Seller will defend at its expense and will pay the cost of any settlement or damages awarded in an action brought against Buyer based on an allegation that an item sold pursuant to this contract infringes the Intellectual Property Rights of a third party. Seller's obligation to defend and indemnify Buyer is contingent on Buyer notifying Seller within ten (10) days after Buyer becomes aware of such allegations of infringement, and Seller having sole control over the defense of any allegations or actions including all negotiations for settlement or compromise. If an item sold hereunder is subject to a claim that it infringes the Intellectual Property Rights of a third party, Seller may, at its sole expense and option, procure for Buyer the right to continue using said item, replace or modify said item so as to make it noninfringing, or offer to accept return of said item and return the purchase price less a reasonable allowance for depreciation. Notwithstanding the foregoing, Seller shall have no liability for claims of infringement based on information provided by Buyer, or directed to items delivered hereunder for which the designs are specified in whole or part by Buyer, or infringements resulting from the modification, combination or use in a system of any item sold hereunder. The foregoing provisions of this Part 10 shall constitute Seller's sole and exclusive liability and Buyer's sole and exclusive remedy for infringement of Intellectual Property Rights.

If a claim is based on information provided by Buyer or if the design for an item delivered hereunder is specified in whole or in part by Buyer, Buyer shall defend and indemnify Seller for all costs, expenses or judgements resulting from any claim that such item infringes any patent, trademark, copyright, trade dress, trade secret or any similar right.

11. Force Majeure: Seller does not assume the risk of and shall not be liable for delay or failure to perform any of Seller's obligations by reason of circumstances beyond the reasonable control of Seller (hereinafter "Events of Force Majeure"). Events of Force Majeure shall include without limitation, accidents, acts of God, strikes or labor disputes, acts, laws, rules or regulations of any government or government agency, fires, floods, delays or failures in delivery of carriers or suppliers, shortages of materials and any other cause beyond Seller's control.

12. Entire Agreement/Governing Law: The terms and conditions set forth herein, together with any amendments, modifications and any different terms or conditions expressly accepted by Seller in writing, shall constitute the entire Agreement concerning the items sold, and there are no oral or other representations or agreements which pertain thereto. This Agreement shall be governed in all respects by the law of the State of Ohio. No actions arising out of sale of the items sold hereunder or this Agreement may be brought by either party more than two (2) years after the cause of action accrues.



Parker Hannifin Corporation
Parker-Origa
100 West Lake Drive
Glendale Heights, IL 60139 USA

Phone 630-871-8300
fax 630-871-1515
toll free 800-695-5984
email: info-hous-market@parker.com
website www.parkeroriga.com

