

## SERIES 100

Current output, 2 wire

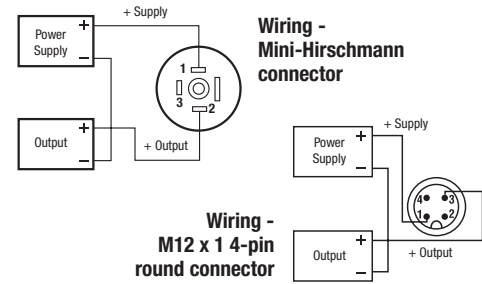

### Load Limitations 4 mA to 20 mA Output Only

$$V_{min} = 10V + (.020 \times R_L)$$

$$R_L = R_s + R_w$$

$R_L$  = Loop Resistance (ohms)  
 $R_s$  = Sense Resistance (ohms)  
 $R_w$  = Wire Resistance (ohms)

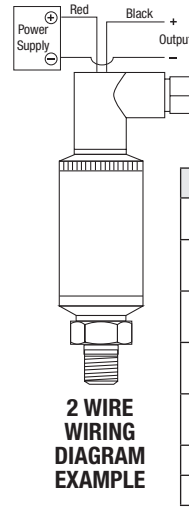

Series 100		4 mA to 20 mA	
CONNECTION TYPE (CODE)	+ SUPPLY	+ OUTPUT	
Mini-Hirschmann (7)	1	2	
Mini-Hirschmann w/ Cable (1)	Red	Black	
4 or 6 Pin Bendix (2 or 3)	A	B	
1/2" NPT Conduit w/ Cable (6)	Red	Black	
M12 x 1, 4-Pin (25)	1	3	
Integral Cable (36)	Red	Black	

## SERIES 200

Voltage output, 3 wire

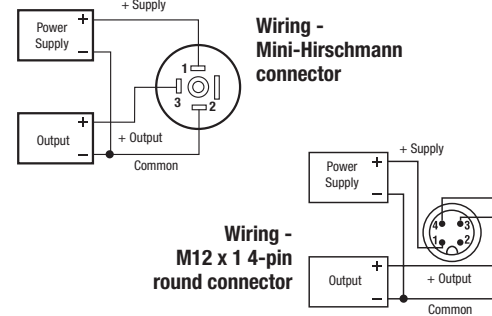

### 3 WIRE WIRING DIAGRAM EXAMPLE

Series 200		0-5 Vdc, 1-5 Vdc, 1-6 Vdc, 0-10 Vdc, 1-11 Vdc		
CONNECTION TYPE (CODE)	+ SUPPLY	COMMON	+ OUTPUT	
Mini-Hirschmann (7)	1	2	3	
Mini-Hirschmann w/ Cable (1)	Red	Black	White	
4 or 6 Pin Bendix (2 or 3)	A	B	C	
1/2" NPT Conduit w/ Cable (6)	Red	Black	White	
M12 x 1, 4-Pin (25)	1	3	4	
Integral Cable (36)	Red	Black	White	

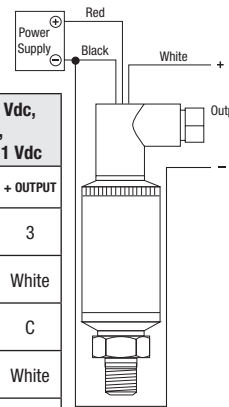

## SERIES 300

### 2 WIRE WIRING DIAGRAM EXAMPLE

Series 300		4 mA to 20 mA	
CONNECTION TYPE (CODE)	+ SUPPLY	+ OUTPUT	
Hirschmann (7, 8 or 14)	1	2	
Hirschmann w/ Cable (1)	Red	Black	
M12 x 1, 4-Pin (25)	1	3	
Integral Cable (36)	Brown	Blue	

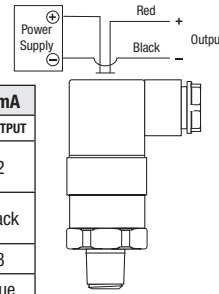

### Load Limitations 4 mA to 20 mA Output Only

$$V_{min} = 10V + (.020 \times R_L)$$

$$R_L = R_s + R_w$$

$R_L$  = Loop Resistance (ohms)  
 $R_s$  = Sense Resistance (ohms)  
 $R_w$  = Wire Resistance (ohms)

### 3 WIRE WIRING DIAGRAM EXAMPLE

Series 300		0-5 Vdc, 1-5 Vdc, 1-6 Vdc, 0-10 Vdc, 1-11 Vdc		
CONNECTION TYPE (CODE)	+ SUPPLY	COMMON	+ OUTPUT	
Hirschmann (7, 8 or 14)	1	2	3	
Hirschmann w/ Cable (1)	Red	Black	White	
M12 x 1, 4-Pin (25)	1	3	4	
Integral Cable (36)	Brown	Blue	Black	

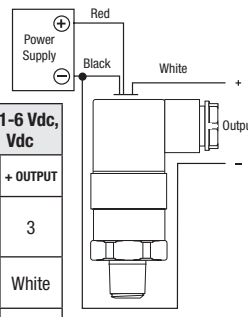

## SERIES 612 & 613

### 2 WIRE WIRING DIAGRAM EXAMPLE

Series 612/613		4 mA to 20 mA		
CONNECTION TYPE	+ SUPPLY	+ OUTPUT	CASE GROUND	
Cable	Red	Black	Shield	

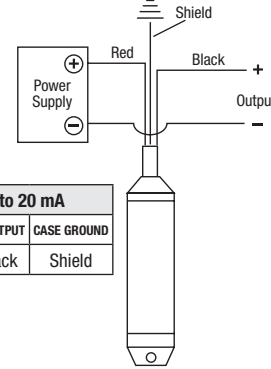

### Load Limitations 4 mA to 20 mA Output Only

$$V_{min} = [10V + (.020 \times R_L)] - 0.04354 \frac{\rho}{\pi r^2} \times \text{cable length}$$

$R_L$  =  $R_s + R_w$   
 $R_L$  = Loop Resistance (ohms)  
 $R_s$  = Sense Resistance (ohms)  
 $R_w$  = Wire Resistance (ohms)

### 3 WIRE WIRING DIAGRAM EXAMPLE

Series 612/613		0-5 Vdc, 0-10 Vdc, 0.5 to 2.5 Vdc			
CONNECTION TYPE	+ SUPPLY	COMMON	+ OUTPUT	CASE GROUND	
Cable	Red	Black	White	Shield	

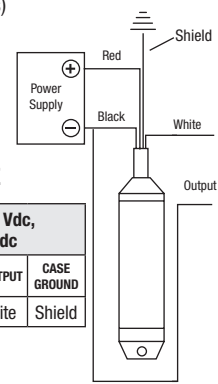

## SERIES 615/616

### 2 WIRE WIRING DIAGRAM EXAMPLE

Series 615/616		4 mA to 20 mA	
CONNECTION TYPE (CODE)	+ SUPPLY	+ OUTPUT	
Hirschmann (8 or 14)	1	2	
Hirschmann w/ Cable (1)	Red	Black	
6 Pin Bendix (3)	A	B	
1/2" NPT Conduit w/ Cable (6)	Red	Black	
M12 x 1, 4-Pin (25)	1	3	
Integral Cable (36)	Red	Black	

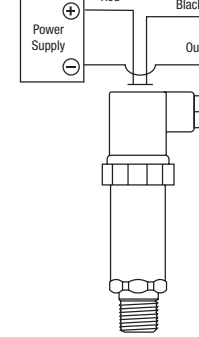

### Load Limitations 4 mA to 20 mA Output Only

$$V_{min} = 10V + (.020 \times R_L)$$

$$R_L = R_s + R_w$$

$R_L$  = Loop Resistance (ohms)  
 $R_s$  = Sense Resistance (ohms)  
 $R_w$  = Wire Resistance (ohms)

### 3 WIRE WIRING DIAGRAM EXAMPLE

Series 615/616		0-5 Vdc, 1-5 Vdc, 1-6 Vdc, 0-10 Vdc, 1-11 Vdc		
CONNECTION TYPE (CODE)	+ SUPPLY	COMMON	+ OUTPUT	
Hirschmann (8 or 14)	1	2	3	
Hirschmann w/ Cable (1)	Red	Black	White	
6 Pin Bendix (3)	A	B	C	
1/2" NPT Conduit w/ Cable (6)	Red	Black	White	
M12 x 1, 4-Pin (25)	1	3	4	
Integral Cable (36)	Red	Black	White	

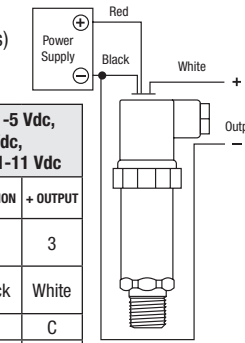

## SERIES 640

Current output, 2 wire

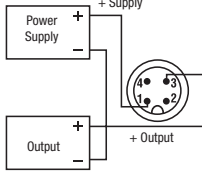

Voltage output, 3 wire

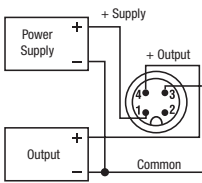

### Wiring - M12 x 1 4-pin round connector

Series 640		4 mA to 20 mA	
CONNECTION TYPE (CODE)	+ SUPPLY	+ OUTPUT	
Hirschmann (8 or 14)	1	2	
Hirschmann w/ Cable (1)	Red	Black	
6 Pin Bendix (3)	A	B	
M12 x 1, 4-Pin (25)	1	3	
Integral Cable (36)	Brown	Blue	

### Load Limitations 4 mA to 20 mA Output Only

$$V_{min} = 10V + (.020 \times R_L)$$

$$R_L = R_s + R_w$$

$R_L$  = Loop Resistance (ohms)  
 $R_s$  = Sense Resistance (ohms)  
 $R_w$  = Wire Resistance (ohms)

### RS 232 Interface

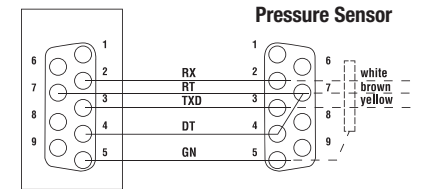

### Pressure Sensor

Series 640		0-5 Vdc, 0-10 Vdc, 0-20 mA		
CONNECTION TYPE (CODE)	+ SUPPLY	COMMON	+ OUTPUT	
Hirschmann (8 or 14)	1	2	3	
Hirschmann w/ Cable (1)	Red	Black	White	
6 Pin Bendix (3)	A	B	C	
M12 x 1, 4-Pin (25)	1	3	4	
Integral Cable (36)	Brown	Black	Blue	

## SERIES 660

### Wiring - Mini-Hirschmann connector

Current output, 2 wire

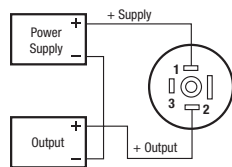

Voltage output, 3 wire

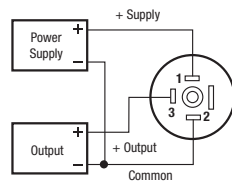

#### Load Limitations

**4 mA to 20 mA Output Only**  
 $V_{min} = 10V + (.020 \times R_L)$   
 $R_L = R_s + R_w$   
 $R_L$  = Loop Resistance (ohms)  
 $R_s$  = Sense Resistance (ohms)  
 $R_w$  = Wire Resistance (ohms)

Series 660	4 mA to 20 mA	
CONNECTION TYPE (CODE)	+ SUPPLY	+ OUTPUT
Mini-Hirschmann (7)	1	2
Mini-Hirschmann w/ Cable (1)	Red	Black
M12 x 1, 4-Pin (25)	1	3
Integral Cable (36)	Brown	Green

### Wiring - M12 x 1 4-pin round connector

Current output, 2 wire

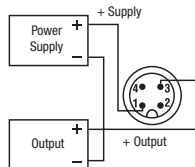

Voltage output, 3 wire

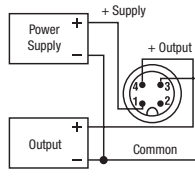

Series 660	1-5 Vdc, 0.1-10 Vdc		
CONNECTION TYPE (CODE)	+ SUPPLY	COMMON	+ OUTPUT
Mini-Hirschmann (7)	1	2	3
Mini-Hirschmann w/ Cable (1)	Red	Black	White
M12 x 1, 4-Pin (25)	1	3	4
Integral Cable (36)	Brown	Green	White

## SERIES 800

4 mA to 20 mA, 2 wire

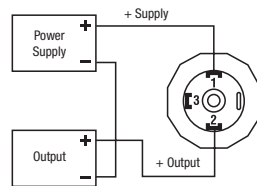

#### Load Limitations

**4 mA to 20 mA Output Only**  
 $V_{min} = 10V + (.020 \times R_L)$   
 $R_L = R_s + R_w$   
 $R_L$  = Loop Resistance (ohms)  
 $R_s$  = Sense Resistance (ohms)  
 $R_w$  = Wire Resistance (ohms)

Series 800	4 mA to 20 mA	
CONNECTION TYPE (CODE)	+ SUPPLY	+ OUTPUT
Hirschmann (8 or 14)	1	2
Hirschmann w/ Cable (1)	Red	Black
M12 x 1, 4-Pin (25)	1	3

0 Vdc to 10 Vdc, 3 wire

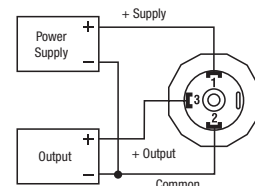

Series 800	0-10 Vdc		
CONNECTION TYPE (CODE)	+ SUPPLY	COMMON	+ OUTPUT
Hirschmann (8 or 14)	1	2	3
Hirschmann w/ Cable (1)	Red	Black	White
M12 x 1, 4-Pin (25)	1	3	4

### Installation:

NOSHOK pressure transmitters/transducers may be mounted in any plane with negligible effect on performance. Although these units are designed and manufactured to withstand substantial shock and vibration, it is recommended that they be mounted in an area of minimal vibration. Always use a wrench on the wrench flats when installing. NEVER use a pipe wrench on the housing or in the area of the electrical connection.

### Maintenance/Calibration:

NOSHOK pressure transmitters/transducers require no maintenance. Recalibration is dependent on the users Quality Assurance Program. If no program is in place, NOSHOK recommends a 1 year cycle.

### Alignment Procedure (applies only to 100, 200, 615/616, and 640 series):

Using a pressure source and meter with adequate accuracy, perform the following steps:

- Open sensor
- With no pressure applied, adjust the "Z" potentiometer for the correct Zero output
- Apply the correct full scale pressure to the unit
- Adjust the "S" potentiometer for the correct Span output

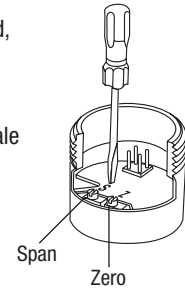

# NOSHOK TRANSMITTERS TRANSducers

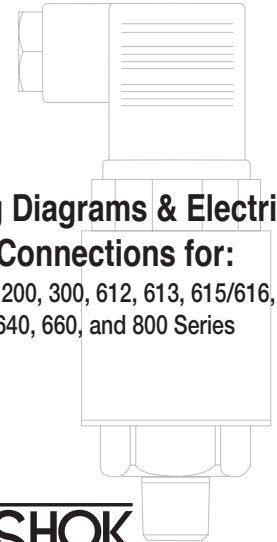

## Wiring Diagrams & Electrical Connections for:

100, 200, 300, 612, 613, 615/616, 640, 660, and 800 Series

# NOSHOK

**CORPORATE HEADQUARTERS**  
 1010 West Bagley Rd. • Berea, OH 44017  
 440.243.0888 • FAX 440.243.3472  
 E-mail: noshok@noshok.com  
 Web: www.noshok.com