

## Adapters

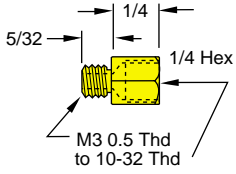

87 M3 to 10-32 (F)

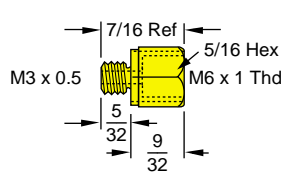

M3 to M6 (F)

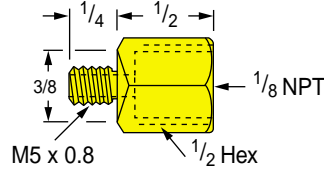

M5 to 1/8 (F)

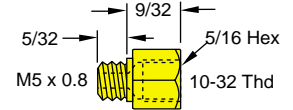

M5 to 10-32 (F)

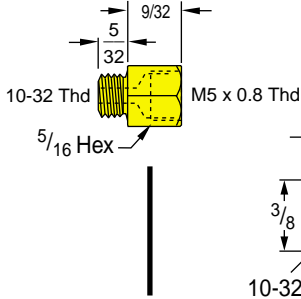

88 10-32 to M5 (F)

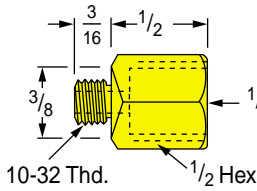

10-32 to 1/8 (F)

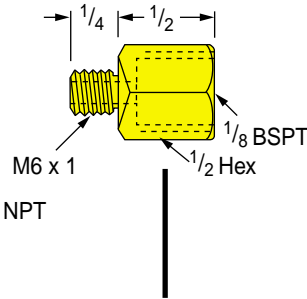

M6 to 1/8 BSPT (F)

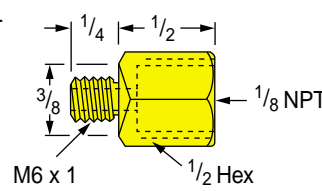

M6 to 1/8 (F)

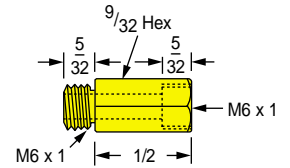

EX-M6 (M-F)

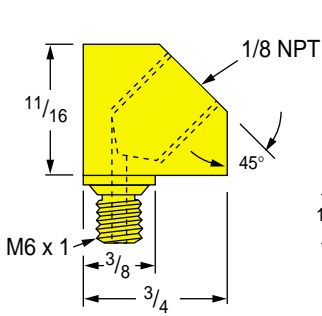

89 M6 to 1/8 (F) 45°

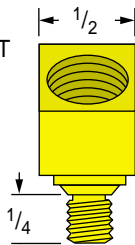

M8 to 10-32 (F)

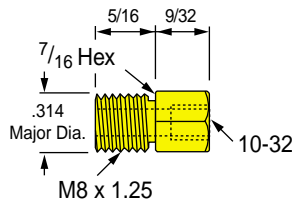

M8 to 1/8 (F)

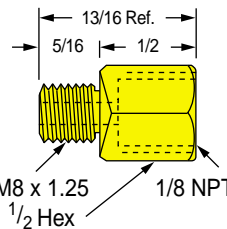

M8 to 1/8-28 BSPP (F)

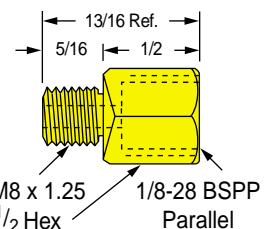

90 AN 1/8 to 10-32

AN 1/8 to M5

1/4 BSPT to 1/8 (F)

1/4 BSPT to 1/4 (F)

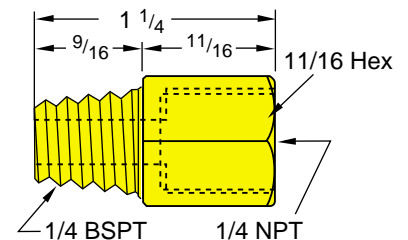
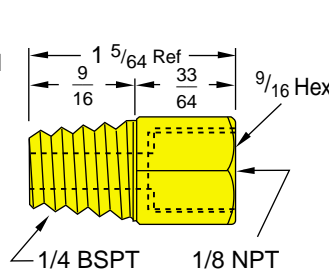
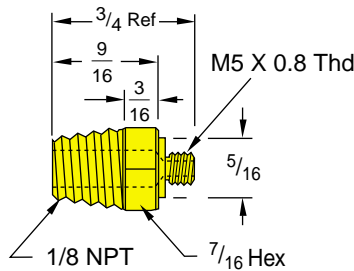
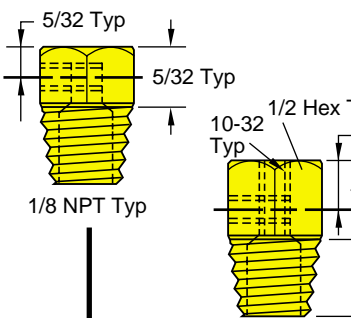

91 1/8L-10F

1/8LT-10F

1/8T-10F

1/8T-10F x 3

1/4L-10F

1/4LT-10F

1/4T-10F

1/4T-10F x 3

90° L Adapters – Male to Female

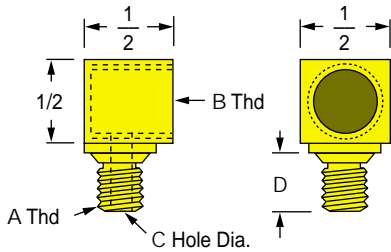

Part No.	A Thd	B Thd	C Dia	D	Line No.
M8 to 1/8FL	M8x1.25	1/8 NPT			92
M8 to M8FL	M8x1.25	M8x1.25			93
M8 to M6FL	M8x1.25	M6x1			94
M8 to M5FL	M8x1.25	M5x0.8	5/32	5/16	95
M8 to M3FL	M8x1.25	M3x0.5			96
M8 to 1/4-28FL	M8x1.25	1/4-28			97
M8 to 10-32FL	M8x1.25	10-32			98
M6 to 1/8FL	M6x1	1/8 NPT			99
M6 to M8FL	M6x1	M8x1.25			100
M6 to M6FL	M6x1	M6x1			101
M6 to M5FL	M6x1	M5x0.8	5/64	1/4	102
M6 to M3FL	M6x1	M3x0.5			103
M6 to 1/4-28FL	M6x1	1/4-28			104
M6 to 10-32FL	M6x1	10-32			105
M5 to 1/8FL	M5x0.8	1/8 NPT			106
M5 to M8FL	M5x0.8	M8x1.25			107
M5 to M6FL	M5x0.8	M6x1			108
M5 to M5FL	M5x0.8	M5x0.8	.089	1/4	109
M5 to M3FL	M5x0.8	M3x0.5			110
M5 to 1/4-28FL	M5x0.8	1/4-28			111
M5 to 10-32FL	M5x0.8	10-32			112
1/8 to 1/8FL	1/8 NPT	1/8 NPT			113
1/8 to M8FL	1/8 NPT	M8x1.25			114
1/8 to M6FL	1/8 NPT	M6x1			115
1/8 to M5FL	1/8 NPT	M5x0.8	1/4	1/2	116
1/8 to M3FL	1/8 NPT	M3x0.5			117
1/8 to 1/4-28FL	1/8 NPT	1/4-28			118
1/8 to 10-32FL	1/8 NPT	10-32			119

Orifice Couplings have through holes drilled to exact diameters specified in inches.

**Line Number 124**

Orifice	Part No.
.005"	C1-OR-.005
.006"	C1-OR-.006
.007"	C1-OR-.007
.008"	C1-OR-.008
.009"	C1-OR-.009
.010"	C1-OR-.010
.011"	C1-OR-.011
.012"	C1-OR-.012
.013"	C1-OR-.013
.014"	C1-OR-.014
.015"	C1-OR-.015
.016"	C1-OR-.016
.017"	C1-OR-.017
.018"	C1-OR-.018
.019"	C1-OR-.019
.020"	C1-OR-.020
.025"	C1-OR-.025
.030"	C1-OR-.030
.040"	C1-OR-.040

**Line Number 125**

Orifice	Part No.
.005"	C3-OR-.005
.006"	C3-OR-.006
.007"	C3-OR-.007
.008"	C3-OR-.008
.009"	C3-OR-.009
.010"	C3-OR-.010
.011"	C3-OR-.011
.012"	C3-OR-.012
.013"	C3-OR-.013
.014"	C3-OR-.014
.015"	C3-OR-.015
.016"	C3-OR-.016
.017"	C3-OR-.017
.018"	C3-OR-.018
.019"	C3-OR-.019
.020"	C3-OR-.020
.025"	C3-OR-.025
.030"	C3-OR-.030
.040"	C3-OR-.040

**Line Number 126**

Orifice	Part No.
.025"	C4-OR-.025

Note: The general dimensions in this catalog are subject to change without notice.