

Chiller System RFCS

Symbol

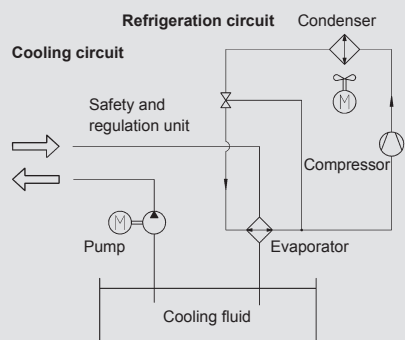

Application Field

- Machine tools
- Presses
- Milling machines
- Welding systems
- Laser cooling

Whether integrated into a machine or used as a separate auxiliary cooler or insertion cooler, the RFCS range of chillers will tackle any cooling task and guarantees quality for your products with utmost precision.

General

The RFCS cooling unit (chiller) is used to cool various liquids such as water, water glycol or oil down to the ambient temperature or below. The chiller system consists of refrigerator, pump, tank and controller and is able to set the temperature of the cooling media to a previously configured target value independently.

Product Features

- Fluid cooling system as separate auxiliary cooler or for integration into a machine
- Can be used for any cooling tasks
- Stand-alone control of the system by means of innovative controller design
- Condenser available as water-cooled or air-cooled variant
- Multiple cooling circuits
- Precise temperature control accuracies from ± 0.1 K
- Optional outdoor installation
- Think green – act green: energy-efficient mixer principle available as an option

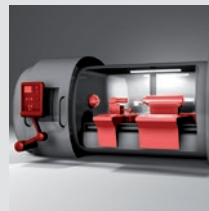
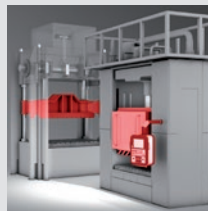

RFCS-G series



Separate auxiliary coolers with high capacities up to 160 kW for cooling tasks in the machine tool sector. Several units can be connected in parallel to expand the capacity as required.

RFCS-D series



Separate auxiliary cooler for cooling tasks in machine building (integration into the machine tool), capacities up to 7 kW

Temperature control / remote maintenance

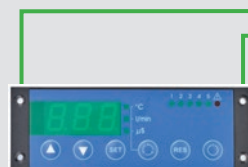

H.I.B control unit

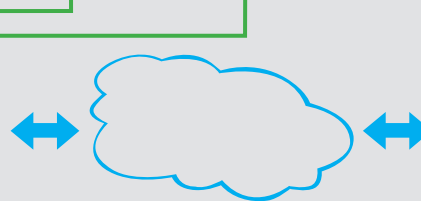

Operating Data

Series	Cooling power ¹⁾ [kW]	Condenser		Refrigerant			Pump capacity / flow rate	Electrical supply ¹⁾	Dimensions LxDxH [mm]	Weight [kg]
		air- cooled	water- cooled	DI ²⁾	IW ³⁾	Direct ⁴⁾ (without tank)				
G0	1.0	●	●	●	●	●	10 l/min @ 1.5 bar	230V - 50/60Hz	443 x 524 x 443	43
	1.5	●	●	●	●	●	10 l/min @ 1.5 bar	230V - 50/60Hz	443 x 524 x 443	45
	2.3	●	●	●	●	●	10 l/min @ 1.5 bar	230V - 50/60Hz	443 x 524 x 443	48
D2	3.3	●	●	●	●	●	15 l/min @ 2 bar	230V - 50/60Hz	480 x 420 x 800	80
	3.3	●	●	●	●	●	15 l/min @ 2 bar	400/440V - 50/60Hz	480 x 420 x 800	80
D3	4.5	●	●	●	●	●	15 l/min @ 2 bar	400/440V - 50/60Hz	595 x 555 x 1,131	130
	5.6	●	●	●	●	●	15 l/min @ 2 bar	400/440V - 50/60Hz	595 x 555 x 1,131	130
D4	7.5	●	●	●	●	●	40 l/min @ 3 bar	400/440V - 50/60Hz	601 x 601 x 1,361	160
G4	7.5	●	●	●	●	●	40 l/min @ 3 bar	400/440V - 50/60Hz	601 x 601 x 1,527	200
	9.5	●	●	●	●	●	40 l/min @ 3 bar	400/440V - 50/60Hz	601 x 601 x 1,527	250
G5	12	●	●	●	●	●	40 l/min @ 3 bar	400/440V - 50/60Hz	601 x 601 x 2,131	300
	15	●	●	●	●	●	40 l/min @ 3 bar	400/440V - 50/60Hz	601 x 601 x 2,131	300
G6	20	●	●	●	●	●	40 l/min @ 3 bar	400/440V - 50/60Hz	1,230 x 610 x 2,131	350
	26	●	●	●	●	●	40 l/min @ 3 bar	400/440V - 50/60Hz	1,230 x 610 x 2,131	380
	32	●	●	●	●	●	40 l/min @ 3 bar	400/440V - 50/60Hz	1,230 x 610 x 2,131	400
G7	40	●	●	●	●	●	90 l/min @ 3 bar	400/440V - 50/60Hz	1,860 x 1,000 x 2,134	1,000
	50	●	●	●	●	●	90 l/min @ 3 bar	400/440V - 50/60Hz	1,860 x 1,000 x 2,134	1,000
	60	●	●	●	●	●	90 l/min @ 3 bar	400/440V - 50/60Hz	1,860 x 1,000 x 2,134	1,000
	70	6)	●	●	●	●	150 l/min @ 3 bar	400/440V - 50/60Hz	1,860 x 1,000 x 2,021	750
	90	6)	●	●	●	●	150 l/min @ 3 bar	400/440V - 50/60Hz	1,860 x 1,000 x 2,021	770
	100	6)	●	●	●	●	150 l/min @ 3 bar	400/440V - 50/60Hz	1,860 x 1,000 x 2,021	780
	135	6)	●	●	●	●	250 l/min @ 3 bar	400/440V - 50/60Hz	1,860 x 1,000 x 2,021	800
	155	6)	●	●	●	●	250 l/min @ 3 bar	400/440V - 50/60Hz	1,860 x 1,000 x 2,021	900

1) Cooling capacity based on 35°C ambient air / water to condenser and 20°C process fluid supply temperature

2) DI = deionized water

3) IW = industrial water

4) Direct = Direct vaporization without refrigerant

5) Standard, additional voltages on request

6) Available as air-cooled variant with external condenser or heat exchanger



Accessories

- Higher capacity pumps available
- Several parallel circuits
- Ambient temperature-dependent control using separate temperature sensor
- Serial interface for system monitoring
- Filtration units for the refrigerant circuit
- Flow indicator and flow monitoring
- Extremely accurate control up to ± 0.1 K, standard ± 1.5 K
- Speed-controlled fans

Design

In the standard versions, the RFCS cooling units are designed complete with compressor, air cooled condenser, submersible pump and electronic control. Optionally available with energy-efficient mixer control where a small hysteresis is required.



G0



D2



D3



D4



G4



G5



G6



G7

Centralized Cooling Systems

RFCS water-chiller with heat exchanger and HY-ECOBIX

RFCS water chiller:

The RFCS is used to prepare cold water. Regardless of the particular ambient temperature, cold water can be provided in a wide range of capacity classes and fed to the customer application.

The unit is a water-cooled water chiller. The plate heat exchanger condenser transfers its process heat to a separate cooling-water circuit.

Heat exchanger:

RFCS cooling units with water-cooled condenser require a cooled water supply for heat removal. A heat exchanger is used when it is either not practical or not desirable to utilize mains water.

HY-ECOBIX:

The HY-ECOBIX is an optional module which contributes to improved energy saving: when the ambient temperature drops below a certain level, the cooling machine's active cooling is switched off. The system then operates in passive cooling mode, using the heat exchanger. This energy manager can therefore only be used in combination with a heat exchanger.

Advantages:

- Saves resources, as no water is used
- High energy-saving potential thanks to the HY-ECOBIX*
- The RFCS transfers no heat into the building

* ECOBOX: optional accessory for passive free cooling operation

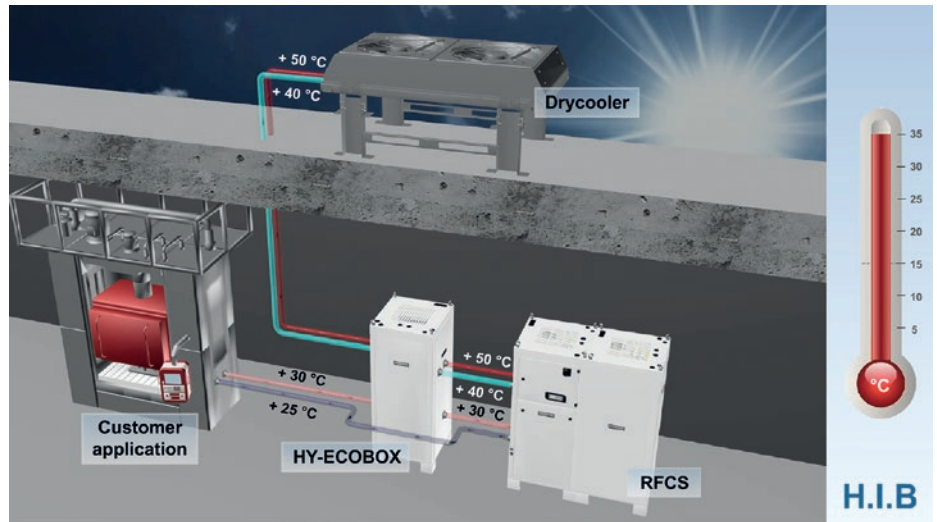

Functioning at high external temperatures

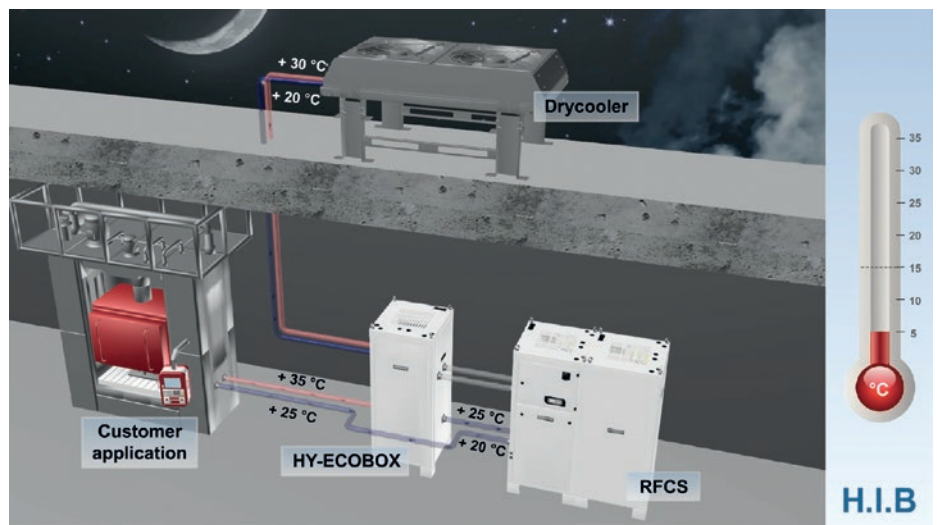

Functioning at low external temperatures

From the prototype to series production

- **Planning and advice** from our specialists on site.
You provide the task, we supply the solution.
- Our own **development centre** produces market-driven, energy-efficient and cutting-edge solutions, to stay one step ahead of the “state of the art”.
- The coolers are **produced** in the Bavarian town of Friedberg and rightly deserve the “Made in Germany” seal of quality!
- In order to provide **quality** that is consistently very good, all equipment must undergo a function and performance test.
- For **service** you can call on an international network of service engineers. Consultation and service – with global reach.

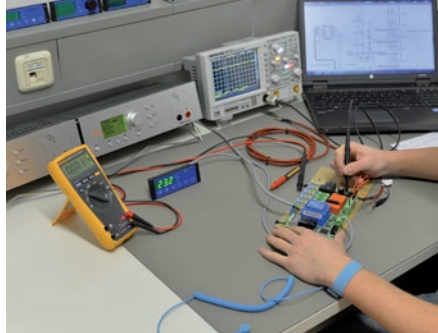

Design Data Sheet, RFCS Cooling Unit

Project: _____
 Contact: _____
 Telephone: _____
 E-mail: _____
 Date _____ Created by _____

Application

Active cooling (RFCS): air-cooled
 water-cooled

Installation site: Indoors Outdoors

Series/housing*: D G

Technical data

Required cooling capacity: _____ kW
 at _____ °C operating temperature
 and _____ °C ambient temperature

Relative humidity: _____ %RH

Operating temperature adjustable from: _____ °C to _____ °C

Supply voltage: _____ V _____ Ph _____ Hz

Temperature accuracy and control type

Control accuracy: ±0.1 K ±0.5 K ±1.5 K

Control type: Fixed value Controlled by ambient temperature

Cooling fluid/refrigerant

Cooling fluids: Water glycol DI water Mineral oil

% glycol: _____ %
 Conductance: _____ μS/cm
 ISO _____ / _____ cSt

Pump specifications

Flow rate: _____ l/min

Operating pressure: _____ bar

Connection system, cooling circuit: _____ " internal thread

Additional information on water-cooled RFCS: external cooling water supply

Inlet temperature: min. _____ °C max. _____ °C

Guaranteed water quantity: _____ l/min

Pressure p: min. _____ bar max. _____ bar

Cooling water supply: _____ e.g. well water, fresh water

Equipment

Comment

- Paint (standard RAL 7035): _____
- Tank heating _____
- Flow monitoring _____
- Flow indicator _____
- Filter for cooling fluid (particle filter) Filtration rating: _____ µm
- Controlled fan _____
- Air filter monitoring _____
- DI cartridges _____
- Conductance monitoring _____
- Conductance control Switching point: _____ µS/cm

Electric system

Comment

- Cooler plug connector with mains filter _____
- Power adaptor (internal 24 V supply) _____
- Power supply cable _____
- Main switch _____
- Remote start (potential-free contact) _____
- Supply / elec. connection Design: (e.g. industrial connector, multi-pin) _____
- Transformer for special voltage _____
- Data interface (e.g. RS485) _____
- Interface specification _____

Other accessories:

Comments:

Annual unit qty.:

*** Series/housing:**

The D basic housing is equipped with a horizontal condenser, making for flexible air routing/setup as access to the insides of the devices only needs to be possible from one side. The G basic housing is fitted with an upright condenser to provide compact installation space requirements even at higher capacity levels.

Note

The information in this brochure relates to the operating conditions and applications described.

For applications and operating conditions not described, please contact the relevant technical department.

Subject to technical modifications and corrections.

H.I.B HYDAC INTERNATIONAL

H.I.B Systemtechnik GmbH
Winterbrückenweg 30
86316 Friedberg-Derching
Germany
Tel.: +49 821/747 71-400
Fax: +49 821/747 71-410
E-mail: info@h-i-b.de
Internet: www.h-i-b.de

HYDAC COOLING GMBH
Industriegebiet
66280 Sulzbach / Saar
Germany
Tel.: +49 6897/509-01
Fax: +49 6897/509-454
E-mail: cooling@hydac.com
Internet: www.hydac.com