

## Mounting Hardware

### Product Description

#### One-Hole Mounting Switches

All bushing mounted switches are furnished with two mounting nuts. One nut is mounted behind the panel to prevent the bushing sleeve from being distorted if the front panel is overtightened

Eaton accepts no responsibility for damage to switches mounted without the backup nuts.

### Product Selection

#### Mounting Hardware for One-Hole Mounting Switches—Mounting Nuts <sup>①</sup>

Size	Description	Material	Thickness Dim. "A" in Inches (mm)	Inside Diameter Dim "B" in Inches (mm)	OD or Dimension Across Flats Dim. "C" in Inches (mm)	Dimension Across Corners Dim. "D" in Inches (mm)	Catalog Number
3/8-27	Hexagon locknut	Nickel-plated brass	0.125 (3.18)	—	0.562 (14.27)	0.625 (15.88)	15-2526-2
3/8-24		Bright nickel-plated brass		—			15-1525-6
11/32-32		Nickel-plated brass	0.063 (1.60)	—	0.473 (12.01)	0.531 (13.49)	15-1525-2
15/32-32	Hexagon locknut	Zinc-chromate treated	0.075 (1.91)	—	0.625 (15.88)	—	15-192
		Bright nickel-plated brass	0.078 (1.98)	—	0.546 (13.87)	0.625 (15.88)	15-2525-58
		Zinc-chromate treated	0.188 (4.76)	0.783 (19.89)	1.125 (28.80)	—	15-2528-2
	Hexagon facenut	Nickel-plated brass	0.078 (1.98)	—	0.562 (14.27)	0.656 (16.66)	15-966-2
		Semi-lustre nickel-plated brass		—			19-966-6
	Knurled facenut	Bright nickel-plated brass	0.066 (1.68)	—	0.562 (14.27)	—	15-124F1
		Black cupric oxide-plated brass		—		—	15-124F5
		Brass nickel-plated brass	0.109 (2.77)	—	0.625 (15.88)	—	15-90
	Chamfered dress nut	Bright nickel-plated brass	0.151 (3.84)	0.312 (7.92)	0.687 (17.45)	—	15-994-2
	Standard knurl nut with shoulder	Nickel-plated brass	0.109 (2.77)	—	0.593 (15.06)	—	15-2534-14
	Dress nut	Satin chrome-plated brass	0.125 (3.18)	—	0.562 (14.27)	—	15-2523-4
		Black nylon	0.187 (4.75)	0.390 (9.91)	0.640 (16.26)	—	15-1048-3
	Knurled dress nut	Chrome-plated brass	0.187 (4.75)	0.312 (7.92)	0.640 (16.26)	—	15-189-5
3/4-32	Hexagon facenut	Nickel-plated steel	0.093 (2.36)	—	0.937 (23.80)	1.078 (27.38)	15-1043
#8-40	Hexagon locknut with facenut	Nickel-plated steel	0.060 (1.52)	—	0.245 (6.22)	0.216 (5.49)	15-1047

#### Note

<sup>①</sup> Hardware items are sold for use with Eaton switches only. Minimum ordering quantity on all items is 100.

### Mounting Washers and Locking Ring ①

Approximate Dimensions in Inches (mm)

Size	Description	Material	Thickness Dim. "A"	Inside Diameter Dim "B"	OD or Dimension Across Flats Dim. "C"	Dimension Across Corners Dim. "D"	Catalog Number
For 15/32 bushing	Locking ring	Zinc-plated steel	0.040 (1.02)	0.475 (12.07)	0.718 (18.24)	—	29-761-5

## 4

### Dimensions

Approximate Dimensions in Inches (mm)

### Mounting Hardware

Hexagon Locknuts or Facenuts

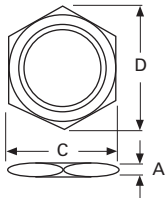

Knurled Facenut

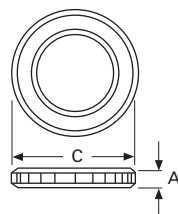

Knurled Nut with Shoulder

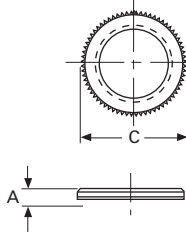

Chamfered Dress Nut  
Catalog No. 15-994-2

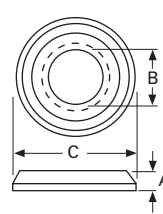

Knurled Dress Nut  
Catalog No. 15-189-5

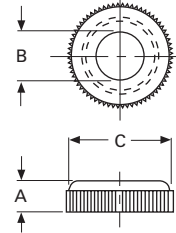

Knurled Dress Nut  
Catalog No. 15-1048-3

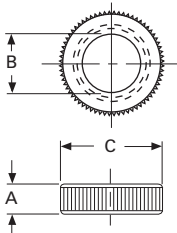

Dress Nut  
Catalog No. 15-2523-4

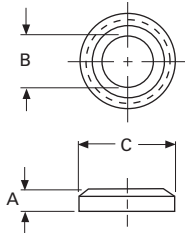

Plain Washer

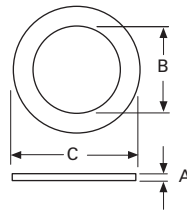

Internal Tooth  
Lockwasher

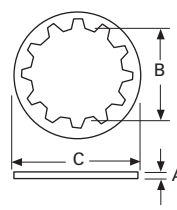

Locking Ring

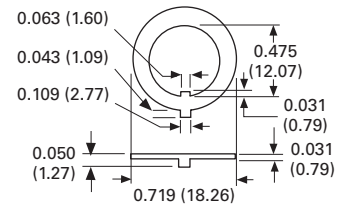

### Note

① Hardware items are sold for use with Eaton switches only.

### Decorator Facenuts

#### Product Selection <sup>①</sup>

Type	Color	Catalog Number
Knurled facenuts	Bright black	15-1048-3
	Bright clear	15-1048-7
Beveled facenuts	Bright black	15-1049-3
	Bright clear	15-1049-7

#### Dimensions

Approximate Dimensions in Inches (mm)

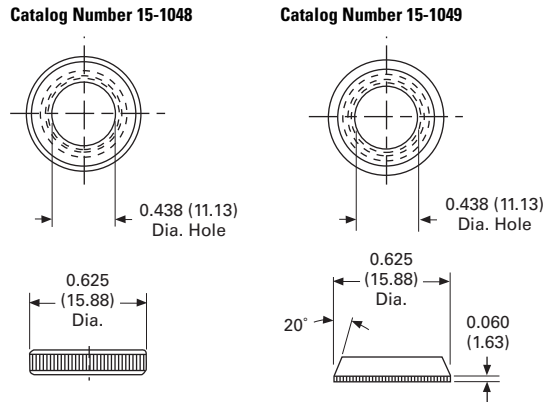

#### Panel Seal

- Prevents moisture and contaminants from entering panel enclosure
- Behind panel mounting
- Stainless-steel cup washer ensures proper seating of silicone rubber seal
- Seal withstands 20 psi water pressure
- Cat. No. 32-341

#### Dimensions—32-341

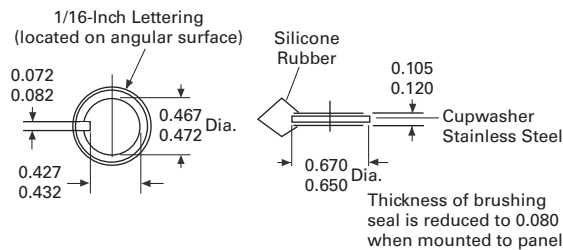

### Replacement Terminal Screws

#### Product Selection

Screw Size	Catalog Number <sup>②</sup>
#5-40 x 1/8 in	11-1117
#5-40 x 5/32 in	11-26
#5-40 x 3/16 in binding head	811-7206
#5-40 x 1/4 in binding head	811-14
#6-32 x 3/16 in binding head	811-2
#6-32 x 1/4 in binding head	811-161
#6-32 x 1/4 in binding head	811-7248
#6-32 x 1/4 in pan head, brass	11-1893
#6-32 x 3/8 in binding head	811-129
#8-32 x 3/16 in binding head	11-1618
#8-32 x 1/4 in	11-1369
#8-32 x 1/4 in	811-408-2
#8-32 x 3/8 in binding head	11-1766
#8-32 x 3/8 in binding head	11-6074-4
#6-32 x 7/32 in binding head	11-6085-2

#### Toggle Boot

- Prevents moisture and contaminants from entering lever to bushing enclosure
- Front panel mounting
- Threaded mounting nut ensures proper assembly of silicon rubber boot
- Brass nut: 15/32-32 NS-2A
- Black color

#### Product Selection

SW1RY3030	Mounting Description	Color	Catalog Number
	Front panel mounting Molded in brass mounting nut (15/32-32 NS-2A) ensures proper assembly of silicon rubber boot	Black	SW1RY3030

#### Dimensions—15/32-32 NS-2A

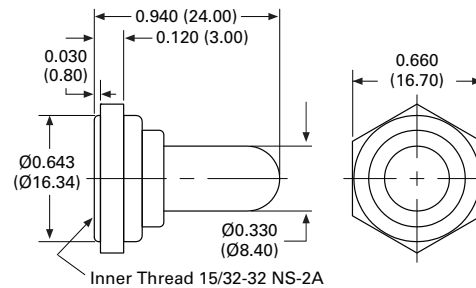

#### Notes

- Decorator facenuts for 15/32 in bushing switches, 15/32-32 thread.
- Hardware items are sold for use with Eaton switches only.

### Indicating Plates

#### Product Selection—Indicating Plates for 15/32-Inch Bushing Mounted Switches

4



Keyway Location	Marking Opposite Keyway	Keyway Side	Material	Finish	Catalog Number	
Keyway on bottom	ON	OFF	0.032 in steel	Plain	<b>30-5632</b>	
				Statuary bronze	<b>30-5632-3</b>	
				Burnished nickel	<b>30-5632-4</b>	
	RAD	PHO	0.032 in steel	0.032 in brass	Black cupric oxide <sup>①</sup>	<b>30-2899-3</b>
				Statuary bronze	<b>30-5632-7</b>	
	RUN	START	0.032 in steel	Burnished nickel	<b>30-5632-11</b>	
					<b>30-5632-15</b>	
	HOT	COLD			<b>30-5632-16</b>	
	HI	LOW			<b>30-5632-17</b>	
	ON	STOP			<b>30-5632-17</b>	
	FOR	REV	0.032 in steel	Burnished nickel	<b>30-2899-2</b>	
	AUTO	TEST			<b>30-2899-6</b>	
	PUSH	START			<b>30-2899-7</b>	
RUN	TEST			<b>30-2899-9</b>		
BLANK	BLANK	0.032 in steel	Burnished nickel	<b>30-5632-8</b>		
Keyway on side	ON	OFF	0.032 in steel	Burnished nickel	<b>30-5632-13</b>	
	OFF	ON			<b>30-2899-8</b>	
Keyway on top	T	B	0.032 in steel	Burnished nickel	<b>30-5632-12</b>	
	OFF	ON			<b>30-5632-14</b>	
	SET	RUN			<b>30-2899-10</b>	
	BLANK	RESET			<b>30-2899-12</b>	
Keyway on top	O	I	0.032 in steel	Burnished nickel	<b>30-5632-23</b>	
	I	O			<b>30-5632-19</b>	



### Dimensions

Approximate Dimensions in Inches

#### Indicating Plate

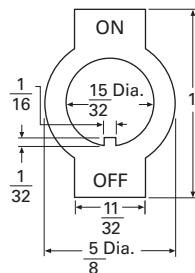

#### Note

<sup>①</sup> White lettering.