

# 6.2

## Pushbuttons

Illuminated AC/DC Rated

Illuminated AC/DC Rated

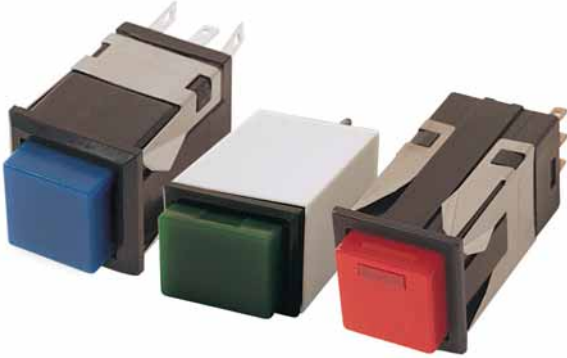

6

### Contents

Description	Page
Illuminated AC/DC Rated	
Catalog Number Selection	V11-T6-9
Lamp Selection	V11-T6-14
Accessories	V11-T6-16
Technical Data and Specifications	V11-T6-17
Terminal Identification	V11-T6-18
Circuit Diagrams	V11-T6-18
Legends	V11-T6-18
Dimensions	V11-T6-19

### Product Description

Eaton offers a wide range of pushbutton switches for standard industry applications such as appliances, electronics, medical and test instrumentation, office equipment and many other commercial applications.

A variety of options are available such as illuminated and non-illuminated versions, colored lens caps, lamp styles and mounting styles.

Each pushbutton series offers a matching indicator for a consistent look. See the Product Overview tables to quickly identify the required product. Then, refer to the Catalog Number Selection and Product Selection tables to determine the catalog number.

### Standards and Certifications <sup>①</sup>

- UL Recognized
- CSA Certified
- RoHS <sup>②</sup>









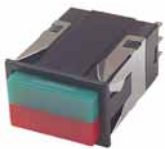

#### Notes

- ① Except where noted.
- ② Visit [www.eaton.com/vcbu](http://www.eaton.com/vcbu) for the most up-to-date list of verified part numbers.

### Product Selection Guide

#### General Purpose Pushbuttons and Indicators—Illuminated and Non-Illuminated

Series	206/208	Page	220/221/224	Page	231/234	Page	580/581/586	Page
Pushbutton Selection—Switch		V11-T6-9		V11-T6-9		V11-T6-9		V11-T6-10
Pushbutton Selection—Indicator		V11-T6-9		V11-T6-9		V11-T6-9		V11-T6-10
Pushbutton Cap Selection		V11-T6-13		V11-T6-13		V11-T6-13		V11-T6-13
Circuit Diagram Letter (See Page V11-T6-18)		K, N		K, N		K, N		J, L, M
Series	770/775	Page	810/815	Page	820/825	Page	860/861/845	Page
Pushbutton Selection—Switch		V11-T6-11		V11-T6-12		V11-T6-12		V11-T6-12
Pushbutton Cap Selection		V11-T6-11		V11-T6-12		V11-T6-12		V11-T6-12
Pushbutton Selection—Indicator		V11-T6-13		V11-T6-13		V11-T6-13		V11-T6-13
Circuit Diagram Letter (See Page V11-T6-18)		Q		K, N		K, N		J, L

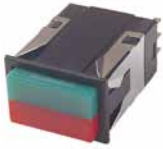

Series 206/208, 220 and 221/224, 231/234

Catalog Number Selection

How To Order—Series 206/220 and 221/231, Switch

To determine complete catalog number, start with the appropriate control type and add the appropriate code letters and/or numbers.

Example: **206 K 1 1 9 1 2 D 03 05 S 30**

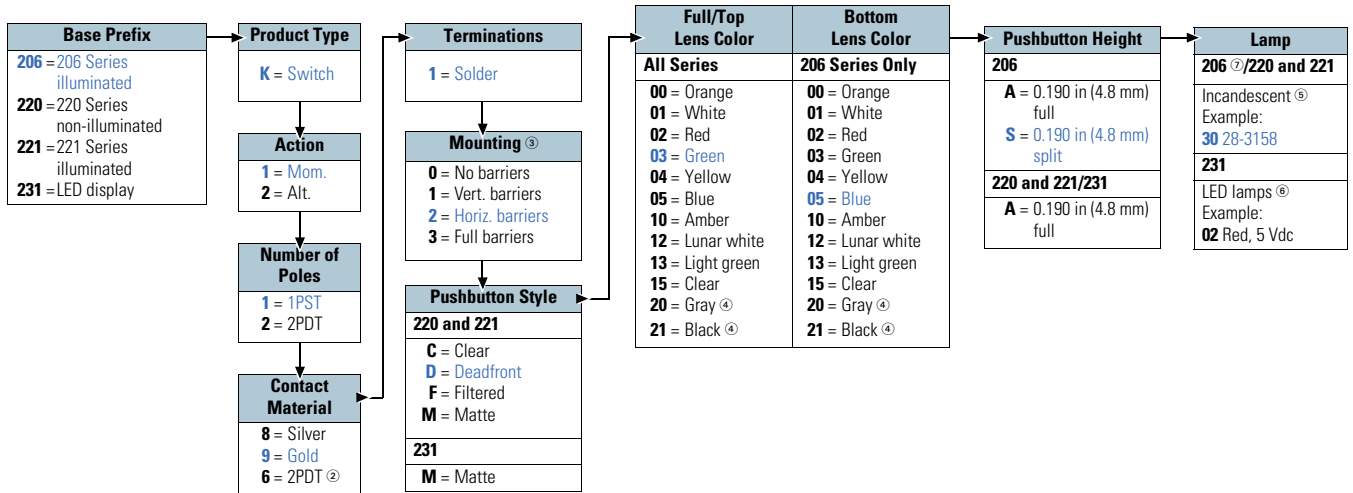

How To Order—Series 208/224/234, Indicator

To determine complete catalog number, start with the appropriate control type and add the appropriate code letters and/or numbers.

Example: **208 L 1 2 D 03 05 S 30**

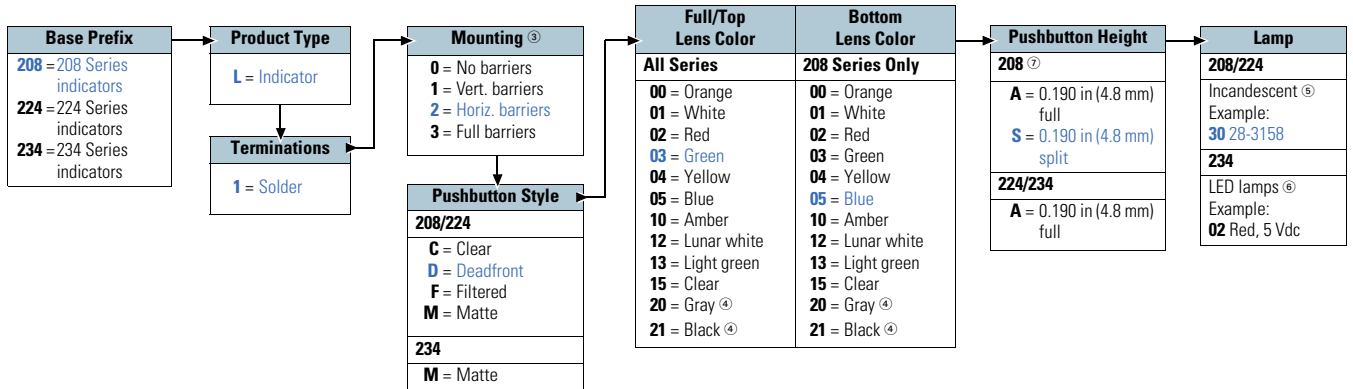

Notes

- ① Full cap style does not require a bottom lens code.
- ② Pole one is silver, pole two is gold.
- ③ Refer to Page V11-T6-16 for barrier information.
- ④ Not available with lighted display.
- ⑤ Use two-digit item number, 30–37, from Incandescent Lamps table on Page V11-T6-14.
- ⑥ Use two-digit item number, 01–19, from LED Lamps table on Page V11-T6-15.
- ⑦ Accepts two bulbs.

# 6.2

## Pushbuttons

Illuminated AC/DC Rated



Series 580/581/586

### Catalog Number Selection

6

#### How To Order—Series 580/581, Switch

To determine complete catalog number, start with the appropriate control type and add the appropriate code letters and/or numbers.

Example: **581 K 1 3 9 1 0 T 03 B 30**

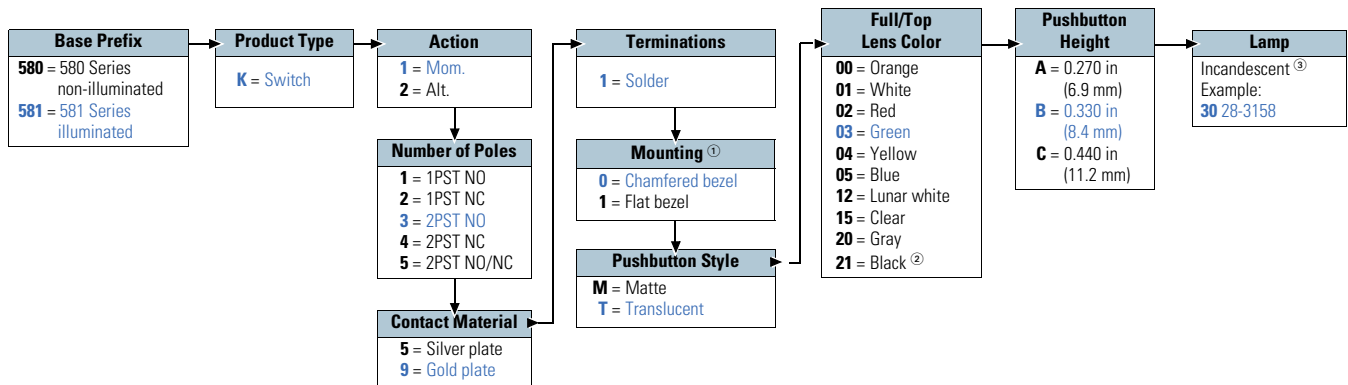

#### How To Order—Series 586, Indicator

To determine complete catalog number, start with the appropriate control type and add the appropriate code letters and/or numbers.

Example: **586 L 1 0 T 03 B 30**

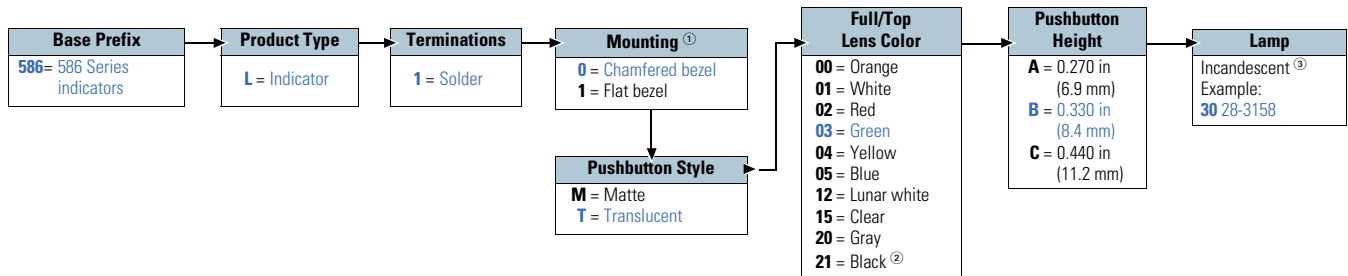

#### Notes

- ① Flush with bezel.
- ② Not available with lighted display.
- ③ Use two-digit item number, 30–37, from Incandescent Lamps table on Page V11-T6-14.



Series 770/775

Catalog Number Selection

How To Order—Series 770<sup>①</sup>, Switch

To determine complete catalog number, start with the appropriate control type and add the appropriate code letters and/or numbers.

Example: **770 K 1 1 9 1 1 M 03 01 G 80**

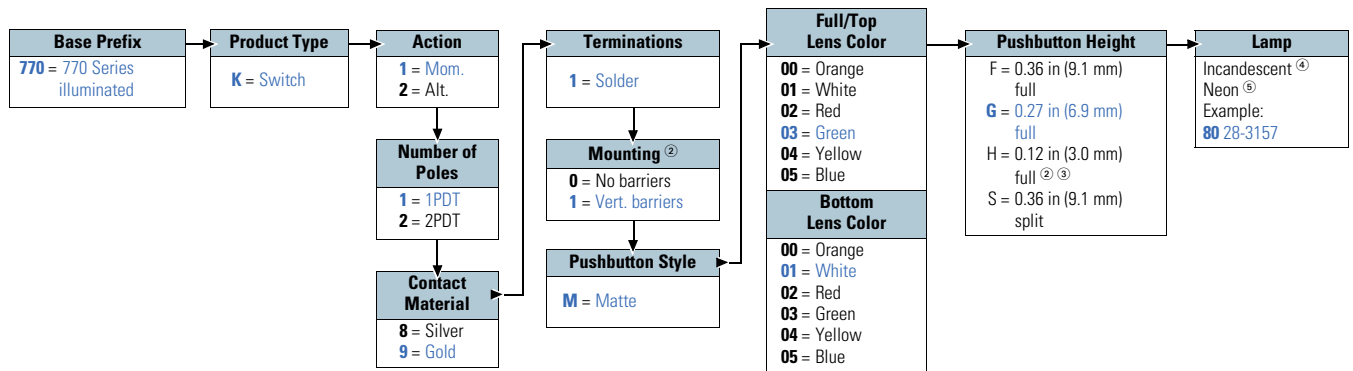

How To Order—Series 775<sup>①</sup>, Indicator

To determine complete catalog number, start with the appropriate control type and add the appropriate code letters and/or numbers.

Example: **775 L 1 1 M 03 01 G 80**

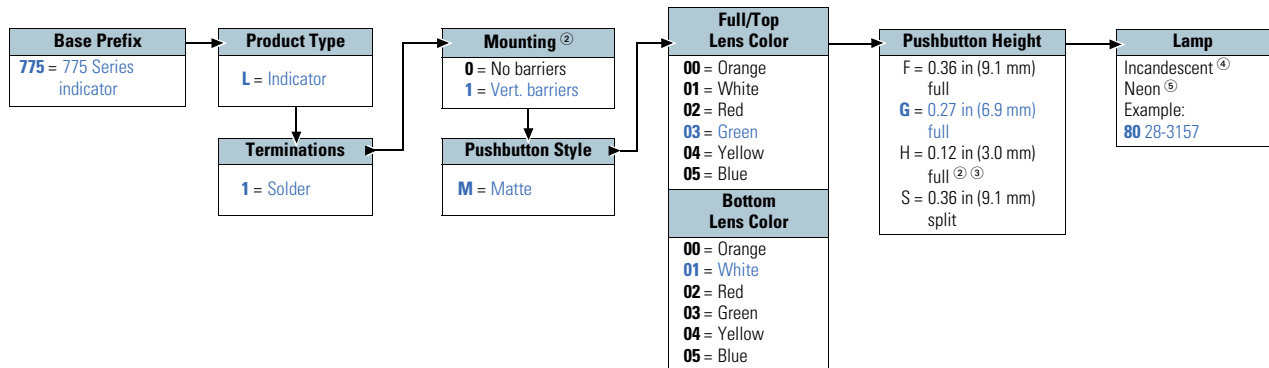

Notes

- ① Full or split cap style available.
- ② Flush with bezel.
- ③ Not available with lighted display.
- ④ Use two-digit item number, 51–59, from Incandescent Lamps table on Page V11-T6-14.
- ⑤ Use two-digit item number, 80 or 81, from Neon Lamps table on Page V11-T6-15.

# 6.2

## Pushbuttons

Illuminated AC/DC Rated



Series 860 and 861/845, 810/815, 820/825

### Catalog Number Selection

6

#### How To Order—Series 860 and 861/810/820, Switch ①

To determine complete catalog number, start with the appropriate control type and add the appropriate code letters and/or numbers.

Example: **861 K 1 3 9 1 2 D 03 B 02**

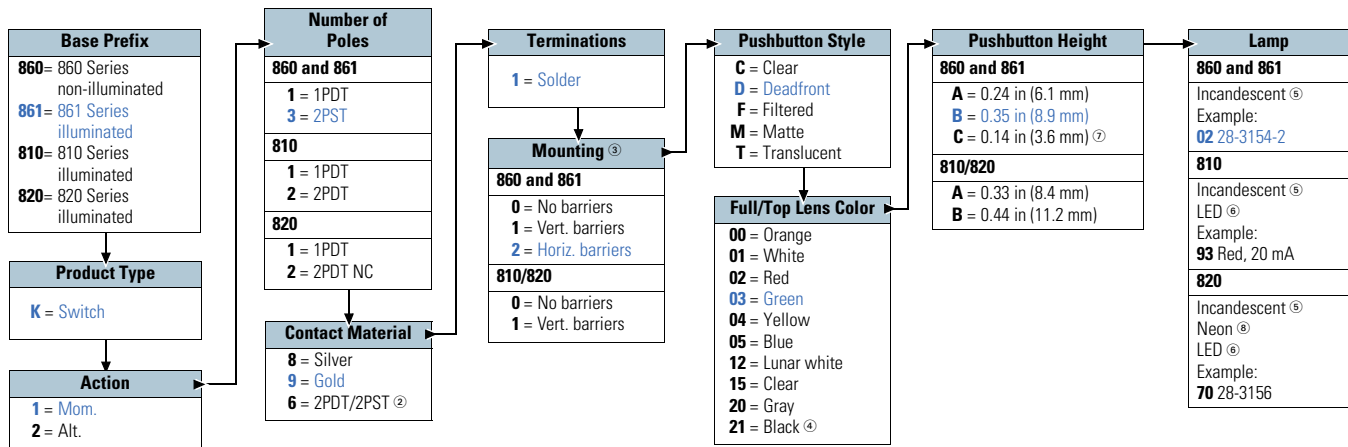

#### How To Order—Series 845/815/825, Indicator ①

To determine complete catalog number, start with the appropriate control type and add the appropriate code letters and/or numbers.

Example: **845 L 1 2 D 03 B 30**

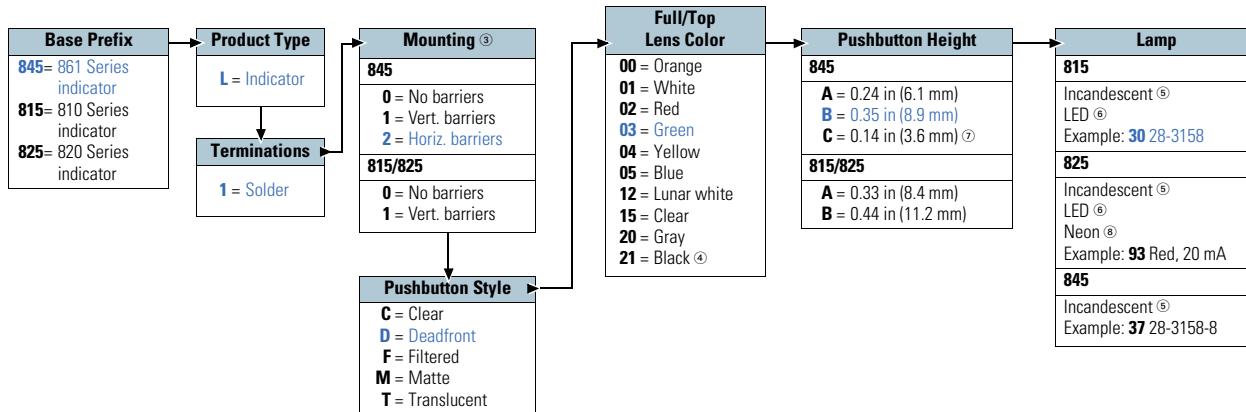

#### Notes

- ① Full cap style does not require a bottom lens code.
- ② Pole one is silver, pole two is gold.
- ③ Flush with bezel.
- ④ Not available with lighted display.
- ⑤ Use two-digit item number, 02–14, from Incandescent Lamps table on Page V11-T6-14.
- ⑥ Use two-digit item number, 93–97, from LED Lamps table on Page V11-T6-15.
- ⑦ Not available with lighted display. Available only on "M."
- ⑧ Use two-digit item number, 70, from Neon Lamps table on Page V11-T6-15.

**Illuminated and Non-Illuminated Pushbutton Caps**



**Series 206/220/231 and Series 580/770/810/820/849**

**Catalog Number Selection**

**How To Order—Series 206/220/231, Pushbutton Caps**

To determine complete catalog number, start with the appropriate control type and add the appropriate code letters and/or numbers.

**Example: 206 P C 03 04 S**

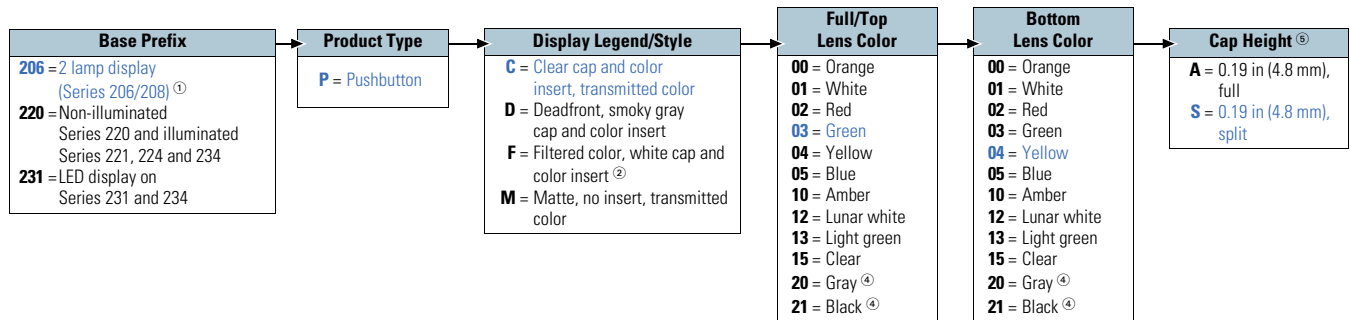

**How To Order—Series 580/770/810/820/849, Pushbutton Caps**

To determine complete catalog number, start with the appropriate control type and add the appropriate code letters and/or numbers.

**Example: 580 P C 03 04 B**

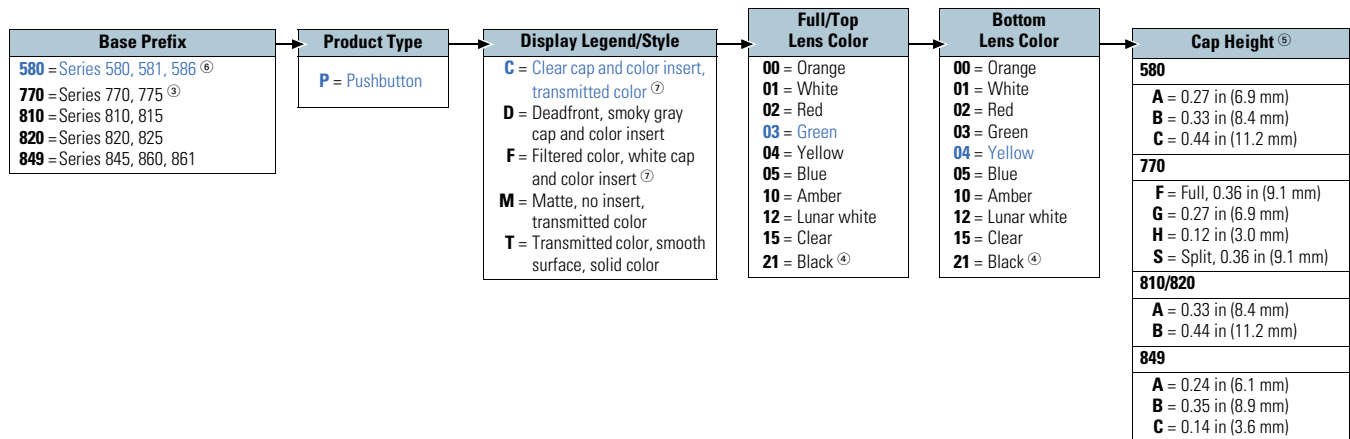

**Notes**

- <sup>1</sup> For a high degree of illumination, a full cap may be used with two lamp devices.
- <sup>2</sup> Available only with colors red, green, yellow and blue.
- <sup>3</sup> Available in matte only.
- <sup>4</sup> Not available for lighted display.
- <sup>5</sup> Measured from panel of top of pushbutton cap.
- <sup>6</sup> Available in translucent and matte only.
- <sup>7</sup> For two lamps, two colored inserts with divider.

## Lamp Selection

## Incandescent Lamps

## Bi-Pin Base for 800 Series

Item Number <sup>①</sup>	To Order Lamp Separately	ASA Lamp Number	Designed Volts	Design Amps	Brightness (MSCP) <sup>②</sup>	Brightness (Lumens)	Lab Average Life (Hours) <sup>③</sup>
02	28-3154-2	7361	5	0.06	0.05	0.63	100,000
03	28-3154-3	7945	6	0.04	0.03	0.38	10,000
07	28-3154-7	7381	6.3	0.20	0.40	5.03	50,000
08	28-3154-8	7371	12	0.04	0.12	1.51	10,000
09	28-3154-9	7330	14	0.08	0.50	6.29	750
10	28-3154-10	7382	14	0.08	0.30	3.77	50,000
11	28-3154-11	7370	18	0.04	0.15	1.89	10,000
12	28-3154-12	7327	28	0.04	0.34	4.27	7,000
13	28-3154-13	7387	28	0.04	0.30	3.77	25,000
14	28-3154-14	7876	28	0.06	0.34	4.27	25,000

## Midget Flange Base for 770 Series

Item Number <sup>①</sup>	To Order Lamp Separately	ASA Lamp Number	Designed Volts	Design Amps	Brightness (MSCP) <sup>②</sup>	Brightness (Lumens)	Lab Average Life (Hours) <sup>③</sup>
51	28-3155-2	345	6	0.04	0.03	0.38	10,000
54	28-3155-5	394	12	0.04	0.12	1.51	10,000
55	28-3155-6	330	14	0.08	0.50	6.29	750
56	28-3155-7	382	14	0.08	0.30	3.77	50,000
57	28-3155-8	370	18	0.04	0.15	1.89	10,000
58	28-3155-9	327	28	0.04	0.34	4.27	7,000
59	28-3155-10	387	28	0.04	0.30	3.77	25,000

## Subminiature Wedge Base for 200 and 500 Series

Item Number <sup>①</sup>	To Order Lamp Separately	ASA Lamp Number	Designed Volts	Design Amps	Brightness (MSCP) <sup>②</sup>	Brightness (Lumens)	Lab Average Life (Hours) <sup>③</sup>
30	28-3158	56	5	0.115	0.15	1.89	20,000
31	28-3158-2	79	6	0.20	0.60	7.92	1,000
32	28-3158-3	84	6.3	0.04	0.03	0.38	20,000
33	28-3158-4	86	6.3	0.20	0.40	5.03	20,000
34	28-3158-5	18	14	0.04	0.13	1.63	5,000
35	28-3158-6	73	14	0.08	0.30	3.77	15,000
36	28-3158-7	85	28	0.04	0.30	3.77	7,000
37	28-3158-8	17	28	0.06	0.65	8.17	5,000

**Notes**

① Use this two-digit number for installation in switches and indicators.

② Standard tolerance for MSCP is  $\pm 25\%$ .

③ Average life is for AC operation. DC life will be approximately 50% less. Operating incandescent lamps at 5–10% below rated voltage will generally increase lamp life 200–400%.

**Neon Lamps** <sup>①</sup>

**T 1-3/4 Bi-Pin Base Neon Lamp for All 800 Series “Shorty” Switches and Indicators** <sup>②</sup>

Item Number <sup>③</sup>	To Order Lamp Separately	CLC Lamp Number	Circuit Volts		Nominal Current MA	Average Useful Life (Hours)	External Resistance Required	Ignition Voltage		Bulb Size	Lamp Length	Lead Length
			AC	DC				AC	DC			
70	28-3156	7A1H	105–125	150	1.5	25,000	47K (1/4 W)	95	135	T-2	0.60	0.25

**T 1-3/4 Midget Flange Base Neon Lamps for All 700 Series Switches and Indicators** <sup>②</sup>

Item Number <sup>③</sup>	To Order Lamp Separately	CLC Lamp Number	Circuit Volts		Nominal Current MA	Average Useful Life (Hours)	External Resistance Required	Built-In Resistance	Ignition Voltage		Bulb Size	Maximum Overall Length
			AC	DC					AC	DC		
80	28-3157	A1H	105–125	150	1.5	25,000	35K (1/4 W)	None	95	135	T-2	0.67
81	28-3157-2	C-24	105–125	150	4.2	8,000	None	35K	95	135	T-2	0.67

**LED Lamps** <sup>④</sup>

LEDs are sold installed only.

**LEDs for Series 231 through 235 Switches and Indicators**

Color	Voltage <sup>⑤</sup>	Without Diode Protection	With Diode Protection
		Item Number	Item Number
Red	Vdc <sup>⑥</sup>	01	11
	5 Vdc	02	12
	15 Vdc	03	13
Yellow	Vdc <sup>⑥</sup>	04	14
	5 Vdc	05	15
	15 Vdc	06	16
Green	Vdc <sup>⑥</sup>	07	17
	5 Vdc	08	18
	15 Vdc	09	19

**T 1-3/4 Wire LEDs for All 800 Series Switches and Indicators**

Item Number <sup>③</sup>	Color	Forward Current (MA) <sup>⑤</sup>	Luminous Intensity (MCD)		Forward Voltage (V) Typical	Diffused or Undiffused
			Minimum	Typical		
93	Red	20	80	160	1.7	Undiffused
95	Green	20	80	160	1.7	Undiffused
96	Yellow	20	80	160	1.7	Undiffused
97	Amber	20	80	160	1.7	Undiffused

**Notes**

- ① Neon lamps are not recommended for use with colored caps or inserts, especially those colored green or blue.
- ② Recommended external series resistor values shown for indicated average useful life are for lamp and resistor combinations used across 110–125 Vac, 1/4 W, ±10% tolerance.
- ③ Use this two-digit number for installation in switches and indicators.
- ④ For use with clear or white cap only.
- ⑤ 5 Vdc and 15 Vdc include internal current limiting resistor. Other voltages available—contact your local Eaton Sales Representative.
- ⑥ External current limiting required. User must include in circuit—to give current of 20 mA to LED.



# 6.2

## Pushbuttons





Illuminated AC/DC Rated

### Mounting Barriers Ordering Guide

Catalog Number Example: **200B1**

When switches are individually mounted, add 0.10 in (2.54 mm) per switch to the appropriate bezel dimension. When switches are gang mounted, add 0.05 in (1.27 mm) to the appropriate bezel dimension for each switch mounted plus an additional 0.05 in (1.27 mm) to compensate for gang mounting.

#### Series 200 and 300 Mounting Barriers <sup>①②</sup>

Product Series	Product Type	Code	Barrier Type and Description	Code		
200	Barrier	<b>B</b>	End—Short <sup>③</sup>	<b>1</b>		
			Center—Short <sup>③</sup>	<b>2</b>	<b>Type 1</b>	<b>Type 2</b>
			End—Long <sup>④</sup>	<b>3</b>		
			Center—Long <sup>④</sup>	<b>4</b>	<b>Type 3</b>	<b>Type 4</b>

### Legending

All legend markings are pad printed in accordance with the limitations below. Standard markings are of condensed gothic type, 1/8 in high characters, with white letters on blue, red and green translucent pushbuttons and black letters on white, yellow, orange and all filtered pushbuttons.



#### Legending

Pushbutton Size	Standard Pad Print Limitations
1/2 in square pushbuttons	2 lines, 4 characters per line
5/8 in square pushbuttons—full legend	3 lines, 6 characters per line
5/8 in square pushbuttons—split legend	2 lines, 6 characters per line
3/4 in square pushbuttons	3 lines, 7 characters per line
3/4 in x 1 in rectangular pushbutton—full legend	3 lines, 9 characters per line
3/4 in x 1 in rectangular pushbutton—split legend	2 lines, 9 characters per line

### Accessories

These snap-on pushbutton caps are made of molded plastic for use with grooved style switches. They are ordered separately for user assembly.



#### Snap-On Pushbutton Caps—Standard

Description	Button Diameter in Inches (mm)	Catalog Number
Black molded	0.625 (15.88)	<b>53-3338</b>
Red molded	0.625 (15.88)	<b>53-3338-2</b>

#### Notes

- ① The full guard barrier is molded as an integral part of the switch body and is specified as a part of the complete switch catalog number.
- ② An end barrier is attached to each side of housing. The center barrier is used between devices when gang mounting in a slot array.
- ③ For use with square devices and short side of rectangular devices.
- ④ For use with long side of rectangular devices. Use a center—long between switches if gang mounting.

Technical Data and Specifications

General Purpose Pushbuttons and Indicators—Illuminated and Non-Illuminated

Series	206/208	220/221/224	231/234	580/581/586
<b>Ratings—</b>				
<b>Silver Contacts</b>	5 A at 125 Vac or 250 Vac	5 A at 125 Vac or 250 Vdc	5 A at 125 Vac or 250 Vdc	Silver or Gold: 1 A at 125 Vac
<b>Gold Contacts</b>	0.1 A at 125 Vac/Vdc	0.1 A at 125 Vac/Vdc	0.1 A at 125 Vac/Vdc	Gold-plated contacts for low level
<b>Action</b>	Momentary Alternate with positive latch down	Momentary Alternate with positive latch down	Momentary Alternate with positive latch down	Momentary Alternate with positive latch down
<b>Switch Circuitry</b>	Break before make 1PDT or 2PDT 2-independent lamp circuits	Break before make 1PDT or 2PDT	Break before make 1PDT or 2PDT	Double break 1PST or 2PST
<b>Termination Types</b>	0.02 x 0.11 in (0.51 x 2.79 mm)	0.02 x 0.11 in (0.51 x 2.79 mm) <sup>①</sup>	0.02 x 0.110 in (0.51 x 2.79 mm) <sup>①</sup>	0.01 x 0.11 in (0.31 x 2.79 mm) <sup>①</sup>
<b>Pushbuttons</b>	0.62 x 1.00 in (15.87 x 25.40 mm) Rectangular Full or horizontal split lens Plain, engraved or hot stamped <sup>②</sup>	0.63 in (15.87 mm) Square Plain, engraved or hot stamped <sup>②</sup>	0.63 in (15.87 mm) Square Plain, engraved or hot stamped <sup>②</sup>	0.50 in (12.70 mm) Square 3 heights above panel E <sup>③</sup> Plain, engraved or hot stamped <sup>②</sup>
<b>Mounting</b>	Snap-in panel mounting Stainless steel retaining clips Panel thickness: 0.03 to 0.19 in (0.76 to 4.76 mm) Barrier mount available <sup>④</sup>	Snap-in panel mounting Stainless steel retaining clips Panel thickness: 0.03 to 0.19 in (0.76 to 4.76 mm) Barrier mount available <sup>④</sup>	Snap-in panel mounting Stainless steel retaining clips Panel thickness: 0.03 to 0.19 in (0.76 to 4.76 mm) Barrier mount available <sup>④</sup>	Snap-in panel mounting Choice of two bezel styles: Chamfered or Flat Stainless steel retaining clips Panel thickness: 0.06 to 0.19 in (1.59 to 4.76 mm)
<b>Lamps</b>	Two T 1-3/4 wedge base lamps Incandescent Front relampable Lamp stationary to reduce mechanical shock to filament	Two T 1-3/4 wedge base lamps Incandescent Front relampable Lamp stationary to reduce mechanical shock to filament	One rectangular LED flush with cap Various voltages available Diode protection available	Two T 1-3/4 wedge base lamps Incandescent Front relampable Lamp stationary to reduce mechanical shock to filament
<b>Pushbutton Travel</b>	0.19 in (2.29 mm)	0.19 in (2.29 mm)	0.19 in (2.29 mm)	0.17 in (4.32)

Series	770/775	810/815	820/825	860/861/845
<b>Ratings—</b>				
<b>Silver Contacts</b>	10.5 A at 125 Vac or 250 Vac	3 A at 125 Vac or 250 Vac	3 A at 125 Vac or 250 Vac	6 A at 125 Vac or 3 A at 250 Vac
<b>Gold Contacts</b>	0.25 A at 125 Vac or 30 Vdc	0.25 A at 125 Vac or 30 Vdc	0.25 A at 125 Vac or 30 Vdc	0.25 A at 125 Vac or 30 Vdc
<b>Action</b>	Momentary Alternate with positive latch down	Momentary Alternate with positive latch down	Momentary Alternate with positive latch down	Momentary Alternate with positive latch down
<b>Switch Circuitry</b>	1PDT or 2PDT (2 circuit) 2-independent lamp circuits	Break before make 1PDT or 2PDT	Break before make 1PDT or 2PDT	Double break 1PST or 2PST, NO
<b>Termination Types</b>	0.02 x 0.125 in (0.25 x 3.18 mm) <sup>①</sup> Epoxy sealed	0.02 x 0.11 in (0.64 x 2.79 mm) <sup>①</sup> Epoxy sealed	0.02 x 0.11 in (0.64 x 2.79 mm) <sup>①</sup> Epoxy sealed	0.02 x 0.11 in (0.64 x 2.79 mm) <sup>①</sup>
<b>Pushbuttons</b>	0.73 x 0.97 in (18.54 x 24.64 mm) Rectangular Plain, engraved or hot stamped <sup>②</sup>	0.75 x 1 in (19.05 x 25.40 mm) Rectangular 2 heights above panel <sup>③</sup> 5 styles Plain, engraved or hot stamped <sup>②</sup>	0.75 in (19.05 mm) Square 2 heights above panel <sup>③</sup> 5 styles Plain, engraved or hot stamped <sup>②</sup>	0.62 in (15.87 mm) Square Horizontal split legend (indicator only) 3 heights above bezel <sup>③</sup> 5 styles Plain, engraved or hot stamped <sup>②</sup>
<b>Mounting</b>	Panel mounting retained by molded sleeve and nut May be individually mounted or gang mounted in horizontal or vertical rows Panel thickness from 0.03 to 0.25 in (0.76 to 6.35 mm) Barrier mount available <sup>④</sup> Snap mount available	Snap-in panel mounting Stainless steel retaining clips Panel thickness: 0.06 to 0.19 in (1.59 to 4.76 mm) Barrier mount available <sup>④</sup>	Snap-in panel mounting Stainless steel retaining clips Panel thickness: 0.06 to 0.19 in (1.59 to 4.76 mm) Barrier mount available <sup>④</sup>	Snap-in panel mounting Stainless steel retaining clips Panel thickness: 0.06 to 0.19 in (1.59 to 4.76 mm) Barrier mount available <sup>④</sup>
<b>Lamps</b>	Accepts two T 1-3/4 midget flange base lamps Incandescent or neon Front relampable	One T 1-3/4 bi-pin base Incandescent, neon or LED Front relampable Lamp stationary to reduce mechanical shock to filament	One T 1-3/4 bi-pin base Incandescent, neon or LED Front relampable Lamp stationary to reduce mechanical shock to filament	One T 1-3/4 bi-pin base Incandescent, neon or LED Front relampable Lamp stationary to reduce mechanical shock to filament
<b>Pushbutton Travel</b>	0.22 in (5.59 mm)	0.22 in (5.59 mm)	0.22 in (5.59 mm)	0.22 in (5.59 mm)

Notes

- ① Terminations are suitable for solder or female 110 connectors. Series 770: Solder only.
- ② See Engraving and Hot Stamping table on **Page V11-T6-16** for more information.
- ③ See Product Selection tables on **Pages V11-T6-9–V11-T6-12** for more information.
- ④ See Series 200 and 300 Mounting Barriers table on **Page V11-T6-16** for more information.

# 6.2

## Pushbuttons

Illuminated AC/DC Rated

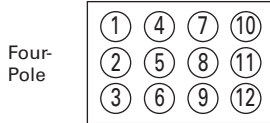
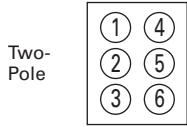
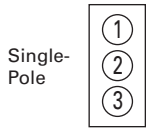

### Terminal Identification

When specified on order, switches will have the terminals identified as shown in the illustration at right. Terminal markings will be ink-stamped on the side of the switch case and unused terminal positions will not be identified.

All views are rear of switch with keyway or at down as applicable. Terminal numbers 2, 2 and 5 and 5 and 8 are considered inboard terminals for single-, two- and four-pole switches respectively. All others are considered outboard.

### Legends

#### Pushbutton Legend

Legend	Rocker Switch Type
●	Contact terminal—will make contact with switch lever
○	Isolated terminal—does not make contact with lever
⌋	Center terminal and switch lever
⊗	Bulb
↔	Momentary contact
●	Denotes mechanical contact portion

#### Notes

- ① Poles 11 and 12 may be eliminated for three-pole devices.
- ② Poles 10, 11 and 12 may be eliminated for three-pole devices.
- ③ Dependent lamp.
- ④ Independent lamp.
- ⑤ Two circuit—indicates a special type of double-throw switch in which the two circuits being controlled may be independent of each other.
- ⑥ For 206 Series, an additional lamp is available.
- ⑦ Available in 1PDT or 2PDT.

### Circuit Diagrams

#### Pushbutton Circuit Diagrams

Circuit Letter	Schematic	Circuit Letter	Schematic
<b>A</b> 1PST		<b>I</b> 2 circuit ⑤	
<b>B</b> 1PDT		<b>J</b> 1PST	
<b>C</b> 2PST		<b>K</b> 1PDT	
<b>D</b> 2PDT		<b>L</b> 2PST	
<b>E</b> 4PST ①		<b>M</b> 2PST	
<b>F</b> 4PDT ②		<b>N</b> ⑥ 2PDT	
<b>G</b> ③ 1PST		<b>P</b> 1PDT	
<b>H</b> ④ 1PDT		<b>Q</b> ⑦ 2 circuit	

**Dimensions**

Approximate Dimensions in Inches (mm)

**206 Series**

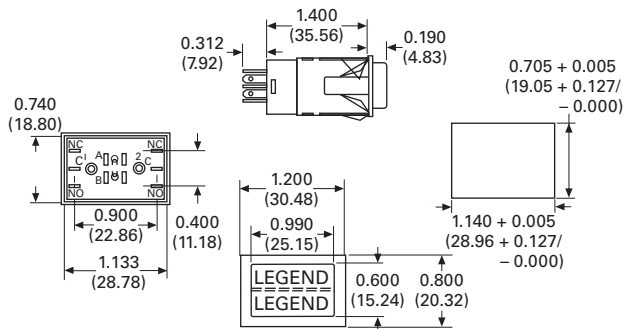

**580 Series**

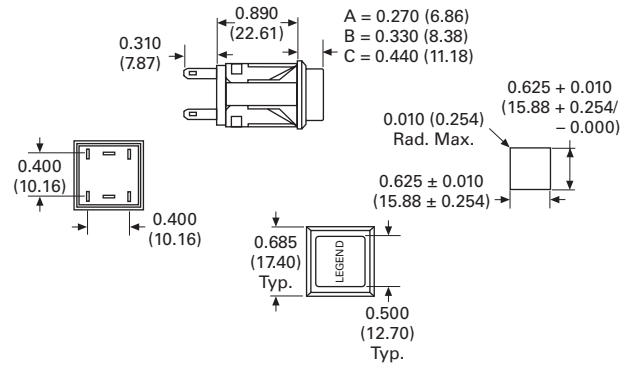

**220 Series**

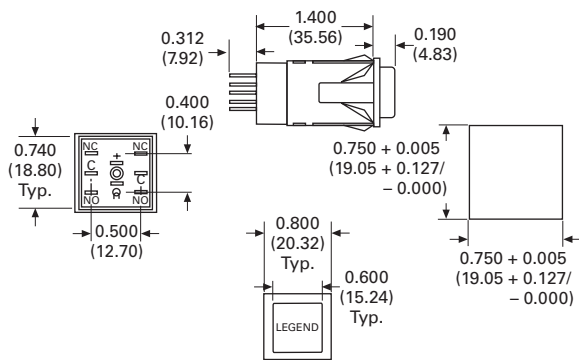

**770 Series**

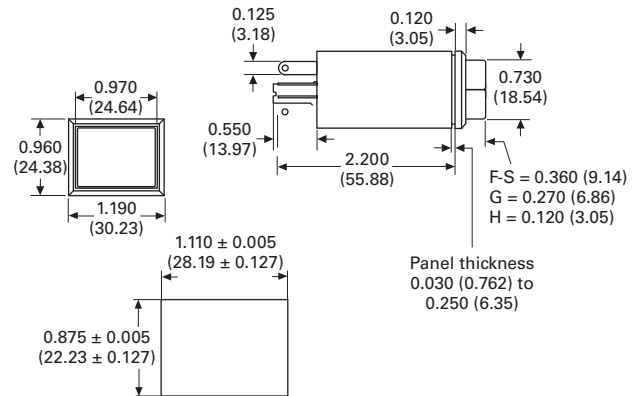

**231 Series**

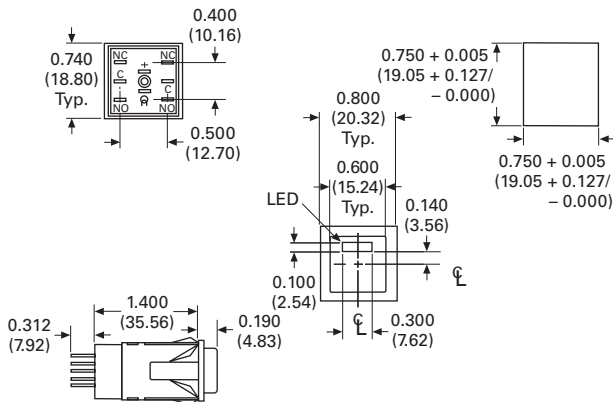

**810 Series**

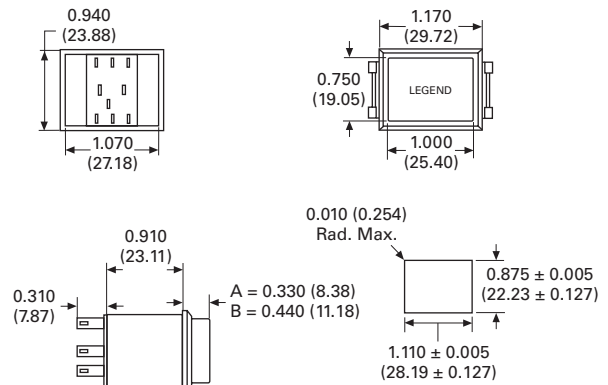

# 6.2

## Pushbuttons

Illuminated AC/DC Rated

Approximate Dimensions in Inches (mm)

### 820 Series

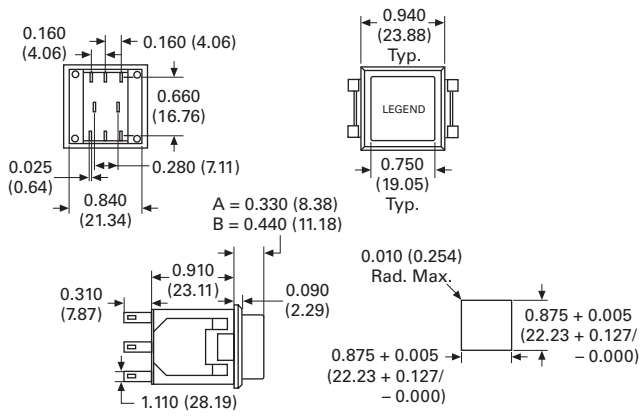

### 860 Series

