

Enhanced 50 Series Sensors



Contents

Description	Page
Enhanced 50 Series Sensors	
Product Selection	
Thru-Beam Sensors	V8-T5-10
Reflex Sensors	V8-T5-12
Diffuse Sensors	V8-T5-14
Clear Object Sensors	V8-T5-16
Fiber Optic Sensors	V8-T5-17
Compatible Connector Cables	V8-T5-19
Fiber Optic Cables	V8-T5-20
Accessories	V8-T5-21
Technical Data and Specifications	V8-T5-21
Excess Gain	V8-T5-22
Wiring Diagrams	V8-T5-23
Dimensions	V8-T5-24

Enhanced 50 Series Sensors

Product Description

The new Enhanced versions of the 50 Series™ Photoelectric Sensors from Eaton's Electrical Sector offer flexibility, durability and high optical performance in a cost-effective self-contained package. Choose from three output types, four time delay functions, six sensing modes and four connection styles to tailor the sensor to exactly meet your needs.

Sensors are available in thru-beam, reflex, polarized reflex, diffuse reflective, clear object, and fiber optic sensing modes. Brackets are available for easy mounting and to allow precise adjustment of sensor alignment.

Features

- High optical performance models including a 500 ft (152m) thru-beam and a 10 ft (3m) diffuse reflective unit
- Output options include a 3 Amp SPDT relay
- All units offer light/dark selection
- Logic options include ON-delay, OFF-delay, ON/OFF-delay and one-shot delay
- Fiber optic sensors operate in thru-beam or diffuse reflective mode depending on the fiber optic cable selected
- Fully potted construction for use in areas subject to washdown, high shock and/or vibration
- Choice of pre-wired power cable, built-in mini-connector, built-in micro-connector and pigtail micro-connector versions. Standard pre-wired cable length is 6 ft (2m)
- Variety of brackets available including ball swivel

Standards and Certifications

- CSA Approved
- Certified to UL Standard, UL 508



⚠ DANGER

THIS SENSOR IS NOT A SAFETY DEVICE AND IS NOT INTENDED TO BE USED AS A SAFETY DEVICE. This sensor is designed only to detect and read certain data in an electronic manner and perform no use apart from that, specifically no safety-related use. This sensor product does not include self-checking redundant circuitry, and the failure of this sensor product could cause either an energized or de-energized output condition, which could result in death, serious bodily injury, or property damage.

For the most current information on this product, visit our Web site: www.eaton.com

For Customer Service in the U.S. call 1-877-ETN CARE (386-2273), in Canada call 1-800-268-3578.
For Application Assistance in the U.S. and Canada call 1-800-426-9184.

5.1

Photoelectric Sensors

Enhanced 50 Series Sensors

Product Selection Guide

Connection Options

Cable Version



Mini QD (Body)



Micro or Euro (Micro) QD (Body)



Micro or Euro (Micro) QD (Pigtail)



5

Product Selection

Thru-Beam Sensors

Field of View: 2.4°



Thru-Beam Standard Range ①②

Voltage Range	Sensing Range	Optimum Range	Sensing Beam	Thru-Beam Component	Output Type	Time Delay	Connection Type	Catalog Number			
10–40 Vdc	200 ft (61m)	0.1 to 100 ft (0.03 to 31m)	Infrared	Source	N/A	N/A	6 ft cable	1150E-6517			
					Detector	NPN/PNP 250 mA		no	1250E-6517		
									yes		1250E-8517
				Source	N/A	N/A	4-pin Euro (micro) connector	1150E-6547 ☹			
					Detector	NPN/PNP 250 mA		no	1250E-6547 ☹		
									yes		1250E-8547 ☹
				Source	N/A	N/A	4-pin Euro (micro) connector (pigtail)	1150E-6537 ☹			
					Detector	NPN/PNP 250 mA		no	1250E-6537 ☹		
									yes		1250E-8537 ☹
				Source	N/A	N/A	4-pin mini-connector	1150E-6507 ☹			
					Detector	NPN/PNP 250 mA		no	1250E-6507 ☹		
									yes		1250E-8507 ☹
12–240 Vdc 24–240 Vac	200 ft (61m)	0.1 to 100 ft (0.03 to 31m)	Infrared	Source	N/A	N/A	6 ft cable	1150E-6513			
					Detector	Isolated output solid-state relay 300 mA at 240 Vac/dc		no	1250E-6513		
									yes		1250E-8513
				Source	N/A	N/A	4-pin micro-connector	1150E-6543 ☹			
					Detector	Isolated output solid-state relay 300 mA at 240 Vac/dc		no	1250E-6543 ☹		
									yes		1250E-8543 ☹
				Source	N/A	N/A	4-pin micro-connector (pigtail)	1150E-6534 ☹			
					Detector	Isolated output solid-state relay 300 mA at 240 Vac/dc		no	1250E-6533 ☹		
									yes		1250E-8533 ☹
				Source	N/A	N/A	5-pin micro-connector (pigtail)	1250E-6534 ☹			
					Detector	SPDT EM relay 3A at 120 Vac		no	1250E-8534 ☹		
									yes		1250E-8534 ☹
Source	N/A	N/A	4-pin mini-connector	1150E-6504 ☹							
	Detector	Isolated output solid-state relay 300 mA at 240 Vac/dc		no	1250E-6503 ☹						
					yes		1250E-8503 ☹				
Source	N/A	N/A	5-pin mini-connector	1250E-6504 ☹							
	Detector	SPDT EM relay 3A at 120 Vac		no	1250E-8504 ☹						
					yes		1250E-8504 ☹				

Notes

☹☹ See listing of compatible connector cables on **Page V8-T5-19**.

① For a complete system, order one sensor and one detector.

② For brackets compatible with these sensors, see Accessories on **Page V8-T5-21**.

Field of View: 2.4°



Thru-Beam Extended Range ①②

Voltage Range	Sensing Range	Optimum Range	Sensing Beam	Thru-Beam Component	Output Type	Time Delay	Connection Type	Catalog Number		
10–40 Vdc	500 ft (152m)	0.1 to 250 ft (0.03 to 77m)	Infrared	Source	N/A	N/A	6 ft cable	1151E-6517		
				Detector	NPN/PNP 250 mA	no		1251E-6517		
						yes		1251E-8517		
				Source	N/A	N/A	4-pin Euro (micro) connector	1151E-6547 ☹		
				Detector	NPN/PNP 250 mA	no		1251E-6547 ☹		
						yes		1251E-8547 ☹		
				Source	N/A	N/A	4-pin Euro (micro) connector (pigtail)	1151E-6537 ☹		
				Detector	NPN/PNP 250 mA	no		1251E-6537 ☹		
						yes		1251E-8537 ☹		
				Source	N/A	N/A	4-pin mini-connector	1151E-6507 ☹		
				Detector	NPN/PNP 250 mA	no		1251E-6507 ☹		
						yes		1251E-8507 ☹		
12–240 Vdc 24–240 Vac	500 ft (152m)	0.1 to 250 ft (0.03 to 77m)	Infrared	Source	N/A	N/A	6 ft cable	1151E-6513		
				Detector	Isolated output solid-state relay 300 mA at 240 Vac/dc	no		1251E-6513		
						yes		1251E-8513		
								SPDT EM relay 3A at 120 Vac	no	1251E-6514
						yes		1251E-8514		
				Source	N/A	N/A		4-pin micro-connector	1151E-6543 ☹	
				Detector	Isolated output solid-state relay 300 mA at 240 Vac/dc	no	1251E-6543 ☹			
						yes	1251E-8543 ☹			
				Source	N/A	N/A	4-pin micro-connector (pigtail)	1151E-6534 ☹		
				Detector	Isolated output solid-state relay 300 mA at 240 Vac/dc	no		1251E-6533 ☹		
						yes		1251E-8533 ☹		
							5-pin micro-connector (pigtail)	SPDT EM relay 3A at 120 Vac	no	1251E-6534 ☹
		yes	1251E-8534 ☹							
Source	N/A	N/A	4-pin mini-connector	1151E-6504 ☹						
Detector	Isolated output solid-state relay 300 mA at 240 Vac/dc	no		1251E-6503 ☹						
		yes		1251E-8503 ☹						
			5-pin mini-connector	SPDT EM relay 3A at 120 Vac	no	1251E-6504 ☹				
		yes		1251E-8504 ☹						

Notes

☹☹ See listing of compatible connector cables on **Page V8-T5-19**.

① For a complete system, order one sensor and one detector.

② For brackets compatible with these sensors, see Accessories on **Page V8-T5-21**.

5.1

Photoelectric Sensors

Enhanced 50 Series Sensors

Reflex Sensors

Field of View: 1.0°



Standard Reflex ^{①②}

Voltage Range	Sensing Range ^③	Optimum Range ^③	Sensing Beam	Output Type	Time Delay	Connection Type	Catalog Number					
10–40 Vdc	30 ft (9m)	0.5 to 15 ft (0.2 to 4.6m)	Visible red	NPN/PNP 250 mA	no	6 ft cable	1450E-6517					
					yes		1450E-8517					
					no	4-pin Euro (micro) connector	1450E-6547 ☹					
					yes		1450E-8547 ☹					
					no	4-pin Euro (micro) connector (pigtail)	1450E-6537 ☹					
					yes		1450E-8537 ☹					
					no	4-pin mini-connector	1450E-6507 ☹					
					yes		1450E-8507 ☹					
					12–240 Vdc 24–240 Vac	30 ft (9m)	0.5 to 15 ft (0.2 to 4.6m)	Visible red	Isolated output solid-state relay 300 mA at 240 Vac/dc	no	6 ft cable	1450E-6513
										yes		1450E-8513
										no	4-pin micro-connector	1450E-6543 ☹
										yes		1450E-8543 ☹
										no	4-pin micro-connector (pigtail)	1450E-6533 ☹
									yes		1450E-8533 ☹	
no	4-pin mini-connector	1450E-6503 ☹										
yes		1450E-8503 ☹										
SPDT EM relay 3A at 120 Vac	no	6 ft cable	1450E-6514									
	yes		1450E-8514									
	no	5-pin micro-connector (pigtail)	1450E-6534 ☹									
	yes		1450E-8534 ☹									
	no	5-pin mini-connector	1450E-6504 ☹									
yes		1450E-8504 ☹										

Notes

☹☹ See listing of compatible connector cables on **Page V8-T5-19**.

① For a complete system, order one sensor and one retroreflector (see **Tab 8, section 8.1**).

② For brackets compatible with these sensors, see Accessories on **Page V8-T5-21**.

③ Ranges based on 3 in retroreflector for reflex sensors.

Field of View: 1.0°



Polarized Reflex ①②③

Voltage Range	Sensing Range ④	Optimum Range ④	Sensing Beam	Output Type	Time Delay	Connection Type	Catalog Number					
10–40 Vdc	16 ft (4.9m)	0.5 to 8 ft (0.2 to 2.5m)	Visible red	NPN/PNP 250 mA	no	6 ft cable	1451E-6517					
							yes	1451E-8517				
					no	4-pin Euro (micro) connector	1451E-6547 Ⓢ					
							yes	1451E-8547 Ⓢ				
					no	4-pin Euro (micro) connector (pigtail)	1451E-6537 Ⓢ					
							yes	1451E-8537 Ⓢ				
					no	4-pin mini-connector	1451E-6507 Ⓢ					
							yes	1451E-8507 Ⓢ				
					12–240 Vdc 24–240 Vac	16 ft (4.9m)	0.5 to 8 ft (0.2 to 2.5m)	Visible red	Isolated output solid-state relay 300 mA at 240 Vac/dc	no	6 ft cable	1451E-6513
												yes
										no	4-pin micro-connector	1451E-6543 Ⓢ
												yes
										no	4-pin micro-connector (pigtail)	1451E-6533 Ⓢ
												yes
no	4-pin mini-connector	1451E-6503 Ⓢ										
		yes	1451E-8503 Ⓢ									
SPDT EM relay 3A at 120 Vac										no	6 ft cable	1451E-6514
												yes
										no	5-pin micro-connector (pigtail)	1451E-6534 Ⓢ
												yes
										no	5-pin mini-connector	1451E-6504 Ⓢ
												yes

Notes

- ⓈⓈ See listing of compatible connector cables on **Page V8-T5-19**.
- ① For a complete system, order one sensor and one retroreflector (see **Tab 8, section 8.1**).
- ② Polarized sensors may not operate with reflective tape. Test tape selection before installation.
- ③ For brackets compatible with these sensors, see Accessories on **Page V8-T5-21**.
- ④ Ranges based on 3 in retroreflector for reflex sensors.

5.1

Photoelectric Sensors

Enhanced 50 Series Sensors

Diffuse Sensors

Field of View: 2.8°



Diffuse Reflective ①

Voltage Range	Sensing Range ②	Optimum Range ②	Sensing Beam	Output Type	Time Delay	Connection Type	Catalog Number				
10–40 Vdc	5 ft (1.5m)	1 to 30 in (25 to 760 mm)	Infrared	NPN/PNP 250 mA	no	6 ft cable	1350E-6517				
					yes		1350E-8517				
					no	4-pin Euro (micro) connector	1350E-6547 ☹				
					yes		1350E-8547 ☹				
					no	4-pin Euro (micro) connector (pigtail)	1350E-6537 ☹				
					yes		1350E-8537 ☹				
				no	4-pin mini-connector	1350E-6507 ☹					
				yes		1350E-8507 ☹					
				12–240 Vdc 24–240 Vac	5 ft (1.5m)	1 to 30 in (25 to 760 mm)	Infrared	Isolated output solid-state relay 300 mA at 240 Vac/dc	no	6 ft cable	1350E-6513
									yes		1350E-8513
								no	4-pin micro-connector	1350E-6543 ☹	
								yes		1350E-8543 ☹	
								no	4-pin micro-connector (pigtail)	1350E-6533 ☹	
								yes		1350E-8533 ☹	
no	4-pin mini-connector	1350E-6503 ☹									
yes		1350E-8503 ☹									
				SPDT EM relay 3A at 120 Vac	no	6 ft cable	1350E-6514				
					yes		1350E-8514				
				no	5-pin micro-connector (pigtail)	1350E-6534 ☹					
				yes		1350E-8534 ☹					
				no	5-pin mini-connector	1350E-6504 ☹					
				yes		1350E-8504 ☹					

Notes

☹☹ See listing of compatible connector cables on **Page V8-T5-19**.

① For brackets compatible with these sensors, see Accessories on **Page V8-T5-21**.

② Ranges based on 90% reflectance white card for diffuse reflective sensors.

Field of View: 2.8°



Diffuse Reflective Extended Range ①

Voltage Range	Sensing Range ②	Optimum Range ②	Sensing Beam	Output Type	Time Delay	Connection Type	Catalog Number					
10–40 Vdc	10 ft (3m)	1 to 60 in (25 to 1520 mm)	Infrared	NPN/PNP 250 mA	no	6 ft cable	1351E-6517					
							yes	1351E-8517				
					no	4-pin Euro (micro) connector	1351E-6547 ☹️					
							yes	1351E-8547 ☹️				
					no	4-pin Euro (micro) connector (pigtail)	1351E-6537 ☹️					
							yes	1351E-8537 ☹️				
					no	4-pin mini-connector	1351E-6507 ☹️					
							yes	1351E-8507 ☹️				
					12–240 Vdc 24–240 Vac	10 ft (3m)	1 to 60 in (25 to 1520 mm)	Infrared	Isolated output solid-state relay 300 mA at 240 Vac/dc	no	6 ft cable	1351E-6513
												yes
										no	4-pin micro-connector	1351E-6543 ☹️
												yes
										no	4-pin micro-connector (pigtail)	1351E-6533 ☹️
												yes
no	4-pin mini-connector	1351E-6503 ☹️										
		yes	1351E-8503 ☹️									
SPDT EM relay 3A at 120 Vac										no	6 ft cable	1351E-6514
												yes
										no	5-pin micro-connector (pigtail)	1351E-6534 ☹️
												yes
										no	5-pin mini-connector	1351E-6504 ☹️
												yes

Notes

☹️☹️ See listing of compatible connector cables on **Page V8-T5-19**.

① For brackets compatible with these sensors, see Accessories on **Page V8-T5-21**.

② Ranges based on 90% reflectance white card for diffuse reflective sensors.

5.1

Photoelectric Sensors

Enhanced 50 Series Sensors

Clear Object Sensors

Field of View: 0.68°



Clear Object Detector ^{①②}

Voltage Range	Sensing Range	Optimum Range	Sensing Beam	Output Type	Time Delay	Connection Type	Catalog Number					
10–40 Vdc	45 in (1.2m)	1 to 24 in (25 to 610 mm)	Visible red	NPN/PNP 250 mA	no	6 ft cable	1452E-6517					
					yes		1452E-8517					
					no	4-pin Euro (micro) connector	1452E-6547 ☹					
					yes		1452E-8547 ☹					
					no	4-pin Euro (micro) connector (pigtail)	1452E-6537 ☹					
					yes		1452E-8537 ☹					
					no	4-pin mini-connector	1452E-6507 ☹					
					yes		1452E-8507 ☹					
					12–240 Vdc 24–240 Vac	45 in (1.2m)	1 to 24 in (25 to 610 mm)	Visible red	Isolated output solid-state relay 300 mA at 240 Vac/dc	no	6 ft cable	1452E-6513
										yes		1452E-8513
no	4-pin micro-connector	1452E-6543 ☹										
yes		1452E-8543 ☹										
no	4-pin micro-connector (pigtail)	1452E-6533 ☹										
yes		1452E-8533 ☹										
no	4-pin mini-connector	1452E-6503 ☹										
yes		1452E-8503 ☹										
SPDT EM relay 3A at 120 Vac										no	6 ft cable	1452E-6514
										yes		1452E-8514
					no	5-pin micro-connector (pigtail)	1452E-6534 ☹					
					yes		1452E-8534 ☹					
					no	5-pin mini-connector	1452E-6504 ☹					
					yes		1452E-8504 ☹					

Notes

☹☹ See listing of compatible connector cables on **Pages V8-T5-19** and **V8-T5-20**.

① For a complete system, order one sensor and one retroreflector (see **Tab 8, section 8.1**).

② For brackets compatible with these sensors, see Accessories on **Page V8-T5-21**.

Fiber Optic Sensors

Field of View: ②③④



Fiber Optic Infrared ①

Voltage Range	Sensing Range	Optimum Range	Sensing Beam	Output Type	Time Delay	Connection Type	Catalog Number					
10–40 Vdc	Depends on fiber selected ⑤	Depends on fiber selected	Infrared	NPN/PNP 250 mA	no	6 ft cable	1550E-6517					
					yes		1550E-8517					
					no	4-pin Euro (micro) connector	1550E-6547 ②					
					yes		1550E-8547 ②					
					no	4-pin Euro (micro) connector (pigtail)	1550E-6537 ②					
					yes		1550E-8537 ②					
					no	4-pin mini-connector	1550E-6507 ②					
					yes		1550E-8507 ②					
					12–240 Vdc 24–240 Vac	Depends on fiber selected ⑤	Depends on fiber selected	Infrared	Isolated output solid-state relay 300 mA at 240 Vac/dc	no	6 ft cable	1550E-6513
										yes		1550E-8513
										no	4-pin micro-connector	1550E-6543 ②
										yes		1550E-8543 ②
no	4-pin micro-connector (pigtail)	1550E-6533 ②										
yes		1550E-8533 ②										
no	4-pin mini-connector	1550E-6503 ②										
yes		1550E-8503 ②										
SPDT EM relay 3A at 120 Vac										no	6 ft cable	1550E-6514
										yes		1550E-8514
										no	5-pin micro-connector (pigtail)	1550E-6534 ②
										yes		1550E-8534 ②
					no	5-pin mini-connector	1550E-6504 ②					
					yes		1550E-8504 ②					

Notes

- ②③④ See listing of compatible connector cables on **Pages V8-T5-19** and **V8-T5-20**.
- ① For brackets compatible with these sensors, see **Accessories** on **Page V8-T5-21**.
- ② Field of view depends on fiber selected.
- ③ For a complete system, order one sensor and one fiber optic cable (see **Pages V8-T5-19** and **V8-T5-20**).
- ④ Infrared fiber optic sensors are compatible with glass fiber optic cables (E51KE_).
- ⑤ Diffuse mode—up to 6 in (152 mm); thru-beam—up to 35 in (890 mm).

5.1

Photoelectric Sensors

Enhanced 50 Series Sensors

Field of View: ②③④



Fiber Optic Visible ①

Voltage Range	Sensing Range	Optimum Range	Sensing Beam	Output Type	Time Delay	Connection Type	Catalog Number				
10–40 Vdc	Depends on fiber selected ⑤	Depends on fiber selected	Infrared	NPN/PNP 250 mA	no	6 ft cable	1551E-6517				
					yes		1551E-8517				
					no	4-pin Euro (micro) connector	1551E-6547 ☹				
					yes		1551E-8547 ☹				
					no	4-pin Euro (micro) connector (pigtail)	1551E-6537 ☹				
					yes		1551E-8537 ☹				
				no	4-pin mini-connector	1551E-6507 ☹					
				yes		1551E-8507 ☹					
				12–240 Vdc 24–240 Vac	Depends on fiber selected ⑤	Depends on fiber selected	Infrared	Isolated output solid-state relay 300 mA at 240 Vac/dc	no	6 ft cable	1551E-6513
									yes		1551E-8513
									no	4-pin micro-connector	1551E-6543 ☹
								yes		1551E-8543 ☹	
no	4-pin micro-connector (pigtail)	1551E-6533 ☹									
yes		1551E-8533 ☹									
SPDT EM relay 3A at 120 Vac					no	6 ft cable	1551E-6514				
					yes		1551E-8514				
					no	5-pin micro-connector (pigtail)	1551E-6534 ☹				
				yes		1551E-8534 ☹					
				no	5-pin mini-connector	1551E-6504 ☹					
				yes		1551E-8504 ☹					

Notes



- ☹☹ See listing of compatible connector cables on **Page V8-T5-19**.
- ① For brackets compatible with these sensors, see Accessories on **Page V8-T5-21**.
- ② Field of view depends on fiber selected.
- ③ For a complete system, order one sensor and one fiber optic cable (see **Page V8-T5-20**).
- ④ Visible fiber optic sensors are compatible with plastic fiber optic cables only.
- ⑤ Diffuse mode—up to 3 in (76 mm); thru-beam—up to 35 in (890 mm).

Compatible Connector Cables

Micro-Style,
Straight Female





Standard Cables—Micro ①

Voltage Style	Number of Pins	Gauge	Length	Pin Configuration/ Wire Colors (Face View Female Shown)	PVC Jacket Catalog Number	PUR Jacket Catalog Number	IRR PUR Jacket Catalog Number
Micro-Style, Straight Female							
AC Micro	4-pin, 4-wire	22 AWG	6 ft (2m)	 1-Red/Black 2-Red/White 3-Red 4-Green	CSAS4F4CY2202	CSAS4F4RY2202	CSAS4F4IO2202
	5-pin, 5-wire	22 AWG	6 ft (2m)	 1-Brown 2-White 3-Black 4-Gray 5-Blue	CSAS5A5CY2202	—	—
DC	4-pin, 4-wire	22 AWG	6 ft (2m)	 1-Brown 2-White 3-Blue 4-Black	CSDS4A4CY2202	CSDS4A4RY2202	CSDS4A4IO2202

Mini-Style,
Straight Female



Standard Cables—Mini ①

Current Rating at 600V	Voltage Style	Number of Pins	Gauge	Length	Pin Configuration/ Wire Colors (Face View Female Shown)	Catalog Number
Mini-Style, Straight Female						
8A	AC/DC	4-pin, 4-wire	16 AWG	6 ft (2m)	 1-Black 2-Blue 3-Brown 4-White	CSMS4A4CY1602
		5-pin, 5-wire	16 AWG	6 ft (2m)	 1-Black 2-Blue 3-Orange 4-Brown 5-White	CSMS5A5CY1602

Note

① For a full selection of connector cables, see **Tab 10, section 10.1**.

5.1

Photoelectric Sensors

Enhanced 50 Series Sensors

5

Fiber Optic Cables





Glass Fiber Optic Cables

Glass Fiber Optic Cables—Duplex Cables (for Diffuse Reflective Sensing)

Sensing Tip Style	Fiber Bundle Size A in In (mm)	Stainless Steel Jacket Catalog Number	PVC/Monocoil Jacket Catalog Number
	Forward Viewing, Unthreaded		
	0.125 (3.2)	E51KE713	E51KE313
	Right Angle Viewing, Unthreaded		
	0.125 (3.2)	E51KE733	E51KE333
	Forward Viewing, Threaded Cable End		
	0.125 (3.2)	E51KE723	E51KE323
	Right Angle Viewing, Threaded Cable Shaft		
	0.125 (3.2)	E51KE7A3	E51KE3A3
	Right Angle Viewing, Threaded Cable End		
	0.125 (3.2)	E51KE7B3	E51KE3B3

Dimensions, see Page V8-T5-25.



Glass Fiber Optic Cables—Single Cables (for Thru-Beam Sensing)

Sensing Tip Style	Fiber Bundle Size A in In (mm)	Stainless Steel Jacket Catalog Number	PVC/Monocoil Jacket Catalog Number
	Forward Viewing, Unthreaded		
	0.125 (3.2)	E51KE813	E51KE413
	Right Angle Viewing, Unthreaded		
	0.125 (3.2)	E51KE833	E51KE433
	Forward Viewing, Threaded Cable End		
	0.125 (3.2)	E51KE823	E51KE423
	Right Angle Viewing, Threaded Cable Shaft		
	0.125 (3.2)	E51KE8A3	E51KE4A3
	Right Angle Viewing, Threaded Cable End		
	0.125 (3.2)	E51KE8B3	E51KE4B3

Dimensions, see Page V8-T5-25.

Plastic Fiber Optic Cables

Plastic Fiber Optic Cables—Pre-Assembled Duplex Cables



Sensing Tip Style	Fiber Diameter in In (mm)	Catalog Number
	Large Diameter, Threaded Tip	
	0.059 (1.5)	6324E-6501 ^{①②}
	Large Diameter, Threaded Tip with Bendable Probe	
	0.039 (1.0)	6324E-6502 ^②

Dimensions, see Page V8-T5-25.

Notes

- ① Larger diameter (1.5 mm) fibers provide approximately 50% longer sensing range than small diameter (1 mm).
- ② One cable.
- ③ Set of two.

Plastic Fiber Optic Cables—Pre-Assembled Single Cables

Sensing Tip Style	Fiber Diameter in In (mm)	Catalog Number
	Large Diameter, Threaded Tip	
	0.059 (1.5)	6323E-6501 ^{①③}
	Large Diameter, Threaded Tip with Bendable Probe	
	0.039 (1.0)	6323E-6502 ^③

Dimensions, see Page V8-T5-25.

Accessories

Enhanced 50 Series Sensors

	Description	Catalog Number
 <p>Mounting Bracket Right Angle—Short</p>	<p>Mounting Bracket Right Angle—Short</p> <p>Provides for full 360° rotation of sensor. Bracket slots allow for up to 1.5 in of vertical adjustment. Nickel plated</p>	6150E-6501
	<p>Mounting Bracket Right Angle—Tall</p> <p>Provides for full 360° rotation of sensor. Bracket slots allow for up to 1.5 in of vertical adjustment in each slot, and 3.5 in of overall positioning adjustment.</p>	6150E-6502
	<p>Mounting Bracket Right Angle—Ball Swivel</p> <p>Provides for full 360° rotation of sensor. Ball swivel allows for ±30° sensor angle.</p>	6150E-6503
	<p>Retroreflectors</p> <p>Retroreflectors and retroreflective tape, see Tab 8, section 8.1</p>	—
	<p>Connector Cables</p> <p>For use with connector version sensors, see Tab 10, section 10.1</p>	—
	<p>Dimensions, see Page V8-T5-25.</p>	

Technical Data and Specifications

Enhanced 50 Series Sensors

Description	AC/DC EM Relay Model Specification	AC/DC Solid-state Relay Model Specification	DC Only Standard Range Model Specification	DC Only Extended Range Model Specification
Input voltage	12–240 Vdc; 24–240 Vac	12–240 Vdc; 24–240 Vac	10–40 Vdc	10–40 Vdc
Light/dark operation	Switch selectable	Switch selectable	Switch selectable	Switch selectable
Operating temperature	–13° to 131°F (–25° to 55°C)	–13° to 131°F (–25° to 55°C)	–13° to 131°F (–25° to 55°C)	–13° to 131°F (–25° to 55°C)
Humidity	95% Relative humidity, non-condensing	95% Relative humidity, non-condensing	95% Relative humidity, non-condensing	95% Relative humidity, non-condensing
Case material	Fiberglass reinforced plastic	Fiberglass reinforced plastic	Fiberglass reinforced plastic	Fiberglass reinforced plastic
Lens material	Acrylic	Acrylic	Acrylic	Acrylic
Vibration	IEC 60947-5-2 part 7.4.2	IEC 60947-5-2 part 7.4.2	IEC 60947-5-2 part 7.4.2	IEC 60947-5-2 part 7.4.2
Shock	IEC 60947-5-2 part 7.4.1	IEC 60947-5-2 part 7.4.1	IEC 60947-5-2 part 7.4.1	IEC 60947-5-2 part 7.4.1
Protection	Output short circuit and overcurrent protection Reverse polarity protection	Output short circuit and overcurrent protection Reverse polarity protection	Output short circuit and overcurrent protection Reverse polarity protection	Output short circuit and overcurrent protection Reverse polarity protection
Enclosure ratings	IP67, IP69K	IP67, IP69K	IP67, IP69K	IP67, IP69K
Output load	3A at 120 Vac; 3A at 240 Vac 3A at 28 Vac	300 mA at 240 Vac/dc	250 mA at 40 Vdc	250 mA at 40 Vdc
Response time	15 ms	2 ms	2 ms	2 ms
Timer timing response	0–15 sec.	0–15 sec.	0–15 sec.	0–15 sec.
No load current	<30 mA	<30 mA	<30 mA	<30 mA
Leakage current (max.)	—	1 mA at 240 Vac	<10 µA	<10 µA
Indicator LEDs	Green: output; yellow: power; red: alignment	Green: output; yellow: power; red: alignment	Green: output; yellow: power; red: alignment	Green: output; yellow: power; red: alignment
Emitter LED				
Diffuse, infrared fiber optic, thru-beam models	Infrared 880 mm	Infrared 880 mm	Infrared 880 mm	Infrared 880 mm
Reflex, polarized reflex, clear object, visible fiber optic units	Visible red 660 mm	Visible red 660 mm	Visible red 660 mm	Visible red 660 mm

5.1

Photoelectric Sensors

Enhanced 50 Series Sensors

5

Excess Gain

Thru-Beam

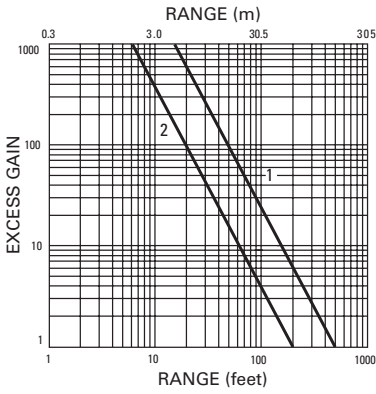

Thru-beam
 1. 1151E/1251E
 2. 1150E/1250E

Clear Object Detector

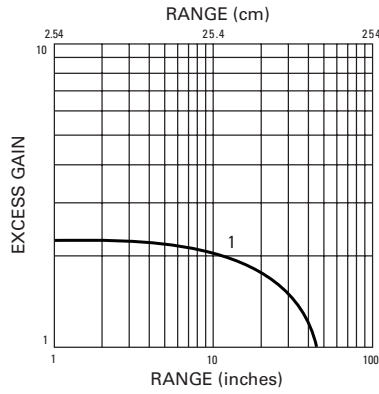

Clear object detector
 3 in retroreflector
 1. 1452E

Diffuse Reflective

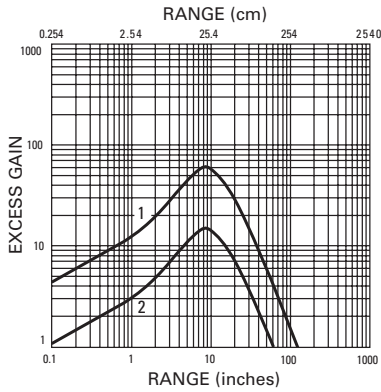

Diffuse reflective
 90% reflectance white card
 1. 1351E
 2. 1350E

Fiber Optic Diffuse

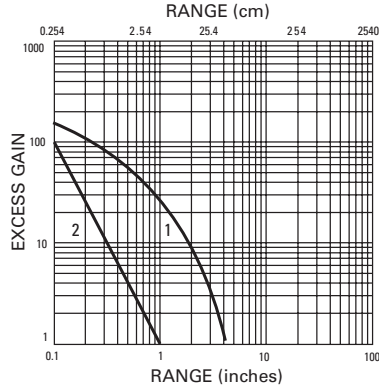

Fiber optic diffuse
 0.125 in dia. glass fiber 0.040 in dia. plastic fiber
 1. 1550E 2. 1551E

Reflex

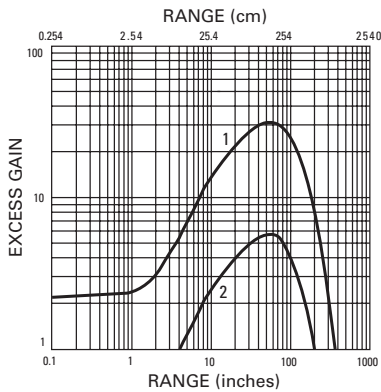

Reflex
 3 in retroreflector
 1. 1450E
 2. 1451E

Fiber Optic Thru-Beam

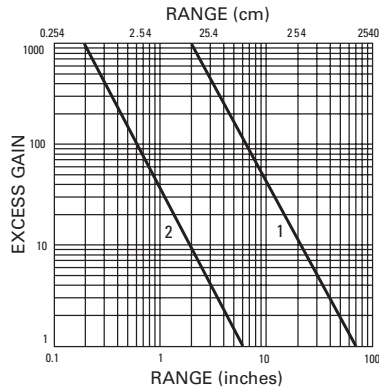

Fiber optic thru-beam
 0.125 in dia. glass fiber 0.040 in dia. plastic fiber
 1. 1550E 2. 1551E

Wiring Diagrams

Pin numbers are for reference, rely on pin location when wiring.

Enhanced 50 Series Sensors

Operating Voltage	Cable Model	Mini-Connector Model (Face View Male Shown)	Micro-Connector Model (Face View Male Shown)
Thru-Beam Source			
10–40 Vdc			
All Others			
10–40 Vdc			
Thru-Beam Source			
12–240 Vdc or 24–240 Vac solid-state relay ^②			
All Others with Isolated AC/DC Output			
12–240 Vdc or 24–240 Vac solid-state relay ^②			
Thru-Beam Source			
12–240 Vdc or 24–240 Vac SPDT EM relay ^②			
All Others			
12–240 Vdc or 24–240 Vac SPDT EM relay ^②			

Notes

- ① Connecting the test input to 0 Vdc allows you to switch the light source off for troubleshooting while leaving the sensor under power.
- ② Over current protection is to be provided in the field. Conductor size for 20 AWG: 5 amp; 22 AWG: 3 amp; 24 AWG: 2 amp.
- ③ Connect load to appropriate output for either sinking or sourcing operation.

5.1

Photoelectric Sensors

Enhanced 50 Series Sensors

Dimensions

Approximate Dimensions in Inches (mm)

Enhanced 50 Series Sensors

Cable and Pigtail Connector Versions

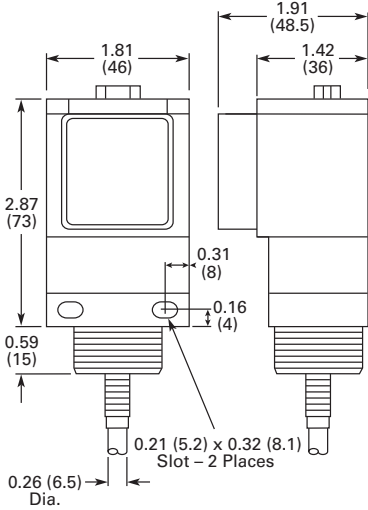

Mini-Connector Versions

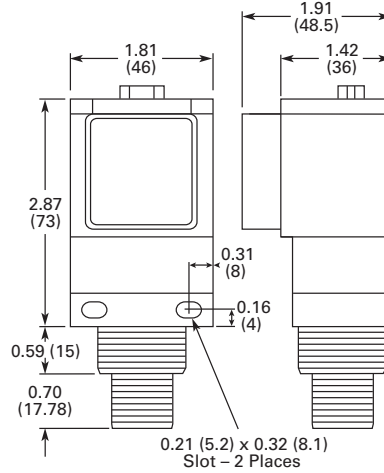

Clear Object Versions

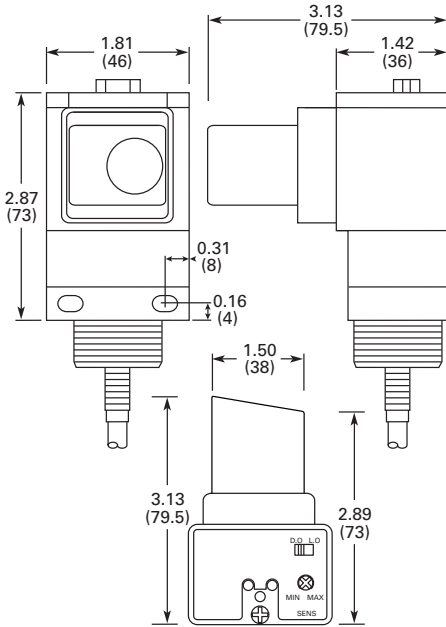

AC/DC Micro or Euro (Micro) Connector Versions

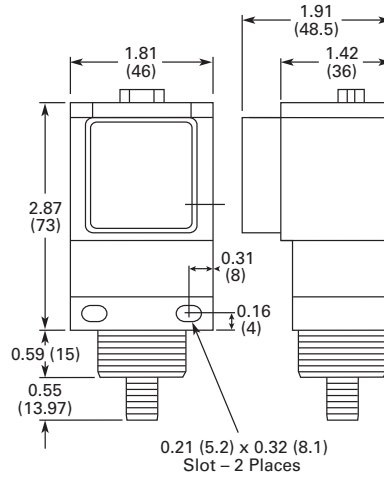

Top Views

With Timing

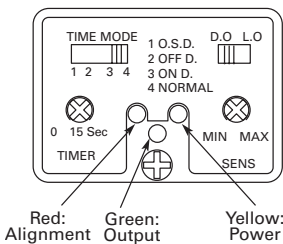

Without Timing

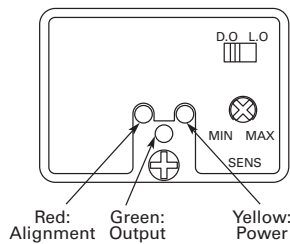

Approximate Dimensions in Inches (mm)

Glass Fiber Optic Cables—Duplex Cables

Stainless Steel Jacket shown for all.

Collar Mounting End

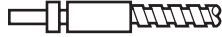

Forward Viewing, Unthreaded

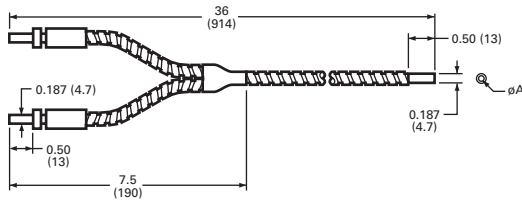

Right Angle Viewing, Unthreaded

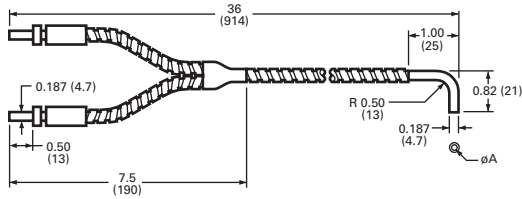

Forward Viewing, Threaded Cable End

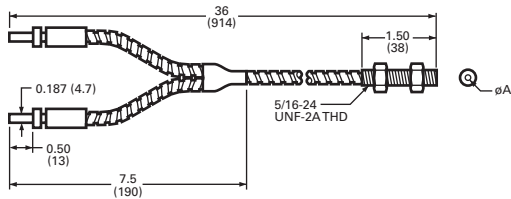

Right Angle Viewing, Threaded Cable Shaft

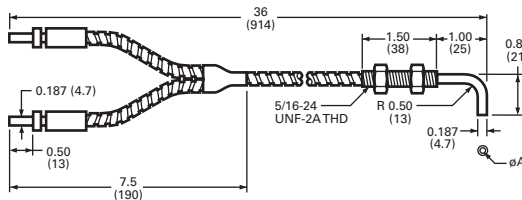

Right Angle Viewing, Threaded Cable End

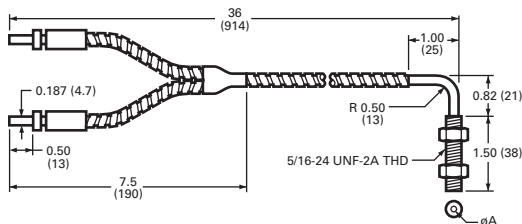

Glass Fiber Optic Cables—Single Cables

Stainless Steel Jacket shown for all.

Collar Mounting End

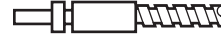

Forward Viewing, Unthreaded

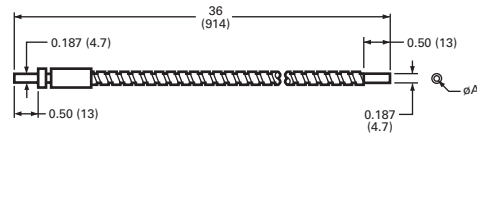

Right Angle Viewing, Unthreaded

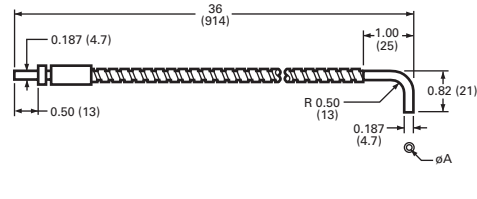

Forward Viewing, Threaded Cable End

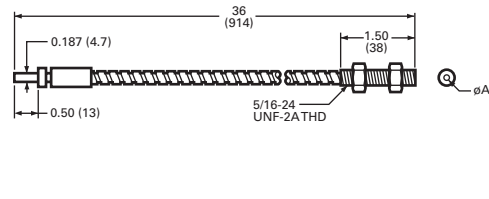

Right Angle Viewing, Threaded Cable Shaft

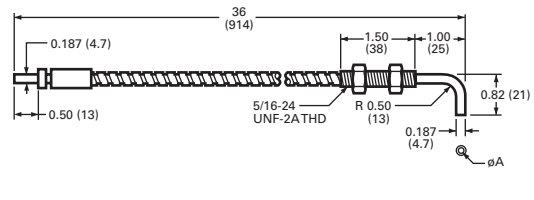

Right Angle Viewing, Threaded Cable End

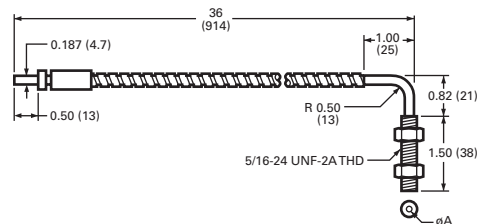

5.1

Photoelectric Sensors

Enhanced 50 Series Sensors

Approximate Dimensions in Inches (mm)

Plastic Fiber Optic Cables—Pre-Assembled Duplex Cables

Large Diameter, Threaded Tip

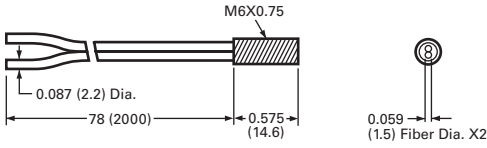

Plastic Fiber Optic Cables—Pre-Assembled Single Cables

Large Diameter, Threaded Tip

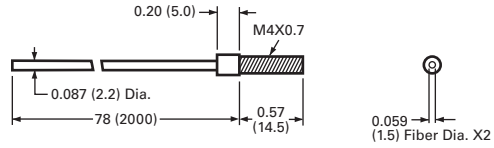

Large Diameter, Threaded Tip with Bendable Probe

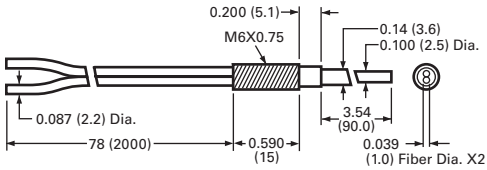

Large Diameter, Threaded Tip with Bendable Probe

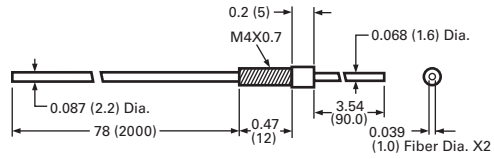

Accessories

Mounting Bracket Right Angle—Short

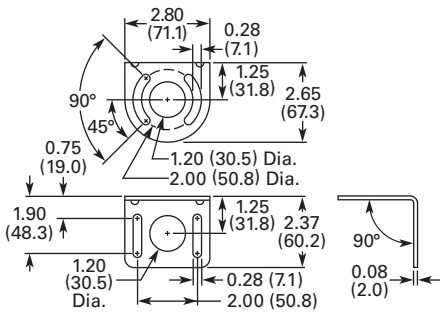

Mounting Bracket Right Angle—Ball Swivel

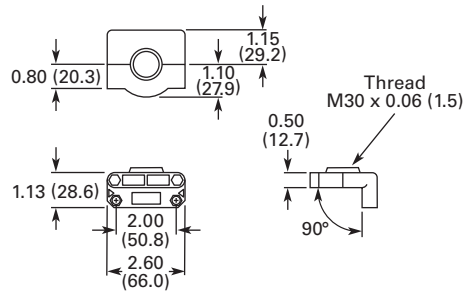

Mounting Bracket Right Angle—Tall

