

COMPACT INDUSTRIAL GEARBOXES

ATEX CATALOGUE



INDICE

INDEX

	pag. page		pag. page
1. INTRODUZIONE	2	1. INTRODUCTION	2
1.1. LE DIRETTIVE ATEX	2	1.1. THE ATEX DIRECTIVES	2
1.2. LINKS UTILI	4	1.2. USEFUL LINKS	4
2. DESCRIZIONE RIDUTTORI	5	2. DESCRIPTION OF GEARBOXES	5
2.1. USO PREVISTO	8	2.1. PROPER USE.....	8
2.2. DATI DI SELEZIONE DEL RIDUTTORE	8	2.2. DATA NEEDED TO SELECT A GEARBOX.....	8
2.3. TARGHETTA DI IDENTIFICAZIONE	9	2.3. IDENTIFICATION PLATE.....	9
3. DESCRIZIONI TECNICHE	10	3. TECHNICAL DEFINITIONS	10
3.1. SELEZIONE RIDUTTORE	11	3.1. SELECTING THE RIGHT GEARBOX	11
4. DATI TECNICI E TAVOLE DIMENSIONALI	14-27	4. TECHNICAL SPECIFICATIONS AND DIMENSION TABLES	14-27
5. STATO DI FORNITURA	28	5. DELIVERY STATE	28





1. INTRODUZIONE

1.1. LE DIRETTIVE ATEX

Alcuni processi di lavorazione avvengono in presenza di gas o di polveri che, in particolari condizioni, possono esplodere o bruciare provocando gravi danni a persone e cose.

Poiché, nella maggior parte dei casi, non è possibile isolare le apparecchiature dall'atmosfera potenzialmente esplosiva, esistono da tempo varie regolamentazioni locali che, intervenendo sia sulle condizioni ambientali che sulle apparecchiature, hanno tentato di limitare i pericoli di innesco dell'esplosione.

La necessità di identificare norme comunitarie uniformi, ha portato alla definizione ed alla emanazione delle Direttive europee 94/9/EC e 1999/92/EC, più conosciute con l'acronimo ATEX (**AT**mosfera **EX**plosiva).

In particolare:

1. direttiva europea 94/9/EC (ATEX 100A) si occupa dei sistemi di prevenzione da mettere in atto sulle apparecchiature e quindi, nel nostro caso specifico, è la direttiva di riferimento per i riduttori.
2. Direttiva europea 1999/92/EC (ATEX 137) si occupa della sicurezza del personale durante l'installazione, il funzionamento o la manutenzione di sistemi potenzialmente esplosivi.

È importante descrivere il sistema di identificazione degli apparecchi, definito dalla norma ATEX100A, ricordando che i tipi di atmosfera potenzialmente esplosiva sono due:

- la miscela esplosiva gas-aria, che viene identificata con la lettera **G**;
- la miscela esplosiva polvere-aria, che viene identificata con la lettera **D**.

Gruppi

I gruppi a cui possono appartenere i riduttori, sono due e vengono rappresentati in numeri romani. I gruppi definiscono una prima classificazione di massima delle possibili condizioni operative in relazione al tipo ed alla pericolosità dell'ambiente.

- **Gruppo I** : si riferisce all'interno delle miniere dove il rischio di esplosione è elevatissimo.
- **Gruppo II**: si riferisce a tutte le altre condizioni di atmosfera potenzialmente esplosiva.

Categorie

All'interno dei gruppi, le categorie definiscono il livello di protezione degli apparecchi in funzione delle condizioni operative.

All'interno del gruppo I si evidenziano due categorie:

- M1 livello di protezione molto alto
- M2 livello di protezione alto

All'interno del gruppo II si evidenziano tre categorie:

- 1 livello di protezione molto alto
- 2 livello di protezione alto
- 3 livello di protezione normale

1. INTRODUCTION

1.1. LE DIRETTIVE ATEX

Some manufacturing processes occur in the presence of gas or dust that under certain conditions can explode or spontaneously combust, causing serious injury and damage.

Since it is impossible, under most circumstances, to isolate manufacturing equipment from such potentially explosive atmospheres, years ago national standards were introduced to regulate the manufacturing environment and the manufacturing equipment itself in an attempt to limit any risk of explosion.

*The need to establish uniform standards throughout the European Union has now led to the definition and publication of European Directives 94/9/EC and 1999/92/EC, more commonly referred to as the ATEX (**AT**mosphère **EX**plosive) Directives. In particular:*

1. *European Directive 94/9/EC (ATEX 100a) defines the anti-explosion systems that must be implemented on manufacturing equipment. This is the directive we refer to in the design and manufacture of our gearboxes.*
2. *European Directive 1999/92/EC (ATEX 137) governs the safety of personnel at risk from potentially explosive atmospheres during system installation, operation and maintenance.*

To fully understand the manufacturing equipment identification system used in the ATEX 100a directive we must always remember that there are two types of potentially explosive atmosphere:

- *explosive Gas-air mixes, identified by the letter **G**;*
- *explosive Dust-air mixes identified by the letter **D**.*

Groups

Gearboxes belong to one of two groups, identified by the Roman numerals I and II. These groups are an initial, rough classification of possible operating conditions on the basis of the type of environment and the level of risk.

- **Group I** covers equipment used in mines where there is an extremely high risk of explosion.
- **Group II** covers all other potentially explosive atmospheric conditions.

Categories

Within these groups, different categories define the level of protection that equipment provides in various operating conditions.

Group I contains two categories:

- *M1 very high level of protection*
- *M2 high level of protection*

Group II contains three categories:

- *1 very high level of protection*
- *2 high level of protection*
- *3 normal level of protection*





Zone

Le zone definiscono la probabilità che ha l'apparecchio di trovarsi in presenza di una atmosfera potenzialmente esplosiva. Le zone sono tre (anche se raddoppiano, come definizione, in funzione del tipo di atmosfera):

- zona **0** o **20**: funzionamento in presenza costante di atmosfera potenzialmente esplosiva tipo G o D.
- Zona **1** o **21**: funzionamento in presenza occasionale (ma legata alle condizioni operative normali) di atmosfera potenzialmente esplosiva tipo G o D.
- Zona **2** o **22**: funzionamento in presenza occasionale e rara (non legata alle condizioni operative normali) di atmosfera potenzialmente esplosiva tipo G o D.

Temperatura

La massima temperatura ammissibile dichiarata dal costruttore dell'apparecchio, è l'ultimo dato fondamentale.

Per l'ambiente Gas occorre dichiarare un livello di temperatura scelto tra quelli indicati dalla norma e indicato dalla lettera T seguita da un opportuno numero. Esempio: T4 = 135 °C. In questo caso l'apparecchio non dovrà mai superare l'80% di 135 °C , ovvero 108 °C.

Per l'ambiente polveri occorre dichiarare direttamente la temperatura in °C.

La classificazione completa può essere riassunta nella seguente tabella.

Zones

Zones refer to the probability that an item of equipment will be located in a potentially explosive atmosphere. Three zones have been defined:

- Zone **0** or **20**: permanent operation in a potentially explosive atmosphere of type G or D.
- Zone **1** or **21**: occasional operation (under normal operating conditions) in a potentially explosive atmosphere of type G or D.
- Zone **2** or **22**: infrequent operation (under abnormal operating conditions) in a potentially explosive atmosphere of type G or D.

Temperature

The last fundamental datum for manufacturing equipment is the maximum permitted operating temperature declared by the equipment manufacturer.

Equipment for use in Gas atmospheres must have a declared maximum operating temperature chosen from these specified in the directive and identified by the letter T followed by a number. E.g. T4 = 135 °C. This means that the equipment in question must never exceed 80% of 135 °C , or 108 °C. Equipment for use in Dust atmospheres must have a maximum operating temperature declared directly in °C .

The complete classification system is summarised in the table below.

	Gruppo I - Miniera Group I - Mines		Gruppo II - Altre zone con atmosfera potenzialmente esplosiva Group II - Other locations with potentially explosive atmospheres					
Categoria Category	M1	M2	1		2		3	
Tipo di atmosfera Type of atmosphere			G	D	G	D	G	D
Zona Zone			0	20	1	21	2	22
Protezione riduttore Gearbox protection rating					c, k	c, k	c, k	c, k





1.2. LINKS UTILI

- Guida alla implementazione delle direttive fondate sul Nuovo Approccio e Approccio Globale (pdf inglese)
http://europa.eu.int/comm/enterprise/newapproach/legislation/guide/document/1999_1282_en.pdf
- Introduzione ATEX n.1 (html inglese)
<http://europa.eu.int/comm/enterprise/atex/>
- Introduzione ATEX n.2 (html inglese)
<http://europa.eu.int/comm/enterprise/atex/infor.htm>
- Direttiva 95/4/CE concernente il ravvicinamento delle legislazioni degli Stati membri relative agli apparecchi e sistemi di protezione destinati ad essere utilizzati in atmosfera potenzialmente esplosiva (pdf italiano)
<http://europa.eu.int/comm/enterprise/atex/direct/text94-9-it.pdf>
- Corrigendum alla 95/4/CE (pdf italiano)
<http://europa.eu.int/comm/enterprise/atex/direct/corrig-it.pdf>
- Riferimenti legislativi nazionali della Trasposizione della 95/4/CE (html inglese)
<http://europa.eu.int/comm/enterprise/atex/direct/trans94-9.htm>
- Linee guida alla applicazione della 95/4/CE (pdf italiano)
http://europa.eu.int/comm/enterprise/atex/guide/guide_it.pdf
- Considerazioni del Comitato su temi di rilievo (html inglese)
<http://europa.eu.int/comm/enterprise/atex/standcomm.htm>
- Chiarimenti/Interpretazioni del Comitato anni 1999,2000,2001,2002 (html inglese)
<http://europa.eu.int/comm/enterprise/atex/nb/sheets.htm>
- Decisioni del ExNBG (Gruppo Organismi Notificati) approvate dal Comitato (html inglese)
<http://europa.eu.int/comm/enterprise/atex/nb/hotl.htm>
- Elenco Riferimenti Normativi Cen e Cenelec (html inglese)
<http://europa.eu.int/comm/enterprise/newapproach/standardization/harmstds/reflist/atex.html>
- Le normative di Nuovo Approccio nel Mercato Comune (html inglese)
<http://www.newapproach.org/>
- Elenco Organismi Notificati (pdf italiano)
<http://europa.eu.int/comm/enterprise/newapproach/legislation/nb/en94-9-ec.pdf>
- Direttiva 1999/92/CE relativa alle prescrizioni minime per il miglioramento della tutela della sicurezza e della salute dei lavoratori che possono essere esposti al rischio di atmosfere esplosive (pdf italiano)
<http://europa.eu.int/comm/enterprise/atex/dir92-it.pdf>

1.2. USEFUL LINKS

- Guide to the implementation of directives based on the New Approach and the Global Approach (pdf format in English)
http://europa.eu.int/comm/enterprise/newapproach/legislation/guide/document/1999_1282_en.pdf
- Introduction to ATEX No.1 (html format in English)
<http://europa.eu.int/comm/enterprise/atex/>
- Introduction to ATEX No.2 (html format in English)
<http://europa.eu.int/comm/enterprise/atex/infor.htm>
- Directive 95/4/CE concerning the transposition of member state legislation on protective equipment and systems for use in potentially explosive atmospheres (pdf format in Italian)
<http://europa.eu.int/comm/enterprise/atex/direct/text94-9-it.pdf>
- Errata corrige for 95/4/CE (pdf format in Italian)
<http://europa.eu.int/comm/enterprise/atex/direct/corrig-it.pdf>
- Transposition of directive 95/4/CE into national law (html format in English)
<http://europa.eu.int/comm/enterprise/atex/direct/trans94-9.htm>
- Guidelines for the application of 95/4/CE (pdf format in Italian)
http://europa.eu.int/comm/enterprise/atex/guide/guide_it.pdf
- Considerations by the ATEX Standing Committee (html format in English) <http://europa.eu.int/comm/enterprise/atex/standcomm.htm>
- Clarification/Interpretation Sheets noted by the Atex Standing Committee, years 1999,2000,2001,2002 (html format in English)
<http://europa.eu.int/comm/enterprise/atex/nb/sheets.htm>
- ExNBG HOTL Decisions noted by the Atex Standing Committee (html format in English)
<http://europa.eu.int/comm/enterprise/atex/nb/hotl.htm>
- Cen and Cenelec Standards reference list (html format in English)
<http://europa.eu.int/comm/enterprise/newapproach/standardization/harmstds/reflist/atex.html>
- New Approach Standardisation in the Internal Market (html format in English)
<http://www.newapproach.org/>
- List of Notified Bodies (pdf format in Italian)
<http://europa.eu.int/comm/enterprise/newapproach/legislation/nb/en94-9-ec.pdf>
- Directive 1999/92/CE concerning the minimum requirements for improving health and safety for workers exposed to potentially explosive atmospheres (pdf format in Italian)
<http://europa.eu.int/comm/enterprise/atex/dir92-it.pdf>





2. DESCRIZIONE RIDUTTORI

2. DESCRIPTION OF GEARBOXES

DESIGNAZIONE / DESIGNATION

BPH

Tipo
Type

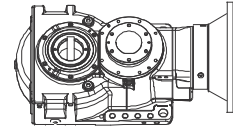
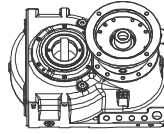

PH

Riduttore ad assi paralleli
Planetary helical

BPH

Riduttore ad assi ortogonali
Bevel planetary helical gearboxes

3

Stadi di riduzione
Reduction stages

	i_{min}	i_{max}
2	12	40
3	40	250
4	150	2000
5	600	10000

	i_{min}	i_{max}
3	30	150
4	100	1200
5	500	10000

23

Taglia
Size

	13	16	18	20	23	25	28
T_2 [Nm]	3900	5800	7700	10900	16700	24200	35000
\varnothing_{H7} [mm]	70	70	80	90	100	120	140

K

Albero cavo
Hollow shaft

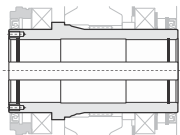

K

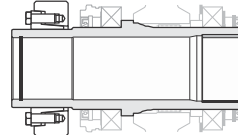

D

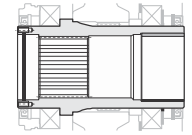

S

83.42

Rapporti di trasmissione esatti
Exact ratio

Vedere tabelle dati tecnici (i_{eff})
See data sheet (i_{eff})



IEC 180

Ingresso
Input



IEC.



M

B3

Posizione di montaggio
Mounting position

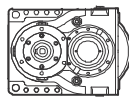

PH

B3

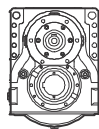

B6

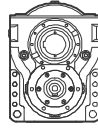

B7

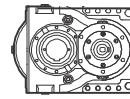

B8

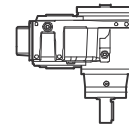

V5

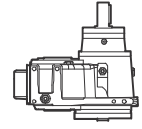

V6

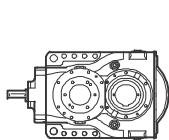

BPH

B3

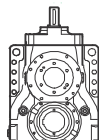

B6

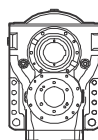

B7

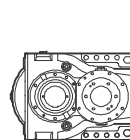

B8

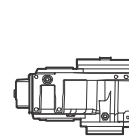

V5

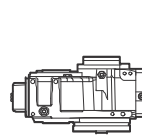

V6

BPH323K / 83.42 / IEC180 / B3

Esempio di designazione
Designation example

Riduttore ortogonale a 3 stadi, taglia 23, albero cavo con sede linguetta, rapporto $i=83.42$, predisposizione motore elettrico IEC 180, montaggio B3

3 Stages Bevel Planetary Helical gearbox, size 23, hollow shaft with keyhole ratio $i=83.42$, adaptor for electric motor IEC 180, B3 mount





Riduttori ad assi ortogonali taglia 13 / Bevel planetary helical gearboxes size 13

Posizioni di montaggio taglia 13 / Mounting position size 13

BPH13K	B31 	B81 	B61 	B62 	B72 	B71 	V51 	V52
	B32 	B82 						
BPH13KD/S + FL13	B3 	B8 	B6 		B7 		V51 	V52
BPH13D/S	B31 	B81 	B61 	B62 	B72 	B71 	V511 	V521
	B32 	B82 					V512 	V522
BPW13K	B3 	B81 	B61 	B62 	B72 	B71 	V51 	V52
		B82 						
BPW13K/D/S + FL13	B3 	B8 	B6 		B7 		V51 	V52
BPW13D/S	B31 	B81 	B61 	B62 	B72 	B71 	V511 	V521
	B32 	B82 					V512 	V522



Posizioni di montaggio riduttori / Gearbox mounting position

Serie BPH/BPH series

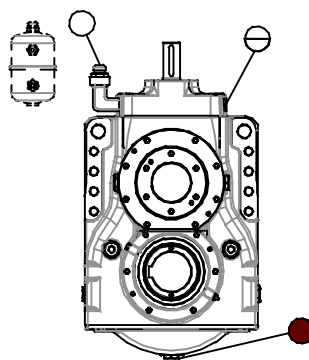
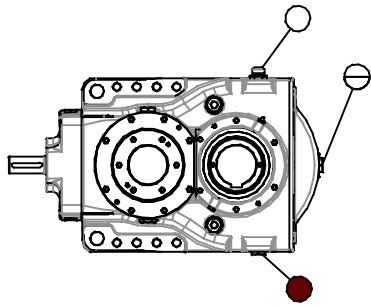

B6

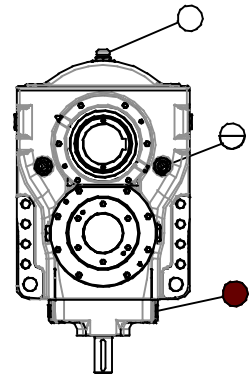

B7

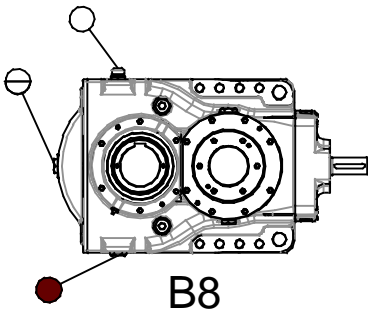

B8

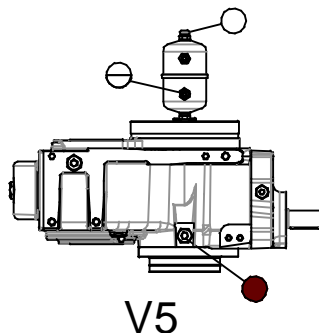

V5

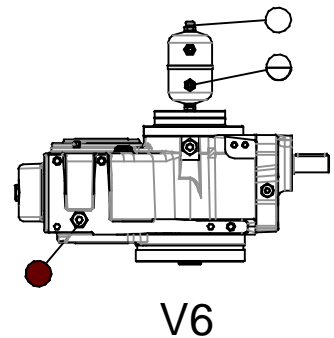

V6

Serie PH/PH series

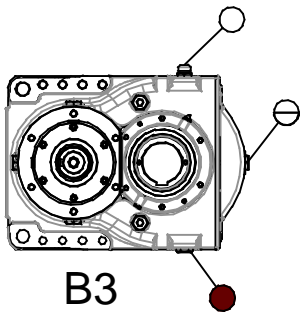

B3

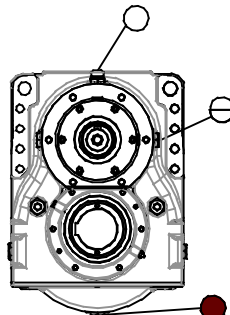

B6

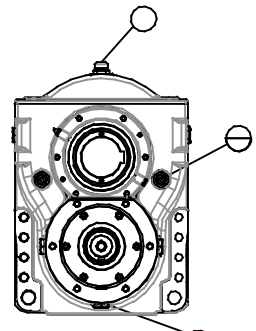

B7

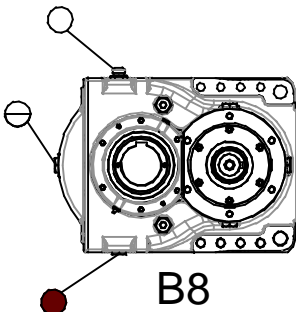

B8

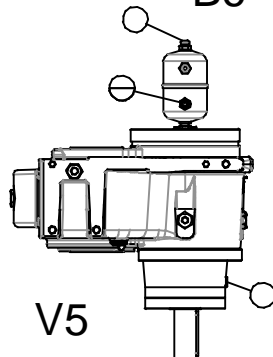

V5

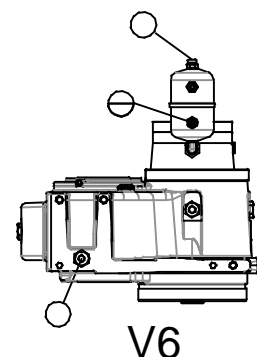

V6

● Tappo magnetico e scarico olio
Magnetic drain plug

⊖ Tappo livello olio
Oil level plug

○ Tappo carico e sfiato olio
Breather plug



www.pivposiplan.com



2.1. USO PREVISTO

- 1) I riduttori nel seguente catalogo appartengono esclusivamente al Gruppo II, zone 1 e 2 (caselle grigie della tabella a pag. 4).
- 2) La temperatura di funzionamento deve appartenere alle seguenti classi:
 - T4 nell'ambiente GAS. Ovvero, la temperatura superficiale esterna nel punto più caldo non deve superare 108 °C corrispondenti all' 80% di 135 °C.
 - 108 °C nell'ambiente POLVERI.
- 3) Per le posizioni B6/V5/V6 la potenza termica deve essere ridotta secondo indicazioni riportate nella tabella delle prestazioni.
- 4) La lubrificazione viene effettuata solo per sbattimento. Non sono ammessi dispositivi ausiliari separati. Il livello dell'olio è quello previsto nelle varie "posizioni di montaggio" (rif. pag. 7-8)
- 5) Non sono ammessi accessori diversi da quelli previsti.
- 6) La velocità di ingresso al riduttore non deve essere superiore a 3000 giri/min.
- 7) I riduttori debbono funzionare con temperature ambiente comprese tra -20 °C ÷ + 40°C. **Non è ammesso il funzionamento al di sopra della temperatura massima ambiente di 40 °C a meno di non operare a potenze inferiori alla potenza termica ammessa e dopo un opportuno test di funzionamento.**
- 8) Le prescrizioni relative all'installazione e manutenzione del riduttore sono contenute nel "**Manuale di installazione e manutenzione riduttori gamma Atex, codice MT-7015-061**". Il documento deve essere messo a disposizione del personale addetto e deve essere conservato accuratamente nei pressi dell'impianto.

2.2. DATI DI SELEZIONE DEL RIDUTTORE

Per definire i parametri fondamentali necessari per una selezione ottimale del riduttore ci si può servire di una check list come la seguente, compilata per dimostrazione, in accordo all'esempio di selezione riduttore del Cap. 3.2.

2.1. PROPER USE

- 1) *The gearboxes in this catalogue belong exclusively to Group II, zones 1 and 2 (cells shaded in grey in the table on page 4).*
- 2) *Operating temperature must be in the following classes*
 - *T4 in GAS atmospheres. This means that the external surface temperature at the hottest point must not exceed 108 °C, being 80% of 135 °C.*
 - *108 °C in DUST atmospheres.*
- 3) *For mounting position B6/V5/V6 the thermal power must be lowered according to information in the performance table*
- 4) *Only splash lubrication must be used. No separate auxiliary lubrication systems must be used. For oil level look at the table "mounting position" (ref. pag.7-8)*
- 5) *No accessories other than those listed by the manufacturer must be used.*
- 6) *The input speed to the gearbox must not exceed 3000 rpm*
- 7) *The gearboxes must operate in ambient temperatures between -20 °C and + 40°C. **Operation in ambient temperatures in excess of 40 °C is forbidden unless units operate at thermal power levels below maximum permitted thermal power, and even then only after adequate functioning tests.***
- 8) *Gearbox installation and maintenance requirements are contained in the "**Atex Gearbox Installation and Maintenance Manual,code MT-7015-0610**". This manual must be made available to all relevant personnel and must be kept near the equipment.*

2.2. DATA NEEDED TO SELECT A GEARBOX

It is advisable to use a check-list as shown below to record the values needed to select the correct gear unit. The list shown here has been compiled as an example to illustrate the gearbox selection described in Section 3.2.

Tipo di atmosfera potenzialmente esplosiva / Type of potentially explosive atmosphere			G		D		
Zona di lavoro del riduttore / Gearbox operating zone			Categoria Category	2	X	1	21
			Categoria Category	3		2	22
Classe di temperatura massima della superficie del riduttore consentita in presenza di gas Maximum permitted surface temperature class of gearbox in gas atmospheres			T4				
Temperatura massima della superficie del riduttore consentita in presenza di polveri Maximum permitted surface temperature class of gearbox in dust atmospheres							108°C
$n_{1\max}$	[rpm]	Velocità massima in ingresso / Maximum input speed	1500				
i		Rapporto totale / Overall gear ratio	50				
P_{\max}	[kW]	Potenza installata / Installed power	10				
P	[kW]	Potenza necessaria / Required power	9.42				
K ..%cdf		Fattore di applicazione (in alternativa ciclo di impiego) Application factor (or duty cycle)	1.25				
Z		Numero di avviamenti per ora / Number of starts per hour	1				
T_{amb}	[°C]	Temperatura ambiente (contattare il servizio tecnico-commerciale PIVOSIPLAN per temperature < -20°C e > 40°C) Ambient temperature (contact PIVOSIPLAN's Technical Service for temperatures < -20°C or > +40°C)	30				





2.3. TARGHETTA DI IDENTIFICAZIONE



Ogni riduttore è dotato di **Targhetta di Identificazione** e di una **Dichiarazione di Conformità** (secondo Allegato VIII) ai sensi della direttiva 94/9/CE.

La Targhetta di Identificazione contiene le principali informazioni tecniche relative alle caratteristiche funzionali e costruttive del riduttore; deve perciò essere mantenuta integra e visibile.

2.3. IDENTIFICATION PLATE

Every gearbox is fitted with an **identification plate** and comes complete with a **Declaration of Conformity** (according to Appendix VIII) in conformity to Directive 94/9/CE. The identification plate provides essential technical data on the gearbox' functional and structural characteristics and must be kept undamaged and clearly visible.

ESEMPIO / EXEMPLE :

 PIVOSIPLAN srlu info@pivposiplan.com Tel. +39(0)425 594162 Fax. +39(0)425 585821 Via Dalla Francesca127 35040 Piacenza d'Adige (PD) - ITALY -				S/N	(1)
				MADE	(2)
				GEARBOX ITEM	
				(3)	
INPUT ITEM					
(4)					
i =	(5)	MOUNT =	(6)	 II 2GD c k T4 T108°C	
DEP.NO.		(7)			
DESIGNATION		(8)			

Riduttore appartenente al gruppo II Categoria 2 Gas o Dust (polvere) e tipo di protezione contro l'accensione

Gearbox belongs to Group II, Class 2, Gas or Dust atmospheres and protection type

Livello di temperatura massima di funzionamento in atmosfera Gas
Maximum permitted temperature class for operation in Gas atmospheres

Livello di temperatura massima di funzionamento in atmosfera Dust (polvere)
Maximum permitted temperature for operation in Dust atmospheres

Indicazioni	Rif. Ref.	Data
Numero di serie	1	Serial number
Data di produzione	2	Manufacturing date
Codice riduttore	3	Gearbox item
Tipo di entrata	4	Input type
Rapporto totale	5	Total ratio
Posizione di montaggio	6	Mounting position
Numero/Ente di deposito	7	Number of deposit / Notified body
Designazione riduttore	8	Gearbox description



3. DESCRIZIONI TECNICHE

Rapporto di riduzione i_{eff}

Rappresenta la relazione fra la velocità in ingresso n_1 ed uscita del riduttore n_2 . La modularità della gamma proposta da Pivposiplan permette la disponibilità di altri rapporti oltre a quelli indicati: consultare Pivposiplan per la eventuale disponibilità di ulteriori rapporti.

Coppia nominale T_2 [Nm]

Valore della coppia in uscita riduttore riferita ad una durata di 10000 ore di funzionamento, con affidabilità dei cuscinetti superiore al 98%, calcolata secondo ISO 281. Tale valore (fattore di applicazione uguale ad 1) è indicato in relazione alle diverse velocità in ingresso. Gli ingranaggi sono calcolati a durata infinita.

Coppia massima T_{2max} [Nm]

Coppia massima d'uscita ammissibile, come picco o per brevi durate. Per azionamenti che comportano un elevato numero di avviamenti o inversioni, anche la coppia massima di impiego deve essere opportunamente limitata in relazione alla resistenza degli ingranaggi o degli alberi.

Coppia limite T_N [Nm]

È la coppia convenzionale che caratterizza la grandezza del riduttore. Trova corrispondenza nella coppia limite secondo I.S.O.(D.P. 6336).

Potenza in uscita P_2 [kW]

Combinazione del valore di coppia T_2 alla relativa velocità in uscita riduttore.

Potenza termica P_T [kW]

Le potenze termiche sono indicate nelle tabelle che riassumono le prestazioni tecniche dei vari riduttori. I valori pubblicati fanno riferimento ad un impiego continuo nelle seguenti condizioni:

- lubrificazione a sbattimento;
- ad una velocità di ingresso riduttore non superiore a 3000 giri/min;
- per una temperatura massima della superficie esterna di 108 °C nel punto più caldo;
- nelle condizioni di impiego "ambiente largo".

Velocità in ingresso n_1 [rpm]

I valori di velocità in ingresso indicati nel catalogo sono due per coprire la maggior parte delle applicazioni del settore industriale.

Valori intermedi si possono ottenere per semplice interpolazione.

Velocità in uscita n_2 [rpm]

Rappresenta il valore della velocità dell'albero in uscita ottenuta dividendo la velocità dell'albero in ingresso per il rapporto i_{eff} .

3. TECHNICAL DEFINITIONS

Gear ratio i_{eff}

This is the effective ratio between gearbox input speed n_1 and output speed n_2 . The modular composition of Pivposiplan's gearbox range permits customers to specify ratios other than those shown. Contact Pivposiplan's Technical Service for information on other ratios.

Nominal torque T_2 [Nm]

This is the output torque that the gearbox is capable of producing for a working life of 10,000 hours of operation with a bearing reliability factor of over 98% calculated according to ISO 281. Output torque (for an application factor = 1) is declared for various input speeds. Gears are assumed to have an infinite working life.

Maximum torque T_{2max} [Nm]

This is the maximum permitted output torque for peaks or short periods. In drives that perform a large number of starts or direction reversals, maximum torque must be suitable reduced to take account of gear and shaft resistance.

Limit torque T_N [Nm]

This is the conventional torque value that defines the size of the gearbox. Limit torque corresponds to maximum torque as established by I.S.O. (D.P. 6336).

Output power P [kW]

This is the value for output torque T at the gearbox' output speed.

Thermal power P_T [kW]

Thermal power ratings are shown in the gearbox data tables. The declared values refer to continuous duty under the following conditions:

- splash lubrication used;
- input speeds no higher than 3000 rpm;
- maximum external surface temperature of 108 °C at the hottest point;
- open environment operating conditions".

Input speed n_1 [rpm]

Gearboxes are available with two input speeds to cover most industrial applications.

Intermediate value can be obtained by interpolation

Output speed n_2 [rpm]

This is the speed of the gearbox' output shaft and is obtained by dividing the speed of the input shaft by the gear ratio i_{eff} .





3.1. SELEZIONE RIDUTTORE

Per eseguire una corretta selezione del riduttore, occorre confrontare le seguenti grandezze:

- 1) potenza applicata al riduttore (fornita dal motore primo);
- 2) potenza meccanica assorbita dall'applicazione (da calcolare. Vedere anche l'esempio seguente);
- 3) potenza meccanica ammissibile (valore P_2 a catalogo);
- 4) potenza termica massima (valore P_T a catalogo).

La potenza meccanica richiesta dall'applicazione si ottiene moltiplicando la coppia nominale richiesta per il corrispondente fattore di applicazione K_A e Cs.

Con questo valore si può operare la scelta del riduttore verificando che le potenze massime ammesse P_2 e P_T siano entrambe SUPERIORI alla potenza applicata (motore).

Fattore di applicazione K_A

Il fattore di applicazione viene definito dal tipo di motore primo e dal tipo di macchina azionata dal riduttore. Si tratta di un valore empirico stabilito dalle norme attraverso l'esperienza storica delle diverse applicazioni e tiene conto delle variazioni di carico, degli urti della trasmissione e della incertezza relative alla variazione dei parametri che concorrono alla trasmissione della potenza.

L'importanza della macchina azionata è fondamentale nella individuazione del fattore K_A in quanto i motori utilizzati in combinazione con i riduttori sono normalmente elettrici oppure idraulici e quindi classificati come motorizzazioni ad azionamento uniforme.

Deve essere moltiplicato per la coppia (o la potenza) nominale di funzionamento per ottenere la coppia (o la potenza) di riferimento da confrontare con il valore del catalogo.

Il fattore K_A è indicativo, per verifiche più precise consultare il servizio tecnico Pivposiplan.

La tabella seguente riporta alcuni valori del fattore di applicazione.

3.1. SELECTING THE RIGHT GEARBOX

The following values must be taken into consideration in order to choose the right gearbox for your needs:

- 1) power applied to the gearbox (by the drive motor);
- 2) mechanical power absorbed by the application (to be calculated as shown in the example below);
- 3) maximum permitted mechanical output power (P_2 in the catalogue);
- 4) maximum thermal power (P_T in the catalogue).

The mechanical power required by the application is obtained by multiplying the required nominal torque by the corresponding application factor K_A or Cs.

Once the required mechanical power value is known, the correct gearbox can then be selected. Make sure, however, that the maximum permitted powers P_2 and P_T of the selected gearbox are both GREATER THAN the applied power (from the drive motor).

Application factor K_A

The application factor is determined by the type of drive motor and the type of machine driven by the gearbox. The application factor is an empirical and normative value established on the basis of experience in different applications. It takes into account variations in load, transmission shock and the probability of variation in power transmission parameters. The driven machine plays the biggest part in determining a K_A factor since gearbox drive motors are normally either electric or hydraulic and therefore classed as uniform drive motors. Multiply the application factor K_A by the nominal operating torque (or power) to obtain the reference torque (or power) value to look up in the catalogue.

K_A factor is approximate, Contact Pivposiplan Technical Service for detailed information.

The following table shows a selection of common application factors.



FATTORE DI SERVIZIO K_A

Agitatori / Mescolatori

Liquidi a densità costante
Liquidi a densità variabile o con solidi in sospensione
Turbodissolutori

Alimentatori / Dosatori

Rotanti per polveri o granulati
Rotanti per materiali non uniformi
A nastro, a coclea, a piastre
Alternativi o a scosse

Elevatori / Trasportatori

A nastro, con scaricamento centrifugo o a gravità
A tazze

A tapparella
Ascensori, montacarichi, ponteggi, impianti di risalita

frantoi / Trituratori / Granulatori

Gomma, plastica, riciclaggio
Minerali, pietre, cemento

Industria mineraria ed estrattiva

Trasportatori, argani, sfangatrici, ruote scolatrici
Frese, disgregatori, estrartrici a tazze
Movimento carri su rotaia
Mulini a barre e a sfere
Mulini a martelli
Vagli di lavaggio e selezione rotanti

Gru / Argani / Sollevamenti

Traslazioni gru, carrelli
Sollevamenti
Rotazione bracci

Industria alimentare

Triturazione e lavorazione carni
Laminatoi, estrusori, impastatrici
Lavabottiglie
Mulini, frantoi e trinciatrici per canna da zucchero
Taglio, lavaggio e cottura barbabietole

Industria del legno

Caricatori, impilatori, trasportatori per tavole e trucioli
Trasportatore tronchi
Macchine utensili in genere
Scortecciatrici meccaniche
Scortecciatrici a tamburo

Industria tessile

Cardatrici, filatoi, lavatrici, telai

Industria lavorazione argilla

Impastatrici, sfangatrici e filtri
Trafile ed estrusori
Presse e compattatori

Lavorazione gomma e plastica

Estrusori per plastica
Estrusori per gomma
Mescolatori, trafile, calandre, laminatoi
Frantumatrici

GEAR UNIT APPLICATION FACTORS K_A

Agitators / Mixers

Pure liquids
Liquids-variable density or liquids and solids
Heavy duty blunger

Feeders / Batchers

Rotary for dust or prill
Rotary for not uniform materials
Belt, screw, plate
Reciprocating, vibrator

Elevators / Conveyors

Belt,centrifugal or gravity discharge
Bucket
Escalators
Man lift, hoisting towers, mobile scaffolding, passenger transport

Crushers / Granulators

Rubber, plastics, recycling
Minerals, stone,cement

Mining industry

Conveyors,winches,desilting and dewatering machine
Cutters, excavators
Vehicles on rails
Rotary mills (rod,roller,ball)
Hammer mills
Rotary screening

Cranes / Winches / Travelling lift

Travel cranes
Hoist
Slewing

Food industry

Mixers and meat grinders
Mill roll train, extruder,dough mixers
Bottle washing machine
Sugar cane knives
Beet slicer,washer and cookers

Lumber and woodworking industries

Loaders, pallet stackers, boards and chip conveyors
Logs conveyors
Tools machines
Mechanical barkers
Drum barkers

Textile industry

Cards,spinners,washers,frames

Clay working machinery

Pug mills, rotary deslimers and filters
Drive rollers and extruders
Brick and tile presses

Rubber and plastics industries

Plastics extruders
Rubber extruders
Mixing mills, tubers, calenders, rolling mills
Crackers

K_A

Pure liquids	1.00
Liquids-variable density or liquids and solids	1.25
Heavy duty blunger	1.50
Rotary for dust or prill	1.00
Rotary for not uniform materials	1.25
Belt, screw, plate	1.00
Reciprocating, vibrator	1.75
Belt,centrifugal or gravity discharge	1.25
Bucket	1.25~1.50
Escalators	1.25~1.50
Man lift, hoisting towers, mobile scaffolding, passenger transport	*
Rubber, plastics, recycling	1.25
Minerals, stone,cement	1.75
Conveyors,winches,desilting and dewatering machine	1.25
Cutters, excavators	1.50
Vehicles on rails	1.25
Rotary mills (rod,roller,ball)	1.50
Hammer mills	1.75
Rotary screening	1.25
Travel cranes	1.50
Hoist	*
Slewing	1.50
Mixers and meat grinders	1.00
Mill roll train, extruder,dough mixers	1.25
Bottle washing machine	1.00
Sugar cane knives	1.50
Beet slicer,washer and cookers	1.25
Loaders, pallet stackers, boards and chip conveyors	1.00
Logs conveyors	1.50
Tools machines	1.25
Mechanical barkers	1.50
Drum barkers	1.75
Cards,spinners,washers,frames	1.00
Pug mills, rotary deslimers and filters	1.25
Drive rollers and extruders	1.50
Brick and tile presses	1.75
Plastics extruders	1.25
Rubber extruders	1.50
Mixing mills, tubers, calenders, rolling mills	1.25
Crackers	1.75





FATTORE DI SERVIZIO K_A

Macchinari per magazzini ed imballaggi

Pallettizzatori, accatastatori, traslatori

Trattamento acque

Biodischi

Coclee, raschiafanghi, griglie rotanti

Aereatori e rototrituratori

Siderurgia e metallurgia

Cesoie, troncatrici, raddrizzatrici

Traini, trafilati, profilatrici, piegatrici, spianatrici

Vie a rulli

Macchine e impianti per colata continua

Ribaltatori e traslatori

Traslazione siviere

Lavorazione carta

Agitatori, mescolatori, estrusori, essiccatore

Avvolgitori e svolgitori

Sminuzzatori, calandre, lucidatrici, presse

Forni rotanti

Essicatori, raffreddatori, forni rotativi, lavatrici

Buratti e forni per cementeria

Per casi non previsti in tabella consigliamo di utilizzare i valori sotto riportati.

Applicazione con funzionamento uniforme

Sovraccarichi moderati

Sovraccarichi moderati Sovraccarichi forti

Sovraccarichi molto forti

GEAR UNIT APPLICATION FACTORS K_A

Wrapping and stacking machinery

Palletizing and stacking machinery

Sewage disposal equipment

Biological tanks (revolving disk)

Dewatering screws, collectors, rotary screens

Aerators, rotary breakers

Metallurgy and metal mills

Shears, croppers, straightening presses

Drive rollers, bending and flattening roll

Roller ways

Continuous casting machinery

Reversing and pushers

Ladle pushers

Paper mills

Agitators, mixers, chip feeders, coating rolls

Winders and suction rolls

Chippers, calenders, glazing machines, presses

Rotating drums

Dryers, chillers, rotary kilns, washing machines

Tumblers, cement kilns

For application different from those indicated, we suggest to use the following factors

Uniform load

Moderate overloads

Heavy overloads

Very heavy overloads or frequent inversion

K_A

1.25

1.00

1.25

1.50

1.50

1.25

1.25

1.25

1.75

1.50

1.25

1.25

1.75

1.00

1.75

1.00

1.25-1.50

1.50-1.75

1.75-2.00

* Riferirsi alla norma specifica / * See standard specification





Planetary helical gearboxes

PH.13

EX	n ₁ = 3000 min ⁻¹			n ₁ = 1500 min ⁻¹			n ₁ = 1000 min ⁻¹			10000 HOURS LIFE		
	i _{eff}	n ₂ [min ⁻¹]	P _{N1} [kW]	T _{N2} [Nm]	n ₂ [min ⁻¹]	P _{N1} [kW]	T _{N2} [Nm]	n ₂ [min ⁻¹]	P _{N1} [kW]	T _{N2} [Nm]	T _{2ISO} [Nm]	P _T [kW]
PH213	13.9	216	26.9	1167	108	16.5	1436	72	12.5	1622	3850	22 (*)
	15.8	190	26.2	1293	95	16.1	1592	63	12.1	1798	3900	
	16.4	183	26.9	1377	91	16.5	1695	61	12.5	1915	3530	
	18.7	161	26.2	1527	80	16.1	1880	54	12.1	2123	3530	
	19.8	152	24.8	1528	76	15.3	1882	51	11.5	2125	3130	
	21.3	141	23.5	1562	70	14.5	1923	47	10.9	2172	3530	
	23.0	131	22.1	1584	65	13.6	1950	44	10.2	2202	3530	
	25.6	117	20.7	1652	59	12.7	2034	39	9.6	2297	3130	
	27.6	109	19.6	1690	54	12.1	2080	36	9.1	2349	3130	
	30.9	97	17.5	1683	49	10.8	2071	32	8.1	2339	3010	
	33.2	90	17.2	1785	45	10.6	2198	30	8.0	2482	3130	
	35.2	85	15.8	1741	43	9.4	2057	28	6.2	2057	2570	
	37.2	81	15.9	1847	40	9.8	2274	27	7.4	2568	3130	
	42.4	71	14.5	1921	35	8.9	2366	24	6.2	2477	3100	
PH313	50.8	59.1	13.16	2064	29.5	8.10	2542	19.7	6.10	2870	3900	15
	57.7	51.9	12.03	2146	26.0	7.40	2641	17.3	5.57	2983	3900	
	60.0	50.0	11.79	2183	25.0	7.26	2688	16.7	5.46	3036	3530	
	65.7	45.7	11.25	2283	22.8	6.93	2810	15.2	5.22	3174	3900	
	71.0	42.3	10.41	2282	21.1	6.41	2810	14.1	4.83	3173	3900	
	74.8	40.1	10.27	2374	20.0	6.32	2923	13.4	4.76	3301	3900	
	80.7	37.2	9.74	2428	18.6	6.00	2989	12.4	4.52	3376	3900	
	83.8	35.8	9.33	2414	17.9	5.74	2972	11.9	4.05	3143	3530	
	85.3	35.2	9.15	2412	17.6	5.63	2969	11.7	4.24	3353	3900	
	88.3	34.0	8.99	2453	17.0	5.53	3020	11.3	3.85	3153	3530	
	92.0	32.6	8.89	2525	16.3	5.47	3109	10.9	4.12	3511	3900	
	95.5	31.4	8.46	2495	15.7	5.21	3071	10.5	3.92	3469	3900	
	97.0	30.9	8.57	2566	15.5	5.27	3159	10.3	3.94	3540	3900	
	100.7	29.8	8.20	2551	14.9	4.98	3099	9.9	3.41	3179	3530	
	108.5	27.6	7.92	2654	13.8	4.87	3267	9.2	3.54	3565	3900	
	110.5	27.1	7.82	2669	13.6	4.81	3285	9.0	3.48	3569	3900	
	114.5	26.2	7.50	2651	13.1	4.42	3124	8.7	3.02	3204	3530	
	117.0	25.6	7.38	2669	12.8	4.33	3129	8.5	2.96	3209	3530	
	123.9	24.2	7.22	2761	12.1	4.44	3400	8.1	3.13	3594	3900	
	128.1	23.4	6.93	2742	11.7	3.98	3146	7.8	2.72	3227	3530	
	130.5	23.0	6.84	2757	11.5	3.91	3150	7.7	2.67	3231	3530	
	141.2	21.2	6.58	2872	10.6	4.05	3533	7.1	2.77	3624	3900	
	146.2	20.5	6.32	2853	10.3	3.51	3172	6.8	2.40	3254	3530	
	152.2	19.7	6.25	2938	9.9	3.66	3442	6.6	2.44	3442	3900	
157.4	19.1	6.00	2917	9.5	3.28	3187	6.4	2.24	3269	3530		
166.7	18.0	5.76	2967	9.0	3.11	3198	6.0	2.12	3281	3530		
179.7	16.7	5.47	3035	8.3	2.89	3214	5.6	1.98	3296	3530		
189.5	15.8	4.62	2703	7.9	2.41	2822	5.3	1.65	2895	3130		
200.6	15.0	4.38	2712	7.5	2.29	2832	5.0	1.56	2905	3130		
216.3	13.9	4.08	2725	6.9	2.13	2846	4.6	1.46	2919	3130		
PH413	RAPPORTI DA 185 A 1700, COPPIA D'USCITA NOMINALE 3800Nm / 4500Nm a 1500rpm											11
	CONTATTARE IL NOSTRO SERVIZIO TECNICO COMMERCIALE PER EVENTUALI RICHIESTE											
	RATIOS FROM 185 TO 1700, RATED TORQUE 3800Nm / 4500Nm at 1500 rpm											
	FOR REQUESTS CONTACT OUR TECHNICAL SERVICE											

(*) PER POSIZIONI DI MONTAGGIO V5 / V6 P_T=15kW - FOR MOUNTING POSITION V5 / V6 P_T=15kW



Planetary helical gearboxes

PH.16

	EX	n ₁ = 3000 min ⁻¹			n ₁ = 1500 min ⁻¹			n ₁ = 1000 min ⁻¹			10000 HOURS LIFE	
		i _{eff}	n ₂ [min ⁻¹]	P _{N1} [kW]	T _{N2} [Nm]	n ₂ [min ⁻¹]	P _{N1} [kW]	T _{N2} [Nm]	n ₂ [min ⁻¹]	P _{N1} [kW]	T _{N2} [Nm]	T _{2iso} [Nm]
PH216	13.92	216	26.9	1167	108	16.5	1436	72	12.5	1622	3900	22 (*)
	16.43	183	26.9	1377	91	16.5	1695	61	12.5	1915	4600	
	18.68	161	26.2	1527	80	16.1	1880	54	12.1	2123	5100	
	19.77	152	26.9	1658	76	16.5	2041	51	12.5	2305	5000	
	22.48	133	26.2	1838	67	16.1	2262	44	12.1	2555	5000	
	25.62	117	23.5	1880	59	14.5	2315	39	10.9	2614	5000	
	27.63	109	22.1	1906	54	13.6	2347	36	10.2	2650	5000	
	33.20	90	19.1	1976	45	11.7	2433	30	8.8	2747	4200	
	37.16	81	17.5	2025	40	10.8	2493	27	8.1	2816	3600	
	42.41	71	15.8	2096	35	9.4	2477	24	6.2	2477	3100	
PH316	50.79	59.1	13.16	2064	29.5	8.10	2542	19.7	6.10	2870	4600	15
	57.75	51.9	12.83	2289	26.0	7.90	2818	17.3	5.95	3182	5100	
	59.95	50.0	13.16	2437	25.0	8.10	3000	16.7	6.10	3388	5500	
	68.16	44.0	12.50	2632	22.0	7.70	3240	14.7	5.79	3659	5800	
	77.50	38.7	11.43	2735	19.4	7.03	3368	12.9	5.30	3803	5800	
	88.33	34.0	10.43	2845	17.0	6.42	3502	11.3	4.83	3955	5800	
	95.24	31.5	9.89	2910	15.7	6.09	3582	10.5	4.58	4046	5800	
	114.5	26.2	8.70	3075	13.1	5.35	3786	8.7	4.03	4275	5800	
	128.1	23.4	8.04	3180	11.7	4.95	3916	7.8	3.72	4422	5800	
	146.2	20.5	7.33	3309	10.3	4.51	4074	6.8	3.40	4601	5800	
	157.1	19.1	6.80	3301	9.6	4.19	4064	6.4	3.15	4590	5000	
	175.8	17.1	6.29	3414	8.5	3.87	4204	5.7	2.84	4622	5000	
	200.6	15.0	5.73	3553	7.5	3.53	4374	5.0	2.51	4661	5000	
216.3	13.9	5.44	3634	6.9	3.35	4474	4.6	2.34	4683	5000		
PH416	218.8	13.7	5.37	3593	6.9	3.26	4357	4.6	2.22	4447	5500	11
	248.8	12.1	5.10	3881	6.0	3.14	4778	4.0	2.17	4943	5800	
	282.9	10.6	4.66	4034	5.3	2.81	4858	3.5	1.92	4983	5800	
	299.5	10.0	4.37	4006	5.0	2.54	4659	3.3	1.74	4779	5000	
	340.5	8.8	4.00	4164	4.4	2.26	4697	2.9	1.54	4817	5000	
	387.1	7.7	3.66	4327	3.9	2.00	4734	2.6	1.37	4856	5000	
	441.3	6.8	3.34	4500	3.4	1.77	4773	2.3	1.21	4896	5000	
	502.9	6.0	3.00	4609	3.0	1.56	4813	2.0	1.07	4936	5000	
	542.3	5.5	2.79	4630	2.8	1.46	4835	1.8	1.00	4959	5000	
	651.8	4.6	2.35	4684	2.3	1.23	4891	1.5	0.84	5018	5000	
	702.8	4.3	2.19	4706	2.1	1.14	4914	1.4	0.79	5075	5000	
	844.7	3.6	1.84	4760	1.8	0.96	4971	1.2	0.67	5219	5000	
	945.3	3.2	1.66	4794	1.6	0.87	5006	1.1	0.61	5308	5000	
	1079	2.8	1.47	4834	1.4	0.77	5093	0.9	0.55	5416	5000	
	1230	2.4	1.30	4873	1.2	0.69	5195	0.8	0.49	5524	5000	
	1376	2.2	1.17	4908	1.1	0.63	5284	0.7	0.45	5619	5000	
	1571	1.9	1.03	4948	1.0	0.56	5391	0.6	0.40	5732	5000	
1694	1.8	0.96	4972	0.9	0.51	5319	0.6	0.35	5455	5000		

(*) PER POSIZIONI DI MONTAGGIO V5 / V6 P_T=15kW - FOR MOUNTING POSITION V5 / V6 P_T=15kW
 HIGHER RATIOS ARE AVAILABLE
 CONTACT OUR TECHNICAL SERVICE FOR POSSIBLE QUESTIONS



Planetary helical gearboxes

PH.18

Epsilon	n ₁ = 3000 min ⁻¹			n ₁ = 1500 min ⁻¹			n ₁ = 1000 min ⁻¹			10000 HOURS LIFE		
	i _{eff}	n ₂ [min ⁻¹]	P _{N1} [kW]	T _{N2} [Nm]	n ₂ [min ⁻¹]	P _{N1} [kW]	T _{N2} [Nm]	n ₂ [min ⁻¹]	P _{N1} [kW]	T _{N2} [Nm]	T _{ISO} [Nm]	P _T [kW]
PH218	13.92	216	38.3	1663	108	23.6	2047	72	17.7	2312	5800	30 (*)
	16.43	183	38.3	1963	91	23.6	2416	61	17.7	2729	6800	
	18.68	161	36.9	2149	80	22.7	2646	54	17.1	2988	7600	
	19.77	152	38.3	2362	76	23.6	2908	51	17.7	3285	6600	
	22.48	133	36.8	2579	67	22.6	3175	44	17.0	3586	6600	
	25.62	117	33.1	2649	59	20.4	3261	39	15.4	3683	6600	
	27.63	109	31.1	2682	54	19.2	3302	36	14.4	3729	6600	
	33.20	90	26.9	2784	45	16.5	3427	30	12.5	3871	6300	
	37.16	81	24.6	2850	40	15.1	3508	27	11.4	3962	5500	
	42.41	71	22.3	2948	35	13.7	3630	24	9.4	3740	4700	
PH318	50.79	59.1	18.75	2942	29.5	11.54	3622	19.7	8.69	4091	6900	22
	57.75	51.9	18.06	3222	26.0	11.12	3967	17.3	8.37	4480	7700	
	59.95	50.0	18.75	3473	25.0	11.54	4276	16.7	8.69	4829	7700	
	68.16	44.0	17.50	3684	22.0	10.77	4535	14.7	8.11	5122	7700	
	77.50	38.7	15.99	3828	19.4	9.84	4713	12.9	7.41	5323	7700	
	88.33	34.0	14.59	3982	17.0	8.98	4902	11.3	6.76	5536	7700	
	95.24	31.5	13.84	4073	15.7	8.52	5014	10.5	6.42	5663	7700	
	114.5	26.2	12.17	4304	13.1	7.49	5298	8.7	5.64	5984	7700	
	128.1	23.4	11.25	4451	11.7	6.92	5480	7.8	5.21	6189	7700	
	146.2	20.5	10.25	4632	10.3	6.31	5702	6.8	4.75	6440	7700	
	166.7	18.0	9.36	4817	9.0	5.76	5930	6.0	4.18	6450	7700	
	176.0	17.0	8.80	4782	8.5	5.41	5887	5.7	3.74	6100	6600	
	200.6	15.0	8.03	4973	7.5	4.84	5996	5.0	3.31	6150	6600	
	216.3	13.9	7.61	5087	6.9	4.51	6025	4.6	3.08	6179	6600	
PH418	218.8	13.7	7.65	5121	6.9	4.71	6305	4.6	3.30	6626	7700	15
	248.8	12.1	7.14	5432	6.0	4.40	6688	4.0	3.19	7288	7700	
	282.9	10.6	6.53	5646	5.3	4.02	6950	3.5	2.83	7347	7700	
	321.6	9.3	5.97	5867	4.7	3.67	7221	3.1	2.51	7406	7700	
	366.6	8.2	5.44	6102	4.1	3.25	7280	2.7	2.22	7467	7700	
	395.3	7.6	5.16	6242	3.8	3.03	7315	2.5	2.07	7502	7700	
	417.8	7.2	4.97	6346	3.6	2.87	7340	2.4	1.96	7528	7700	
	450.5	6.7	4.71	6491	3.3	2.68	7375	2.2	1.83	7564	7700	
	475.1	6.3	4.54	6596	3.2	2.55	7399	2.1	1.74	7589	7700	
	541.5	5.5	4.14	6860	2.8	2.25	7460	1.8	1.54	7653	7700	
	583.8	5.1	3.93	7016	2.6	2.10	7495	1.7	1.45	7741	7700	
	606.0	5.0	3.83	7095	2.5	2.03	7512	1.7	1.40	7785	7700	
	653.4	4.6	3.62	7228	2.3	1.89	7548	1.5	1.31	7836	7700	
	691.6	4.3	3.43	7254	2.2	1.79	7575	1.4	1.24	7864	7700	
	745.7	4.0	3.20	7288	2.0	1.67	7611	1.3	1.15	7901	7700	
	785.3	3.8	3.04	7312	1.9	1.59	7635	1.3	1.10	7927	7700	
	896.4	3.3	2.69	7372	1.7	1.42	7768	1.1	0.97	7993	7700	
	1003.1	3.0	2.42	7424	1.5	1.28	7848	1.0	0.87	8049	7700	
	1143	2.6	1.91	6671	1.3	1.00	6966	0.9	0.68	7145	7700	
	1233	2.4	1.70	6398	1.2	0.89	6681	0.8	0.61	6853	7700	
1407	2.1	1.50	6451	1.1	0.78	6737	0.7	0.54	6910	7700		
1571	1.9	1.36	6530	1.0	0.74	7114	0.6	0.52	7564	6600		
1694	1.8	1.27	6561	0.9	0.69	7196	0.6	0.49	7651	6600		

(*) PER POSIZIONI DI MONTAGGIO V5 / V6 P_T=22kW - FOR MOUNTING POSITION V5 / V6 P_T=22kW
 HIGHER RATIOS ARE AVAILABLE
 CONTACT OUR TECHNICAL SERVICE FOR POSSIBLE QUESTIONS



Planetary helical gearboxes

PH.20

		$n_1= 3000 \text{ min}^{-1}$			$n_1= 1500 \text{ min}^{-1}$			$n_1= 1000 \text{ min}^{-1}$			10000 HOURS LIFE	
		i_{eff}	n_2 [min ⁻¹]	P_{N1} [kW]	T_{N2} [Nm]	n_2 [min ⁻¹]	P_{N1} [kW]	T_{N2} [Nm]	n_2 [min ⁻¹]	P_{N1} [kW]	T_{N2} [Nm]	$T_{2\text{iso}}$ [Nm]
PH220	11.74	255	53.3	1954	128	32.8	2405	85	24.7	2716	8100	37 (*)
	13.86	216	53.3	2306	108	32.8	2839	72	24.7	3206	9500	
	15.75	190	51.3	2523	95	31.6	3106	63	23.8	3508	9300	
	18.59	161	45.0	2608	81	27.7	3211	54	20.8	3626	8500	
	23.27	129	37.4	2713	64	23.0	3341	43	17.3	3773	7200	
	27.00	111	33.2	2794	56	20.4	3440	37	15.4	3885	6700	
	32.63	92	28.3	2882	46	17.4	3548	31	13.1	4007	5800	
PH320	39.69	75.6	22.43	2750	37.8	13.81	3386	25.2	10.40	3824	10900	30
	46.85	64.0	22.43	3246	32.0	13.81	3996	21.3	10.40	4513	10100	
	53.24	56.4	22.43	3689	28.2	13.81	4541	18.8	10.40	5129	10100	
	62.82	47.8	20.81	4038	23.9	12.81	4972	15.9	9.65	5615	10100	
	69.14	43.4	18.17	3881	21.7	11.19	4777	14.5	8.42	5395	10100	
	78.64	38.2	17.78	4320	19.1	10.95	5318	12.7	8.24	6006	9000	
	81.59	36.8	17.33	4368	18.4	10.67	5377	12.3	8.03	6073	10100	
	94.50	31.7	14.13	4125	15.9	8.70	5078	10.6	6.55	5735	10100	
	111.5	26.9	13.93	4797	13.5	8.57	5906	9.0	6.45	6670	10100	
	129.0	23.3	12.54	4996	11.6	7.72	6151	7.8	5.81	6946	10100	
	139.6	21.5	11.90	5131	10.7	7.33	6317	7.2	5.52	7134	9000	
	161.5	18.6	10.75	5360	9.3	6.62	6599	6.2	4.78	7155	9000	
	PH420	134.2	22.4	9.66	3963	11.2	5.95	4879	7.5	4.48	5510	
158.3		18.9	9.66	4678	9.5	5.95	5759	6.3	4.48	6504	10100	
179.9		16.7	9.66	5315	8.3	5.95	6544	5.6	4.48	7391	10100	
205.7		14.6	8.04	5059	7.3	4.95	6229	4.9	3.73	7034	10100	
233.7		12.8	8.04	5749	6.4	4.95	7078	4.3	3.73	7994	10100	
267.1		11.2	6.52	5322	5.6	4.01	6553	3.7	3.02	7400	10100	
281.1		10.7	6.46	5556	5.3	3.98	6841	3.6	3.00	7726	10100	
303.5		9.9	6.52	6048	4.9	4.01	7446	3.3	3.02	8409	10100	
319.4		9.4	6.46	6314	4.7	3.98	7774	3.1	3.00	8779	10100	
369.5		8.1	5.84	6596	4.1	3.59	8121	2.7	2.71	9171	10100	
414.9		7.2	5.24	6643	3.6	3.22	8178	2.4	2.43	9236	10100	
436.0		6.9	5.42	7221	3.4	3.28	8746	2.3	2.24	8971	10100	
479.8		6.3	4.73	6939	3.1	2.91	8543	2.1	2.19	9648	10100	
559.0		5.4	4.37	7468	2.7	2.69	9195	1.8	1.98	10174	10100	
638.9		4.7	3.54	6914	2.3	2.18	8512	1.6	1.64	9613	10100	
726.0		4.1	3.54	7857	2.1	2.18	9673	1.4	1.59	10584	10100	
773.9		3.9	3.62	8578	1.9	1.92	9066	1.3	1.31	9299	10100	
856.7		3.5	3.34	8737	1.8	1.74	9124	1.2	1.19	9358	10100	
895.1		3.4	3.20	8761	1.7	1.62	8849	1.1	1.08	8849	10100	
992		3.0	2.71	8227	1.5	1.36	8227	1.0	0.92	8350	10100	
1148		2.6	2.14	7499	1.3	1.07	7499	0.9	0.72	7604	9400	
1171		2.6	2.49	8909	1.3	1.30	9304	0.9	0.89	9542	10100	
1354		2.2	2.14	8849	1.1	1.07	8849	0.7	0.72	8973	10100	
1695	1.8	1.45	7532	0.9	0.76	7865	0.6	0.52	8067	9000		

(*) PER POSIZIONI DI MONTAGGIO V5 / V6 $P_T=30\text{kW}$ - FOR MOUNTING POSITION V5 / V6 $P_T=30\text{kW}$
 HIGHER RATIOS ARE AVAILABLE
 CONTACT OUR TECHNICAL SERVICE FOR POSSIBLE QUESTIONS



Planetary helical gearboxes

PH.23

EX	n ₁ = 3000 min ⁻¹			n ₁ = 1500 min ⁻¹			n ₁ = 1000 min ⁻¹			10000 HOURS LIFE		
	i _{eff}	n ₂ [min ⁻¹]	P _{N1} [kW]	T _{N2} [Nm]	n ₂ [min ⁻¹]	P _{N1} [kW]	T _{N2} [Nm]	n ₂ [min ⁻¹]	P _{N1} [kW]	T _{N2} [Nm]	T _{2ISO} [Nm]	P _T [kW]
PH223	11.96	251	85.8	3201	125	52.8	3941	84	39.7	4451	11710	45 (*)
	13.92	216	85.8	3723	108	52.8	4584	72	39.7	5177	13600	
	16.43	183	82.6	4233	91	50.8	5211	61	38.3	5885	15100	
	18.68	161	75.5	4399	80	46.5	5416	54	35.0	6116	15100	
	21.29	141	68.9	4575	70	42.4	5632	47	31.9	6361	15100	
	22.95	131	65.4	4679	65	40.2	5761	44	30.3	6506	15100	
	27.59	109	57.5	4945	54	35.4	6088	36	26.6	6875	12400	
	30.87	97	53.1	5115	49	32.7	6297	32	24.6	7111	10800	
PH323	50.79	59.1	38.30	6008	29.5	23.57	7397	19.7	17.75	8354	16400	37
	57.75	51.9	35.19	6277	26.0	21.66	7727	17.3	16.31	8727	16700	
	65.66	45.7	32.16	6523	22.8	19.80	8031	15.2	14.91	9069	16700	
	74.84	40.1	29.35	6784	20.0	18.07	8352	13.4	13.60	9432	16700	
	80.69	37.2	27.84	6939	18.6	17.14	8543	12.4	12.90	9648	16700	
	88.33	34.0	25.70	7011	17.0	15.82	8632	11.3	11.91	9748	15100	
	100.68	29.8	23.45	7292	14.9	14.43	8977	9.9	10.87	10139	15100	
	108.55	27.6	22.24	7458	13.8	13.69	9182	9.2	10.31	10370	15100	
	130.5	23.0	19.56	7882	11.5	12.04	9703	7.7	9.06	10959	15100	
	146.0	20.5	18.08	8152	10.3	11.13	10037	6.8	8.38	11335	15100	
	157.4	19.1	17.15	8339	9.5	10.56	10266	6.4	7.95	11594	15100	
	166.7	18.0	16.48	8482	9.0	10.14	10443	6.0	7.64	11794	13200	
	179.7	16.7	15.63	8676	8.3	9.62	10681	5.6	7.24	12063	13200	
PH423	185.4	16.2	15.63	8860	8.1	9.62	10908	5.4	7.24	12319	16400	30
	218.8	13.7	13.76	9204	6.9	8.47	11332	4.6	6.38	12797	15100	
	248.8	12.1	12.57	9566	6.0	7.74	11777	4.0	5.83	13300	15100	
	282.9	10.6	11.49	9941	5.3	7.07	12239	3.5	5.33	13822	15100	
	321.6	9.3	10.50	10332	4.7	6.47	12720	3.1	4.87	14365	15100	
	347.6	8.6	9.95	10575	4.3	6.12	13020	2.9	4.61	14704	15100	
	366.6	8.2	9.59	10745	4.1	5.90	13229	2.7	4.40	14780	15100	
	395.3	7.6	9.09	10991	3.8	5.60	13531	2.5	4.10	14850	15100	
	417.8	7.2	8.75	11175	3.6	5.38	13758	2.4	3.89	14902	15100	
	450.5	6.7	8.30	11431	3.3	5.11	14073	2.2	3.62	14972	15100	
	475.1	6.3	7.99	11614	3.2	4.92	14299	2.1	3.45	15022	15100	
	485.7	6.2	7.87	11692	3.1	4.85	14394	2.1	3.38	15043	15100	
	541.5	5.5	7.30	12079	2.8	4.46	14766	1.8	3.05	15149	15100	
	606.0	5.0	6.74	12494	2.5	4.01	14870	1.7	2.77	15409	15100	
	653.4	4.6	6.40	12779	2.3	3.74	14940	1.5	2.60	15585	15100	
	691.6	4.3	6.15	12999	2.2	3.54	14994	1.4	2.48	15720	15100	
	785.3	3.8	5.62	13504	1.9	3.15	15113	1.3	2.22	16025	15100	
	896.4	3.3	5.13	14051	1.7	2.80	15376	1.1	1.99	16349	15100	
	1021.6	2.9	4.68	14613	1.5	2.51	15684	1.0	1.78	16676	15100	
	1143	2.6	4.24	14816	1.3	2.28	15953	0.9	1.61	16893	15100	
1233	2.4	3.95	14886	1.2	2.06	15547	0.8	1.41	15946	15100		
1407	2.1	3.49	15010	1.1	1.82	15676	0.7	1.22	15690	15100		

(*) PER POSIZIONI DI MONTAGGIO V5 / V6 P_T=40kW - FOR MOUNTING POSITION V5 / V6 P_T=40kW
 HIGHER RATIOS ARE AVAILABLE
 CONTACT OUR TECHNICAL SERVICE FOR POSSIBLE QUESTIONS



Planetary helical gearboxes

PH.25

		$n_1= 3000 \text{ min}^{-1}$			$n_1= 1500 \text{ min}^{-1}$			$n_1= 1000 \text{ min}^{-1}$			10000 HOURS LIFE	
		i_{eff}	n_2 [min^{-1}]	P_{N1} [kW]	T_{N2} [Nm]	n_2 [min^{-1}]	P_{N1} [kW]	T_{N2} [Nm]	n_2 [min^{-1}]	P_{N1} [kW]	T_{N2} [Nm]	T_{2iso} [Nm]
PH225	13.34	225	118.4	4928	112	72.9	6067	75	54.9	6852	24200	60 (*)
	14.72	204	110.5	5072	102	68.0	6244	68	51.2	7052	22400	
	15.75	190	118.4	5817	95	72.9	7161	63	54.9	8087	22000	
	17.37	173	110.5	5986	86	68.0	7370	58	51.2	8324	22000	
	19.49	154	100.2	6089	77	61.7	7496	51	46.4	8466	22000	
	22.50	133	88.8	6231	67	54.6	7672	44	41.1	8664	22000	
	27.00	111	77.1	6495	56	47.5	7996	37	35.7	9030	20400	
PH325	46.70	64.2	49.75	7176	32.1	30.62	8835	21.4	23.06	9978	24200	45
	51.51	58.2	46.42	7386	29.1	28.58	9093	19.4	21.52	10269	22400	
	55.13	54.4	49.75	8470	27.2	30.62	10428	18.1	23.06	11777	22000	
	65.05	46.1	44.30	8901	23.1	27.27	10959	15.4	20.53	12376	22000	
	71.74	41.8	41.34	9161	20.9	25.45	11279	13.9	19.16	12738	22000	
	81.43	36.8	37.86	9522	18.4	23.30	11723	12.3	17.55	13239	22000	
	89.80	33.4	35.33	9800	16.7	21.75	12065	11.1	16.37	13626	22000	
	104.22	28.8	31.83	10247	14.4	19.60	12616	9.6	14.75	14248	22000	
	116.9	25.7	28.86	10423	12.8	17.77	12832	8.6	13.38	14492	22000	
	125.9	23.8	27.88	10846	11.9	17.16	13353	7.9	12.92	15080	22000	
	141.3	21.2	25.28	11032	10.6	15.56	13582	7.1	11.72	15338	22000	
	163.1	18.4	22.41	11290	9.2	13.79	13899	6.1	10.38	15697	22000	
	195.8	15.3	19.46	11767	7.7	11.98	14487	5.1	8.99	16306	20400	
PH425	169.8	17.7	22.86	11870	8.8	14.07	14614	5.9	10.60	16504	22000	37
	200.3	15.0	20.36	12474	7.5	12.53	15358	5.0	9.44	17344	22000	
	227.7	13.2	18.62	12962	6.6	11.46	15958	4.4	8.63	18022	22000	
	250.8	12.0	17.40	13344	6.0	10.71	16428	4.0	8.06	18553	22000	
	268.6	11.2	16.58	13622	5.6	10.21	16771	3.7	7.69	18940	22000	
	285.0	10.5	15.91	13865	5.3	9.79	17070	3.5	7.37	19278	22000	
	330.8	9.1	14.34	14499	4.5	8.82	17850	3.0	6.64	20159	22000	
	336.3	8.9	14.17	14571	4.5	8.72	17939	3.0	6.57	20260	22000	
	390.3	7.7	12.77	15237	3.8	7.86	18759	2.6	5.92	21185	22000	
	421.0	7.1	12.11	15587	3.6	7.45	19190	2.4	5.61	21672	22000	
	471.6	6.4	11.18	16127	3.2	6.88	19855	2.1	5.05	21842	22000	
	488.6	6.1	10.91	16299	3.1	6.72	20066	2.0	4.88	21890	22000	
	567.0	5.3	9.83	17043	2.6	6.05	20983	1.8	4.27	22191	22000	
	590.3	5.1	9.56	17251	2.5	5.88	21239	1.7	4.12	22327	22000	
	685.1	4.4	8.61	18039	2.2	5.20	21798	1.5	3.63	22835	22000	
	755.6	4.0	8.04	18566	2.0	4.75	21932	1.3	3.34	23176	22000	
	827.9	3.6	7.54	19093	1.8	4.37	22100	1.2	3.09	23498	22000	
	913.0	3.3	7.04	19651	1.6	4.02	22430	1.1	2.85	23849	22000	
	1024	2.9	6.38	19987	1.5	3.64	22823	1.0	2.54	23867	22000	
	1183	2.5	5.66	20454	1.3	3.08	22295	0.8	2.11	22868	22000	
1419	2.1	3.94	17090	1.1	2.06	17846	0.7	1.41	18304	20400		

(*) PER POSIZIONI DI MONTAGGIO V5 / V6 $P_T=55\text{kW}$ - FOR MOUNTING POSITION V5 / V6 $P_T=55\text{kW}$
 HIGHER RATIOS ARE AVAILABLE
 CONTACT OUR TECHNICAL SERVICE FOR POSSIBLE QUESTIONS



Planetary helical gearboxes

PH.28

		$n_1= 3000 \text{ min}^{-1}$			$n_1= 1500 \text{ min}^{-1}$			$n_1= 1000 \text{ min}^{-1}$			10000 HOURS LIFE		
		i_{eff}	n_2 [min ⁻¹]	P_{N1} [kW]	T_{N2} [Nm]	n_2 [min ⁻¹]	P_{N1} [kW]	T_{N2} [Nm]	n_2 [min ⁻¹]	P_{N1} [kW]	T_{N2} [Nm]	T_{2ISO} [Nm]	P_T [kW]
PH228		18.4	163	133.0	7620	82	81.9	9381	54	61.7	10595	34400	90 (*)
		22.7	132	111.8	7925	66	68.8	9757	44	51.8	11019	35600	
		26.1	115	99.3	8102	57	61.1	9975	38	46.0	11266	32000	
PH328		64.3	46.7	55.90	11096	23.3	34.41	13661	15.6	25.91	15428	35700	80
		75.8	39.6	49.79	11661	19.8	30.65	14356	13.2	23.07	16213	35700	
		79.5	37.7	46.98	11541	18.9	28.92	14209	12.6	21.77	16046	35600	
		91.5	32.8	41.74	11799	16.4	25.70	14526	10.9	19.35	16405	32000	
		93.9	32.0	41.84	12128	16.0	25.75	14932	10.7	19.39	16863	35600	
		94.9	31.6	42.54	12474	15.8	26.19	15357	10.5	19.72	17343	35700	
		108.0	27.8	37.18	12399	13.9	22.89	15265	9.3	17.23	17240	32000	
		110.2	27.2	38.33	13043	13.6	23.60	16058	9.1	17.77	18135	35700	
		117.5	25.5	35.75	12974	12.8	22.01	15973	8.5	16.57	18039	35600	
		133.1	22.5	33.58	13805	11.3	20.67	16996	7.5	15.56	19195	35700	
		135.2	22.2	31.77	13264	11.1	19.56	16329	7.4	14.72	18442	32000	
		136.4	22.0	32.21	13566	11.0	19.83	16702	7.3	14.93	18863	35600	
		156.9	19.1	28.62	13869	9.6	17.62	17075	6.4	13.27	19284	32000	
		164.8	18.2	28.22	14359	9.1	17.37	17678	6.1	13.08	19964	35600	
		189.6	15.8	25.07	14680	7.9	15.43	18073	5.3	11.62	20410	32000	
PH428		197.9	15.2	25.69	15550	7.6	15.82	19144	5.1	11.91	21621	35700	75
		224.9	13.3	23.49	16158	6.7	14.46	19893	4.4	10.89	22466	35700	
		265.4	11.3	20.92	16980	5.7	12.88	20905	3.8	9.70	23609	35700	
		278.4	10.8	19.74	16806	5.4	12.15	20690	3.6	9.15	23367	35600	
		292.4	10.3	19.55	17481	5.1	12.04	21521	3.4	9.06	24305	35700	
		332.2	9.0	17.88	18164	4.5	11.01	22363	3.0	8.29	25255	35700	
		361.9	8.3	16.43	18182	4.1	10.11	22384	2.8	7.62	25280	35600	
		385.6	7.8	16.11	18994	3.9	9.92	23384	2.6	7.47	26409	35700	
		392.0	7.7	15.92	19089	3.8	9.80	23501	2.6	7.38	26541	35700	
		411.2	7.3	15.02	18892	3.6	9.25	23259	2.4	6.96	26268	35600	
		465.9	6.4	14.11	20103	3.2	8.69	24750	2.1	6.54	27951	35700	
		490.7	6.1	13.61	20419	3.1	8.38	25139	2.0	6.31	28391	35700	
		549.7	5.5	12.57	21127	2.7	7.74	26010	1.8	5.82	29374	35700	
		569.5	5.3	12.26	21352	2.6	7.55	26287	1.8	5.68	29687	35700	
		607.4	4.9	11.43	21238	2.5	7.04	26147	1.6	5.30	29529	35600	
		661.0	4.5	11.05	22327	2.3	6.80	27488	1.5	5.12	31044	35700	
		688.2	4.4	10.74	22599	2.2	6.61	27823	1.5	4.98	31422	35700	
		704.9	4.3	10.30	22208	2.1	6.34	27341	1.4	4.77	30878	35600	
		798.7	3.8	9.68	23631	1.9	5.96	29094	1.3	4.48	32857	35700	
		818.1	3.7	9.28	23223	1.8	5.71	28590	1.2	4.16	31230	35600	
		965.0	3.1	8.48	25012	1.6	5.22	30793	1.0	3.92	34693	35700	
	988.5	3.0	8.13	24579	1.5	5.01	30260	1.0	3.48	31602	35600		
	1194.5	2.5	7.12	26015	1.3	4.27	31178	0.8	2.92	31978	35600		
	1374.2	2.2	6.33	26596	1.1	3.33	27980	0.7	2.28	28698	32000		

(*) PER POSIZIONI DI MONTAGGIO V5 / V6 $P_T=75\text{kW}$ - FOR MOUNTING POSITION V5 / V6 $P_T=75\text{kW}$
OTHER RATIOS ARE POSSIBLE. FOR SPECIAL REQUESTS PLEASE CONTACT OUR TECHNICAL SERVICE



Bevel planetary helical gearboxes

BPH.13

	EX	n ₁ = 3000 min ⁻¹			n ₁ = 1500 min ⁻¹			n ₁ = 1000 min ⁻¹			10000 HOURS LIFE	
		i _{eff}	n ₂ [min ⁻¹]	P _{N1} [kW]	T _{N2} [Nm]	n ₂ [min ⁻¹]	P _{N1} [kW]	T _{N2} [Nm]	n ₂ [min ⁻¹]	P _{N1} [kW]	T _{N2} [Nm]	T _{2iso} [Nm]
BPH213 BPW213	9.7	311	30.0	899	155	19.0	1140	104	14.6	1313	3900	18.5 (*)
	11.4	263	30.0	1062	132	19.0	1345	88	14.6	1550	3530	
	13.7	219	30.0	1278	109	19.0	1644	73	14.6	1866	3130	
	17.0	177	18.7	986	88	11.9	1254	59	9.0	1420	3180	
	20.0	150	18.7	1180	75	11.9	1480	50	9.0	1680	3530	
	24.1	124	18.7	1400	62	11.9	1783	41	9.0	2022	3130	
	27.5	109	12.9	1100	55	8.1	1383	36	6.2	1588	2730	
	33.1	91	12.9	1326	45	8.1	1665	30	6.2	1910	3130	
BPH313 - BPW313	35.3	85.1	17.77	1926	42.5	10.94	2371	28.4	8.24	2677	3900	16
	40.1	74.8	16.25	2001	37.4	10.00	2464	24.9	7.53	2783	3900	
	45.7	65.7	14.83	2081	32.8	9.13	2563	21.9	6.87	2894	3900	
	49.3	60.9	14.06	2129	30.5	8.66	2621	20.3	6.52	2960	3900	
	53.9	55.6	13.37	2216	27.8	8.23	2729	18.5	6.15	3057	3500	
	59.2	50.7	12.36	2250	25.3	7.61	2770	16.9	5.73	3128	3900	
	66.3	45.3	11.43	2327	22.6	7.03	2865	15.1	5.30	3235	3900	
	75.6	39.7	10.42	2421	19.8	6.41	2981	13.2	4.83	3366	3900	
	83.2	36.1	9.40	2365	18.0	5.69	2912	12.0	3.83	3038	3500	
	89.3	33.6	9.25	2578	16.8	5.61	3076	11.2	3.96	3155	3500	
	94.8	31.6	8.44	2460	15.8	5.14	2995	10.5	3.50	3063	3500	
	102.2	29.3	8.01	2516	14.7	4.77	3000	9.8	3.26	3077	3500	
	114.1	26.3	7.47	2618	13.1	3.90	2734	8.8	2.67	2804	3100	
	122.9	24.4	7.04	2659	12.2	4.02	3035	8.1	2.75	3113	3500	
	137.5	21.8	6.51	2750	10.9	3.62	3056	7.3	2.47	3135	3500	
	157.0	19.1	5.93	2861	9.6	3.19	3082	6.4	2.18	3161	3500	
	165.5	18.1	5.27	2680	9.1	2.75	2798	6.0	1.88	2870	3100	
	188.9	15.9	4.65	2702	7.9	2.43	2822	5.3	1.66	2894	3100	
	202.9	14.8	4.22	2629	7.4	2.14	2664	4.9	1.46	2732	3100	
	227.1	13.2	3.77	2629	6.6	1.92	2682	4.4	1.31	2751	3100	
259.2	11.6	3.30	2629	5.8	1.70	2705	3.9	1.16	2774	3100		
BPH413 - BPW413	128.7	23.3	7.25	2840	11.7	4.47	3496	7.8	3.07	3603	3900	15
	146.3	20.5	6.63	2951	10.3	3.98	3541	6.8	2.72	3632	3900	
	166.3	18.0	6.06	3067	9.0	3.53	3570	6.0	2.41	3661	3900	
	189.6	15.8	5.53	3190	7.9	3.12	3599	5.3	2.13	3691	3900	
	204.4	14.7	5.25	3263	7.3	2.91	3616	4.9	1.99	3709	3900	
	233.0	12.9	4.79	3393	6.4	2.57	3646	4.3	1.76	3739	3900	
	251.2	11.9	4.54	3471	6.0	2.40	3663	4.0	1.64	3757	3900	
	280.0	10.7	4.14	3531	5.4	2.16	3688	3.6	1.48	3782	3900	
	313.4	9.6	3.73	3556	4.8	1.95	3714	3.2	1.33	3809	3900	
	362.9	8.3	3.25	3589	4.1	1.70	3748	2.8	1.16	3844	3900	
	406.2	7.4	2.92	3614	3.7	1.53	3774	2.5	1.04	3871	3900	
	454.5	6.6	2.63	3640	3.3	1.37	3801	2.2	0.94	3899	3900	
	501.9	6.0	2.08	3173	3.0	1.09	3314	2.0	0.74	3399	3500	
	547.2	5.5	1.98	3299	2.7	1.03	3445	1.8	0.71	3538	3500	
	570.7	5.3	1.84	3199	2.6	0.96	3341	1.8	0.66	3426	3500	
	626.7	4.8	1.69	3218	2.4	0.88	3360	1.6	0.60	3446	3500	
	701.3	4.3	1.52	3240	2.1	0.79	3384	1.4	0.54	3471	3500	
	742.4	4.0	1.44	3252	2.0	0.75	3396	1.3	0.51	3483	3500	
	800.5	3.7	1.34	3267	1.9	0.70	3412	1.2	0.48	3500	3500	
	943.3	3.2	1.15	3301	1.6	0.60	3447	1.1	0.41	3536	3500	
	962.1	3.1	1.13	3305	1.6	0.59	3451	1.0	0.40	3540	3500	
	1076.7	2.8	1.02	3328	1.4	0.53	3476	0.9	0.36	3565	3500	
	1229.0	2.4	0.90	3356	1.2	0.47	3505	0.8	0.32	3595	3500	
	1392.0	2.2	0.68	2877	1.1	0.35	3004	0.7	0.24	3081	3100	
	1479.3	2.0	0.68	3073	1.0	0.37	3330	0.7	0.26	3541	3100	
	1588.8	1.9	0.60	2901	0.9	0.31	3029	0.6	0.21	3107	3100	
	1778.0	1.7	0.54	2921	0.8	0.28	3051	0.6	0.19	3129	3100	
	2029.4	1.5	0.48	2946	0.7	0.25	3076	0.5	0.17	3155	3100	

(*) PER POSIZIONI DI MONTAGGIO IN CUI E' PREVISTO L'USO DEL VASO D'ESPANSIONE P_T=15kW , RIFERIMENTO TABELLA PAGINA 7
 FOR MOUNTING POSITION WITH OIL TANK P_T=15kW , REFERENCE TABLE PAGE 7



Bevel planetary helical gearboxes

BPH.16

	EX	n ₁ = 3000 min ⁻¹			n ₁ = 1500 min ⁻¹			n ₁ = 1000 min ⁻¹			10000 HOURS LIFE	
		i _{eff}	n ₂ [min ⁻¹]	P _{N1} [kW]	T _{N2} [Nm]	n ₂ [min ⁻¹]	P _{N1} [kW]	T _{N2} [Nm]	n ₂ [min ⁻¹]	P _{N1} [kW]	T _{N2} [Nm]	T _{2ISO} [Nm]
BPH316	35.67	84	17.0	1890	42	10.5	2330	28	7.9	2630	4600	18.5 (*)
	40.55	74	16.6	2100	37	10.2	2590	25	7.7	2920	5100	
	42.10	71	16.5	2170	36	10.2	2670	24	7.6	3010	5500	
	47.86	63	15.1	2250	31	9.3	2770	21	7.0	3130	5800	
	57.61	52	13.1	2350	26	8.0	2890	17.4	6.0	3260	5000	
	65.67	46	11.9	2440	23	7.3	3010	15.2	5.5	3400	5000	
	70.80	42	11.3	2500	21	7.0	3080	14.1	5.2	3470	5000	
	83.2	36	10.2	2660	18.0	6.3	3270	12.0	4.7	3700	5800	
	88.1	34	9.7	2670	17.0	6.0	3280	11.4	4.5	3710	5000	
	100.1	30	8.9	2770	15.0	5.4	3410	10.0	4.1	3850	5000	
	114.1	26.3	8.1	2880	13.1	5.0	3550	8.8	3.7	4010	5000	
	123.1	24.4	7.7	2950	12.2	4.7	3630	8.1	3.6	4100	5000	
BPH416	130.2	23.0	6.94	2810	11.5	4.27	3460	7.7	3.12	3790	4600	14
	148.0	20.3	6.76	3110	10.1	4.16	3830	6.8	3.05	4220	5100	
	153.7	19.5	6.72	3210	9.8	4.14	3960	6.5	3.12	4470	5500	
	174.7	17.2	6.15	3340	8.6	3.78	4110	5.7	2.84	4640	5800	
	198.6	15.1	5.62	3470	7.6	3.45	4270	5.0	2.60	4820	5800	
	226.4	13.3	5.13	3610	6.6	3.15	4440	4.4	2.37	5020	5800	
	244.1	12.3	4.86	3690	6.1	2.99	4540	4.1	2.22	5060	5800	
	293.4	10.2	4.27	3900	5.1	2.63	4800	3.4	1.87	5120	5800	
	328.3	9.1	3.94	4030	4.6	2.43	4970	3.0	1.68	5160	5800	
	353.2	8.5	3.70	4070	4.2	2.20	4830	2.8	1.50	4950	5000	
	395.2	7.6	3.41	4200	3.8	1.97	4860	2.5	1.35	4990	5000	
	451.1	6.7	3.11	4370	3.3	1.74	4900	2.2	1.19	5030	5000	
	473.6	6.3	3.01	4440	3.2	1.67	4920	2.1	1.14	5040	5000	
	510.7	5.9	2.86	4540	2.9	1.55	4940	2.0	1.06	5070	5000	
	613.8	4.9	2.50	4780	2.4	1.31	5000	1.6	0.89	5120	5000	
	686.9	4.4	2.25	4820	2.2	1.18	5030	1.5	0.81	5190	5000	
	784.1	3.8	1.99	4860	1.9	1.04	5070	1.3	0.72	5290	5000	
	893.6	3.4	1.76	4900	1.7	0.92	5120	1.1	0.65	5400	5000	
963.5	3.1	1.64	4920	1.6	0.86	5140	1.0	0.60	5400	5000		
BPH516	560.8	5.3	2.61	4409	2.7	1.36	4864	1.8	0.93	4983	5500	11
	637.7	4.7	2.32	4442	2.4	1.21	4901	1.6	0.83	5075	5500	
	725.0	4.1	2.26	4932	2.1	1.18	5441	1.4	0.81	5615	5800	
	824.3	3.6	1.88	4650	1.8	0.98	5130	1.2	0.72	5643	5800	
	939.5	3.2	1.78	5015	1.6	0.92	5533	1.1	0.63	5643	5800	
	1013.0	3.0	1.65	5040	1.5	0.83	5342	1.0	0.56	5421	5800	
	1154.6	2.6	1.47	5115	1.3	0.74	5421	0.9	0.49	5421	5800	
	1244.9	2.4	1.37	5115	1.2	0.68	5421	0.8	0.46	5421	5800	
	1387.8	2.2	1.23	5115	1.1	0.61	5421	0.7	0.41	5412	5800	
	1581.9	1.9	1.00	4749	0.9	0.50	5034	0.6	0.33	5025	5500	
	1798.6	1.7	0.95	5115	0.8	0.47	5421	0.6	0.32	5421	5800	
	2012.8	1.5	0.85	5115	0.7	0.42	5421	0.5	0.28	5421	5800	
	2252.5	1.3	0.76	5115	0.7	0.38	5421	0.4	0.25	5421	5800	
	2600.7	1.2	0.65	5106	0.6	0.33	5412	0.4	0.22	5421	5800	
	2910.4	1.0	0.58	5106	0.5	0.29	5412	0.3	0.19	5412	5800	
	3126.0	1.0	0.54	5106	0.5	0.27	5412	0.3	0.18	5412	5800	
	3498.2	0.9	0.49	5106	0.4	0.24	5412	0.3	0.16	5421	5800	
	3914.8	0.8	0.43	5106	0.4	0.22	5412	0.3	0.14	5412	5800	
	4468.4	0.7	0.38	5115	0.3	0.19	5421	0.2	0.13	5430	5800	
	5100.2	0.6	0.33	5123	0.3	0.17	5430	0.2	0.11	5430	5800	
	6139.1	0.5	0.28	5214	0.2	0.14	5526	0.2	0.09	5509	5000	
	7544.5	0.4	0.23	5206	0.2	0.11	5518	0.1	0.08	5518	5000	

(*) PER POSIZIONI DI MONTAGGIO B6/V5/V6 P_T=15kW - FOR MOUNTING POSITION B6/V5/V6 P_T=15kW
 HIGHER RATIOS ARE AVAILABLE
 CONTACT OUR TECHNICAL SERVICE FOR POSSIBLE QUESTIONS



Bevel planetary helical gearboxes

BPH.18

EX	n ₁ = 3000 min ⁻¹			n ₁ = 1500 min ⁻¹			n ₁ = 1000 min ⁻¹			10000 HOURS LIFE		
	i _{eff}	n ₂ [min ⁻¹]	P _{N1} [kW]	T _{N2} [Nm]	n ₂ [min ⁻¹]	P _{N1} [kW]	T _{N2} [Nm]	n ₂ [min ⁻¹]	P _{N1} [kW]	T _{N2} [Nm]	T _{ISO} [Nm]	P _T [kW]
BPH318	35.7	84	19.0	2083	42	12.0	2624	28	9.1	3004	6900	22 (*)
	42.1	71	19.0	2458	36	12.0	3097	24	9.1	3546	7700	
	47.9	63	19.0	2795	31	12.0	3522	21	9.1	4031	7700	
	54.6	55	19.0	3186	27	12.0	4014	18	9.1	4595	7700	
	65.7	48	12.1	2319	24	7.6	2921	16	5.8	3344	6600	
	73.4	41	12.1	2737	20	7.6	3448	14	5.8	3947	7700	
	83.4	36	12.1	3112	18	7.6	3921	12	5.8	4488	7700	
	95.1	32	12.1	3547	16	7.6	4469	11	5.8	5115	7700	
	102.5	29	12.1	3824	15	7.6	4818	10	5.8	5515	7700	
BPH418	130.2	23.0	8.10	3207	11.5	5.10	4040	7.7	3.89	4625	6900	18
	148.0	20.3	8.10	3646	10.1	5.10	4594	6.8	3.89	5259	7700	
	153.7	19.5	8.10	3785	9.8	5.10	4769	6.5	3.89	5459	7700	
	174.7	17.2	8.10	4304	8.6	5.10	5422	5.7	3.89	6207	7700	
	198.6	15.1	7.43	4492	7.6	4.68	5659	5.0	3.57	6479	7700	
	226.4	13.3	6.81	4692	6.6	4.29	5912	4.4	3.27	6767	7700	
	244.1	12.3	6.48	4811	6.1	4.08	6062	4.1	3.11	6939	7700	
	293.4	10.2	5.73	5116	5.1	3.61	6445	3.4	2.75	7364	7700	
	328.3	9.1	5.32	5311	4.6	3.35	6692	3.0	2.47	7416	7700	
	374.8	8.0	4.87	5551	4.0	3.07	6993	2.7	2.19	7477	7700	
	394.6	7.6	4.35	5224	3.8	2.74	6581	2.5	2.08	7501	7700	
	425.4	7.1	4.14	5356	3.5	2.61	6749	2.4	1.94	7537	7700	
	511.4	5.9	3.66	5695	2.9	2.31	7175	2.0	1.63	7624	7700	
	572.3	5.2	3.40	5913	2.6	2.14	7450	1.7	1.48	7717	7700	
	653.2	4.6	3.11	6179	2.3	1.90	7548	1.5	1.31	7836	7700	
	744.5	4.0	2.87	6494	2.0	1.50	6782	1.3	1.02	6956	7700	
BPH518	560.8	5.3	3.46	5843	2.7	1.77	6005	1.8	1.21	6157	7700	15
	637.7	4.7	3.06	5888	2.4	1.57	6051	1.6	1.08	6263	7700	
	725.0	4.1	3.00	6552	2.1	1.54	6734	1.4	1.05	6931	7700	
	824.3	3.6	2.66	6611	1.8	1.36	6795	1.2	0.93	6931	7700	
	939.5	3.2	2.35	6663	1.6	1.21	6848	1.1	0.81	6931	7700	
	1013.0	3.0	2.19	6693	1.5	1.12	6878	1.0	0.76	6931	7700	
	1154.6	2.6	1.94	6744	1.3	0.99	6931	0.9	0.66	6924	7700	
	1244.9	2.4	1.80	6744	1.2	0.92	6931	0.8	0.61	6931	7700	
	1387.8	2.2	1.61	6737	1.1	0.83	6924	0.7	0.55	6924	7700	
	1581.9	1.9	1.33	6353	0.9	0.68	6529	0.6	0.46	6529	7700	
	1798.6	1.7	1.24	6744	0.8	0.64	6931	0.6	0.43	6931	7700	
	2012.8	1.5	1.11	6744	0.7	0.57	6931	0.5	0.38	6931	7700	
	2252.5	1.3	0.99	6744	0.7	0.51	6931	0.4	0.34	6931	7700	
	2609.7	1.1	0.86	6737	0.6	0.44	6924	0.4	0.29	6939	7700	
	2920.5	1.0	0.77	6737	0.5	0.39	6924	0.3	0.26	6924	7700	
	3136.8	1.0	0.71	6752	0.5	0.37	6939	0.3	0.24	6924	7700	
	3510.4	0.9	0.64	6737	0.4	0.33	6924	0.3	0.22	6924	7700	
	3928.4	0.8	0.57	6737	0.4	0.29	6924	0.3	0.19	6916	7700	
	4483.9	0.7	0.50	6737	0.3	0.26	6924	0.2	0.17	6947	7700	
	5117.9	0.6	0.44	6737	0.3	0.22	6924	0.2	0.15	6947	7700	

(*) PER POSIZIONI DI MONTAGGIO B6/V5/V6 P_T=18.5kW - FOR MOUNTING POSITION B6/V5/V6 P_T=18.5kW
 HIGHER RATIOS ARE AVAILABLE
 CONTACT OUR TECHNICAL SERVICE FOR POSSIBLE QUESTIONS



Bevel planetary helical gearboxes

BPH.20

	EX	n ₁ = 3000 min ⁻¹			n ₁ = 1500 min ⁻¹			n ₁ = 1000 min ⁻¹			10000 HOURS LIFE	
		i _{eff}	n ₂ [min ⁻¹]	P _{N1} [kW]	T _{N2} [Nm]	n ₂ [min ⁻¹]	P _{N1} [kW]	T _{N2} [Nm]	n ₂ [min ⁻¹]	P _{N1} [kW]	T _{N2} [Nm]	T _{ZISO} [Nm]
BPH320	30.10	100	28.2	2604	50	17.3	3206	33	13.0	3621	10100	22
	34.20	88	28.2	2959	44	17.3	3643	29	13.0	4115	11000	
	35.52	84	28.2	3074	42	17.3	3784	28	13.0	4274	10100	
	40.37	74	28.2	3493	37	17.3	4300	25	13.0	4857	10100	
	47.63	63	25.4	3717	31	15.6	4576	21	11.8	5167	10100	
	61.91	48	17.9	3402	24	11.0	4188	16	8.3	4730	10100	
	70.36	43	17.9	3866	21	11.0	4759	14	8.3	5375	10100	
	83.02	36	17.2	4391	18	10.6	5405	12	8.0	6105	10100	
	103.9	29	14.7	4697	14	9.1	5782	10	6.8	6530	9000	
BPH420	101.7	29.5	12.13	3753	14.7	7.46	4620	9.8	5.62	5218	10900	18.5
	115.6	26.0	12.13	4264	13.0	7.46	5250	8.7	5.62	5929	11000	
	120.1	25.0	12.13	4429	12.5	7.46	5453	8.3	5.62	6159	10100	
	136.4	22.0	12.13	5033	11.0	7.46	6197	7.3	5.62	6998	10100	
	155.9	19.2	10.10	4791	9.6	6.22	5898	6.4	4.68	6661	10100	
	177.2	16.9	10.10	5444	8.5	6.22	6703	5.6	4.68	7570	10100	
	205.2	14.6	8.11	5066	7.3	4.99	6237	4.9	3.76	7043	10100	
	213.1	14.1	8.11	5262	7.0	4.99	6478	4.7	3.76	7316	10100	
	242.2	12.4	8.11	5979	6.2	4.99	7361	4.1	3.76	8313	10100	
	280.1	10.7	7.33	6246	5.4	4.51	7690	3.6	3.40	8684	10100	
	308.9	9.7	6.41	6025	4.9	3.95	7418	3.2	2.97	8377	10100	
	371.5	8.1	5.15	5823	4.0	3.17	7169	2.7	2.39	8096	11000	
	422.1	7.1	5.15	6617	3.6	3.17	8146	2.4	2.39	9200	10100	
	488.3	6.1	4.65	6912	3.1	2.86	8510	2.0	2.16	9611	10100	
	576.2	5.2	4.48	7851	2.6	2.54	8900	1.7	1.74	9129	10100	
	650.1	4.6	3.48	6887	2.3	2.14	8479	1.5	1.61	9576	10100	
	738.7	4.1	3.48	7827	2.0	2.14	9636	1.4	1.57	10612	10100	
	871.7	3.4	3.30	8746	1.7	1.72	9134	1.1	1.18	9368	10100	
	1091.2	2.7	2.21	7327	1.4	1.15	7651	0.9	0.79	7848	9000	
BPH520	461.2	6.5	5.52	7669	3.3	3.15	9255	2.2	2.15	9488	10100	15
	544.2	5.5	3.88	6364	2.8	2.22	7680	1.8	1.52	7875	10100	
	599.0	5.0	4.32	7800	2.5	2.47	9413	1.7	1.66	9480	10100	
	706.8	4.2	3.04	6470	2.1	1.74	7808	1.4	1.19	8033	10100	
	818.6	3.7	3.19	7862	1.8	1.82	9488	1.2	1.21	9488	10100	
	918.0	3.3	2.37	6569	1.6	1.36	7928	1.1	0.95	8355	10100	
	966.0	3.1	2.26	6594	1.6	1.29	7958	1.0	0.91	8423	10100	
	1063.3	2.8	2.45	7862	1.4	1.40	9488	0.9	0.93	9488	10100	
	1229.9	2.4	2.12	7862	1.2	1.21	9488	0.8	0.81	9480	10100	
	1453.2	2.1	1.79	7862	1.0	1.03	9488	0.7	0.68	9480	10100	
	1680.9	1.8	1.55	7856	0.9	0.89	9480	0.6	0.59	9488	10100	
	1860.7	1.6	1.40	7862	0.8	0.80	9488	0.5	0.53	9480	10100	
	1983.5	1.5	1.22	7321	0.8	0.70	8835	0.5	0.49	9315	10100	
	2195.7	1.4	1.12	7440	0.7	0.64	8978	0.5	0.44	9315	10100	
	2543.1	1.2	1.03	7862	0.6	0.59	9488	0.4	0.39	9495	10100	
	3000.9	1.0	0.85	7713	0.5	0.49	9308	0.3	0.32	9308	10100	
	3245.2	0.9	0.80	7862	0.5	0.46	9488	0.3	0.31	9488	10100	
	3459.2	0.9	0.74	7725	0.4	0.42	9323	0.3	0.28	9323	10100	
	4001.2	0.7	0.64	7719	0.4	0.37	9315	0.2	0.24	9315	10100	
	5130.2	0.6	0.51	7868	0.3	0.29	9495	0.2	0.19	9480	10100	
	6053.7	0.5	0.42	7719	0.2	0.24	9315	0.2	0.16	9300	10100	

(*) PER POSIZIONI DI MONTAGGIO B6/V5/V6 P_T=20kW - FOR MOUNTING POSITION B6/V5/V6 P_T=20kW
 HIGHER RATIOS ARE AVAILABLE
 CONTACT OUR TECHNICAL SERVICE FOR POSSIBLE QUESTIONS



Bevel planetary helical gearboxes

BPH.23

EX	n ₁ = 3000 min ⁻¹			n ₁ = 1500 min ⁻¹			n ₁ = 1000 min ⁻¹			10000 HOURS LIFE		
	i _{eff}	n ₂ [min ⁻¹]	P _{N1} [kW]	T _{N2} [Nm]	n ₂ [min ⁻¹]	P _{N1} [kW]	T _{N2} [Nm]	n ₂ [min ⁻¹]	P _{N1} [kW]	T _{N2} [Nm]	T _{ISO} [Nm]	P _T [kW]
BPH323	30.66	98	39.5	3721	49	24.9	4688	33	19.0	5366	14100	37 (*)
	35.67	84	39.5	4328	42	24.9	5452	28	19.0	6241	16400	
	40.55	74	39.5	4920	37	24.9	6199	25	19.0	7096	16700	
	42.10	71	39.5	5108	36	24.9	6436	24	19.0	7367	15100	
	47.86	63	39.5	5808	31	24.4	7182	21	18.4	8111	15100	
	54.55	55	36.2	6067	27	22.3	7470	18	16.8	8436	15100	
	58.82	51	34.3	6206	26	21.1	7641	17	15.9	8629	15100	
	73.37	41	23.6	5326	20	14.9	6710	14	11.4	7681	15100	
	83.42	36	23.6	6056	18	14.9	7630	12	11.4	8734	15100	
	95.08	32	23.6	6902	16	14.9	8696	11	11.4	9954	15100	
102.5	29	23.3	7332	15	14.3	9026	10	10.8	10194	15100		
BPH423	120.6	24.9	17.64	6470	12.4	10.86	7965	8.3	8.18	8996	16400	25
	137.1	21.9	17.64	7356	10.9	10.86	9057	7.3	8.18	10228	16700	
	142.3	21.1	17.64	7637	10.5	10.86	9402	7.0	8.18	10618	15100	
	161.8	18.5	17.08	8407	9.3	10.51	10350	6.2	7.92	11689	15100	
	184.4	16.3	15.59	8743	8.1	9.59	10764	5.4	7.22	12157	15100	
	210.1	14.3	14.22	9093	7.1	8.76	11195	4.8	6.59	12643	15100	
	239.5	12.5	12.98	9457	6.3	7.99	11643	4.2	6.02	13149	15100	
	252.6	11.9	11.80	9071	5.9	7.27	11168	4.0	5.47	12613	15100	
	287.2	10.4	11.43	9986	5.2	7.04	12295	3.5	5.30	13885	15100	
	332.2	9.0	10.32	10432	4.5	6.35	12843	3.0	4.78	14505	15100	
	366.2	8.2	8.90	9915	4.1	5.61	12493	2.7	4.28	14301	15100	
	417.4	7.2	8.80	11172	3.6	5.42	13754	2.4	3.91	14901	15100	
	500.5	6.0	7.23	11004	3.0	4.55	13864	2.0	3.30	15071	15100	
	578.9	5.2	6.56	11551	2.6	4.13	14553	1.7	2.90	15303	15100	
	659.9	4.5	6.38	12817	2.3	3.72	14950	1.5	2.59	15609	15100	
	770.4	3.9	4.98	11663	1.9	3.13	14693	1.3	2.27	15979	15100	
	875.9	3.4	4.98	13260	1.7	2.87	15323	1.1	2.04	16292	15100	
	998.3	3.0	4.78	14512	1.5	2.57	15629	1.0	1.82	16618	15100	
1076.4	2.8	4.51	14761	1.4	2.35	15416	0.9	1.61	15811	15100		
BPH523	624.6	4.8	6.93	13042	2.4	4.00	15921	1.6	2.70	16082	15100	23
	710.2	4.2	6.15	13175	2.1	3.56	16082	1.4	2.37	16082	15100	
	811.3	3.7	5.39	13175	1.8	3.11	16082	1.2	2.08	16082	15100	
	922.4	3.3	4.74	13175	1.6	2.74	16082	1.1	1.83	16082	15100	
	987.5	3.0	4.43	13175	1.5	2.56	16082	1.0	1.71	16082	15100	
	1108.8	2.7	3.94	13182	1.4	2.28	16091	0.9	1.52	16082	15100	
	1260.7	2.4	3.47	13175	1.2	2.00	16082	0.8	1.34	16091	15100	
	1415.0	2.1	3.09	13175	1.1	1.79	16082	0.7	1.19	16082	15100	
	1608.8	1.9	2.72	13175	0.9	1.57	16082	0.6	1.05	16082	15100	
	1722.2	1.7	2.54	13182	0.9	1.47	16091	0.6	0.98	16082	15100	
	1993.1	1.5	2.19	13182	0.8	1.27	16091	0.5	0.84	16082	15100	
	2236.9	1.3	1.95	13182	0.7	1.13	16091	0.4	0.75	16082	15100	
	2543.3	1.2	1.72	13175	0.6	0.99	16082	0.4	0.66	16082	15100	
	2643.1	1.1	1.65	13182	0.6	0.96	16091	0.4	0.64	16082	15100	
	3057.2	1.0	1.43	13175	0.5	0.83	16082	0.3	0.55	16091	15100	
	3476.0	0.9	1.26	13182	0.4	0.73	16091	0.3	0.48	16082	15100	
	3961.8	0.8	1.10	13182	0.4	0.64	16091	0.3	0.43	16082	15100	
	4625.4	0.6	0.95	13182	0.3	0.55	16091	0.2	0.36	16082	15100	
	6083.0	0.5	0.72	13182	0.2	0.42	16091	0.2	0.28	16108	15100	

(*) PER POSIZIONI DI MONTAGGIO B6/V5/V6 PT=30kW - FOR MOUNTING POSITION B6/V5/V6 PT=30kW
 HIGHER RATIOS ARE AVAILABLE
 CONTACT OUR TECHNICAL SERVICE FOR POSSIBLE QUESTIONS



Bevel planetary helical gearboxes

BPH.25

	EX	n ₁ = 3000 min ⁻¹			n ₁ = 1500 min ⁻¹			n ₁ = 1000 min ⁻¹			10000 HOURS LIFE	
		i _{eff}	n ₂ [min ⁻¹]	P _{N1} [kW]	T _{N2} [Nm]	n ₂ [min ⁻¹]	P _{N1} [kW]	T _{N2} [Nm]	n ₂ [min ⁻¹]	P _{N1} [kW]	T _{N2} [Nm]	T _{2ISO} [Nm]
BPH325	34.20	88	62.1	6650	44	38.3	8200	29	28.8	9250	24200	40
	40.37	74	62.1	7850	37	38.4	9700	25	28.9	10950	22000	
	44.52	67	58.1	8100	34	35.7	9950	22	26.9	11250	22000	
	49.94	60	52.7	8250	30	32.4	10150	20	24.4	11450	22000	
	57.67	52	46.8	8450	26	28.8	10400	17.3	21.6	11700	22000	
	59.44	50	42.2	7850	25	26.0	9700	16.8	19.6	10950	24200	
	70.16	43	42.3	9300	21	26.0	11450	14.3	19.6	12900	22000	
	77.38	39	39.4	9550	19.4	24.2	11750	12.9	18.3	13300	22000	
	86.80	35	35.9	9750	17.3	22.0	11950	11.5	16.5	13500	22000	
	100.23	30	31.7	9950	15.0	19.5	12250	10.0	14.7	13850	22000	
	120.27	25	27.5	10350	12.5	16.9	12750	8.3	12.7	14400	20400	
BPH425	124.8	24.0	25.51	9690	12.0	15.69	11930	8.0	11.80	13470	24200	32
	147.3	20.4	25.49	11440	10.2	15.67	14080	6.8	11.80	15900	22000	
	167.5	17.9	23.30	11890	9.0	14.33	14640	6.0	10.78	16530	22000	
	190.9	15.7	21.25	12360	7.9	13.07	15220	5.2	9.84	17190	22000	
	205.9	14.6	20.17	12650	7.3	12.40	15570	4.9	9.33	17580	22000	
	247.5	12.1	17.71	13360	6.1	10.90	16450	4.0	8.20	18580	22000	
	276.9	10.8	16.37	13820	5.4	10.07	17020	3.6	7.58	19220	22000	
	291.2	10.3	15.81	14030	5.2	9.72	17270	3.4	7.32	19510	22000	
	331.9	9.0	14.42	14590	4.5	8.88	17970	3.0	6.68	20290	22000	
	357.8	8.4	13.69	14930	4.2	8.42	18380	2.8	6.33	20750	22000	
	394.6	7.6	12.77	15360	3.8	7.85	18910	2.5	5.91	21360	22000	
	430.1	7.0	12.02	15770	3.5	7.40	19420	2.3	5.55	21840	22000	
	481.3	6.2	11.12	16320	3.1	6.84	20090	2.1	4.99	21990	22000	
	530.8	5.7	10.37	16790	2.8	6.38	20670	1.9	4.55	22120	22000	
	595.4	5.0	9.40	17080	2.5	5.79	21030	1.7	4.12	22480	22000	
687.6	4.4	8.33	17480	2.2	5.13	21520	1.5	3.53	22230	22000		
784.8	3.8	7.60	18190	1.9	4.56	21850	1.3	3.12	22410	22000		
BPH525	611.5	4.9	9.00	16555	2.5	6.01	22581	1.6	4.01	22581	22000	30
	696.9	4.3	8.50	17820	2.2	5.27	22581	1.4	3.52	22581	22000	
	792.4	3.8	7.48	17915	1.9	4.64	22581	1.3	3.09	22581	22000	
	903.2	3.3	6.56	17915	1.7	4.07	22581	1.1	2.71	22581	22000	
	1010.8	3.0	5.86	17915	1.5	3.64	22581	1.0	2.42	22581	22000	
	1149.2	2.6	5.15	17915	1.3	3.20	22581	0.9	2.13	22581	22000	
	1262.0	2.4	4.69	17915	1.2	2.91	22581	0.8	1.94	22581	22000	
	1412.3	2.1	4.19	17915	1.1	2.60	22581	0.7	1.74	22581	22000	
	1557.6	1.9	4.72	22232	1.0	2.36	22581	0.6	1.57	22581	22000	
	1783.0	1.7	4.12	22232	0.8	2.06	22581	0.6	1.37	22581	22000	
	2010.5	1.5	3.66	22232	0.7	1.83	22581	0.5	1.22	22581	22000	
	2241.2	1.3	3.28	22232	0.7	1.64	22581	0.4	1.09	22581	22000	
	2508.1	1.2	2.93	22232	0.6	1.47	22581	0.4	0.98	22581	22000	
	2813.5	1.1	2.74	23344	0.5	1.31	22581	0.4	0.87	22581	22000	
	3130.2	1.0	2.35	22232	0.5	1.17	22581	0.3	0.78	22581	22000	
	3503.0	0.9	2.10	22232	0.4	1.05	22581	0.3	0.70	22581	22000	
	4210.4	0.7	1.75	22232	0.4	0.87	22581	0.2	0.58	22581	22000	
	4805.8	0.6	1.53	22232	0.3	0.76	22581	0.2	0.51	22581	22000	
5378.1	0.6	1.37	22232	0.3	0.68	22581	0.2	0.46	22581	22000		

(*) PER POSIZIONI DI MONTAGGIO B6/V5/V6 PT=37kW - FOR MOUNTING POSITION B6/V5/V6 PT=37kW
 HIGHER RATIOS ARE AVAILABLE
 CONTACT OUR TECHNICAL SERVICE FOR POSSIBLE QUESTIONS



Bevel planetary helical gearboxes

BPH.28

EX	n ₁ = 3000 min ⁻¹			n ₁ = 1500 min ⁻¹			n ₁ = 1000 min ⁻¹			10000 HOURS LIFE		
	i _{eff}	n ₂ [min ⁻¹]	P _{N1} [kW]	T _{N2} [Nm]	n ₂ [min ⁻¹]	P _{N1} [kW]	T _{N2} [Nm]	n ₂ [min ⁻¹]	P _{N1} [kW]	T _{N2} [Nm]	T _{2iso} [Nm]	P _T [kW]
BPH328	47.1	64	69.9	10106	32	43.0	12442	21	32.4	14051	35700	65 (*)
	58.2	52	58.7	10511	26	36.1	12941	17	27.2	14614	35600	
	67.0	45	52.2	10746	22	32.1	13230	15	24.2	14941	32000	
BPH428	144.9	20.7	32.12	14162	10.3	19.77	17436	6.9	14.89	19691	35700	45
	164.7	18.2	29.37	14716	9.1	18.08	18118	6.1	13.61	20461	35700	
	179.4	16.7	26.99	14730	8.4	16.61	18135	5.6	12.51	20481	35600	
	194.3	15.4	26.16	15465	7.7	16.10	19040	5.1	12.12	21503	35700	
	203.9	14.7	24.68	15306	7.4	15.19	18844	4.9	11.44	21281	35600	
	206.4	14.5	23.98	15059	7.3	14.76	18540	4.8	11.11	20938	32000	
	234.5	12.8	21.93	15648	6.4	13.50	19265	4.3	10.16	21757	32000	
	240.5	12.5	21.98	16085	6.2	13.53	19803	4.2	10.19	22365	35600	
	243.3	12.3	22.35	16543	6.2	13.76	20367	4.1	10.36	23001	35700	
	276.7	10.8	19.53	16445	5.4	12.02	20246	3.6	9.05	22864	32000	
	282.3	10.6	20.14	17299	5.3	12.40	21297	3.5	9.33	24052	35700	
	301.1	10.0	18.78	17206	5.0	11.56	21184	3.3	8.70	23924	35600	
	341.2	8.8	17.64	18309	4.4	10.86	22541	2.9	8.18	25457	35700	
	346.4	8.7	16.69	17591	4.3	10.27	21657	2.9	7.73	24458	32000	
	349.5	8.6	16.92	17992	4.3	10.42	22151	2.9	7.84	25016	35600	
	402.1	7.5	15.04	18394	3.7	9.26	22646	2.5	6.97	25575	32000	
422.3	7.1	14.82	19043	3.6	9.12	23445	2.4	6.87	26478	35600		
485.8	6.2	13.17	19469	3.1	8.11	23969	2.1	6.06	26892	32000		
BPH528	446.4 *	6.7	16.84	22619	3.4	9.63	25870	2.2	6.58	26520	35700	40
	507.3 *	5.9	14.94	22801	3.0	8.54	26078	2.0	5.85	26780	35700	
	576.4 *	5.2	13.25	22983	2.6	7.57	26286	1.7	5.24	27300	35700	
	598.6 *	5.0	12.79	23034	2.5	7.31	26345	1.7	5.08	27463	35700	
	627.9 *	4.8	10.40	19647	2.4	5.94	22471	1.6	4.06	23043	35700	
	680.2 *	4.4	11.35	23222	2.2	6.48	26559	1.5	4.56	28015	35700	
	713.5 *	4.2	9.23	19801	2.1	5.27	22646	1.4	3.63	23400	35700	
	740.9 *	4.0	8.91	19852	2.0	5.09	22705	1.3	3.52	23530	35700	
	802.6 *	3.7	9.78	23608	1.9	5.59	27001	1.2	3.91	28373	35700	
	851.5 *	3.5	9.30	23819	1.8	5.31	27242	1.2	3.69	28373	35700	
	869.6 *	3.4	9.14	23898	1.7	5.22	27333	1.1	3.61	28373	35700	
	954.3	3.1	8.44	24234	1.6	4.82	27716	1.0	3.29	28373	35700	
	1005.8	3.0	8.07	24427	1.5	4.61	27937	1.0	3.12	28373	35700	
	1068.0	2.8	7.67	24654	1.4	4.38	28197	0.9	2.94	28373	35700	
	1143.0	2.6	7.21	24802	1.3	4.12	28366	0.9	2.75	28373	35700	
	1181.2	2.5	5.84	20767	1.3	3.34	23751	0.8	2.37	25253	35700	
	1239.5	2.4	6.65	24802	1.2	3.80	28366	0.8	2.53	28373	35700	
	1348.7	2.2	6.11	24802	1.1	3.49	28366	0.7	2.33	28373	35700	
	1459.7	2.1	5.65	24802	1.0	3.23	28366	0.7	2.15	28373	35700	
	1521.8	2.0	4.71	21562	1.0	2.69	24661	0.7	1.81	24830	35700	
	1688.4	1.8	4.88	24802	0.9	2.79	28366	0.6	1.86	28373	35700	
	1806.7	1.7	4.07	22148	0.8	2.33	25331	0.6	1.65	26943	35700	
	1959.4	1.5	4.21	24802	0.8	2.40	28366	0.5	1.60	28373	35700	
	2040.6	1.5	4.04	24802	0.7	2.31	28366	0.5	1.54	28373	35700	
	2140.5	1.4	3.53	22722	0.7	2.02	25987	0.5	1.40	26975	35700	
	2367.7	1.3	3.48	24802	0.6	1.99	28366	0.4	1.33	28373	35700	
	2425.3	1.2	3.17	23159	0.6	1.81	26488	0.4	1.23	26975	35700	
	2554.5	1.2	3.23	24802	0.6	1.84	28366	0.4	1.23	28373	35700	
	2790.3	1.1	2.47	20721	0.5	1.41	23699	0.4	1.00	25188	32300	
	2964.6	1.0	2.78	24802	0.5	1.59	28366	0.3	1.06	28373	35700	
	3161.8	0.9	2.48	23586	0.5	1.42	26975	0.3	0.94	26975	35700	
	3582.2	0.8	2.30	24802	0.4	1.32	28366	0.3	0.88	28373	35700	
3669.4	0.8	2.14	23586	0.4	1.22	26975	0.3	0.81	26975	35700		
4221.6	0.7	1.74	22063	0.4	0.99	25233	0.2	0.66	25285	32300		
4433.8	0.7	1.77	23586	0.3	1.01	26975	0.2	0.67	26975	35700		
5101.1	0.6	1.44	22097	0.3	0.82	25272	0.2	0.55	25285	32300		

* Primo stadio EM1020/First stage EM1020

(*) PER POSIZIONI DI MONTAGGIO B6/V5/V6 PT=55kW - FOR MOUNTING POSITION B6/V5/V6 PT=55kW



6. STATO DI FORNITURA

I riduttori sono verniciati esternamente con fondo epossidico sintetico blu "RAL 5010", secondo il ciclo di verniciatura P0 (secondo ISO12944).

Le verniciature aggiuntive non devono superare lo spessore complessivo di 170 µm . Questa condizione è fondamentale per evitare la possibilità di formazione di cariche elettrostatiche.

La protezione è comunque idonea a resistere a normali ambienti industriali ed anche esterni.

Nel caso si abbia la necessità di ricevere riduttori verniciati di colore diverso, oppure non verniciati, con verniciatura a cura del cliente (o nel caso si prevedano particolari condizioni ambientali aggressive, che necessitano di verniciature speciali) lo stato di fornitura del riduttore dovrà essere stabilito all'atto del contratto.

Le parti esterne lavorate del riduttore come le estremità degli alberi, i piani di appoggio, i centraggi ecc. vengono protetti con olio (tectyl) antiossidante.

Tutti i riduttori, salvo diverse indicazioni contrattuali, **vengono forniti senza lubrificazione**; come indicato da una apposita etichetta adesiva allegata al riduttore stesso per evidenziarne lo stato.

6. DELIVERY STATE

Gearboxes are externally finished in "RAL 5010" blue synthetic epoxy primer applied in the P0 painting cycle (reference ISO 12944). The additional paint cycle thickness must not be greater than 170 µm. This finish is essential to avoid the build-up of electrostatic charges.

The standard paint finish is perfectly capable of withstanding all normal industrial environments, even outdoors.

If you require gearboxes to be finished in a different colour, or to be delivered unpainted for finishing at your own works (or if gearboxes have to operate in particularly harsh environmental conditions that require special paint finishes), you must specify this at the time of order.

Machined external parts like shaft ends, mating surfaces, alignment dowels etc. are coated in a protective antioxidant lubricant (tectyl).

Unless specified otherwise in the order, all gearboxes are delivered without oil. This is clearly stated on an adhesive label applied to the gearbox.





CT-6915-0610



*Pivosiplan s.r.l.u.
Via Dalla Francesca n°127 , 35040 Piacenza d'Adige (PD)
Tel. +39(0) 425594162 - Fax +39(0) 425585821
C.F./P.I. (VAT) IT01167530292
www.pivosiplan.com*