

COMOSO

CONTROLLED MOTION SOLUTIONS



Hydraulic Products

For

Machine Maintenance

www.comoso.com | 800.696.6165

HOSE & FITTINGS



Globalcore simplifies specifications by providing a unified family of constant working pressure hydraulic hoses in all sizes for the most commonly used pressure classes.

Any pressure. Any project. One solution. GlobalCore is the future that OEM's and end users around the world have been asking for: a unified family of robust hydraulic hoses.

Hose assemblies made while you wait at Comoso Stores

Hydraulic Hose & Tubing



- 3000psi
- 4000psi
- 5000psi
- 6000psi
- Rubber
- Thermoplastic
- Coil Hose
- Stainless Steel
- Carbon Steel
- Aluminum

Hose Fittings



- Field Attachable
- Parflex/Polyflex
- Stainless Steel
- Brass
- Crimp
- Adapters
- Swivels
- Barb
- CNG

Tube Fittings



- Flare
- Flareless
- Compression
- Instrumentation
- O-Ring Face
- Stainless Steel
- Clamps
- Tubing

Adapters



- Flange
- Swivels
- Conversion
- Pipe
- BSP
- JIS
- Komatsu

Hose Protection & Safety



- Sleeves
- Spiral Guards
- Metal Guards
- Fire Guards
- Temperature
- Abrasion
- Chemical
- Specialty
- Flow Fuses
- Strain Reliefs

Fabrication Equipment



- Crimpers
- Cut-Off
- Cleaning
- Marking
- Testing
- Tube Benders
- Tube Cutters
- Tube Fabrication
- Tube Flanging
- Flaring

HYDRAULIC FLUID



Hydraulic Fluid is stocked at Comoso Stores

Parker DuraClean

Unique additive chemistry designed to maximize oil life while providing optimum anti-wear protection

Inline Fluid Monitoring

Particle and RH detection with real time feedback

Fluid Analysis

Complete laboratory analysis.



Package Size	ISO 46 Part Number	Parker DuraClean
Jug	HYDRAULIC OIL-133 1 GALLON	942180 (2 1/2 gal)
Pail (5 gal)	HYDRAULIC OIL-133	941907
Drum (55 gal)	Call	9422125
Tote (275 gal)	Call	942126

SPILL CONTROL



Green Stuff is stocked at Comoso Stores

Part #200 - box of 4
1 bottle / 1lb ea
Absorbs 1 gallon
Equals 45 lbs of clay

Part #204 - Loose Fill
5 gal bucket/3.75 lbs
Absorbs 3 gallon
Equals 170 lbs of clay

Part #210 - 55 gal Drum
44lbs of Green Stuff
Absorbs 35 gallons
Equals 2000lbs of clay



Part #254 Spill Kit - Bag
Absorbs 4.5 gallons
Contains
1 - 0.25 cu.ft (2.5lbs)
2 - 12"x12" pillows
1 - 4' sock
1 each - Goggles, Nitrile Gloves,
Waste Bag, Whisk Broom & Dust



Part #211 - box of 16
4' sock (3" dia)
Absorbs 1 gal. each

Part #212 - box of 6
10' sock (3" dia)
Absorbs 2.5 gals. each

Part #213 - box of 3
20' sock (3" dia)
Absorbs 5 gals. each

Part #214 - box of 25
12"x12" pillow - Absorbs 4.5 gals. each



HYDRAULIC FILTRATION



Hydraulic Filters



Low Pressure	Return Line
Medium Pressure	Suction
High Pressure	Spin-On
Water Removal	Inline

System Management & Test



Filters Carts	Fluid Monitoring
Offline Systems	Diagnostic Tools
Oil Analysis	Sensors

Hydraulic Filtration



High Pressure	Portable
Medium Pressure	Cartridge
Low Pressure	Stainless Steel
Suction	Lube

Filter Carts and Replacement Elements are stocked at Comoso Stores

HYDRAULIC REPAIR



Repair Capabilities

- Cylinders
- Valves
- Pumps
- Motors
- Planetary's
- HPU repair
- Specialty services

Testing Capabilities

- 200HP circuit for testing
- 50HP/54GPM circuit for testing valves, cylinders, & hydraulic motors

Key Features

- Quality professional repairs
- Large capacity test stand
- Flexible repair options
- Stringent quality control procedures
- All major brands components & repairs
- Original manufactured parts (where applicable)
- Re-manufactured or after-market parts available
- 100% in-house performance testing capabilities
- Equipped with state-of-the-art contamination control
- Most repairs are back with industry leading 1 year warranty
- Tested by professional & knowledgeable fluid power experts
- Service & Repair most major brand manufacturer's components

Parker and Linde Hydrostatic Pump/ Motor Repair Specialists



SEALS & REPAIR KITS



Genuine Replacement Parts

- Parker
- Denison
- Commercial Hydraulics
- Linde
- Helac

Fluid Power Seals

- | | | |
|---|---|--|
|  | Wipers
Rod Seals
Piston Seals
Symmetrical Seals
Wear Ring | U-Cup
PolyPak
Backup Rings
Head Seals |
|---|---|--|

Packings

- | | | |
|---|---|---|
|  | Rod Seals
Piston Seals
T-Seals
V-Packing
Wipers | Wearing Rings
Scrapers
PTFE
Rope |
|---|---|---|

Assembly & Sizing Products

- | | | |
|---|----------------------|-------|
|  | Lubricants
Sizing | Tools |
|---|----------------------|-------|

O-Rings

- | | | |
|---|---|---------------------------------------|
|  | General Purpose
Low Temperature
Chemical Resis-
tant | Metric
AS568
Kalrez®
Spliced |
|---|---|---------------------------------------|

Composite & Bonded Seals

- | | | |
|---|------------------------------|-----------------------|
|  | Thread Seals
Washer Seals | Reinforced
Ceramic |
|---|------------------------------|-----------------------|

Rotary Sealing Products

- | | | |
|---|---|---|
|  | Oil Seals
Mechanical
Radial Shaft | High Speed
Spring Energized
Bearing Isolation |
|---|---|---|

HYDRAULIC COMPONENTS



Hydraulic Cylinders

- | | | |
|---|---|--|
|  | Most Popular
NFPA
Compact
Large Bore
Heavy Duty | Round Body
ISO
Electrohydraulic
Custom
Sensors |
|---|---|--|

Hydraulic Motors

- | | | |
|---|--|--|
|  | Gear
LSHT
Fixed
Variable
Radial Piston | High Speed
Bent Axis
Brakes
Clutches
Winches |
|---|--|--|

Hydraulic Rotary Actuators

- | | | |
|---|-----------------|-------------------------|
|  | Vane
Helical | Rack & Pinion
Custom |
|---|-----------------|-------------------------|

Gauges & Measurement

- | | | |
|---|---|--------------------------|
|  | Flow Meters
Gauges Isolators
Level Indicators | Thermometers
Pressure |
|---|---|--------------------------|

Heat Exchangers & Chillers

- | | | |
|---|--|-----------------------------------|
|  | Air Oil Coolers
Water Cooled
Water Oil | Chillers
Mobile
Accessories |
|---|--|-----------------------------------|

Accumulators

- | | | |
|---|--|---|
|  | Piston
Bladder
Diaphragm
Dampers
Gas Bottles | Isolators
Charge Kits
Safety Equip
Metal Bellows |
|---|--|---|

HYDRAULIC SYSTEMS

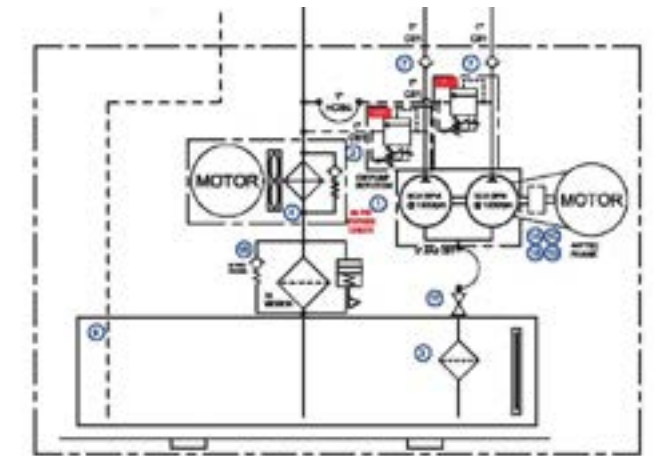
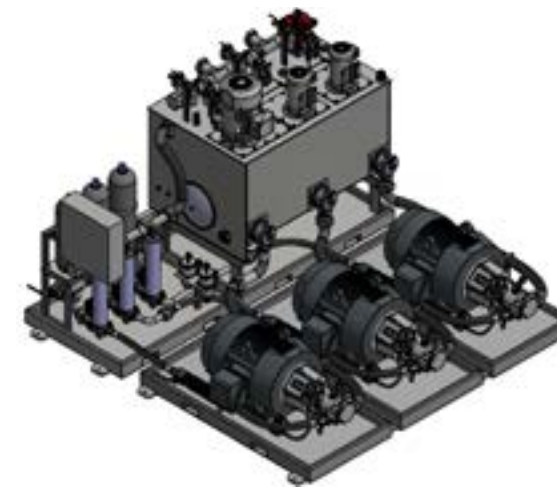

Fixed Displacement Pumps

- | | | |
|---|---|---|
|  | Most Popular
Gear
Multiple Gear
Vane
Piston | Bent Axis
Screw
Radial
Hybrid
Hydrostatic |
|---|---|---|

Variable Displacement Pumps

- | | |
|---|-----------------------------|
|  | Piston
Vane
Bent Axis |
|---|-----------------------------|

Reservoirs

- | | | |
|---|--|---|
|  | Steel
Aluminum
Stainless Steel
Endcovers
Trays/Stand | Filler Breathers
Diffusers
Strainers
Isolators |
|---|--|---|

Hydraulic Filters

- | | | |
|---|--|--|
|  | Low Pressure
Medium Pressure
High Pressure
Water Removal
Return Line | Suction
Spin-On
Inline
Duplex
Elements |
|---|--|--|

Directional Control Valves

- | | | |
|---|--|--|
|  | Most Popular
Solenoid
Proportional
Servo
Lever | Cam
Air Pilot
Hydraulic Pilot
Sandwich
Manifolds |
|---|--|--|

Cartridge Valves

- | | | |
|---|---|--|
|  | Solenoid
Proportional
Directional Control
Pressure Control | Flow Control
Load Controls
Manual Valves
Check
Shuttle |
|---|---|--|

Hydraulic System

- | | | |
|---|---|--|
|  | Relief
Flow Control
Pressure Control
Directional Control | Proportional
Sandwich
Ball
Check
Shuttle |
|---|---|--|

Electronics

- | | | |
|---|---|---|
|  | Motion Controllers
Display Units
PID Controls
Transducers & Switches | Pump Controls
Signal Converters
Sensors
Safety |
|---|---|---|

CAPABILITIES

Products

Actuators, Stages & Cylinders
Automation Components
Compressed Air Equipment
Controls
Drives & Motors
Electrical

Filtration
Gauges & Measurement
Hose, Tubing & Fittings
Hydraulics
Machine Safety
Mobile & Truck

Pneumatics
O-Rings & Seals
Sensors & Switches
Tools & Assembly
Vacuum
Valves

Services And Capabilities

24 Hour Mobile Hose Service
Seal Kitting Services
Hose Kitting Services

Cylinder Interchanges
Hydraulic Component Repair
Tube Bending and Fabrication

Rental Units/Equipment
Vendor Managed Inventory

Engineered Solutions

Control Systems & Enclosures
Standard Hydraulic Power
Units
Custom Hydraulic Power Units
Custom Hydraulic Manifolds

Pneumatic Systems & Assemblies
Seal Engineering
System Installation
System Design

Schematics
Custom Machine Guarding
Workstations & Workcells

Technologies

Automation
Compressed Air & Pneumatics
Controls/Control Panel
Electromechanical

Filtration
Hose, Tubing & Fittings
Hydraulics
Mobile Controls & Hydraulics

Machine Safety
Seals & Engineered Materials



People, Products & Performance

With Controlled Motion Solutions, you will find more than a distributor; we are a solutions provider. Comoso provides solutions to virtually everything that moves or requires control. As your fluid power specialist, we provide motion and control technology systems and engineering services for a wide variety of commercial, mobile and industrial markets.

Our Product Expertise:

- Actuators, Stages & Cylinders
- Automation Components
- Compressed Air Equipment
- Controls
- Drives & Motors
- Electrical
- Filtration
- Hose, Tubing & Fittings
- Hydraulics
- Machine Safety
- Pneumatics
- O-Rings & Seals
- Sensors & Switches
- Vacuum
- Valves
- Mobile Controls
- UL508a

LOCATIONS

**BURBANK/SUN VALLEY
SUN VALLEY**
9790 Glenoaks Blvd Suite 8
Sun Valley, CA 91352
818.238.9273 tel
818.238.9283 fax

**INLAND EMPIRE
CORONA**
950 El Sobrante Road
Corona, CA 92879
951.582.7007 tel
951.735.2106 fax

CHULA VISTA
1121 Bay Blvd Suite C
Chula Vista, CA 91911
619.424.9901 tel
619.424.9918 fax

**ARIZONA
TEMPE**
403 W. Broadway Road
Tempe, AZ 85282
602.437.8799 tel
602.437.8597 fax

**LOS ANGELES
SANTA FE SPRINGS**
11947 Florence Ave Suite 5
Santa Fe Springs, CA 90670
562.921.0713 tel
562.921.0793 fax

**CENTRAL CALIFORNIA
BAKERSFIELD**
4000 E. Brundage Lane
Bakersfield, CA 93307
661.324.2260 tel
661.324.9124 fax

**NORTHERN CALIFORNIA
OAKLAND**
1451 34th Street
Oakland, CA 94608
510.654.8950 tel
510.654.4108 fax

**NEVADA
LAS VEGAS**
7220 Dean Martin Dr.
Suite 400
Las Vegas, NV 89118
702.260.7765 tel
702.260.8198 fax

**ORANGE COUNTY
SANTA ANA**
Corporate Office
911 N. Poinsettia Street
Santa Ana, CA 92701
714.541.2244 tel
714.541.2266 fax

**SAN DIEGO COUNTY
ESCONDIDO**
2325 Auto Park Way
Escondido, CA 92029
760.781.3555 tel
760.781.3550 fax

SACRAMENTO
West Coast Fluid Power Div.
5370 S. Watt Ave Suite 300
Sacramento, CA 95826
800.532.8837 tel
800.370.0447 fax



HydraulicProdMaint Rev1.1