

aerospace
 climate control
 electromechanical
 filtration
 fluid & gas handling
 hydraulics
 pneumatics
 process control
 sealing & shielding



CAT 4660

Parflex® Thermoplastic & Fluoropolymer Products
 Hose, Tubing, Fittings & Accessories, Aug. 2014



ENGINEERING YOUR SUCCESS.

Extra care is taken in the preparation of this literature but Parker is not responsible for any inadvertent typographical errors or omissions. Information subject to change without notice. The information in this catalog is only accurate as of the date of publication. For a more current information base, please consult the Parflex® Division web site at www.parker.com/pfd.



FAILURE OR IMPROPER SELECTION OR IMPROPER USE OF THE PRODUCTS AND/OR SYSTEMS DESCRIBED HEREIN OR RELATED ITEMS CAN CAUSE DEATH, PERSONAL INJURY AND PROPERTY DAMAGE.

This document and other information from Parker Hannifin Corporation, its subsidiaries and authorized distributors provide product and/or system options for further investigation by users having technical expertise. It is important that you analyze all aspects of your application and review the information concerning the product or system in the current product catalog. Due to the variety of operating conditions and applications for these products or systems, the user, through its own analysis and testing, is solely responsible for making the final selection of the products and systems and assuring that all performance, safety and warning requirements of the application are met.

The products described herein, including without limitation, product features, specifications, designs, availability and pricing, are subject to change by Parker Hannifin Corporation and its subsidiaries at any time without notice.

Offer of Sale

The items described in this document are hereby offered for sale by Parker Hannifin Corporation, its subsidiaries or its authorized distributors. This offer and its acceptance are governed by the provisions stated in the "Offer of Sale".

©Copyright 2014 Parker Hannifin Corporation, All Rights Reserved

Welcome to The Parflex® Division



Our Charter

To be the global leader in engineered polymer-based products while providing system solutions for the conveyance and control of fluids.

As part of the Parker Fluid Connectors Group, the Parflex® Division is responsible for the design and manufacture of hoses and tubing to handle extreme applications. Products include thermoplastic and fluoropolymer hose and tubing, hose bundles, harnesses and accessories.

The Parflex® Division includes the Ravenna division headquarters in Ohio, and manufacturing facilities in:

- Manistowoc, WI
- Fort Worth, TX
- Houston, TX
- Randleman, NC
- Monterrey, Mexico



For detailed ordering information, please consult price list or contact Parflex® Division.

Parker Hannifin Corporation | Parflex® Division | Ravenna, Ohio | parker.com/pfd

www.comoso.com

Table of Contents

A Hose - Thermoplastic A-1 : A-67		Hose - Fluoropolymer A-68 : A-88	
Parflex Thermoplastic _____	A-4	Parflex Fluoropolymer _____	A-68
B Tubing Intro B-4 : B-47		Fluoropolymer Intro B-48 : B-53	
Polyethylene _____	B-10	PTFE _____	B-54
Nylon _____	B-18	FEP _____	B-82
Parprene _____	B-28	PFA _____	B-94
Polypropylene _____	B-32	PVDF _____	B-102
Polyurethane _____	B-34		
Clear Vinyl _____	B-44		
C Coiled Air Hose & Fittings C-1 : C-21			
Fast-Stor® Air Hose _____	C-6	NoMar™ Fast-Stor® Fittings _____	C-18
Fast-Stor® Fittings _____	C-10	Ultra-Lite Superbraid _____	C-20
NoMar™ Fast-Stor® Assemblies _____	C-14		
D Transportation (Fleet) D-1 : D-14			
Air Brake Tubing _____	D-4	DollyCoil™ _____	D-9
Diesel Fuel Tubing (PTFE-FL) _____	D-5	Slider Coil™ _____	D-10
Diesel Fuel Tubing (HTFL High Temperature) _____	D-6	Fifth Wheel Slider Coil _____	D-11
BRAKCOIL® _____	D-7	Custom Harnesses, Bundles & Tubing _____	D-12
Duo-Coil® _____	D-8	SCR Hose _____	D-13
E Fittings E-1 : E-128			
Hose Fittings _____	E-1		
F Tooling F-1 : F-23			
Crimpers _____	F-5	Sewer Hose Swagers & Accessories _____	F-13
Pumps _____	F-13	Cutting Tools _____	F-17
Dies _____	F-15	Hose Accessories _____	F-18
Conversion Kits _____	F-16		
G General Technical G-1 : G-72			
Hose Selection, Installation & Mtn. _____	G-4	Technical Data _____	G-43
Hose Assembly & Crimping _____	G-13	Material Compatibility Guide _____	G-45
Die Selection & Crimping Chart _____	G-42		
Safety Guide _____	G-61		
Offer of Sale _____	G-66		
Part Number Index _____	i		
Keyword Index _____	v		

For detailed ordering information, please consult price list or contact Parflex® Division.



Partner with Parflex®

We customize our extreme hose and tubing solutions every day to meet your needs.



Parker Parflex offers an extensive selection of high-quality thermoplastic and fluoropolymer hose and tubing, fittings and accessory solutions.

We specialize in designing products to meet specific needs for increased profitability and efficiency. We customize our products every day to meet your needs.

The Parflex® Advantage

One stop shopping for high value conveyance solutions.

Thermoplastic and Fluoropolymer Hose, Tubing, Fittings and Accessories for extreme applications.

Hose

When compared to wire reinforced rubber hose or even metal tubing, thermoplastic hose offers a significant added value. Thermoplastic provides extreme chemical compatibility, noise-level reduction and ultraviolet and corrosion resistance, while fiber reinforcement retains flexibility — even at low temperatures. In addition, Parflex has long-length capabilities resulting in less scrap being generated during assembly...fewer connections, results in fewer potential leak points.

For fluoropolymer hose, Parflex has expanded its PTFE Hose line to include the PAGE product line, manufactured in Fort Worth, TX. PAGE products are comprised of fluoropolymer hoses with specialty braid and construction options. These hoses are designed to handle high temperatures in chemical and corrosive environments for the pharmaceutical and food and beverage markets. Specialty products like PAGE-flex SBF™ (a hose with 1/2 the minimum bend radius of a conventional smooth bore hose) and EPDM rubber covered hoses are now available. We also design a full range of Parflex and PAGE hose fittings.

And that's just the beginning...

Tubing

Parflex has also expanded the tubing line to include PTFE, FEP, PFA and PVDF tubing. All are available in a smoothbore design and others are available in beading, heat shrinkable tubing and convoluted tubing. This tubing operates in high temperatures (up to 500°F/260°C) and in cryogenic applications with temperatures as low as -100°F/-75°C. Extrusions are resistant to UV radiation and moisture and offer the lowest coefficient of friction of any material available.

Additionally, ALL Parflex tubing products are made from resins and colors that are certified to be free of mercury, heavy metals and other materials that are restricted in accordance with the RoHS directive.

Unique Preforming Capabilities

Parflex preforming combines the precision of steel tubing with the flexibility of a hose. Preformed products profile complex shapes and long lengths, offering a working

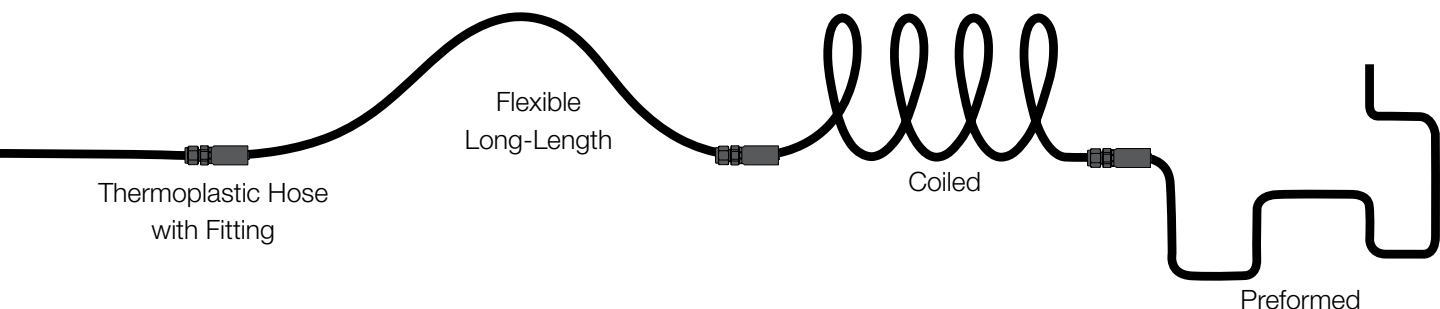

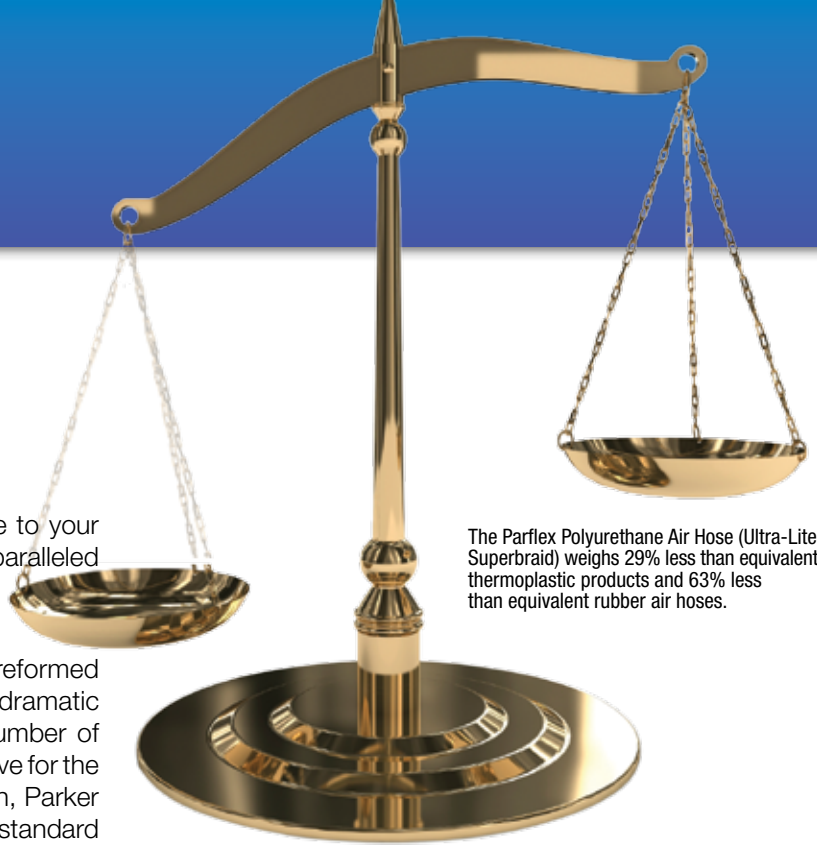

rigidity that ensures that the hose stays true to your lines and a superior flexibility to allow for unparalleled alignment compensation.

The Parflex Polyurethane Air Hose (Ultra-Lite Superbraided) weighs 29% less than equivalent thermoplastic products and 63% less than equivalent rubber air hoses.

In addition to installation ease, Parker preformed products increase productivity thanks to dramatic reductions in weight, leak paths and the number of components. They also are highly cost effective for the manufacturer. With excellent shape retention, Parker products can be easily coiled and packed in standard boxes, saving on shipping costs and inventory space.

Extremely Lightweight

Compared to rubber equivalents, Parflex products are lighter in weight due to their fiber reinforcements. In fact, a Parflex hose can weigh more than 70% less than a comparable rubber hose assembly. As a result of this greater strength-to-weight ratio, thermoplastics are easier to work with. Operator handling becomes less fatiguing and it is quicker and easier to route hoses onto equipment.

Thermoplastic vs. Rubber Hose Weight*

Size	Typical 100R7 Hose (Thermoplastic)	Typical 100R1 Hose (Rubber)
-4	0.052	0.170
-6	0.096	0.250
-8	0.148	0.300
-12	0.188	0.460
-16	0.269	0.660

*Weight: pounds/foot

Economical Small Bore

Prior to thermoplastics, system designers had to use hoses that were oversized for certain applications. More economical, small-bore rubber hose was simply not available in sizes smaller than 1/4" for applications with flows less than 3 gallons per minute. The use of oversized hoses resulted in substantial waste in systems; costing more, reducing response times and increasing installation times.

Thermoplastic vs. Rubber Hose O.D.*

Size	Typical 100R7 Hose (Thermoplastic)	Typical 100R1 Hose (Rubber)
-4	0.47	0.53
-6	0.63	0.69
-8	0.81	0.81
-12	1.08	1.09
-16	1.32	1.41

*Outside Diameter: inches

Today, system designers have a wealth of options to the 1/4" rubber hose. In fact, thermoplastic hose manufacturers have established full lines of hose for every application. With sizes that include 1/4", 3/16", 1/8", and 3/32", Parflex compact designs allow tighter bend radius characteristics, work well in smaller enveloped areas and give excellent fluid compatibility and higher abrasion resistance.

For detailed ordering information, please consult price list or contact Parflex® Division.

Parker Hannifin Corporation | Parflex® Division | Ravenna, Ohio | parker.com/pfd

www.comoso.com



Superior Abrasion and Fatigue Resistant

Thermoplastic products are known for having superior abrasion resistance over their rubber equivalents. Providing significantly longer wear, they offer as much as 100 to 30,000 times the abrasion resistance. Fiber braided thermoplastic hose also maintains better fatigue resistance than a wire-reinforced hose.

Parflex offers a choice of wire or fiber braid reinforced hose products. All hoses are specially designed to withstand abrasion and the abuse of constant flexing, assuring a longer service life without breaking or weakening. This makes them ideal for over-the-sheave applications and boom trucks, as well as an excellent option for abrasive environments like construction, forestry, mining and refuse.

Bonded Hose

Bonded assemblies help prevent hose-to-hose abrasion at high stress levels. By bonding 2 to 10 varying-sized hoses (maximum 10" O.D.) together, bonded assemblies keep hoses from rubbing

against each other or tangling. They are particularly beneficial for long runs, such as cable tracks. Parflex hose bonding keeps hoses straight for easier and more stable routing while improving quality by maintaining continuous hoses from end to end.

Convenient Harness and Bundle Integration

Similar to bonding, Parflex harnesses and bundles ensure quick assembly, eliminate waste and improve throughput. Custom engineered to meet the exact requirements of each manufacturer, Parflex harnesses reduce labor by supplying a pre-designed bundle of tubes to fit a customer's specific application. With all the connections secured together, the preformed harness decreases overall installation time, waste and human error, while improving part consistency for a neater and cleaner design. Companies can then re-allocate excess resources to bottleneck areas – increasing their overall throughput.





Cleanliness and Safety

Parflex products are designed with safety and cleanliness in mind. The erosion resistant core maintains long-term system cleanliness with mandrel free construction to ensure zero lubricant contamination. And with fiber reinforced Parflex thermoplastic hose, there's little to no contamination due to cutting because they do not require a hose saw.

While cleanliness is inherent in thermoplastic core tubes, some Parflex hoses also maintain non-conductivity, keeping the operator safe from electric shock. Most hoses feature a UV and ozone resistant cover, which resists cracking and UV damage, thus extending the service life of the hose.

Parflex has developed specific products that focus on safety. The 944B/955B high pressure PTFE hoses handle pressures up to 5,500 psi and are available with fire sleeves to facilitate safer operator handling.

For detailed ordering information, please consult price list or contact Parflex® Division.

Parker Hannifin Corporation | Parflex® Division | Ravenna, Ohio | parker.com/pfd

www.comoso.com





Environmental Concerns

In addition to being innovative and safe, Parflex is committed to being environmentally conscious as a company and global manufacturer and continues to develop environmental solutions for emerging markets such as compressed natural gas (CNG), oil and gas and wind power.

Within the CNG market, Parflex has designed a special CNG hose and bonded assemblies for use with CNG dispensers, transfer applications and transportation refill trailers. New fluoropolymer hoses have also been designed to target the oil and gas market. Finally, Parflex engineers have assembled comprehensive hydraulic and lubrication systems for the wind power sector. These systems include preformed, twinline, HLB lubrication hoses and hose bundles.

Existing markets will continue to change and new markets will emerge. And as they do, Parflex Engineers will be there to help you develop solutions for the new challenges and obstacles that arise. Parflex offers complete engineering support, including custom design solutions, on-site prototyping, pre-production fit-up and print creation.



Environmental Sustainability

Parflex is committed to managing our business, products and manufacturing activities in an environmentally conscious and sustainable method.

Parflex manufacturing locations are either ISO 14001 certified or ISO 14001 ready. The ISO 14001 Environmental Management System (EMS), developed by the International Standards Organization (ISO), provides a framework for companies to minimize the environmental impact of their operations, ensure compliance with applicable laws and regulations and to ensure continual improvement.

Utilizing the ISO 14001 system, Parflex has made significant progress towards reducing its carbon foot print through; reduced energy consumption, increased recycling activities and the reduction of raw material consumption through innovative product design, material selection and manufacturing technologies.

Parflex ensures consistent quality and faster implementation
– all to save you time and money.



For detailed ordering information, please consult price list or contact Parflex® Division.

Parker Hannifin Corporation | Parflex® Division | Ravenna, Ohio | parker.com/pfd



How to Use This Catalog

Table of Contents

For quick, easy listing of topics covered by section, reference the Table of Contents on pg. 1.

Information by Part Number

See the Part Number Index in Section G pg. i

Information by Type of Part

See the Key Word Index in Section G pg. v or check the Section Table of Contents/Visual Index found on the first page of each section in the catalog.

Information by Fitting End Configuration













See Standard Fitting Configurations by Connection and End Code in Section E, pg. 4. This list identifies the cataloged fittings by a description of the end configuration and the fitting end code.

The Parker Part Numbering System

The part numbering system for hose, fittings and tubing is explained on pgs. 12 & 13. Specific nomenclature sheets are located in the Hose Section on pgs. A-18 : A-21. In the Tubing Section, part number information is included on each product page.

International Symbols

An explanation of the symbols and their meaning used in the product tables can be found below.

Symbol	Meaning	Symbol	Meaning
#	Part Number		Minimum Burst Pressure
	Hose Inner Diameter (I.D.)		Weight
	Hose Outer Diameter (O.D.)		Vacuum Rating
	Working Pressure		Thread Size
	Minimum Bend Radius		Hex Size
	Crimp Die		Diameter
	Crimp Fitting		Field Attachable Fitting

ICON Identification Key



Agriculture



Automotive



Compressed Gas



Construction



Electrical



Fluid Handling



Food/Beverage



Forestry



Grounds/Bldg. Mtn.



Industrial



Industrial Pneumatic



Machine Tool



Marine



Material Handling



Medical



Military



Mining



Oilfield Service



Paint



Paving & Road Maintenance



Personnel Equipment



Pharmaceutical



RV & Bus



Semiconductor



Sewer Hose



Transportation



Utility Equipment



Waste Refuse

For detailed ordering information, please consult price list or contact Parflex® Division.

Parker Hannifin Corporation | Parflex® Division | Ravenna, Ohio | parker.com/pfd

www.comoso.com



Selecting the Right Hose

Choosing Your Hose

Before selecting hoses from Catalog 4660, it will be easier if you familiarize yourself with the basics of thermoplastic and fluoropolymer hoses. If you review the symbols on pg. 8 and the "How to Build A Hose Assembly" on pages 12 & 13 you will have a foundation for selecting your hose. Also, the Parflex Hose Selections Charts (located in Section A) will help pinpoint the hose you require. It will help you identify individual hoses by:

- Brief general description
- Specific size with corresponding working pressure
- Industry specification (ie. SAE)
- Core tube material
- Reinforcement/type of construction
- Cover material
- Specific page number where further detailed product information can be found

For fittings, refer to the visual indexes in Section E.

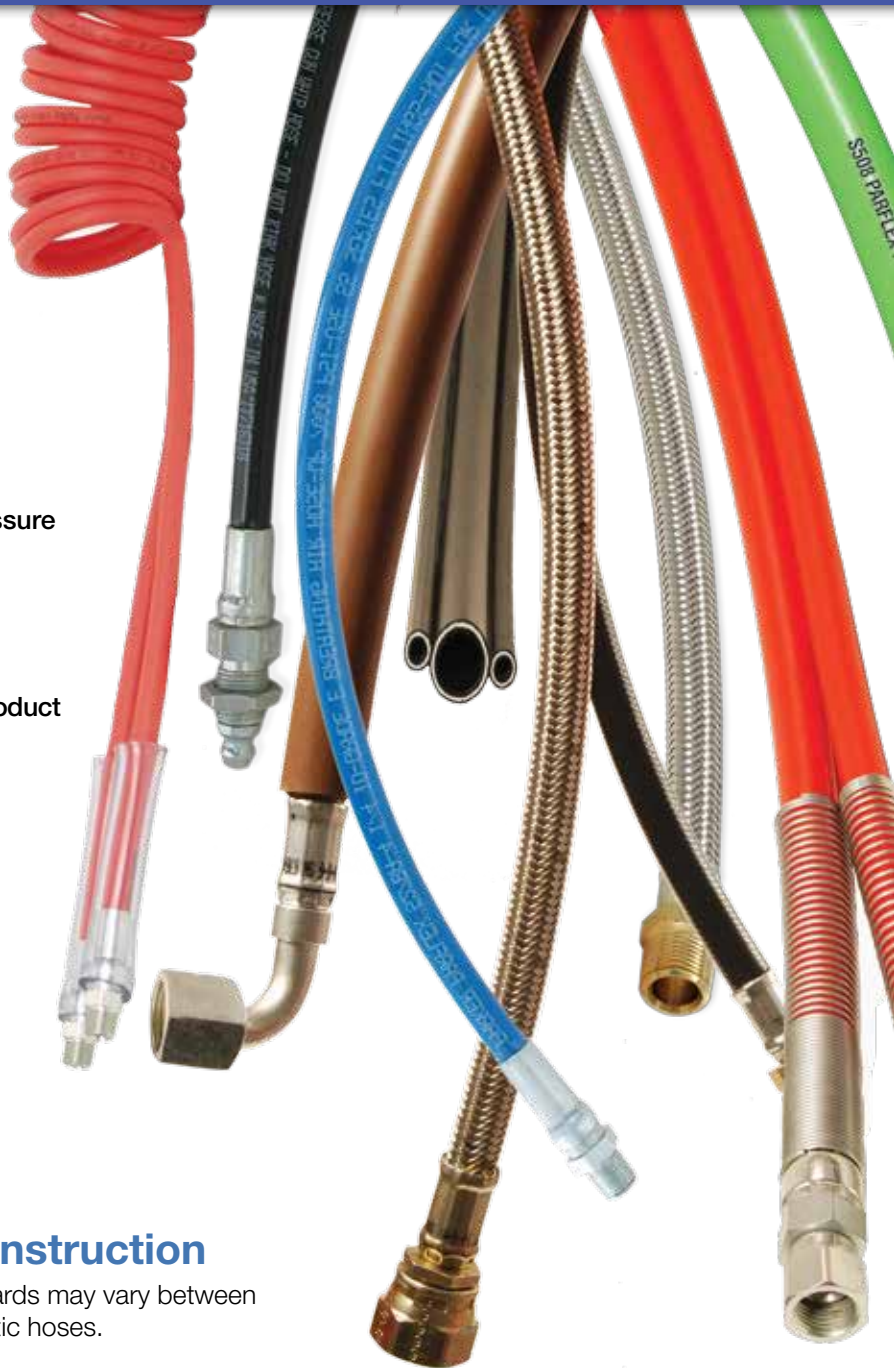

General Construction

Construction standards may vary between specific thermoplastic hoses.

Parflex bonds hose layers to provide maximum kink resistance and flexibility through a wide range of applications. Specific braid materials, wire reinforcements, spiral reinforcements and distinguishing features are clearly called out with each hose product. Perforated and non-perforated hoses are available based on application.

WITH NOTED EXCEPTIONS, Parflex hoses are engineered and manufactured to a 4:1 burst pressure to working pressure ratio that follows SAE design standards. Never operate a hose beyond its published working pressure. [Working Pressure x 4 = Minimum Burst]

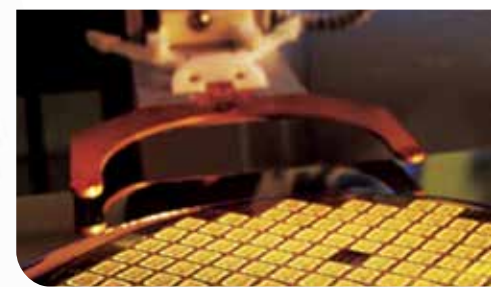
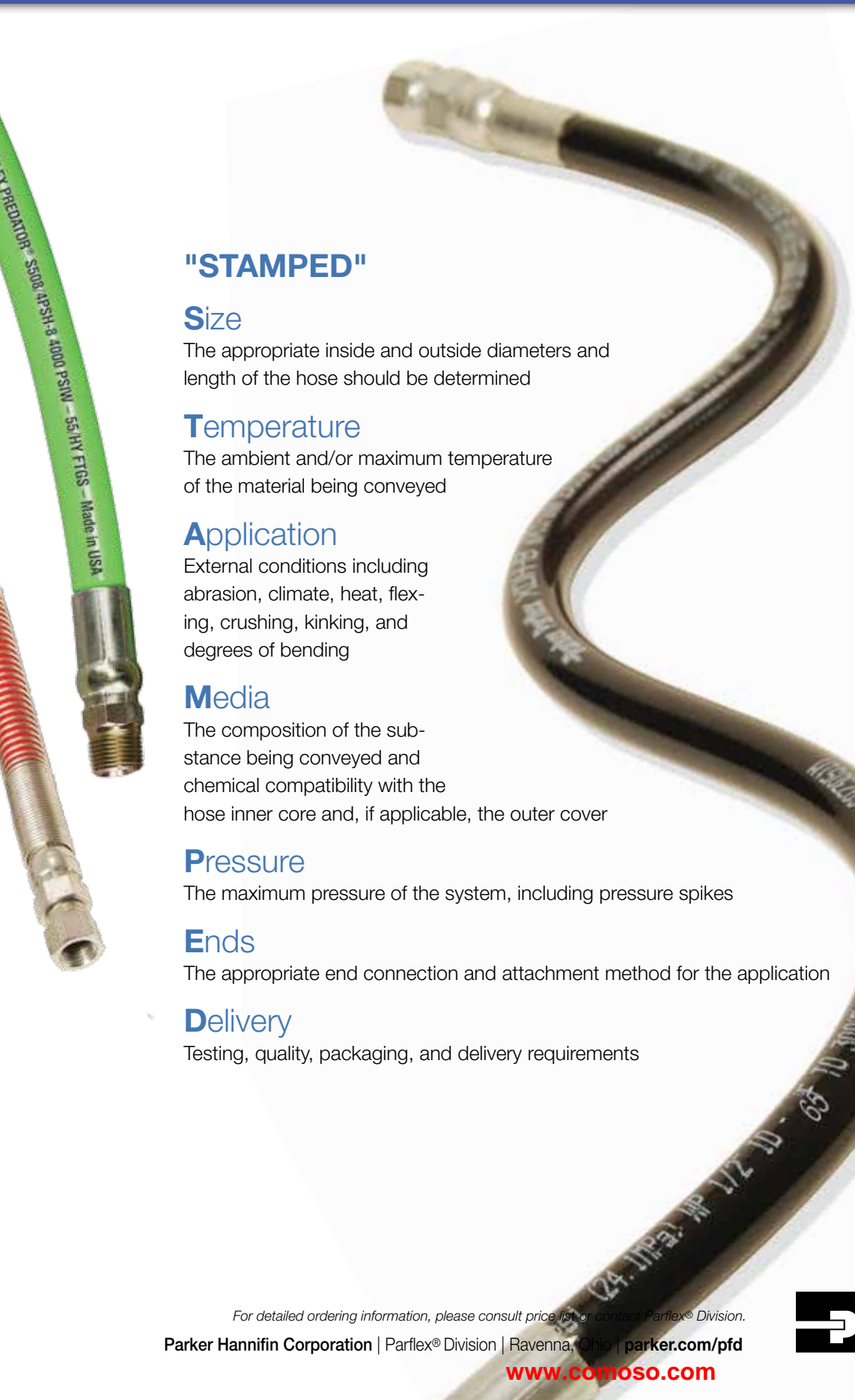

"STAMPED"

Size

The appropriate inside and outside diameters and length of the hose should be determined

Temperature

The ambient and/or maximum temperature of the material being conveyed

Application

External conditions including abrasion, climate, heat, flexing, crushing, kinking, and degrees of bending

Media

The composition of the substance being conveyed and chemical compatibility with the hose inner core and, if applicable, the outer cover

Pressure

The maximum pressure of the system, including pressure spikes

Ends

The appropriate end connection and attachment method for the application

Delivery

Testing, quality, packaging, and delivery requirements

For detailed ordering information, please consult price list or contact Parflex® Division.

Parker Hannifin Corporation | Parflex® Division | Ravenna, Ohio | parker.com/pfd

www.comoso.com



Hose, Fittings & Tubing Part Numbers

To make ordering of Parflex products easier, a part number description section has been added for hose, tubing and fitting products. For additional nomenclature information, refer to the following pages:

- Hose - Section Apgs. A-18 : A-21
- Tubing - Section BSee specific product page - Fluoropolymer pgs. B-52 : B-53
- Fittings - Section Epgs. E-2

Hose Part Numbers

Parflex has expanded the Hose section to include the PAGE Fluoropolymer product line. The PAGE product line is comprised of fluoropolymer hoses with specialty braid and construction options.

<p>Thermoplastic & Fluoropolymer</p> <p>Example: 520N – 8</p> <p>520N – 8 – Hose type (General Hydraulic Hose) 520N – 8 – Hose inside diameter dash size (1/2")</p>	<p>Parflex PAGE Fluoropolymer</p> <p>Example: 16-SCW</p> <p>16-SCW – Hose inside diameter dash size (1") 16-SCW – Hose type (Seamless Convuluted with Stainless Steel Braid)</p>
--	---

Hose Assembly Part Numbers

Example: F540N0639080808C-30"

This assembly example reflects a 1/2" I.D., 540N hose with a female JIC 37° swivel straight fitting on the first end and a female JIC 37° - swivel - 90° elbow fitting on the other. The fittings are stainless steel and crimped (permanently attached) onto the hose. The overall length is 30".

<p>1. Prefix</p> <p>F540N0639080808C-30"</p> <p>F = Crimp R = Field Attachable A = 54 Series Factory</p>	<p>3. Fitting 1st End</p> <p>F540N0639080808C-30"</p> <p>SAE 1/2" female JIC 37° swivel straight fitting</p>	<p>5. Size 1st End</p> <p>F540N0639080808C-30"</p> <p>1/2"</p>	<p>7. Hose End Dash Size</p> <p>F540N0639080808C-30"</p> <p>1/2"</p>
<p>2. Hose type</p> <p>F540N0639080808C-30"</p> <p>General Hydraulic Hose</p>	<p>4. Fitting 2nd End</p> <p>F540N0639080808C-30"</p> <p>SAE 1/2" 90° female JIC 37° swivel elbow fitting</p>	<p>6. Size 2nd End</p> <p>F540N0639080808C-30"</p> <p>1/2"</p>	<p>8. Fitting Material</p> <p>F540N0639080808C-30"</p> <p>- Blank = Steel (unless noted) - C = Stainless - B = Brass</p>
<p>9. Length</p> <p>F540N0639080808C-30"</p> <p>30" overall length</p>			

A complete nomenclature guide for Parflex PAGE hoses is located in Section A on pg. A-21.



For detailed ordering information, please consult price list or contact Parflex® Division.

Parker Hannifin Corporation | Parflex® Division | Ravenna, Ohio | parker.com/pfd

www.comoso.com

Hose Fittings Part Numbers

Parflex has expanded the Fitting Section to include the new 56 Series fittings, designed for global availability and with a smaller, compact O.D.

Example: 10356-8-6

This example describes a permanent crimp 1/2" Male JIC 37° Rigid hose end with a 3/8" hose end. This fitting is constructed of steel since the designated material is blank.

10356-8-6 – **Fitting Type** (1 = Permanent/Crimp)

10356-8-6 – **End Configuration Code**
(Male JIC 37° Rigid)

10356-8-6 – **Fitting Series** (Series 55)

10356-8-6 – **End Size** (1/2")

10356-8-6 – **Hose Size** (3/8")

Fitting Material

- Blank = Steel (unless otherwise noted)
- B = All Brass
- C = Stainless Steel
- S = All Carbon Steel – Used only with PTFE Fittings

Tubing Part Numbers

Parflex has expanded the Tubing Section to include the TexLoc Fluoropolymer product line. In addition to smooth bore tubing, TexLoc products include beading, convoluted tubing and heat shrinkable tubing. This tubing is supplied in natural and colors are available upon request. For a detailed fluoropolymer nomenclature guide, review Section B, pgs. B-52 : B-53.

Thermoplastic

Example: U-21-BLU-0250

U-21-BLU-0250 – **Polyurethane**

U-21-BLU-0250 – **Tube O.D.**

in sixteenths of an inch (1/8")

U-21-BLU-0250 – **Tube I.D.**

in sixteenths of an inch (1/16")

U-21-BLU-0250 – **Color** (Blue)

U-21-BLU-0250 – **Package quantity** (250')

Available colors

- | | |
|------------------|------------------------------|
| ● BLK = Black | ● ORG = Orange |
| ● BLU = Blue | ● RED = Red |
| ● GRY = Gray | ● YEL = Yellow |
| ● GRN = Green | (colors may vary by product) |
| ● None = Natural | |

Fluoropolymer

Example: 101-0250062-NT-0100

101-0250062-NT-0100 – **PTFE**

101-0250062-NT-0100 – **Tube O.D.**

inch displayed in decimals (1/4")

101-0250062-NT-0100 – **Wall Thickness**

inch displayed in decimals (.062")

101-0250062-NT-0100 – **Color** (Natural)

101-0250062-NT-0100 – **Bulk Tubing**

101-0250062-NT-0100 – **Package quantity** (100')

Available colors

- | | |
|---------------|--------------|
| ● N = Natural | ● 5 = Green |
| ● 0 = Black | ● 3 = Orange |
| ● 6 = Blue | ● 2 = Red |
| ● 1 = Brown | ● 4 = Yellow |
| ● 8 = Gray | ● 9 = White |

For detailed ordering information, please consult price list or contact Parflex® Division.

Parker Hannifin Corporation | Parflex® Division | Ravenna, Ohio | parker.com/pfd

www.comoso.com



Why Use Thermoplastic Tubing?



Benefits of Thermoplastic Tubing Materials and Applications*

Nylon	Strength Chemical Compatibility	Instrumentation Food & Beverage
Polyethylene	Food/Water Contact Cost	Potable Water Chemical Transfer
Polyurethane	Flexibility	Pneumatics
Polypropylene	Food Contact Chemical Transfer Chlorinated Water	Robotics Machine Tools Lubrication
Vinyl	Cost Flexibility Food Contact Clarity	Pest Control Lines Semiconductor Marine Applications Weld Spatter/Spark Environments

*Certain materials perform better in particular applications. Contact Customer Service for details.



For detailed ordering information, please consult price list or contact Parflex® Division.

Parker Hannifin Corporation | Parflex® Division | Ravenna, Ohio | parker.com/pfd

www.comoso.com

Why Use Fluoropolymer Tubing?



Benefits of Fluoropolymer Tubing Materials and Applications*

All	Self extinguishing Nonwetting FDA & USP Class VI compliant	Pharmaceutical Solar Panels Pulp & Paper
PTFE	Operates up to 500°F Lowest coefficient of friction	Food Processing Environmental Sampling
FEP	Operates up to 400°F Long, continuous lengths	Chemical Delivery
PFA	Operates up to 500°F Long, continuous lengths High purity resins available	Chromatography Paint Equipment Instrumentation
PVDF	Operates up to 265°F Food Contact Chemical Transfer Chlorinated Water	Heat Exchanger Ink Rollers Medical Devices

*Certain materials perform better in particular applications. Contact Customer Service for details.

For detailed ordering information, please consult price list or contact Parflex® Division.

Parker Hannifin Corporation | Parflex® Division | Ravenna, Ohio | parker.com/pfd

www.comoso.com



Mobile Hydraulics



Parflex Mobile Hydraulic products meet the needs of four primary market segments: aerial lift, agriculture, construction and material handling. Why are Parflex products so popular? Namely, cleanliness, high-impulse hybrid hoses, low volumetric expansion, lightweight and long-length manufacturing, as well as, ease of service and preformed capabilities.

Within the aerial lift market, Parflex products range from the eXtreme™ Duty hose to twin and multi-bonded hoses to preformed products and crimping. For the agriculture market,

Parflex products are used for oil return lines on tractors, polyethylene transfer tubes for sprayer application and grease lines on harvesters. In the construction market, Parflex products help save you money by replacing single-line rubber hoses with non-abrasive, lighter weight bonded thermoplastics on equipment. Finally, in material handling, Parflex products answer over-the-sheave and cold/refrigerated challenges.

Applications

- General Hydraulics
 - Off-Road Construction
 - Earth Moving Equipment
 - Lift Trucks
 - Material Handling
 - Construction Equipment
 - Refuse Haulers
 - Agricultural Equipment
- Lubrication lines
- Over-the-sheave applications
- Power steering
- Compressor discharge
- General hydraulics
- Hydraulic & pneumatic systems
- Commercial refrigeration
- Cold storage
- Testing labs
- Material handling
- Conveyor equipment
- Mower attachments
- Implement hydraulic power
- Diagnostics/Gaging
- PTO's
- Aerial Lift Hydraulic Tools
- Pilot Control Lines
- Turbo Drain Lines





Markets

- Material Handling Equipment
- Marine
- Agricultural Equipment
- Utility Equipment
- Sewer Cleaning Equipment
- Aerial Lift
- Construction Equipment
- Rough Terrain Equipment
- Refuse Haulers
- Mining



For detailed ordering information, please consult price list or contact Parflex® Division.

Parker Hannifin Corporation | Parflex® Division | Ravenna, Ohio | parker.com/pfd

www.comoso.com



Fluid Handling



Parflex Fluid Handling products are categorized by their thermoplastic and fluoropolymer (PTFE) makeup. Thermoplastic products service lubrication, carpet (power) cleaning, sewer cleaning, breathing air, media transfer, and refrigeration markets while Fluoropolymer (PTFE) products meet a wide array of needs as a result of PTFE's unique material benefits.

Fluoropolymer (PTFE) products – which include smooth bore & convoluted hose, as well as steel, stainless steel, and brass fittings – service automotive, oil & gas, power generation, packaging/chemical transfer, and pulp & paper markets and applications. All of these markets and applications greatly benefit from PTFE's chemical resistance, extreme temperature range, low friction, non-stick and flexibility. They also take advantage of PTFE's

unlimited shelf life, high purity and natural FDA-compliant and black static dissipative core tube.

The Parflex PAGE fluoropolymer hose line extends the PTFE hose selection even further with convoluted hose assemblies, PTFE encapsulated fittings and PTFE flare-thru fittings for the pharmaceutical and food and beverage market.

Applications

- Car care
- Semi-conductor (Pure air or gas transfer)
- Pharmaceutical dispensing
- Lubrication systems
 - Forklift
 - Machine tool
 - Heavy equipment
- Breathing air systems
- Chemical dispensing
- Sewer cleaning
- Alternative Fuels
- Potable water delivery
- Carpet (Power) cleaning
- Coolant lines
- Agricultural spraying
- Oil & Gas transfer (Petrochemical)
- Food and Beverage
- Chemical and Gas Transfer



For detailed ordering information, please consult price list or contact Parflex® Division.



Markets

- Industrial Equipment
- Utilities (CNG)
- Semiconductor
- Chemical
- Commercial Refrigeration
- Water Treatment
- Power Cleaning
- Power Generation
- Car Care
- Pharmaceutical
- Bio-Pharmaceutical
- Pulp & Paper
- Oil & Gas



For detailed ordering information, please consult price list or contact Parflex® Division.

Parker Hannifin Corporation | Parflex® Division | Ravenna, Ohio | parker.com/pfd

www.comoso.com



Industrial Pneumatics



Parflex Industrial Pneumatics provide high-quality air tool, robotic and coiled thermoplastic solutions. A diverse product line includes lightweight, non-marring, flexible hose and thermoplastic or fluoropolymer tubing.

Ideal for construction, carpentry, automotive and aerospace industries, Parflex air hose assemblies are a smart investment over rubber counterparts. Parflex hoses are lighter weight, feature a no-mar, easy-clean outer cover and can be coiled or uncoiled down to -40°F without memory effect. All of which helps to improve worker safety, reduce property damage, lessen equipment repair/replacement, and, most importantly, increase productivity.

Parflex additionally offers products specifically designed for robotic applications, such as low-pressure 83FR hose and HUFR tubing. Tubing and hose bundling products for general robotics reduce installation time and promote longer life. For coiled thermoplastic solutions, look no further than Parflex tough, abrasion and kink-resistant coiled hoses.

The Parflex coiled selection includes Fast-Stor® coils and Ultra-Lite Superbraid, designed for markets like transportation, manufacturing and robotics.



Applications

- Air tools
- Robotic welding
- End-of-arm tooling
- Metal working
- Automotive maintenance
- General robotics

Markets

- Robotics
- Packaging Machinery
- Machine Tool
- Construction
- Automotive Maintenance
- Medical Equipment
- Laboratory Equipment
- Furniture Manufacturing
- Aerospace



For detailed ordering information, please consult price list or contact Parflex® Division.

Parker Hannifin Corporation | Parflex® Division | Ravenna, Ohio | parker.com/pfd

www.comoso.com



Industrial Hydraulics



Parflex Industrial Hydraulics develops thermoplastic hose and fitting products – from fiber, wire and Aramid fiber reinforced products to steel, stainless steel, and brass fittings to equipment & accessories – for today's fastest growing markets.

Parflex provides the power generation market with hose, tubing and bundles for turbine control valves, fuel systems and steam monitoring and thermoplastic hose and bonded hose assemblies for car & truck wash applications. In addition, Parflex manufactures hose reels for service

garages, auto and truck dealers, construction service shops and farm equipment service centers.

Parflex also provides hydraulic product equipment, such as MiniKrimp™ machines, to rental yards and forklift service companies. Ideal for field repairs, the lightweight, economical MiniKrimp™ hand pump and air/hydraulic models can crimp a majority of Parker thermoplastic, rubber, hybrid and PTFE hoses up to 3/4" I.D.

Applications

- Injection molding
- Patient handling
- Car care
- Lubrication systems
- Molding and transfer lines for plastics
- Hydraulic or vacuum connections
- General hydraulic lines
- Metal cutting
- Metal forming
- Vertical machining centers
- Hand brakes
- Press brakes
- Bending machines
- Automotive maintenance
- Rescue tools



Markets

- Machine Tools
- Hydraulic Tools
- Power Generation
- Mining Equipment
- Patient Handling
- Car Care
- Automotive
- Rescue Tools
- Lubrication Systems
- Recreational Vehicles



For detailed ordering information, please consult price list or contact Parflex® Division.

Parker Hannifin Corporation | Parflex® Division | Ravenna, Ohio | parker.com/pfd

www.comoso.com



Transportation



Parflex Transportation products have been specifically designed to meet the needs of trucks, specialty trucks (such as military, fire and terminal), buses and RVs, engines, and trailers.

An extensive line of transportation products includes a selection of air brake tubing for standard distribution and large OEMs, air brake harnesses, coils, fuel tubing and 100% pressure-tested fleet tubing for use with diesel fuel.

Steering lines on transit buses run from the back engine all the way to the front steering gear, which can require up to 40 feet of stainless steel tubing. Parflex offers a more manageable solution:

the eXtreme™ Duty Hose. Parflex also supplies products for turbo supply/drain and other coolant lines, from smooth bore to convoluted, lightweight lubricant systems, and flexible metal hose.

Parflex metal hose assemblies are built, tested, cleaned and packaged to suit customer requirements. With zero permeation, excellent chemical resistance and a full vacuum rating, Parflex metal hose handles temperatures that simply aren't compatible with rubber or other thermoplastics!

Applications

- Fuel lines
- Power steering
- Coiled air brake
- Exhaust and AC lines
- Lubrication systems
- Mini hydraulics
- Compressor discharge
- Fast response
- Compressed natural gas
- Fuel transfer





Markets

- Class 8 Heavy Truck
- Standard Box Truck
- Diesel Truck
- Bus
- Refrigeration Truck
- Refuse Truck
- Fire Truck
- Trailers
- Street Sweepers
- Military Vehicles
- RV's



For detailed ordering information, please consult price list or contact Parflex® Division.

Parker Hannifin Corporation | Parflex® Division | Ravenna, Ohio | parker.com/pfd

www.comoso.com



Life Science



Parflex has extended the selection of medical tubing capabilities through the TexMed® side of the TexLoc® business unit in Fort Worth, TX. TexMed specializes in the extrusion of precision tolerances for custom tubing and custom profiles of TexFluor® PTFE, ePTFE, FEP, PFA, and ETFE. Coupled with the traditional line of thermoplastic tubing in Vinyl, Polypropylene and Nylon Pure Air tubing, Parflex has a tube for almost every medical application.

With an emphasis on partnering, Parflex Engineers work closely with our customer's engineers to create tubing products with increased performance. The newest development is a medical grade FEP Heat Shrink for catheter forming. Unlike typical FEP heat shrink, which often wrinkles, twist or grows up to 20% in length when shrinking, the new heat shrink has a uniform recovery and a maximum constrained elongation up to + 5%. And with a faster recovery time, medical grade FEP Heat Shrink is very responsive in reflow applications for catheter manufacturing.

Parker/TexMed Advantages include:

- Application and Material Engineering Support
- Precision tolerance tubing
- Ability to handle low volume start up projects
- Class 10,000 clean room
- Complete traceability on each lot of product
- Wide range of US Class VI compliant materials

In the value added service department, specialty operations such as laser marking, tube cutting, scoring, slitting, marking, flanging, flaring, tipping and other services are available.

Applications

- Catheter construction
- Sheathing
- Forming devices
- Introducers
- Dental equipment
- Endoscopic instruments
- Tracheotomy tubes
- Blood analyzer
- Lab instruments
- General robotics
- Air and gas transport
- Packaging





Markets

- Medical Device
- Medical Equipment
- Dental



For detailed ordering information, please consult price list or contact Parflex® Division.

Parker Hannifin Corporation | Parflex® Division | Ravenna, Ohio | parker.com/pfd

www.comoso.com



Food & Beverage



Parflex Hose and Tubing for the Food and Beverage market is comprised of FDA compliant thermoplastic tubing and fluoropolymer hose and tubing. Tubing is available in Polyethylene, Polypropylene, Vinyl and Fluoropolymers, consisting of PTFE, FEP, PFA & PVDF.

Parflex PAGE high temperature food processing hoses are available in several types and sizes. All of these hoses offer a seamless tube that resists the collection of bacteria, preserve taste and are very easy to clean. For added strength and durability, each hose has an added reinforcement that withstands internal pressures, a helical wire for full vacuum capabilities, and a high-grade weather and abrasion resistant cover for longevity.

All of the Parflex PAGE Food Transfer Hoses are compliant with FDA, 3A and USDA product standards. Additional compliance for specialty hoses includes PMPO (Grade A Pasteurized Milk Ordinance) and CFIA (Canadian Food Inspection Agency).

One of the more unique hoses, PAGE-flex® SBF™, offers a superior bend radius (1/2 the bend radius of conventional fluoropolymer braided hoses) coupled with superior kink and vacuum resistance.

Applications

- Transport of edible oils, syrup, milk and other food products
- Dispensing equipment
- Tank transfer of raw products
- In-plant transfer for processing



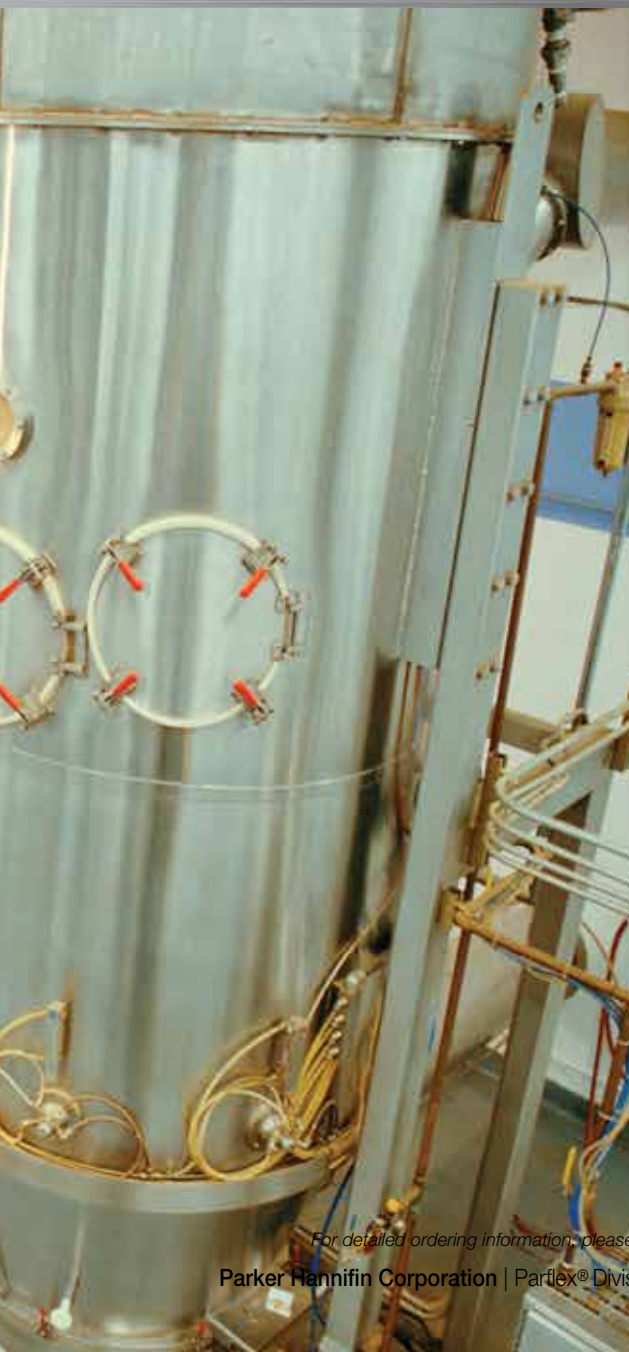

Markets

- Food
- Beverage

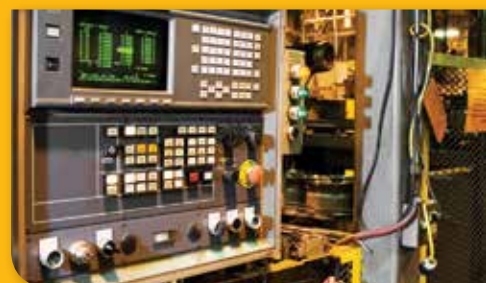

For detailed ordering information, please consult price list or contact Parflex® Division.

Parker Hannifin Corporation | Parflex® Division | Ravenna, Ohio | parker.com/pfd

www.comoso.com



Hose

Thermoplastic

Fluoropolymer



Table of Contents

Introduction

	Visual Index	A-4 : A-6
	Understanding Parflex Hose	A-7
	How to Read the Hose Section.....	A-8
	Thermoplastic Hose Selection - Construction/Specifications, psi.....	A-10
	Thermoplastic Hose Selection - Construction/Specifications, MPa.....	A-14
	Fluoropolymer Hose Selection - Construction/Specifications, psi	A-12
	Fluoropolymer Hose Selection - Construction/Specifications, MPa.....	A-16
	Nomenclature - Parflex Thermoplastic Hose Assembly.....	A-18
	Nomenclature - Parflex PTFE Hose Assembly.....	A-19
	Nomenclature - PAGE Industrial S30 & S40 Hose Assembly.....	A-20
	Nomenclature - "True-Bore" & Convolved Hose Assembly.....	A-21

Parflex Thermoplastic Hose

	510A Refrigerant	A-38
	510C General Hydraulic	A-39
	518C General Hydraulic	A-40
	518D General Hydraulic	A-41
	515H Compact	A-42
	520N General Hydraulic	A-43
	526BA Breathing Air Refill, 6000 psi	A-44
	527BA Breathing Air Refill, 7000 psi	A-45
	528N General Hydraulic, Non-Conductive.....	A-43
	53DM/538DM DuraMax™ Low Temperature/Non-Conductive	A-46
	540N General Hydraulic	A-47
	540P Specialty Water.....	A-48
	55LT Low Temperature	A-49
	560/560R General Hydraulic	A-34
	563 General Hydraulic.....	A-35
	56DH/568DH Diagnostic/Non-Conductive	A-50
	569 High Pressure Hydraulic Hose	A-51
	573X Fast Response, 3000 psi.....	A-52
	575X Fast Response, 5000 psi.....	A-53
	580N/H580N High Pressure	A-54
	588N High Pressure, Non-Conductive.....	A-54
	590 General Hydraulic.....	A-36
	593 General Hydraulic.....	A-37
	83FR General Purpose	A-55
	1035A Power Cleaning.....	A-56
	1035HT Power Cleaning, Non-Conductive	A-57
	B9 General Purpose, Transfer Hose.....	A-58
	CNG Compressed Natural Gas	A-59
	D6 Hybrid, Constant Pressure, 3000 psi.....	A-22
	D6R Hybrid Hose, Constant Pressure, 3000 psi	A-23



For detailed ordering information, please consult price list or contact Parflex® Division.

Parker Hannifin Corporation | Parflex® Division | Ravenna, Ohio | parker.com/pfd

www.comoso.com

Parflex Thermoplastic Hose (cont.)

Duraflex 548N.....	A-67
H6 Constant Pressure, 3000 psi	A-28
HFS Hybrid, Fire-Screen®.....	A-24
HFSR Hybrid, Fire-Screen®	A-25
HFS2 Hybrid, Fire-Screen II®	A-26
HFS2R Hybrid, Fire-Screen II®	A-27
HJK Hybrid Highjack® Jackline	A-33
HLB Lubrication Line.....	A-60
HTB Hybrid Eliminator®, Compact.....	A-30
HTBR Hybrid Eliminator®, Compact	A-31
M8 High Pressure, Hydraulic.....	A-32
MSH Marine Steering	A-61
PTH Marine Power Tilt.....	A-62
R6 Hybrid Constant Pressure, Hydraulic Abrasion King®	A-29
S5N Predator® Water Jetting, 4000 psi.....	A-63
S6 Predator® Water Jetting, 2500 psi	A-64
S9 Predator® Water Jetting, 3000 psi.....	A-65
SLH Sewer Leader	A-66

Parflex Fluoropolymer Hose

919/919B PTFE Hose, Natural & Static Dissipative Core Tube	A-68
919J PTFE Hose, Silicone Cover	A-69
919U PTFE Hose, High Abrasion Resistance	A-70
929/929B Heavy Wall PTFE Hose, Natural & Static Dissipative Core Tube	A-71
929BJ PTFE Hose, Static Dissipative Core Tube, Silicone Cover.....	A-72
939/939B Convoluted PTFE Hose, Natural & Static Dissipative Core Tube	A-73
943B High Pressure PTFE Hose, Static Dissipative Core Tube, 3000 psi.....	A-74
944B High Pressure PTFE Hose, Static Dissipative Core Tube, up to 4500 psi	A-75
950B High Pressure PTFE Hose, Static Dissipative Core Tube, 4000 psi.....	A-76
955B High Pressure PTFE Hose, Static Dissipative Core Tube, 5500 psi.....	A-77

PAGE Fluoropolymer Hose

S30/S30B PTFE Hose, Nominal I.D., Natural & Static Dissipative Core Tube.....	A-78
S40/S40B Heavy Wall PTFE Hose, Nominal I.D., Natural & Static Dissipative Core Tube	A-79
STW/STB PTFE Hose, "True-Bore", Natural & Static Dissipative Core Tube	A-80
SBFW/SBFB PTFE Hose, PAGE-flex® SBF, Natural & Static Dissipative Core Tube.....	A-81
SCW/SCB Convoluted PTFE Hose, SS Braid, Natural & Static Dissipative Core Tube	A-82
PCW/PCB Convoluted PTFE Hose, PP Braid, Natural & Static Dissipative Core Tube	A-83
SCWW/SCBV Heavy Wall Convoluted PTFE Hose, SS Braid, Natural & Static Dissipative Core Tube	A-84
PCWW/PCBV Heavy Wall Convoluted PTFE Hose, PP Braid, Natural & Static Dissipative Core Tube	A-85
SCWW-FS/SCBV-FS Flare-Seal® PTFE Hose, SS Braid, Natural & Static Dissipative Core Tube	A-86
PCWW-FS/PCBV-FS Flare-Seal® PTFE Hose, PP Braid, Natural & Static Dissipative Core Tube.....	A-87
RCTW/RCTB EPDM Rubber Covered Hose, Natural & Static Dissipative Core Tube	A-88

For detailed ordering information, please consult price list or contact Parflex® Division.



Parflex Hose Visual Index

Parflex Thermoplastic		510A Refrigerant  A-38	510C General Hydraulic  A-39	518C Non-Conductive Hydraulic  A-40
		518D Non-Conductive Hydraulic  A-41	515H Compact/Lightweight  A-42	520N General Hydraulic  A-43
526BA Breathing Air Refill 6000 psi  A-44	527BA Breathing Air Refill 7000 psi  A-45	53DM DuraMax™ Low Temperature, 3000 psi  A-46	538DM DuraMax™ Low Temperature, Non-Conductive 3000 psi  A-46	
540N General Hydraulic  A-47	540P Specialty Water  A-48	55LT Low Temperature  A-49	560 560R General Hydraulic  A-34	
563 General Hydraulic  A-35	56DH Diagnostic Hose  A-50	568DH Non-Conductive Diagnostic Hose  A-50	569 High Pressure Hydraulic Hose  A-51	
573X Fast Response 3000 psi  A-52	575X Fast Response 5000 psi  A-53	580N H580N High Pressure  A-54	588N Non-Conductive High Pressure  A-54	
590 General Hydraulic Hose  A-36	593 General Hydraulic Hose  A-37	83FR General Purpose  A-55	1035A Power Cleaning  A-56	
1035HT High Temperature Power Cleaning  A-57	B9 General Purpose  A-58	CNG Compressed Natural Gas  A-59	D6 Constant Pressure, 3000 psi  A-22 HYBRID	
D6R Constant Pressure 3000 psi  A-23 HYBRID	Duraflex 548N Tool Hose  A-67	H6 Constant Pressure Hydraulic  A-28	HFS Fire-Screen®  A-24 HYBRID	



For detailed ordering information, please consult price list or contact Parflex® Division.

Parflex Hose Visual Index (cont.)

Parflex Thermoplastic (cont.)		HFSR Fire-Screen II®	HFS2 Fire-Screen®	HFS2R Fire-Screen II®
		 A-25 HYBRID	 A-26 HYBRID	 A-27 HYBRID
HJK Highjack® Jackline	HLB Lubrication Line	HTB Eliminator® Compact	HTBR Eliminator® Compact	
 A-33 HYBRID	 A-60	 A-30 HYBRID	 A-31 HYBRID	
M8 High Pressure Hydraulic	MSH Marine Steering	PTH Marine Power Tilt	R6 Constant Pressure Hydraulic	
 A-32	 A-61	 A-62	 A-29 HYBRID	
S5N Predator® Water Jetting 4000 psi	S6 Predator® Water Jetting 2500 psi	S9 Predator® Water Jetting 3000 psi	SLH Predator® Sewer Leader	
 A-63	 A-64	 A-65	 A-66	

Parflex PTFE		919 PTFE Hose	919B PTFE Hose with Static-Dissipative Tube	919J Silicone Covered PTFE Hose
		 A-68	 A-68	 A-69
919U High Abrasion Resistance PTFE Hose	929 Heavy Wall PTFE Hose	929B Heavy Wall PTFE Hose with Static-Dissipative Tube	929BJ Silicone Covered PTFE Hose with Static-Dissipative Tube	
 A-70	 A-71	 A-71	 A-72	
939 Convuluted PTFE Hose	939B Convuluted PTFE Hose with Static-Dissipative Tube	943B High Pressure PTFE Hose with Static-Dissipative Tube	944B High Pressure PTFE Hose with Static-Dissipative Tube	
 A-73	 A-73	 A-74	 A-75	
950B High Pressure PTFE Hose with Static-Dissipative Tube	955B High Pressure PTFE Hose with Static-Dissipative Tube			
 A-76	 A-77			

For detailed ordering information, please consult price list or contact Parflex® Division.

Parker Hannifin Corporation | Parflex® Division | Ravenna, Ohio | parker.com/pfd

www.comoso.com



Parflex Hose Visual Index (cont.)

PAGE Product Line PTFE & Specialty	S30 Industrial .030 wall with SS Braid	S30B Conductive Industrial .030 wal twith SS Braid	S40 Heavy Wall .040 with SS Braid
	 A-78	 A-78	 A-79
S40B Conductive Heavy Wall .040 with SS Braid	STW "True-Bore" with SS Braid	STB Conductive "True-Bore" with SS Braid	SBFW PAGE-flex® SBF
 A-79	 A-80	 A-80	 A-81
SBFB Conductive PAGE-flex® SBF	SCW Convolutd with SS Braid	SCB Conductive Convolutd with SS Braid	PCW Convolutd with PP Braid
 A-81	 A-82	 A-82	 A-83
PCB Conductive Convolutd with PP Braid	SCWV Heavy Wall Convolutd with SS Braid	SCBV Conductive Heavy Wall Convolutd with SS Braid	PCWV Heavy Wall Convolutd with PP Braid
 A-83	 A-84	 A-84	 A-85
PCBV Conductive Heavy Wall Convolutd PP Braid	SCWV-FS Flare-Seal® with SS Braid	SCBV-FS Conductive Flare-Seal® with SS Braid	PCWV-FS Flare-Seal® with PP Braid
 A-85	 A-86	 A-86	 A-87
PCBV-FS Conductive Flare-Seal® with PP Braid	RCTW EPDM Rubber Covered Natural	RCTB EPDM Rubber Covered Conductive	
 A-87	 A-88	 A-88	

Understanding Parflex Hoses

Parflex hoses are designed to handle extremes. They are used in some of the harshest applications around, such as over-the-sheave or aerial lift because they are specifically designed to handle extreme abrasion, temperatures, flexing, impulse and other factors that cause many hoses to fail.

Hydraulic & Pneumatic Hose Selection

Parflex offers several lines of hydraulic and pneumatic hoses; General Hydraulic, Specialty and Hybrid hoses. Specialty hoses were designed to solve specific application problems. Hybrid Hoses belong specifically to Parflex, with no exact competitor equivalents. These hoses were developed to cross typical SAE boundaries and meet specific challenges our customers were bringing to us.

The visual index and hose pages indicate which hoses are Hybrid designs.

Review the STAMPED guide (Size, Temperature, Media, Application, Pressure, End Configuration, and Delivery Preferences) on page 11 to help narrow your search for the desired product.

Fluoropolymer Selection

Parflex offers two lines of Fluoropolymer Hoses; the traditional Parflex PTFE hoses, many that meet 100R14 standards, and the PAGE hose line, comprised of specialty braid and construction options.

Hoses in PAGE product line are manufactured with materials that are compliant to the following standards:

- FDA 21 CFR 177.1550 and 177.2600
- USP Class VI
- Pharmacopoeia 3.1.9
- ISO 10093, Sections 5, 6 10 and 11
- USDA Standards
- 3A Standards

The visual index and hose pages indicate which hoses are from the PAGE product line.

Hose Assemblies

To determine hose part numbers for assemblies use the following nomenclature pages:

- Parflex Thermoplastic Hose Assembly Nomenclature pg. A-18
- Parflex PTFE Hose Assembly Nomenclature pg. A-19
- PAGE Product Line - Industrial S30 & S40 Hose Assembly Nomenclature pg. A-20
- PAGE Product Line - "True-Bore" & Convuluted Hose Assembly Nomenclature pg. A-21

For detailed ordering information, please consult price list or contact Parflex® Division.

Parker Hannifin Corporation | Parflex® Division | Ravenna, Ohio | parker.com/pfd

www.comoso.com



How to Read the Hose Section

1 Part Number	2 Nominal I.D.		3 Maximum O.D.		4 Maximum Working Pressure		5 Minimum Bend Radius		6 Weight		7 Permanent Fitting Series
#											
	inch	mm	inch	mm	psi/73°F	bar/23°C	inch	mm	lbs./ft.	kg./mtr.	
D604	1/4	6	.51	13	3,000	20.7	2.00	51	.12	.18	43/HY

Base part number example.

NOTE: The primary dimensions are in black. The metric/inch equivalents appear in blue.

1 Part Number

Hose Series Part Number - When two part numbers are listed, the second number is the static-dissipative or non-conductive design.

2 Inside Diameter

A critical value along with pressure when calculating fluid flow rate and pressure drop.

3 Outside Diameter

A critical measurement when considering hose fittings and applications where envelope size is limited.

4 Working Pressure

Working pressure rating must meet or exceed the maximum operating pressure of the system including pressure spikes.

5 Minimum Bend Radius

Minimum radius that the hose can be bent. Exceeding the bend radius can cause kinking, inner tube washout, or excessive stress on reinforcement resulting in shortened service life.

6 Weight

Provided where weight is a critical parameter in the design of the system.

7 Approved Fitting

Permanent or field attachable fitting series approved for selected hose. Products with no fitting selection are only available in factory built assemblies.

Hose Constructions

Thermoplastic Hose Construction

1. Core

Contains Media

Materials: Nylon, Polyethylene, Polyurethane, Copolyester

2. Reinforcement

Provides Resistance to Internal Pressure

Materials: Fiber (Nylon, Polyester, Aramid), Steel, Stainless Steel

3. Cover

Protects Reinforcement

Advantages: Aesthetics, Color and Marking

Materials: Polyurethane, Nylon, Synthetic Rubber, Copolyester, Polyurethane, Proprietary Blend (PFX)

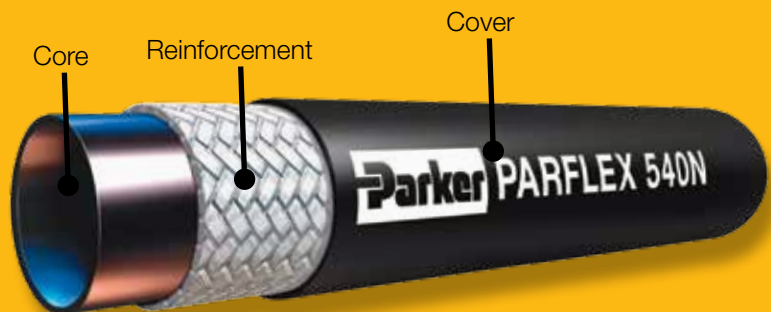

Fluoropolymer Hose Construction

Smoothbore Core

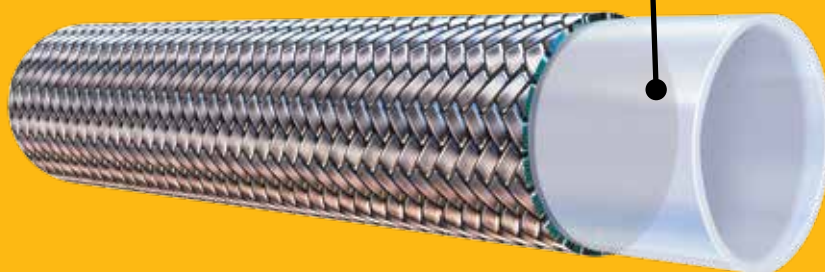

Convuluted Core

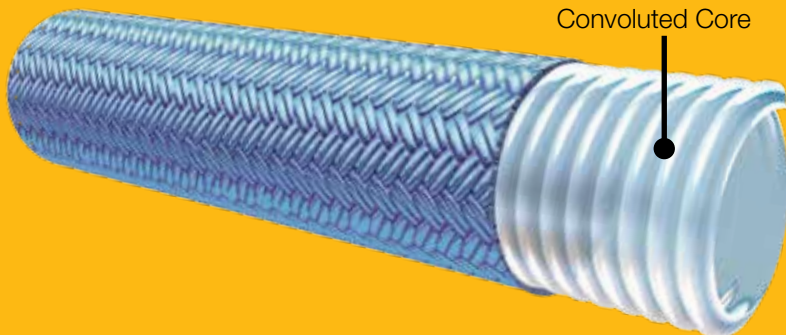

1. Core

Contains Media

Materials: PTFE Smoothbore or Convuluted, PFA

2. Reinforcement

Provides Resistance to Internal Pressure

Materials: Steel, Stainless Steel, Polypropylene, Nomex®, Proprietary Composite

3. Cover or Protective Sleeve

Protects Reinforcement

Materials: Silicone, Polyolefin, EPDM Rubber

Nomex® is a registered trademark of Dupont.

For detailed ordering information, please consult price list or contact Parflex® Division.

Parker Hannifin Corporation | Parflex® Division | Ravenna, Ohio | parker.com/pfd

www.comoso.com



Thermoplastic Hose Selection psi

Reinforcement Type		PSI Thermoplastic Hose Working Pressures												
		3/32	1/8	3/16	1/4	5/16	3/8	1/2	5/8	3/4	1	1 1/4	1 1/2	
Dash Size		-1.5	-2	-3	-4	-5	-6	-8	-10	-12	-16	-20	-24	
Hose	Description	psi	psi	psi	psi	psi	psi	psi	psi	psi	psi	psi	psi	
Wire	D6/D6R Hybrid - Constant Pressure Hydraulic				3000		3000	3000	3000	3000	3000			
	D6R Hybrid - Constant Pressure Hydraulic				3000		3000	3000	3000	3000	3000			
	H6 Constrant Pressure Hydraulic				3000	3000	3000	3000	3000	3000				
	HFS Hybrid - General Hydraulic				3000	3000	2500	2500		1500	1250			
	HFSR Hybrid - General Hydraulic				3000	3000	2500	2500		1500	1250			
	HFS2 Hybrid - General Hydraulic				5000		4000	3500	2750	2250	2000			
	HFS2R Hybrid - General Hydraulic				5000		4000	3500	2750	2250	2000			
	R6 Constrant Pressure Hydraulic				3000		3000	3000	3000	3000	3000			
	M8 Hybrid - High Pressure Hydraulic						4000	4000	4000					
	HTB Hybrid - Compact High Pressure				7000		5500	5000	4000	4000	3500			
	HTBR Hybrid - Compact High Pressure				7000		5500	5000	4000	4000	3500			
	HJK Hybrid - Jackline				10000									
	560/560R General Hydraulic			3500	3250	3000	2750	2500	2000	1750				
	563 Constant Pressure Hydraulic				3000		3000	3000						
	590 General Hydraulic			5000	5000		4000	3500	3000	2500	2000			
593 General Hydraulic									3000	3250				
Fiber	510A Industrial Refrigerant		2500	3000	2750	2500	2250	2000		1250	1000			
	510C General Hydraulic		2500	3250	3000	2500	2250	2250		1250	1000			
	518C Non-conductive Hydraulic		2500	3250	3000	2500	2250	2250		1250	1000			
	518D Non-conductive Hydraulic		3000	3250	3000	2500	2250	2250		1250				
	515H Compact/Lightweight Hydraulic			2175	2000	1750	1500	1500						
	520N / 528N General Hydraulic / Non-conductive Hydraulic			5000	5000	4500	4000	3500						
	526BA Breathing Air Refill			6000	6000		6000							
	527BA Breathing Air Refill			7000	7000									
	53DM / 538DM Low Temperature Hydraulic			3000	3000	3000	3000	3000	3000	3000				
	540N General Hydraulic		3000	3000	2750	2500	2250	2000		1250				
	540P Specialty Water				2750		2250	2000		1250				
	55LT Low Temperature Hydraulic		3000	3250	3000	2500	2250	2000		1250				
	56DH / 568DH Diagnostic	6000	6000											
	569 High Pressure				10000									
	573X Fast Response Hydraulic			3000							3000			
	575X Fast Response Hydraulic			5000	5000		5000	5000		5000	5000			
	580N / 588N General Hydraulic / Non-conductive Hydraulic				5000		4000	3500	2750	2250	2000			
	H580N General Hydraulic										3000			
	1035A Power Cleaning				1500	1200								
	1035HT Power Cleaning			2000	1750	1500								
	83FR General Purpose Air/Water				300		300	300		300				
	B9 General Purpose Air/Water			250	250	250	250	250	250					
	5CNG Compressed Natural Gas			5000	5000		5000	5000		5000	5000			
	HLB Lubrication		3000	3000										
	MSH Marine Steering					1000	1000							
PTH Power Tilt				3000										
S5N Sewer Cleaning - Lateral Cleaning							4000							
S6 Sewer Cleaning									2500	2500	2500	2500		
S9 Sewer Cleaning									3000	3000				
SLH Sewer Cleaning Leader Hose							4000	4000	3000	3000				
Duraflex Aerial Lift - Hydraulic Tool							2250							

*View Government & Agency Specifications for exceptions, pg. G-60

Legend

N – Nylon
NP – Neoprene

P – Copolyester
PE – Polyethylene

PFX – Proprietary Mat'l
S – Silicone

R – Rubber
U – Urethane

F – Fiber



For detailed ordering information, please consult price list or contact Parflex® Division.

Construction/Specifications

PSI Thermoplastic Construction and Specifications									Reinforcement Type
Core Tube	Reinforcement Material	Cover Material	SAE Specification	Additional Specifications	Page #	Description	Hose		
P	Wire	R	100R17	MSHA IC-40/32	A-22	Hybrid - Constant Pressure Hydraulic	D6		Wire
P	Wire	R		MSHA/ ISO 11237	A-23	Hybrid - Constant Pressure Hydraulic	D6R		
P	Wire	P	100R17		A-28	Constant Pressure Hydraulic	H6		
P	Wire	R	100R1 / J1942	MSHA IC-40/32	A-24	Hybrid - General Hydraulic	HFS		
P	Wire	R	100R1		A-25	Hybrid - General Hydraulic	HFSR		
P	Wire	R	100R2 / 100R16 / J1942	MSHA IC-40/32	A-26	Hybrid - General Hydraulic	HFS2		
P	Wire	R	100R16	MSHA IC-40/32	A-27	Hybrid - General Hydraulic	HFS2R		
P	Wire	F	100R17		A-29	Constant Pressure Hydraulic	R6		
P	Wire	R	100R12	MSHA IC-40/32	A-32	Hybrid - High Pressure Hydraulic	M8		
P	Wire	R	J1942	MSHA IC-40/32	A-30	Hybrid - Compact High Pressure	HTB		
P	Wire	R		MSHA IC-40/32	A-31	Hybrid - Compact High Pressure	HTBR		
P	Wire	R	-	IJ-100/MSHA	A-33	Hybrid - Jackline	HJK		
P	Wire	U	100R1	MSHA IC-40/32 / DNV	A-34	General Hydraulic	560/560R		
P	Wire	U	100R17	MSHA IC-40/32	A-35	Constant Pressure Hydraulic	563		
P	Wire	U	100R2 / 100R16	DNV/ABS*	A-36	General Hydraulic	590		
P / N	Wire	U	100R2	MSHA IC-40/32/ABS	A-37	General Hydraulic	593		
PFX	Fiber	U	100R7	MSHA IC-40/32*	A-38	Industrial Refrigerant	510A		Fiber
P	Fiber	PFX	100R7	MSHA IC-40/32*/DNV	A-39	General Hydraulic	510C		
P	Fiber	PFX	100R7	DNV	A-40	Non-conductive Hydraulic	518C		
N	Fiber	PFX	100R7	DNV	A-41	Non-conductive Hydraulic	518D		
P	Fiber	U	-	MSHA IC-40/32	A-42	Compact/Lightweight Hydraulic	515H		
N	Fiber	U	100R8	MSHA IC-40/32 / DNV*	A-43	General Hydraulic / Non-conductive Hydraulic	520N / 528N		
N	Fiber	U	-	CGA / NFPA 1901	A-44	Breathing Air Refill	526BA		
N	Fiber	U	-	CGA / NFPA 1901	A-45	Breathing Air Refill	527BA		
P	Fiber	P	100R18		A-46	Low Temperature Hydraulic	53DM / 538DM		
N	Fiber	U	100R7	MSHA IC-40/32 / DNV	A-47	General Hydraulic	540N		
PE	Fiber	U	100R7	FDA	A-48	Specialty Water	540P		
P	Fiber	P	100R7		A-49	Low Temperature Hydraulic	55LT		
N	Fiber	U	-	MSHA IC-40/32*	A-50	Diagnostic	56DH / 568DH		
N	Fiber	U	-	IJ-100	A-51	High Pressure	569		
N	Fiber	U	-	MSHA IC-40/32 / DNV*	A-52	Fast Response Hydraulic	573X		
N	Fiber	U	-	MSHA IC-40/32 / DNV	A-53	Fast Response Hydraulic	575X		
N	Fiber	U	100R8	MSHA IC-40/32 / DNV*	A-54	General Hydraulic / Non-conductive	580N / 588N		
N	Fiber	U	100R8	DNV	A-54	General Hydraulic	H580N		
PFX	Fiber	U	-		A-56	Power Cleaning	1035A		
N	Fiber	U	-		A-57	Power Cleaning	1035HT		
U	Fiber	U	-	MSHA IC-40/32	A-55	General Purpose Air/Water	83FR		
U	Fiber	U	-		A-58	General Purpose Air/Water	B9		
N	Fiber	U	-	ANSI IAS NGV4.2-CSA 12.52 / ECE R110*	A-59	Compressed Natural Gas	CNG		
P	Fiber	U	-	MSHA IC-40/32	A-60	Lubrication	HLB		
N	Fiber	U	-		A-61	Marine Steering	MSH		
N	Fiber / SS Wire	U	-		A-62	Power Tilt	PTH		
P	Fiber	U	-	Wastec WRP05-1996	A-63	Sewer Cleaning - Lateral Cleaning	S5N		
P	Fiber	U	-	Wastec WRP05-1996	A-64	Sewer Cleaning	S6		
P	Fiber	U	-	Wastec WRP05-1996	A-65	Sewer Cleaning	S9		
P	Wire	R	-		A-66	Sewer Cleaning Leader Hose	SLH		
N	Fiber	U	100R7		A-67	Aerial Lift - Hydraulic Tool	Duraflex - 548N		

For detailed ordering information, please consult price list or contact Parflex® Division.



Fluoropolymer Hose Selection psi

Reinforcement Type		PSI Fluoropolymer Hose Working Pressures															
		Fractional Size	Nominal Sizes														
			1/8	3/16	1/4	5/16	13/32	1/2	5/8	7/8	1-1/8	1/8	1/4	3/8	1/2	5/8	
			15/64	7/16	29/32												
Dash Size		-3	-4	-5	-6	-8	-10	-12	-16	-20	-3	-4	-6	-8	-10		
		psi	psi	psi	psi	psi	psi	psi	psi	psi	psi	psi	psi	psi	psi		
Wire	919	PTFE Hose	3000	3000	3000	2500	2000	1500	1200	1000	625						
	919B	PTFE Hose with static-dissipative core		3000	3000	2500	2000										
	919J	Silicone Covered PTFE Hose		3000	3000	2500	2000	1500	1200								
	919U	High Abrasion Resistance PTFE Hose		3000		2500	2000		1200	1000							
	929	Heavy Wall PTFE Hose		3000		2500	2000										
	929B	Heavy Wall PTFE Hose with static-dissipative core		3000		2500	2000		1200	1250							
	929BJ	Silicone Covered PTFE Hose with static-dissipative core		3000		2500	2000		1200	1250							
	939	Convuluted PTFE Hose												1500	1350	1000	
	939B	Convuluted PTFE Hose with static-dissipative core												1500	1350	1000	
	943B	High Pressure PTFE Hose with static-dissipative core				3000	3000	3000	3000	3000							
	944B	High Pressure PTFE Hose with static-dissipative core		4500		4500	4500	4500	4500	4000							
	950B	High Pressure PTFE Hose with static-dissipative core		4000		4000	4000	4000	4000	4000							
	955B	High Pressure PTFE Hose with static-dissipative core		5500		5500	5500	5500	5500	5500							
	S30	PAGE Ind. PTFE Hose		3000	3000	2500	2000	1750	1500	1000							
	S30B	PAGE Ind. PTFE Hose with static-dissipative core		3000	3000	2500	2000	1750	1500	1000							
	S40	PAGE Ind. Heavy Wall PTFE Hose		3000	3000	2500	2000	1750	1500	1000							
	S40B	PAGE Ind. Heavy Wall PTFE Hose with static-dissipative core		3000	3000	2500	2000	1750	1500	1000							
	STW Z-STW*	PAGE Heavy Wall PTFE Hose *Double Braid										3000	3000	2000	1750		
	STB Z-STB*	PAGE Heavy Wall PTFE Hose with static-dissipative core *Double Braid										3000	3000	2000	1750		
	SCW	PAGE Convuluted PTFE Hose											1500	1500	1500		
SCB	PAGE Convuluted PTFE Hose with static-dissipative core											1500	1500	1500			
SCWV	PAGE Heavy Wall Convuluted PTFE Hose													1500			
SCBV	PAGE Heavy Wall Convuluted PTFE Hose with static-dissipative core													1500			
SCWV-FS	PAGE Flare-Seal® PTFE Hose													500			
SCBV-FS	PAGE Flare-Seal® PTFE Hose with static-dissipative core													500			
Fiber	PCW	PAGE Convuluted PTFE Hose, PP Braid										350	350	300			
	PCB	PAGE Convuluted PTFE Hose with static-dissipative core, PP Braid										350	350	300			
	PCWV	PAGE Heavy Wall Convuluted PTFE Hose, PP Braid												300			
	PCBV	PAGE Heavy Wall Convuluted PTFE Hose with static-dissipative core, PP Braid												300			
	PCWV-FS	PAGE Flare-Seal® PTFE Hose, PP Braid												300			
	PCBV-FS	PAGE Flare-Seal® PTFE Hose with static-dissipative core, PP Braid												300			
	RCTW	PAGE Rubber Covered EPDM													500		
Other	RCTB	PAGE Rubber Covered EPDM with static-dissipative core													500		
	SBFW	PAGE Page-Flex® SBF												300	300		
	SBFB	PAGE Page-Flex® SBF with static-dissipative core												300	300		

*Z indicates double braid.

Legend

PTFE – Polytetrafluoroethylene

PTFE-S – Polytetrafluoroethylene, Static Dissipative

FEP – Fluorinated Ethylene Propylene

PFA – Perfluoroalkoxy



For detailed ordering information, please consult price list or contact Parflex® Division.

Parker Hannifin Corporation | Parflex® Division | Ravenna, Ohio | parker.com/pfd

www.comoso.com

Construction/Specifications

Hose
A

PSI Fluoropolymer Construction and Specifications														Reinforcement Type
3/4	1	1 1/4	1 1/2	2	2-1/2	3	4					Fractional Size		
-12	-16	-20	-24	-32	-40	-48	-64	Core Tube	Reinforcement Material	Cover Material	Page #	Dash Size		
psi	psi	psi	psi	psi	psi	psi	psi							
								PTFE	SS Wire	—	A-65	PTFE Hose	919	
								PTFE-S	SS Wire	—	A-65	PTFE Hose with static-dissipative core	919B	
								PTFE	SS Wire	S	A-66	Silicone Covered PTFE Hose	919J	
								PTFE	SS Wire	U	A-67	High Abrasion Resistance PTFE Hose	919U	
								PTFE	SS Wire	—	A-68	Heavy Wall PTFE Hose	929	
								PTFE-S	SS Wire	—	A-68	Heavy Wall PTFE Hose with static-dissipative core	929B	
								PTFE-S	SS Wire	S	A-69	Silicone Covered PTFE Hose with static-dissipative core	929BJ	
	1100	1000	1000	750	250			PTFE	SS Wire	—	A-70	Convoluted PTFE Hose	939	
	1100	1000	1000	1000	1000			PTFE-S	SS Wire	—	A-70	Convoluted PTFE Hose with static-dissipative core	939B	
								PTFE-S	SS Wire	—	A-71	High Pressure PTFE Hose with static-dissipative core	943B	
								PTFE-S	SS Wire	—	A-72	High Pressure PTFE Hose with static-dissipative core	944B	
								PTFE-S	SS Wire	—	A-73	High Pressure PTFE Hose with static-dissipative core	950B	
								PTFE-S	SS Wire	—	A-74	High Pressure PTFE Hose with static-dissipative core	955B	
								PTFE	SS Wire	—	A-75	PAGE Ind. PTFE Hose	S30	
								PTFE-S	SS Wire	—	A-75	PAGE Ind. PTFE Hose with static-dissipative core	S30B	
								PTFE	SS Wire	—	A-76	PAGE Ind. Heavy Wall PTFE Hose	S40	
								PTFE-S	SS Wire	—	A-76	PAGE Ind. Heavy Wall PTFE Hose with static-dissipative core	S40B	
	1000	1000	1000*	900*				PTFE	SS Wire	—	A-77	PAGE Heavy Wall PTFE Hose *Double Braid	STW Z-STW*	
	1000	1000	1000*	900*				PTFE-S	SS Wire	—	A-77	PAGE Heavy Wall PTFE Hose with static-dissipative core *Double Braid	STB Z-STB*	
	1200	1000	750	650	450			PTFE	SS Wire	—	A-82	PAGE Convoluted PTFE Hose	SCW	
	1200	1000	750	650	450			PTFE-S	SS Wire	—	A-82	PAGE Convoluted PTFE Hose with static-dissipative core	SCB	
	1200	1000	750	650	450	200	175	150	PTFE	SS Wire	—	A-84	PAGE Heavy Wall Convoluted PTFE Hose	SCWV
	1200	1000	750	650	450	200	175	150	PTFE-S	SS Wire	—	A-84	PAGE Heavy Wall Convoluted PTFE Hose with static-dissipative core	SCBV
	425	350	325	300	250	200	175	150	PTFE	SS Wire	—	A-86	PAGE Flare-Seal® PTFE Hose	SCWV-FS
	425	350	325	300	250	200	175	150	PTFE-S	SS Wire	—	A-86	PAGE Flare-Seal® PTFE Hose with static-dissipative core	SCBV-FS
	250	250	200	200	200	200	200	200	PTFE	PP	—	A-83	PAGE Convoluted PTFE Hose, PP Braid	PCW
	250	250	200	200	200	200	200	200	PTFE-S	PP	—	A-83	PAGE Convoluted PTFE Hose with static-dissipative core, PP Braid	PCB
	250	250	200	200	200	150	125	100	PTFE	PP	—	A-85	PAGE Heavy Wall Convoluted PTFE Hose, PP Braid	PCWV
	250	250	200	200	200	150	125	100	PTFE-S	PP	—	A-85	PAGE Heavy Wall Convoluted PTFE Hose with static-dissipative core, PP Braid	PCBV
	250	250	200	200	200	150	125	100	PTFE	PP	—	A-87	PAGE Flare-Seal® PTFE Hose, PP Braid	PCWV-FS
	250	250	200	200	200	150	125	100	PTFE-S	PP	—	A-87	PAGE Flare-Seal® PTFE Hose with static-dissipative core, PP Braid	PCBV-FS
	500	450	375	375	300	200	200	150	FEP	Double Wire Helix	EPDM	A-88	PAGE Rubber Covered EPDM	RCTW
	500	450	375	375	300	200	200	150	PFA-S	Double Wire Helix	EPDM	A-88	PAGE Rubber Covered EPDM with static-dissipative core	RCTB
	250	250		200					PFA	Bonded Wire-Silicone-Fiber	—	A-78	PAGE Page-Flex® SBF	SBFW
	250	250		200					PFA-S	Bonded Wire-Silicone-Fiber	—	A-78	PAGE Page-Flex® SBF with static-dissipative core	SBFB

PFA-S – Perfluoroalkoxy, Static Dissipative
PP – Polypropylene

S – Silicone
U – Polyurethane

For detailed ordering information, please consult price list or contact Parflex® Division.

Parker Hannifin Corporation | Parflex® Division | Ravenna, Ohio | parker.com/pfd

www.comoso.com



B Tubing

C Coiled Air Hose & Fittings

D Transportation

E Fittings

F Tooling, Equipment & Accessories

G General Technical

Thermoplastic Hose Selection MPa

Reinforcement Type		MPa Thermoplastic Hose Working Pressures													
		Dash Size		3/32	1/8	3/16	1/4	5/16	3/8	1/2	5/8	3/4	1	1 1/4	1 1/2
		Hose	Description	-1.5	-2	-3	-4	-5	-6	-8	-10	-12	-16	-20	-24
			psi	psi	psi	psi	psi	psi	psi	psi	psi	psi	psi	psi	
Wire	D6/D6R	Hybrid - Constant Pressure Hydraulic				20.7		20.7	20.7	20.7	20.7	20.7			
	D6R	Hybrid - Constant Pressure Hydraulic				20.7		20.7	20.7	20.7	20.7	20.7			
	H6	Constrant Pressure Hydraulic				20.7	20.7	20.7	20.7	20.7	20.7				
	HFS	Hybrid - General Hydraulic				20.7	20.7	17.2	17.2		10.3	8.6			
	HFSR	Hybrid - General Hydraulic				20.7	20.7	17.2	17.2		10.3	8.6			
	HFS2	Hybrid - General Hydraulic				34.5		27.6	24.1	19.0	15.5	13.8			
	HFS2R	Hybrid - General Hydraulic				34.5		27.6	24.1	19.0	15.5	13.8			
	R6	Constrant Pressure Hydraulic				20.7		20.7	20.7	20.7	20.7	20.7			
	M8	Hybrid - High Pressure Hydraulic						27.6	27.6	27.6					
	HTB	Hybrid - Compact High Pressure				48.3		37.9	34.5	27.6	27.6	24.1			
	HTBR	Hybrid - Compact High Pressure				48.3		37.9	34.5	27.6	27.6	24.1			
	HJK	Hybrid - Jackline				68.9									
	560/560R	General Hydraulic			24.1	31.7	20.7	19.0	17.2	13.8	12.1				
	563	Constant Pressure Hydraulic				20.7		20.7	20.7						
	590	General Hydraulic			34.5	34.5		27.6	24.1	20.7	17.2	13.8			
	593	General Hydraulic									20.7	31.7			
	Fiber	510A	Industrial Refrigerant		17.2	20.7	10.3	17.2	15.5	13.8		8.6	6.9		
510C		General Hydraulic		17.2	31.7	20.7	17.2	15.5	15.5		8.6	6.9			
518C		Non-conductive Hydraulic		17.2	31.7	20.7	17.2	15.5	15.5		8.6	6.9			
518D		Non-conductive Hydraulic		20.7	31.7	20.7	17.2	15.5	15.5		8.6				
515H		Compact/Lightweight Hydraulic			15.0	13.8	12.1	10.3	10.3						
520N / 528N		General Hydraulic / Non-conductive Hydraulic			34.5	34.5	31.0	27.6	24.1						
526BA		Breathing Air Refill			41.4	41.4		41.4							
527BA		Breathing Air Refill			48.3	48.3									
53DM / 538DM		Low Temperature Hydraulic			20.7	20.7	20.7	20.7	20.7	20.7	20.7				
540N		General Hydraulic		20.7	20.7	19.0	17.2	15.5	13.8		8.6				
540P		Specialty Water				19.0		15.5	13.8		8.6				
55LT		Low Temperature Hydraulic		20.7	31.7	20.7	17.2	15.5	13.8		8.6				
56DH / 568DH		Diagnostic	41.4	41.4											
569		High Pressure				70.0									
573X		Fast Response Hydraulic			20.7								20.7		
575X		Fast Response Hydraulic			34.5	34.5		34.5	34.5		34.5	34.5			
580N / 588N		General Hydraulic / Non-conductive Hydraulic				34.5		27.6	24.1	10.3	15.5	13.8			
H580N		General Hydraulic										20.7			
1035A		Power Cleaning				10.3	8.3								
1035HT		Power Cleaning			13.8	12.1	10.3								
83FR		General Purpose Air/Water				2.1		2.1	2.1		2.1				
B9		General Purpose Air/Water			1.7	1.7	1.7	1.7	1.7	1.7					
5CNG		Compressed Natural Gas			34.5	34.5		34.5	34.5		34.5	34.5			
HLB		Lubrication		20.7	20.7										
MSH		Marine Steering					6.9	6.9							
PTH		Power Tilt				20.7									
S5N		Sewer Cleaning - Lateral Cleaning							27.6						
S6		Sewer Cleaning									17.2	17.2	17.2	17.2	
S9	Sewer Cleaning									20.7	20.7				
SLH	Sewer Cleaning Leader Hose							27.6	27.6	20.7	20.7				
Duraflex	Aerial Lift - Hydraulic Tool						15.5								



Construction/Specifications

MPa Thermoplastic Hose Working Pressures									Reinforcement Type
Core Tube	Reinforcement Material	Cover Material	SAE Specification	Additional Specifications	Page #	Description	Hose		
P	Wire	R	100R17	MSHA IC-40/32	A-22	Hybrid - Constant Pressure Hydraulic	D6	Wire	
P	Wire	R		MSHA/ ISO 11237	A-23	Hybrid - Constant Pressure Hydraulic	D6R		
P	Wire	P	100R17		A-28	Constrant Pressure Hydraulic	H6		
P	Wire	R	100R1 / J1942	MSHA IC-40/32	A-24	Hybrid - General Hydraulic	HFS		
P	Wire	R	100R1		A-25	Hybrid - General Hydraulic	HFSR		
P	Wire	R	100R2 / 100R16 / J1942	MSHA IC-40/32	A-26	Hybrid - General Hydraulic	HFS2		
P	Wire	R	100R16	MSHA IC-40/32	A-27	Hybrid - General Hydraulic	HFS2R		
P	Wire	F	100R17		A-29	Constrant Pressure Hydraulic	R6		
P	Wire	R	100R12	MSHA IC-40/32	A-32	Hybrid - High Pressure Hydraulic	M8		
P	Wire	R	J1942	MSHA IC-40/32	A-30	Hybrid - Compact High Pressure	HTB		
P	Wire	R		MSHA IC-40/32	A-31	Hybrid - Compact High Pressure	HTBR		
P	Wire	R	-	IJ-100/MSHA	A-33	Hybrid - Jackline	HJK		
P	Wire	U	100R1	MSHA IC-40/32 / DNV	A-34	General Hydraulic	560/560R		
P	Wire	U	100R17	MSHA IC-40/32	A-35	Constant Pressure Hydraulic	563		
P	Wire	U	100R2 / 100R16	DNV/ABS*	A-36	General Hydraulic	590		
P / N	Wire	U	100R2	MSHA IC-40/32/ABS	A-37	General Hydraulic	593		
PFX	Fiber	U	100R7	MSHA IC-40/32*	A-38	Industrial Refrigerant	510A		
P	Fiber	PFX	100R7	MSHA IC-40/32*/DNV	A-39	General Hydraulic	510C		
P	Fiber	PFX	100R7	DNV	A-40	Non-conductive Hydraulic	518C		
N	Fiber	PFX	100R7	DNV	A-41	Non-conductive Hydraulic	518D		
P	Fiber	U	-	MSHA IC-40/32	A-42	Compact/Lightweight Hydraulic	515H		
N	Fiber	U	100R8	MSHA IC-40/32 / DNV*	A-43	General Hydraulic / Non-conductive Hydraulic	520N / 528N		
N	Fiber	U	-	CGA / NFPA 1901	A-44	Breathing Air Refill	526BA		
N	Fiber	U	-	CGA / NFPA 1901	A-45	Breathing Air Refill	527BA		
P	Fiber	P	100R18		A-46	Low Temperature Hydraulic	53DM / 538DM		
N	Fiber	U	100R7	MSHA IC-40/32 / DNV	A-47	General Hydraulic	540N		
PE	Fiber	U	100R7	FDA	A-48	Specialty Water	540P		
P	Fiber	P	100R7		A-49	Low Temperature Hydraulic	55LT		
N	Fiber	U	-	MSHA IC-40/32*	A-50	Diagnostic	56DH / 568DH		
N	Fiber	U	-	IJ-100	A-51	High Pressure	569		
N	Fiber	U	-	MSHA IC-40/32 / DNV*	A-52	Fast Response Hydraulic	573X		
N	Fiber	U	-	MSHA IC-40/32 / DNV	A-53	Fast Response Hydraulic	575X		
N	Fiber	U	100R8	MSHA IC-40/32 / DNV*	A-54	General Hydraulic / Non-conductive	580N / 588N		
N	Fiber	U	100R8	DNV	A-54	General Hydraulic	H580N		
PFX	Fiber	U	-		A-56	Power Cleaning	1035A		
N	Fiber	U	-		A-57	Power Cleaning	1035HT		
U	Fiber	U	-	MSHA IC-40/32	A-55	General Purpose Air/Water	83FR		
U	Fiber	U	-		A-58	General Purpose Air/Water	B9		
N	Fiber	U	-	ANSI IAS NGV4.2-CSA 12.52 / ECE R110*	A-59	Compressed Natural Gas	CNG		
P	Fiber	U	-	MSHA IC-40/32	A-60	Lubrication	HLB		
N	Fiber	U	-		A-61	Marine Steering	MSH		
N	Fiber / SS Wire	U	-		A-62	Power Tilt	PTH		
P	Fiber	U	-	Wastec WRP05-1996	A-63	Sewer Cleaning - Lateral Cleaning	S5N		
P	Fiber	U	-	Wastec WRP05-1996	A-64	Sewer Cleaning	S6		
P	Fiber	U	-	Wastec WRP05-1996	A-65	Sewer Cleaning	S9		
P	Wire	R	-		A-66	Sewer Cleaning Leader Hose	SLH		
N	Fiber	U	100R7		A-67	Aerial Lift - Hydraulic Tool	Duraflex - 548N		

*View Government & Agency Specifications for exceptions, pg. G-60

Legend

- N – Nylon
- NP – Neoprene
- P – Copolyester
- PE – Polyethylene
- PFX – Proprietary Mat'l
- S – Silicone
- R – Rubber
- U – Urethane
- F – Fiber

For detailed ordering information, please consult price list or contact Parflex® Division.



Fluoropolymer Hose Selection MPa

Reinforcement Type		MPa Fluoropolymer Hose Working Pressures														
		Fractional Size	Nominal Sizes													
			1/8	3/16	1/4	5/16	13/32	1/2	5/8	7/8	1-1/8	1/8	1/4	3/8	1/2	5/8
				15/64			7/16			29/32		-3	-4	-6	-8	-10.3
Dash Size		-3	-4	-5	-6	-8	-10	-12.1	-16	-20	MPa	MPa	MPa	MPa	MPa	
		MPa	MPa	MPa	MPa	MPa	MPa	MPa	MPa	MPa	MPa	MPa	MPa	MPa	MPa	
B	919	PTFE Hose	20.7	20.7	20.7	17.2	13.8	10.3	8.3	6.9	4.3					
	919B	PTFE Hose with static-dissipative core		20.7	20.7	17.2	13.8									
	919J	Silicone Covered PTFE Hose		20.7	20.7	17.2	13.8	10.3	8.3							
	919U	High Abrasion Resistance PTFE Hose		20.7		17.2	13.8		8.3	6.9						
	929	Heavy Wall PTFE Hose		20.7		17.2	13.8									
	929B	Heavy Wall PTFE Hose with static-dissipative core		20.7		17.2	13.8		8.3	9						
	929BJ	Silicone Covered PTFE Hose with static-dissipative core		20.7		17.2	13.8		8.3	9						
	939	Convuluted PTFE Hose											10.3	9.3	6.9	
	939B	Convuluted PTFE Hose with static-dissipative core											10.3	9.3	6.9	
	943B	High Pressure PTFE Hose with static-dissipative core				20.7	20.7	20.7	20.7	20.7						
C	944B	High Pressure PTFE Hose with static-dissipative core		31.0		31.0	31.0	31.0	31.0	27.5						
	950B	High Pressure PTFE Hose with static-dissipative core		27.5		27.5	27.5	27.5	27.5	27.5						
	955B	High Pressure PTFE Hose with static-dissipative core		37.9		37.9	37.9	37.9	37.9	37.9						
	S30	PAGE Ind. PTFE Hose		20.7	20.7	17.2	13.8	12.1	10.3	6.9						
	S30B	PAGE Ind. PTFE Hose with static-dissipative core		20.7	20.7	17.2	13.8	12.1	10.3	6.9						
	S40	PAGE Ind. Heavy Wall PTFE Hose		20.7	20.7	17.2	13.8	12.1	10.3	6.9						
	S40B	PAGE Ind. Heavy Wall PTFE Hose with static-dissipative core		20.7	20.7	17.2	13.8	12.1	10.3	6.9						
	STW Z-STW*	PAGE Heavy Wall PTFE Hose *Double Braid										20.7	20.7	13.8	12.1	
	STB Z-STB*	PAGE Heavy Wall PTFE Hose with static-dissipative core *Double Braid										20.7	20.7	13.8	12.1	
	SCW	PAGE Convuluted PTFE Hose											10.3	10.3	10.3	
D	SCB	PAGE Convuluted PTFE Hose with static-dissipative core										10.3	10.3	10.3		
	SCWV	PAGE Heavy Wall Convuluted PTFE Hose												10.3		
	SCBV	PAGE Heavy Wall Convuluted PTFE Hose with static-dissipative core												10.3		
	SCWV-FS	PAGE Flare-Seal® PTFE Hose												3.5		
	SCBV-FS	PAGE Flare-Seal® PTFE Hose with static-dissipative core												3.5		
	PCW	PAGE Convuluted PTFE Hose, PP Braid										2.4	2.4	2.1		
	PCB	PAGE Convuluted PTFE Hose with static-dissipative core, PP Braid										2.4	2.4	2.1		
	PCWV	PAGE Heavy Wall Convuluted PTFE Hose, PP Braid												2.1		
	PCBV	PAGE Heavy Wall Convuluted PTFE Hose with static-dissipative core, PP Braid												2.1		
	PCWV-FS	PAGE Flare-Seal® PTFE Hose, PP Braid												2.1		
E	PCBV-FS	PAGE Flare-Seal® PTFE Hose with static-dissipative core, PP Braid												2.1		
	RCTW	PAGE Rubber Covered EPDM												3.5		
	RCTB	PAGE Rubber Covered EPDM with static-dissipative core												3.5		
	SBFW	PAGE Page-Flex® SBF											2.1	2.1		
	SBFB	PAGE Page-Flex® SBF with static-dissipative core											2.1	2.1		
	F															

*Z indicates double braid.

Legend

PTFE – Polytetrafluoroethylene

PTFE-S – Polytetrafluoroethylene, Static Dissipative

FEP – Fluorinated Ethylene Propylene

PFA – Perfluoroalkoxy



For detailed ordering information, please consult price list or contact Parflex® Division.

Parker Hannifin Corporation | Parflex® Division | Ravenna, Ohio | parker.com/pfd

www.comoso.com

Construction/Specifications

psi Fluoropolymer Construction and Specifications														Reinforcement Type
3/4	1	1 1/4	1 1/2	2	2-1/2	3	4					Fractional Size		
-12.	-16	-20	-24	-32	-40	-48	-64	Core Tube	Reinforcement Material	Cover Material	Page #	Dash Size		
psi	psi	psi	psi	psi	psi	psi	psi							
								PTFE	SS Wire	—	A-65	PTFE Hose	919	
								PTFE-S	SS Wire	—	A-65	PTFE Hose with static-dissipative core	919B	
								PTFE	SS Wire	S	A-66	Silicone Covered PTFE Hose	919J	
								PTFE	SS Wire	U	A-67	High Abrasion Resistance PTFE Hose	919U	
								PTFE	SS Wire	—	A-68	Heavy Wall PTFE Hose	929	
								PTFE-S	SS Wire	—	A-68	Heavy Wall PTFE Hose with static-dissipative core	929B	
								PTFE-S	SS Wire	S	A-69	Silicone Covered PTFE Hose with static-dissipative core	929BJ	
	7.6	6.9	6.9	5.2	1.7			PTFE	SS Wire	—	A-70	Convoluted PTFE Hose	939	
	7.6	6.9	6.9	5.2	1.7			PTFE-S	SS Wire	—	A-70	Convoluted PTFE Hose with static-dissipative core	939B	
								PTFE-S	SS Wire	—	A-71	High Pressure PTFE Hose with static-dissipative core	943B	
								PTFE-S	SS Wire	—	A-72	High Pressure PTFE Hose with static-dissipative core	944B	
								PTFE-S	SS Wire	—	A-73	High Pressure PTFE Hose with static-dissipative core	950B	
								PTFE-S	SS Wire	—	A-74	High Pressure PTFE Hose with static-dissipative core	955B	
								PTFE	SS Wire	—	A-75	PAGE Ind. PTFE Hose	S30	
								PTFE-S	SS Wire	—	A-75	PAGE Ind. PTFE Hose with static-dissipative core	S30B	
								PTFE	SS Wire	—	A-76	PAGE Ind. Heavy Wall PTFE Hose	S40	
								PTFE-S	SS Wire	—	A-76	PAGE Ind. Heavy Wall PTFE Hose with static-dissipative core	S40B	
	6.9	6.9 8.3*	6.9*	6.2*				PTFE	SS Wire	—	A-77	PAGE Heavy Wall PTFE Hose *Double Braid	STW Z-STW*	
	6.9	6.9 8.3*	6.9*	6.2*				PTFE-S	SS Wire	—	A-77	PAGE Heavy Wall PTFE Hose with static-dissipative core *Double Braid	STB Z-STB*	
	8.3	6.9	5.2	4.5	3.1			PTFE	SS Wire	—	A-82	PAGE Convoluted PTFE Hose	SCW	
	8.3	6.9	5.2	4.5	3.1			PTFE-S	SS Wire	—	A-82	PAGE Convoluted PTFE Hose with static-dissipative core	SCB	
	8.3	6.9	5.2	4.5	3.1	1.4	1.2	1.0	PTFE	SS Wire	—	A-84	PAGE Heavy Wall Convoluted PTFE Hose	SCWV
	8.3	6.9	5.2	4.5	3.1	1.4	1.2	1.0	PTFE-S	SS Wire	—	A-84	PAGE Heavy Wall Convoluted PTFE Hose with static-dissipative core	SCBV
	2.9	2.4	2.2	2.1	1.7	1.4	1.2	1.0	PTFE	SS Wire	—	A-86	PAGE Flare-Seal® PTFE Hose	SCWV-FS
	2.9	2.4	2.2	2.1	1.7	1.4	1.2	1.0	PTFE-S	SS Wire	—	A-86	PAGE Flare-Seal® PTFE Hose with static-dissipative core	SCBV-FS
	1.7	1.7	1.4	1.4	1.4	1.4	1.4	1.4	PTFE	PP	—	A-83	PAGE Convoluted PTFE Hose, PP Braid	PCW
	1.7	1.7	1.4	1.4	1.4	1.4	1.4	1.4	PTFE-S	PP	—	A-83	PAGE Convoluted PTFE Hose with static-dissipative core, PP Braid	PCB
	1.7	1.7	1.4	1.4	1.4	1.0	.86	.69	PTFE	PP	—	A-85	PAGE Heavy Wall Convoluted PTFE Hose, PP Braid	PCWV
	1.7	1.7	1.4	1.4	1.4	1.0	.86	.69	PTFE-S	PP	—	A-85	PAGE Heavy Wall Convoluted PTFE Hose with static-dissipative core, PP Braid	PCBV
	1.7	1.7	1.4	1.4	1.4	1.0	.86	.69	PTFE	PP	—	A-87	PAGE Flare-Seal® PTFE Hose, PP Braid	PCWV-FS
	1.7	1.7	1.4	1.4	1.4	1.0	.86	.69	PTFE-S	PP	—	A-87	PAGE Flare-Seal® PTFE Hose with static-dissipative core, PP Braid	PCBV-FS
	3.5	3.1	2.6	2.6	2.1	1.4	1.4	1.0	FEP	Double Wire Helix	EPDM	A-88	PAGE Rubber Covered EPDM	RCTW
	3.5	3.1	2.6	2.6	2.1	1.4	1.4	1.0	PFA-S	Double Wire Helix	EPDM	A-88	PAGE Rubber Covered EPDM with static-dissipative core	RCTB
	1.7	1.7		1.4					PFA	Bonded Wire-Silicone-Fiber	—	A-78	PAGE Page-Flex® SBF	SBFW
	1.7	1.7		1.4					PFA-S	Bonded Wire-Silicone-Fiber	—	A-78	PAGE Page-Flex® SBF with static-dissipative core	SBFB

PFA-S – Perfluoroalkoxy, Static Dissipative
PP - Polypropylene

S – Silicone
U – Polyurethane

For detailed ordering information, please consult price list or contact Parflex® Division.



Parflex Thermoplastic Hoses

Parflex Thermoplastic Hose Assembly Nomenclature

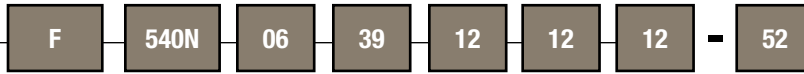

F	Prefix	540N	Hose	06-39	Fitting Configuration*																																									
F	<p>F – Parkrimp (i.e. 55 series)</p> <p>A – Factory Crimp (i.e. 54 series)</p> <p>R – Field Attachable (i.e. 51 series)</p>		<table border="1"> <tr><td>D6/D6R</td><td>53DM</td></tr> <tr><td>H6</td><td>540N</td></tr> <tr><td>R6</td><td>540P</td></tr> <tr><td>HFS</td><td>55LT</td></tr> <tr><td>HFS2</td><td>56DH</td></tr> <tr><td>M8</td><td>575X</td></tr> <tr><td>HTB</td><td>580N</td></tr> <tr><td>HJK</td><td>H580N</td></tr> <tr><td>560</td><td>588N</td></tr> <tr><td>563</td><td>1035A</td></tr> <tr><td>590</td><td>1035HT</td></tr> <tr><td>593</td><td>83FR</td></tr> <tr><td>510A</td><td>B9</td></tr> <tr><td>510C</td><td>5CNG</td></tr> <tr><td>518C</td><td>HLB</td></tr> <tr><td>515H</td><td>MSH</td></tr> <tr><td>520N</td><td>PTH</td></tr> <tr><td>528N</td><td>SLH</td></tr> <tr><td>526BA</td><td></td></tr> <tr><td>527BA</td><td></td></tr> </table>	D6/D6R	53DM	H6	540N	R6	540P	HFS	55LT	HFS2	56DH	M8	575X	HTB	580N	HJK	H580N	560	588N	563	1035A	590	1035HT	593	83FR	510A	B9	510C	5CNG	518C	HLB	515H	MSH	520N	PTH	528N	SLH	526BA		527BA				<p>01 – Male Pipe Thread (with hex) - NPTF</p> <p>02 – Female Pipe Thread - NPT</p> <p>03 – Male SAE (JIC) 37° Flare</p> <p>05 – Male Straight Thread w/ O-Ring</p> <p>06 – Female SAE (JIC) 37° Swivel</p> <p>07 – Female Pipe Swivel</p> <p>13 – Male Pipe Swivel - NPTF</p> <p>37 – Female SAE (JIC) 37° Swivel - 45° Elbow</p> <p>39 – Female SAE (JIC) 37° Swivel - 90° Elbow</p> <p>41 – Female SAE (JIC) 37° Swivel - 90° Long Elbow</p> <p>JC – Female Seal-Lok™ (ORFS) Swivel Short</p> <p>FU – Female JIC/BSP 30° Flare Swivel</p> <p>MU – Metric Female JIC/BSP 30° Flare Swivel</p> <p>J0 – Male Seal-Lok™ (ORFS) Rigid Straight w/O-Ring</p> <p>GU – Female JIC/BSP Parallel Pipe Swive (60° Cone)</p> <p>JS – Female Seal-Lok™ (ORFS) Swivel</p> <p>J7 – Female Seal-Lok™ (ORFS) Swivel - 45° Elbow</p> <p>J9 – Female Seal-Lok™ (ORFS) Swivel - 90° Elbow</p> <p>TU – Universal Tube Stub</p> <p>AL – A-Lok® Compression</p>
D6/D6R	53DM																																													
H6	540N																																													
R6	540P																																													
HFS	55LT																																													
HFS2	56DH																																													
M8	575X																																													
HTB	580N																																													
HJK	H580N																																													
560	588N																																													
563	1035A																																													
590	1035HT																																													
593	83FR																																													
510A	B9																																													
510C	5CNG																																													
518C	HLB																																													
515H	MSH																																													
520N	PTH																																													
528N	SLH																																													
526BA																																														
527BA																																														

* See pg. E-4 for detailed list of available fitting configurations.

12	Connection Size 1	12	Connection Size 2	12	Hose Size	C	Fitting Material
-2	1 1/8	-2	2 1/8	-2	= 1/8	<p>** No Material Designation, Steel</p> <p>C = Stainless Steel</p> <p>B = Brass</p>	
-3	1 3/16	-3	2 3/16	-3	= 3/16		
-4	1 1/4	-4	2 1/4	-4	= 1/4		
-5	1 5/16	-5	2 5/16	-5	= 5/16		
-6	1 3/8	-6	2 3/8	-6	= 3/8		
-8	1 1/2	-8	2 1/2	-8	= 1/2		
-10	1 5/8	-10	2 5/8	-10	= 5/8		
-12	1 3/4	-12	2 3/4	-12	= 3/4		
-16	1 1	-16	2 1	-16	= 1		
-20	1 1-1/4	-20	2 1-1/4				

52	Overall Length	##	Displacement Angle
	Expressed in inches		Specified only if two elbow fittings are used to construct hose assembly.*

NOTE: Face Seal type fittings are measured from sealing face.

*Starting with either end as the far end, measure the angle clockwise to describe the displacement of the near end.

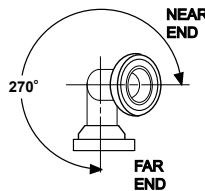

Parflex PTFE Hoses

Parflex PTFE Hose Assembly Nomenclature



P **919** **06** **39** **06** **06** **06** **C** - **30**

P	Prefix	919 Hose		06-39	Fitting Configuration*
		Natural	Static Dissipative		
P – Permanent Crimp (i.e. 91N series) R – Field Attachable (i.e. 90 series) Factory Crimp (i.e. 94 series)		919	919B	06-39	01 – Male Pipe Thread (with hex) - NPTF 02 – Female Pipe Thread - NPT 03 – Male SAE (JIC) 37° Flare 05 – Male Straight Thread w/ O-Ring 07 – Female Pipe Swivel 37 – Female SAE (JIC) 37° Swivel - 45° Elbow 39 – Female SAE (JIC) 37° Swivel - 90° Elbow 41 – Female SAE (JIC) 37° Swivel - 90° Long Elbow JC – Female Seal-Lok™ (ORFS) Swivel Short FU – Female JIC/BSP 30° Flare Swivel MU – Metric Female JIC/BSP 30° Flare Swivel JO – Male Seal-Lok™ (ORFS) Rigid Straight w/O-Ring GU – Female JIC/BSP Parallel Pipe Swive (60° Cone) JS – Female Seal-Lok™ (ORFS) Swivel J7 – Female Seal-Lok™ (ORFS) Swivel - 45° Elbow J9 – Female Seal-Lok™ (ORFS) Swivel - 90° Elbow TU – Universal Tube Stub AL – A-Lok® Compression
		919J	929BJ		
		919U	–		
		929	929B		
		939	939B		
		–	943B		
		–	944B		
		–	950B		
		–	955B		

* See pg. E-4 for detailed list of available fitting configurations.

06	Connection Size 1	06	Connection Size 2	06	Hose Size	C	Fitting Material	30	Overall Length
-2	1 1/8	-2	2 1/8	-2	= 1/8	C = Stainless Steel B = Brass (91N) S = All Steel (91N)	** No Material Designation	30	Expressed in Inches OAL measured from centerline of fitting seat if elbow fittings are used.
-3	1 3/16	-3	2 3/16	-3	= 3/16				
-4	1 1/4	-4	2 1/4	-4	= 1/4				
-5	1 5/16	-5	2 5/16	-5	= 5/16				
-6	1 3/8	-6	2 3/8	-6	= 3/8				
-8	1 1/2	-8	2 1/2	-8	= 1/2				
-10	1 5/8	-10	2 5/8	-10	= 5/8				
-12	1 3/4	-12	2 3/4	-12	= 3/4				
-16	1 1	-16	2 1	-16	= 1				
-20	1 1-1/4	-20	2 1-1/4	-20	= 1-1/4				
-24	1 1-1/2	-24	2 1-1/2	-24	= 1-1/2				
-32	1 2	-32	2 2	-32	= 2				

NOTE: Face Seal type fittings are measured from sealing face.

Displacement Angle
Specified only if two elbow fittings are used to construct hose assembly.*

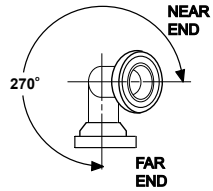

*Starting with either end as the far end, measure the angle clockwise to describe the displacement of the near end.

For detailed ordering information, please consult price list or contact Parflex® Division.

Parker Hannifin Corporation | Parflex® Division | Ravenna, Ohio | parker.com/pfd

www.comoso.com



Parflex PAGE Product Line

PAGE Industrial S30 & S40 Hose Assembly Nomenclature

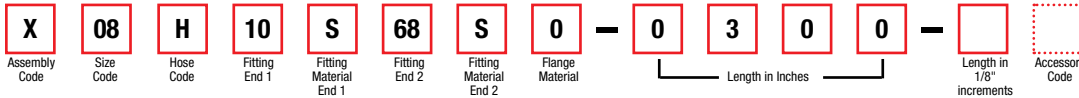

Assembly Code	
Permanently Attached	X
Field Attachable	FA

Size Code	
1/4"	05
5/16"	06
13/32"	08
1/2"	10
5/8"	12
7/8"	16
1-1/8"	20

Hose Code	
S30	S
S30B	SB
S40	H
S40B	HB
ZS40	R
ZS40B	RB
944B	944B
955B	955B

Fitting Code	
Pipe Thread Fittings	
Male Pipe NPT Hex	10
Male Pipe NPT Step Up	15
Male Pipe NPT Step Down	20
Male Union	11
Male Union 45°	14
Male Union 90°	19
Male Union Step Up	16
Male Union Step Down	21
Female Pipe NPT Hex	55
Female Pipe Step Up	58
Female Pipe Step Down	59
Female Union	80
Female Union Step Up	84
Female Union Step Down	88
JIC Fittings	
JIC Female Swivel	68
JIC Female 45° Elbow	66
JIC Female 90° Elbow	67
SAE Female Swivel	69
SAE Female 45° Elbow	70
SAE Female 90° Elbow	71
JIC Female Step Up	64
JIC Female Step Down	65
Tube Stub Fittings	
Tube Stub	91
Tube Stub Step Up	93
Tube Stub Step Down	95
SAE Male Compression	96
Inverted Flare & Power Trim Fittings	
Male Straight	76

Fitting Material	
Stainless (SS)	S
Brass	B
Carbon Steel	C

Accessory Code	
None	
Spring Guard	S
Armour Guard	A
End Bend Restrictors	E
Fire Sleeve	F
Rubber Sleeve	H
FEP Heat Shrink	T
Polyolefin Heat Shrink	P
Silicone Sleeve	M
Internal Spring	I
Vacuum Spring Wire	W
Specials	X

Example: X08H10S68S0-0300

Size: 08 (13/32 I.D.) **Style:** S40

Braid: SS Single Braid

Core: Heavy Wall Smoothbore Convuluted PTFE

End 1: 1/2" 316 SS Male NPT

End 2: 1/2" 316 SS Female 37° Seat JIC Swivel

Length: 300" from end of Male Pipe to seat of Female JIC

NOTE: Length calculations for PAGE hose assemblies are typically made sealing surface to sealing surface per the NAHAD Fluoropolymer Hose Assembly Specification Guidelines unless otherwise requested by customer at time of order.

Parflex PAGE Product Line

“True-Bore” & Convoluted Hose Assembly Nomenclature

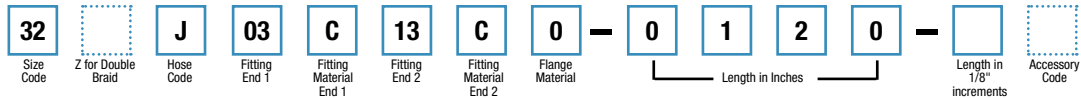
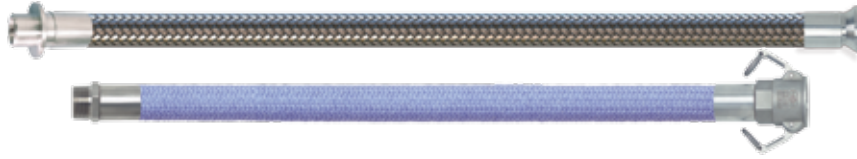

Size Code	
3/16"	03
1/4"	04
5/16"	05
3/8"	06
1/2"	08
5/8"	10
3/4"	12
7/8"	14
1"	16
1-1/4"	20
1-1/2"	24
2"	32
2-1/2"	40
3"	48
4"	64

Hose Code	
ACW	A
CBV	BV
CWV	V
KCB	RB
KCW	R
NCB	MB
NCW	M
PCB	NB
PCBV	PB
PCW	N
PCWV	P
RCTB	GB
RCTW	G
SBFW	SBF
SCB	TB
SCBV	JB
SCW	T
SCWV	J
STB	SB
STW	S

Fitting Code	
Industrial Thread	
Male Pipe NPT Hex	03
Female Pipe NPT Hex	06
Male Pipe NPT Step Down	13
Male Pipe NPT Step Up	23
Male Union Step Up	34
Male Union Step Down	35
JIC Female Swivel	30
Male JIC 37°	31
JIC Female Step Up	32
Male Union	33
Female Union	36
Female NPSH	27
Female ORFS Swivel	80
Male ORFS	81
Male O-Ring Boss	86
Flanges	
Flange Retainer	05
Flare-Seal® Flange Retainer	29
Cam Lock	
Female Cam Lock	07
With Locking Handles	17
Male Cam Lock	08
Sanitary	
Sanitary Tri Clamp	40
Sanitary Tri Clamp 45°	4K
Sanitary Tri Clamp 90°	4L
Sanitary 1-Step Up	4A
Sanitary 2-Step Up	4B
Sanitary 3-Step Up	4C
Sanitary Flare Seal™	4F
Sanitary Mini	42
Sanitary Mini Step Up	43
I-Line Male	48
I-Line Female	49
Bevel Seat Female	45
Bevel Seat Male	46
Tube and Vacuum	
PAGElok™ Tube Adapter	38
PAGElok™ Tube Compression Fitting	39
Special Ends	
Standard Cuffed Ends	90
Non Standard Fitting	99

Fitting Material	
304 Stainless (SS 304)	4
316 Stainless (SS 316)	6
316 Stainless (SS 15Ra) Electropolished to 15Ra	E
Carbon Steel	C
PFA Encapsulated	T
Hastelloy	H
Monel	M

Flange Material	
None	0
Carbon Steel Epoxy Coated	D
304SS	4
316SS	6
Kynar	K
Polypropylene	P
Non Standard	X

Accessory Code	
None	
Spring Guard	S
Armour Guard	A
End Bend Restrictors	E
Fire Sleeve	F
Rubber Sleeve	H
FEP Heat Shrink	T
Polyolefin Heat Shrink	P
Silicone Sleeve	M
Vacuum Spring Wire	W
Specials	X

Example: 32J03C13C0-0120-A
Size: 2" **Style:** SCWV
Braid: 316 SS Single Braid
Core: Heavy Wall Open Pitch Convoluted PTFE
End 1: 2" Male Pipe NPT Hex
End 2: 2" Male Pipe NPT Step Down

Length: 120" from end of Male NPT to end of Male Step Down

NOTE: Length calculations for PAGE hose assemblies are typically made sealing surface to sealing surface per the NAHAD Fluoropolymer Hose Assembly Specification Guidelines unless otherwise requested by customer at time of order.

The part numbering system shows the entire product line offered by the Parker PAGE International business unit. This catalog section only displays a few common hoses. To order items not listed in this catalog, please contact Parker PAGE Customer Service direct at (800) 847-7280 or email pagesales@parker.com.

For detailed ordering information, please consult price list or contact Parflex® Division.

Parker Hannifin Corporation | Parflex® Division | Ravenna, Ohio | parker.com/pfd

www.comoso.com



D6 – Hybrid Hose



Features

- Ideally suited for inventory consolidations to cover all SAE 100R1 pressure and many SAE 100R2 pressure requirements.

Certifications

- Exceeds SAE 100R17
- MSHA Accepted

Applications/Markets



- Medium pressure hydraulic applications
- Agricultural Equipment
- Construction Equipment
- Lubricating Oils
- Transportation

Part Number	Nominal I.D.		Maximum O.D.		Maximum Working Pressure		Minimum Bend Radius		Vac. Rating Hg./73°F	Weight		Permanent Fitting Series
	inch	mm	inch	mm	psi	MPa	inch	mm		lbs./ft.	kg./mtr.	
#												
D604	1/4	6	.51	13	3,000	20.7	2.00	51	28	.12	.18	43**HY***
D606	3/8	10	.67	17	3,000	20.7	2.50	64	28	.19	.28	58/43**/HY***
D608	1/2	13	.82	21	3,000	20.7	3.50	89	28	.29	.43	58/43**/HY***
D610*	5/8	16	1.02	26	3,000	20.7	4.00	102	28	.47	.70	58/HY***
D612*	3/4	19	1.20	30	3,000	20.7	4.80	122	28	.73	1.09	43**/HY***
D616*	1	25	1.50	38	3,000	20.7	6.00	152	28	1.01	1.50	43**/HY***

Construction

Tube: Copolyester
 Reinforcement: One or two braids of high tensile steel wire
 Cover: Smooth synthetic rubber

Operating Parameters

Temperature Range:
 -40°F to +250°F (-40°C to +121°C)
 (Limited to +135°F (+57°C) for synthetic hydraulic fluids and water-based fluids)
 Change in length at working pressure is +2% to -4%
 Min. Burst Pressure is 4x Max. Working Pressure at 73°F (23°C)

Fittings

58 Series – pg. E-12
 43 Series – (**43 Fittings available from Parker Hose Products Division)
 HY Series – pg. E-107 (**HY Fittings available from Parker Hose Products Division)
 For most Parker products, Crimp Die Selection charts can be found online at www.parker.com/crimpsource
 Access instructions are on pg. G-13

Colors

- Black

Notes

*Two wire braid



D6R – Hybrid Hose



Features

- Long continuous package lengths available
- Up to 40% lighter than comparable rubber hoses
- Wide range of fluid compatibility
- Compact hose construction
- Bend radius less than half of conventional SAE 100R1 & 100R2 hoses
- UV resistant cover
- Low force to flex
- 3,000 psi working pressure

Applications/Markets



- Medium pressure hydraulic applications
- Agricultural Equipment
- Construction Equipment
- Lubricating Oils
- Transportation

Certifications

- ISO 11237 Type R17
- SAE 100R17
- MSHA accepted

Part Number	Nominal I.D.		Maximum O.D.		Maximum Working Pressure		Minimum Bend Radius		Weight		Permanent Fitting Series
	inch	mm	inch	mm	psi	MPa	inch	mm	lbs./ft.	kg./m.	
D6R04	1/4	6	.46	12	3,000	21.0	1.5	38	0.10	0.14	55/56
D6R05	5/16	8	.55	14	3,000	21.0	2.25	57	0.14	0.21	55/56
D6R06	3/8	10	.61	16	3,000	21.0	2	51	0.17	0.24	55/56
D6R08	1/2	13	.76	19	3,000	21.0	3	76	0.26	0.37	55/56
D6R10	5/8	16	.96	24	3,000	21.0	3.5	89	0.42	0.62	56
D6R12	3/4	19	1.15	29	3,000	21.0	4.5	114	0.70	1.04	56
D6R16	1	25	1.44	37	3,000	21.0	5.5	140	0.94	1.39	56

Construction

Tube: Copolyester
 Reinforcement: Steel wire
 Cover: Smooth synthetic rubber

Operating Parameters

Temperature Range:

Petroleum base hydraulic fluids and lubricating oils within a temperature range of -40°F to +250°F (-40°C to +121°C)

Synthetic, synthetic blend, water, and water/oil emulsion hydraulic fluids up to hfsr2

Water/glycol hydraulic fluids up to +135°F (+57°C)

Vacuum Rating: 28 inch Hg

Change in Working Length @
 Max. Working Pressure: +2/-4%

Min. Burst Pressure is 4x Max. Working Pressure
 at 73°F (23°C)

Fittings

55 Series – pg. E-12 56 Series – pg. E-36

HY* Series – pg. E-107
 (HY Fittings available from Parker Hose Products Division)

*HY fittings are only approved on an adjustable crimper

For most Parker products, Crimp Die Selection charts can be found online at www.parker.com/crimpsource

Access instructions are on pg. G-13

Color

- Black

Notes

Reference Parflex Safety Guide in Catalog 4660 for complete guidelines on hose selection and maintenance

For detailed ordering information, please consult price list or contact Parflex® Division.

Parker Hannifin Corporation | Parflex® Division | Ravenna, Ohio | parker.com/pfd

www.comoso.com



HFS – Fire-Screen® Hybrid Hose



Features

- Excellent flexibility
- Consistent long-lengths
- Lightweight
- Compact design

Certifications

- Exceeds SAE 100R1
- Marine Applications (SAE J1942 listed)
- MSHA Accepted

Applications/Markets



- Used in high temperature (to +250° F), medium pressure hydraulic applications
- Mobile Equipment
- Machine Tools
- Agricultural Equipment

Part Number	Nominal I.D.		Maximum O.D.		Maximum Working Pressure		Minimum Bend Radius		Vac. Rating Hg./73°F	Weight		Permanent Fitting Series	Field Attachable Series
	inch	mm	inch	mm	psi	MPa	inch	mm		lbs./ft.	kg./mtr.		
#													
HFS04	1/4	6	.51	13	3,000	20.7	2.00	51	28	.12	.18	43*/HY**	BA
HFS05	5/16	8	.59	15	3,000	20.7	2.25	57	28	.17	.25	HY**	–
HFS06	3/8	10	.67	17	2,500	17.2	2.50	64	28	.19	.28	58/43*/HY**	BA
HFS08	1/2	13	.79	20	2,500	17.2	3.50	89	28	.25	.37	58/43*/HY**	BA
HFS12	3/4	19	1.07	27	1,500	10.3	5.00	127	28	.37	.55	43*/HY**	–
HFS16	1	25	1.37	35	1,250	8.6	10.00	254	28	.53	.79	HY**	–

Construction

Tube: Copolyester

Reinforcement: One braid of high tensile steel wire

Cover: Smooth synthetic rubber

Operating Parameters

Temperature Range:

-40°F to +250°F (-40°C to +121°C)

(Limited to +135°F (+57°C) for synthetic hydraulic fluids and water-based fluids)

Change in length at Max. Working Pressure: +2% to -4%

Min. Burst Pressure is 4x Max. Working Pressure at 73°F (23°C)

Fittings

58 Series – pg. E-12

BA Series – pg. E-99

43 Series – (*43 Series Fittings available from Parker Hose Products Division)

HY Series – pg. E-107 (**HY Fittings available from Parker Hose Products Division)

For most Parker products, Crimp Die Selection charts can be found online at www.parker.com/crimpsource

Access instructions are on pg. G-13

Colors

- Black

HFSR Hybrid Hose with Rubber Cover



Features

- Long package lengths typical, up to 500 foot
- Increased oil, ozone and impulse resistance
- Up to 40% lighter than comparable rubber hoses
- UV resistant cover
- Low force to flex
- Low length change under pressure
- Patented process that bonds the core to the reinforcement
 - resists kinking
 - resists core wash out

Applications/Markets



- Industrial
- Material Handling
- Construction
- Waste & Refuse
- Utility Equipment
- Paving and road maintenance

Certifications

- Meets or exceeds SAE J517-100R1
- Meets or exceeds ISO Pressure standards

Part Number	Nominal I.D.		Maximum O.D.		Maximum Working Pressure		Minimum Burst Pressure		Minimum Bend Radius		Weight		Permanent Fitting Series
	inch	mm	inch	mm	psi@73°C	MPa@23°F	psi@73°F	MPa@23°C	inch	mm	lbs./ft.	kg./m.	
#													
HFSR04	1/4	6	.46	12	3,000	20.6	12,000	82.7	1-1/2	38	0.10	0.14	55/56/HY*
HFSR05	5/16	8	.52	13	3,000	20.6	12,000	82.7	1-3/4	45	0.12	0.18	55/56/HY*
HFSR06	3/8	10	.61	16	2,500	17.2	10,000	68.9	2	51	0.17	0.25	55/56/HY*
HFSR08	1/2	13	.74	19	2,500	17.2	10,000	68.9	3	76	0.21	0.32	55/56/HY*
HFSR12	3/4	19	1.02	26	1,500	10.3	6,000	41.3	4-1/4	108	0.31	0.46	55/56/HY*
HFSR16	1	25	1.31	33	1,250	8.6	5,000	34.4	7-1/2	191	0.44	0.66	55/56/HY*

Construction

Tube: Copolyester
 Reinforcement: Steel wire
 Cover: Smooth synthetic rubber

Operating Parameters

Temperature Range:

Petroleum base hydraulic fluids and lubricating oils within a temperature range of -40°F to +250°F (-40°C to +121°C)

Synthetic, synthetic blend, water, and water/oil emulsion hydraulic fluids up to +185°F (+85°C)

Water/glycol hydraulic fluids up to +135°F (+57°C)

Vacuum Rating: 28 inch Hg

Change in length at Max. Working Pressure: +2% to -4%

Min. Burst Pressure is 4x Max. Working Pressure at 73°F (23°C)

Fittings

55 Series - pg. E-12 56 Series - pg. E-36

HY* Series - pg. E-107

*HY fittings are only approved on an adjustable crimper

Crimp information can be found online, for most Parker products, at www.parker.com/crimpsource

HY Series - pg. E-107 (HY Fittings available from Parker Hose Products Division)

For most Parker products, Crimp Die Selection charts can be found online at www.parker.com/crimpsource

Access instructions are on pg. G-13

Color

- Black

Notes

Reference Parflex Safety Guide in Catalog 4660 for complete guidelines on hose selection and maintenance

For detailed ordering information, please consult price list or contact Parflex® Division.

Parker Hannifin Corporation | Parflex® Division | Ravenna, Ohio | parker.com/pfd

www.comoso.com



HFS2 – Fire-Screen II® Hybrid Hose



Features

- Excellent flexibility
- Consistent long-lengths
- Lightweight
- Compact design

Certifications

- Meets/Exceeds SAE 100R2 & 100R16
- Marine Applications (SAE J1942 listed)
- MSHA Accepted

Applications/Markets



- Medium pressure hydraulic applications
- Mobile Equipment
- Machine Tools
- Agricultural Equipment

Part Number	Nominal I.D.		Maximum O.D.		Maximum Working Pressure		Minimum Bend Radius		Vac. Rating Hg./73°F	Weight		Permanent Fitting Series	Field Attachable Series
	inch	mm	inch	mm	psi	MPa	inch	mm		lbs./ft.	kg./mtr.		
#													
HFS204*	1/4	6	.57	14	5,000	34.5	2.00	51	28	.21	.31	43**/HY***	BA
HFS206	3/8	10	.68	17	4,000	27.6	2.50	64	28	.23	.34	58/43**/HY***	BA
HFS208	1/2	13	.82	21	3,500	24.1	3.50	89	28	.29	.43	58/43**/HY***	BA
HFS210	5/8	16	.97	25	2,750	19.0	4.00	102	28	.38	.57	43**/HY***	–
HFS212	3/4	19	1.10	28	2,250	15.5	4.75	121	28	.45	.67	43**/HY***	BA
HFS216*	1	25	1.45	37	2,000	13.8	6.00	152	28	.80	1.19	43**/HY***	BA

Construction

Tube: Copolyester

Reinforcement: One or two braids of high tensile steel wire

Cover: Smooth synthetic rubber

Operating Parameters

Temperature Range:

-40°F to +212°F (-40°C to +100°C)

(Limited to +135°F (+57°C) for synthetic hydraulic fluids and water-based fluids)

Change in length at Max. Working Pressure: +2% to -4%

Min. Burst Pressure is 4x Max. Working Pressure at 73°F (23°C)

Fittings

58 Series – pg. E-12 BA Series – pg. E-99

43 Series – (**43 Series Fittings available from Parker Hose Products Division)

HY Series – pg. E-107 (**HY Fittings available from Parker Hose Products Division) *HY fittings are only approved on an adjustable crimper

For most Parker products, Crimp Die Selection charts can be found online at www.parker.com/crimpsource

Access instructions are on pg. G-13

Colors

- Black

Notes

*Two wire braid

HFS2R – Fire-Screen II® Hybrid Hose



Features

- Excellent flexibility
- Consistent long-lengths
- Lightweight
- Compact design

Certifications

- Meets/Exceeds SAE 100R16
- MSHA Accepted

Applications/Markets



- Medium pressure hydraulic applications
- Mobile Equipment
- Machine Tools
- Agricultural Equipment

Part Number	Nominal I.D.		Maximum O.D.		Maximum Working Pressure		Minimum Bend Radius		Vac. Rating Hg./73°F	Weight		Permanent Fitting Series
	inch	mm	inch	mm	psi	MPa	inch	mm		lbs./ft.	kg./mtr.	
#												
HFS2R04	1/4	6	.54	14	5,000	34.5	2.00	51	28	.21	.31	55/56
HFS2R06	3/8	10	.64	16	4,000	27.6	2.50	64	28	.23	.34	55/56/HY*
HFS2R08	1/2	13	.76	19	3,500	24.1	3.50	89	28	.29	.43	55/56/HY*
HFS2R10	5/8	16	.93	24	2,750	19.0	4.00	102	28	.38	.57	55/56/HY*
HFS2R12	3/4	19	1.07	27	2,250	15.5	4.75	121	28	.45	.67	56/HY*
HFS2R16	1	25	1.40	35	2,000	13.8	6.00	152	28	.80	1.19	56/HY*

Construction

Tube: Copolyester
 Reinforcement: One or two braids of high tensile steel wire
 Cover: Smooth synthetic rubber

Operating Parameters

Temperature Range:
 -40°F to +212°F (-40°C to +100°C)
 (Limited to +185°F (+85°C) for synthetic hydraulic fluids and water-based fluids)
 Change in length at Max. Working Pressure: +2% to -4%
 Min. Burst Pressure is 4x Max. Working Pressure at 73°F (23°C)

Fittings

55 Series – pg. E-12 56 Series – pg. E-36
 HY* Series – pg. E-107
 (HY Fittings available from Parker Hose Products Division)
 *HY fittings are only approved on an adjustable crimper
 For most Parker products, Crimp Die Selection charts can be found online at www.parker.com/crimpsource
 Access instructions are on pg. G-13

Colors

- Black

For detailed ordering information, please consult price list or contact Parflex® Division.

Parker Hannifin Corporation | Parflex® Division | Ravenna, Ohio | parker.com/pfd

www.comoso.com



H6 – High Performance Hydraulic Hose



Features

- Largest temperature range in a medium pressure hydraulic hose
- Low length change capability under pressure
- Ideally suited for inventory consolidations to cover all SAE 100R1 pressure and many SAE 100R2 pressure and abrasion requirements

Certifications

- Exceeds SAE 100R17 Requirements

Applications/Markets



- Medium pressure hydraulic applications
- Over-the-sheave and boom hose applications

Part Number	Nominal I.D.		Maximum O.D.		Maximum Working Pressure		Minimum Bend Radius		Vac. Rating Hg./73°F	Weight		Permanent Fitting Series
	inch	mm	inch	mm	psi	MPa	inch	mm		lbs./ft.	kg./mtr.	
#												
H604	1/4	6	.49	12	3,000	20.7	2.00	51	28	.12	.18	56
H605	5/16	8	.56	14	3,000	20.7	2.25	57	28	.14	.21	HY***
H606	3/8	10	.65	17	3,000	20.7	2.50	64	28	.19	.28	56/43**
H608	1/2	13	.78	20	3,000	20.7	3.50	89	28	.29	.43	56
H610*	5/8	16	1.00	25	3,000	20.7	4.00	102	28	.47	.70	HY***
H612*	3/4	19	1.17	30	3,000	20.7	4.75	121	28	.69	1.03	HY***

Construction

Tube: Copolyester

Reinforcement: One or two braids of high tensile steel wire

Cover: Abrasion-resistant copolymer

Operating Parameters

Temperature Range:

(H604 thru H608) -70°F to +250°F (-57°C to +121°C)

(H610 thru H612) -50°F to +250°F (-45°C to +121°C)

(Limited to +135°F (+57°C) for synthetic hydraulic fluids and water-based fluids)

Change in length at Max. Working Pressure: +2% to -4%

Min. Burst Pressure is 4x Max. Working Pressure at 73°F (23°C)

Fittings

56 Series – pg. E-36

43 Series – (**43 Fittings available from Parker Hose Products Division)

HY Series – pg. E-107 (**HY Fittings available from Parker Hose Products Division)

For most Parker products, Crimp Die Selection charts can be found online at www.parker.com/crimpsource

Access instructions are on pg. G-13

Colors

- Black

Notes

*Two wire braid

Twin line hose available

Preformed assemblies

R6 – Abrasion King® Hose



Features

- Excellent abrasion resistance
- Blue plait provides hose identification

Certifications

- Exceeds SAE 100R17 Requirements

Applications/Markets



- Medium pressure hydraulic applications
- Agricultural Equipment

Part Number	Nominal I.D.		Maximum O.D.		Maximum Working Pressure		Minimum Bend Radius		Vac. Rating Hg./73°F	Weight		Permanent Fitting Series
	inch	mm	inch	mm	psi	MPa	inch	mm		lbs./ft.	kg./mtr.	
#												
R604	1/4	6	.53	13	3000	20.7	2.00	51	28	.11	.16	HY***
R606	3/8	10	.69	18	3000	20.7	2.50	64	28	.20	.30	58/HY***
R608	1/2	13	.84	21	3000	20.7	3.50	89	28	.27	.40	58/HY***
R610*	5/8	16	1.09	28	3000	20.7	4.00	102	28	.51	.76	HY***
R612*	3/4	19	1.24	31	3000	20.7	4.75	121	28	.71	1.06	HY***
R616*	1	25	1.55	39	3000	20.7	6.00	152	28	1.00	1.49	43**

Construction

Tube: Copolyester

Reinforcement: One or two braids of high tensile steel wire

Cover: Abrasion-resistant nylon fabric

Operating Parameters

Temperature Range:

(R604 thru R610) -50°F to +250°F (-46°C to +121°C)

(R612 thru R616) -50°F to +212°F (-45°C to +100°C)

(Limited to +135°F (+57°C) for synthetic hydraulic fluids and water-based fluids)

Change in length at Max. Working Pressure: +2% to -4%

Burst Pressure is 4x Max. Working Pressure at 73°F (23°C)

Fittings

58 Series – pg. E-12

43 Series – (**43 Series Fittings available from Parker Hose Products Division)

HY Series – pg. E-107 (**HY Fittings available from Parker Hose Products Division)

For most Parker products, Crimp Die Selection charts can be found online at www.parker.com/crimpsource

Access instructions are on pg. G-13

Colors

- Black

Notes

*Two wire braid

For detailed ordering information, please consult price list or contact Parflex® Division.

Parker Hannifin Corporation | Parflex® Division | Ravenna, Ohio | parker.com/pfd

www.comoso.com



HTB – Eliminator® Hybrid Hose



Features

- Four-spiral wire hose performance in a high tensile two-wire braid construction
- Excellent flexibility
- Consistent long-lengths

Certifications

- Marine Applications (SAE J1942 listed)
- MSHA Accepted

Applications/Markets



- High-pressure hydraulic applications typically reserved for spiral wire reinforced hoses

Part Number	Nominal I.D.		Maximum O.D.		Maximum Working Pressure		Minimum Bend Radius		Vac. Rating Hg./73°F	Weight		Permanent Fitting Series
	inch	mm	inch	mm	psi	MPa	inch	mm		lbs./ft.	kg./mtr.	
#												
HTB04	1/4	6	.62	16	7,000	48.3	4.00	102	28	.27	.40	HY**
HTB06	3/8	10	.76	19	5,500	37.9	6.00	152	28	.37	.55	43***
HTB08	1/2	13	.90	23	5,000	34.5	7.00	178	28	.46	.68	43***
HTB10	5/8	16	1.03	26	4,000	27.6	8.00	203	28	.52	.77	43***
HTB12	3/4	20	1.20	30	4,000	27.6	9.50	241	28	.73	1.09	43***
HTB16	1	25	1.50	38	3,500	24.1	12.00	305	28	1.01	1.50	43***

Construction

Tube: Copolyester

Reinforcement: Two braids of high tensile steel wire

Cover: Smooth synthetic rubber

Operating Parameters

Temperature Range:

-40°F to +212°F (-40°C to +100°C)

(Limited to +135°F (+57°C) for synthetic hydraulic fluids and water-based fluids)

Change in working length @ Rated WPSI: +2%/-4%

Min. Burst Pressure is 4x Max. Working Pressure at 73°F (23°C)

Fittings

43 Series – (**43 Series Fittings available from Parker Hose Products Division)

HY Series – pg. E-107 (**HY Fittings available from Parker Hose Products Division)

Crimp information can be found online, for most Parker products, at www.parker.com/crimpsource

Access instructions are on pg. G-13

Colors

- Black

Notes

HTB04 cover must be skived prior to fitting attachment

HTBR – Eliminator® Hybrid Hose



Features

- 3500 psi to 7000 psi working pressures
- Wide range of fluid compatibility
- Compact O.D.
- Low force to flex
- UV & Ozone resistant cover
- Low length change under pressure

Certifications

- MSHA Accepted

Applications/Markets



- General Hydraulic Applications
- Lubricating Oils
- Construction Equipment
- Agriculture Equipment

Part Number	Nominal I.D.		Maximum O.D.		Maximum Working Pressure		Minimum Bend Radius		Weight		Permanent Fitting Series
	inch	mm	inch	mm	psi	MPa	inch	mm	lbs./ft.	kg./m.	
#											
HTBR4	1/4	6	.57	14	7,000	48.2	4	102	0.25	0.37	43
HTBR6	3/8	10	.72	18	5,500	37.9	6	152	0.33	0.50	43
HTBR8	1/2	13	.85	21	5,000	34.4	7	178	0.43	0.63	43
HTBR10	5/8	16	1.01	26	4,000	27.5	8	203	0.52	0.77	43
HTBR12	3/4	19	1.16	29	4,000	27.5	9-1/2	241	0.71	1.06	43
HTBR16	1	25	1.43	36	3,500	24.1	12	305	0.91	1.35	43

Construction

Tube: Copolyester

Reinforcement: Two braids of high tensile steel wire

Cover: Smooth synthetic rubber

Operating Parameters

Temperature Range:

-40°F to +212°F (-40°C to +100°C)

Petroleum base hydraulic fluids and lubricating oils within a temperature range -40°F to +212°F (-40°C to +100°C)

Synthetic, synthetic blend, water, and water/oil emulsion hydraulic fluids up to +185°F (+85°C)

Water/glycol hydraulic fluids up to +135°F (+57°C)

Vacuum Rating: 28 inch Hg

Change in length at Max. Working Pressure: +2% to -4%

Min. Burst Pressure is 4x Max. Working Pressure at 73°F (23°C)

Fittings

43 Series - (43 Series Fittings available from Parker Hose Products Division)

For most Parker products, Crimp Die Selection charts can be found online at www.parker.com/crimpsource

Access instructions are on pg. G-13

Colors

- Black

For detailed ordering information, please consult price list or contact Parflex® Division.

Parker Hannifin Corporation | Parflex® Division | Ravenna, Ohio | parker.com/pfd

www.comoso.com



A-31

M8 – E-Z FLEX™ Hybrid Hose



Features

- Four-spiral wire hose performance in a high tensile two-wire braid construction
- Excellent flexibility
- Consistent long-lengths

Certifications

- Meets/Exceeds SAE 100R12
- MSHA Accepted

Applications/Markets



- Medium pressure hydraulic applications
- Agricultural Equipment
- Construction Equipment
- Lubricating Oils
- Transportation

Part Number	Nominal I.D.		Maximum O.D.		Maximum Working Pressure		Minimum Bend Radius		Vac. Rating Hg./73°F	Weight		Permanent Fitting Series
	inch	mm	inch	mm	psi	MPa	inch	mm		lbs./ft.	kg./mtr.	
#												
M806	3/8	10	.76	19	4,000	27.6	2.50	64	28	.37	.55	43*
M808	1/2	13	.90	23	4,000	27.6	3.50	89	28	.46	.68	43*
M810	5/8	16	1.07	27	4,000	27.6	4.00	102	28	.63	.94	43*

Construction

Tube: Copolyester

Reinforcement: Two braids of high tensile steel wire

Cover: Smooth synthetic rubber

Operating Parameters

Temperature Range:

-40°F to +250°F (-40°C to +121°C)

(Limited to +135°F (+57°C) for synthetic hydraulic fluids and water-based fluids)

Change in length at Max. Working Pressure: +2% to -4%

Min. Burst Pressure is 4x Max. Working Pressure at 73°F (23°C)

Fittings

43 Series – (*43 Series Fittings available from Parker Hose Products Division)

For most Parker products, Crimp Die Selection charts can be found online at www.parker.com/crimpsource

Access instructions are on pg. G-13

Colors

- Black

HJK – Highjack® Jackline Hybrid Hose



Features

- 10,000 psi Jack Hose

Certifications

- MSHA Accepted
- Meets I J-100 Requirements

Applications/Markets



- Used for high pressure jackline applications
- Not for high impulse applications

Part Number	Nominal I.D.		Maximum O.D.		Maximum Working Pressure		Minimum Bend Radius		Vac. Rating Hg./73°F	Weight	
	inch	mm	inch	mm	psi	MPa	inch	mm	inch	lbs./ft.	kg./mtr.
HJK04	1/4	6	.62	16	10,000	69	4.0	102	28	.27	.40

Construction

Tube: Copolyester

Reinforcement: Two braids of High Tensile Wire

Cover: Smooth synthetic rubber

Operating Parameters

Temperature Range:

-40°F to +150°F (-40°C to +65°C)

(Limited to +135°F (+57°C) for synthetic hydraulic fluids and water-based fluids)

Change in length at Max. Working Pressure: ±2%

Min. Burst Pressure is 3x Max. Working Pressure at 73°F (23°C)

Fittings

HY Series – pg. E-107 (HY Fittings available from Parker Hose Products Division)

Connection configurations limited to:
-Male Pipe (01)

Colors

- Black

Notes

Factory-made assemblies only

For detailed ordering information, please consult price list or contact Parflex® Division.

Parker Hannifin Corporation | Parflex® Division | Ravenna, Ohio | parker.com/pfd

www.comoso.com



A-33

A
Hose

B
Tubing

C
Coiled Air Hose & Fittings

D
Transportation

E
Fittings

F
Tooling, Equipment & Accessories

G
General Technical

560/560R – General Hydraulic Hose



Features

- Twin or multi-line available. Lighter and smaller than 100R1 with longer lengths
- Fast response hose
- Polyurethane cover for best abrasion resistance

Certifications

- Meets/Exceeds SAE 100R1
- MSHA Accepted

Applications/Markets



- Hydraulic circuits and systems wherever 100R1 hose is specified
- Most synthetic hydraulic fluids, water and wide range of chemicals
- Industrial equipment
- Machine Tools

Part Number	Nominal I.D.		Maximum O.D.		Maximum Working Pressure		Minimum Bend Radius		Vac. Rating Hg./73°F	Weight		Permanent Fitting Series
	inch	mm	inch	mm	psi	MPa	inch	mm		lbs./ft.	kg./mtr.	
#												
560-3	3/16	5	.44	11	3,500	24.1	0.75	19	28	.07	.11	55/56
560-4	1/4	6	.51	13	3,250	22.4	1.75	44	28	.10	.15	55/56
560-5	5/16	8	.58	15	3,000	20.7	2.00	51	28	.12	.19	55/56
560-6	3/8	10	.65	17	2,750	19.0	2.25	57	28	.15	.22	55/56
560-8	1/2	13	.81	21	2,500	17.2	3.25	83	28	.20	.30	55
560R-8	1/2	13	.75	19	2,500	17.2	3.00	76	28	.19	.29	55/56
560-10	5/8	16	.94	24	2,000	13.8	6.00	152	28	.30	.44	55/56
560-12	3/4	19	1.13	29	1,750	12.1	7.00	178	28	.41	.61	58

Construction

Tube: Copolyester
 Reinforcement: High tensile steel wire braid
 Cover: Polyurethane

Operating Parameters

Temperature Range:
 -40°F to +250°F (-40°C to +121°C)
 (Limited to +135°F (+57°C) for synthetic hydraulic fluids and water-based fluids)

Change in length at Max. Working Pressure: ±2%
 Min. Burst Pressure is 4x Max. Working Pressure at 73°F (23°C)

Fittings

55 Series – pg. E-12 56 Series – pg. E-36
 58 Series – pg. E-12

For most Parker products, Crimp Die Selection charts can be found online at www.parker.com/crimpsource
 Access instructions are on pg. G-13

Colors

- Black

Notes

Non-perforated cover

563 – General Hydraulic Hose



Features

- Polyurethane cover for best abrasion resistance

Certifications

- Meets/Exceeds SAE 100R17
- MSHA Accepted

Applications/Markets



- Industrial medium pressure hydraulic hose for use with petroleum, water base and synthetic hydraulic fluids, gases and some solvents and chemical solutions

Part Number	Nominal I.D.		Maximum O.D.		Maximum Working Pressure		Minimum Bend Radius		Vac. Rating Hg./73°F	Weight		Permanent Fitting Series
	inch	mm	inch	mm	psi	MPa	inch	mm		lbs./ft.	kg./mtr.	
#												
563-4	1/4	6	.49	12	3,000	20.7	2.00	51	28	.12	.18	55/HY*
563-6	3/8	10	.65	17	3,000	20.7	2.50	64	28	.19	.28	55/HY*
563-8	1/2	13	.78	20	3,000	20.7	3.50	89	28	.29	.42	55/HY*

Construction

Tube: Copolyester

Reinforcement: High tensile steel wire braid

Cover: Polyurethane

Operating Parameters

Temperature Range:

-40°F to +250°F [212°F for size -8]
(-40°C to +121°C) [100°C for size -8]

(Limited to +135°F (+57°C) for synthetic hydraulic fluids and water-based fluids)

Change in length at Max. Working Pressure: ±2%

Min. Burst Pressure is 4x Max. Working Pressure at 73°F (23°C)

Fittings

55 Series – pg. E-12

HY Series – pg. E-107 (*HY Fittings available from Parker Hose Products Division)

For most Parker products, Crimp Die Selection charts can be found online at www.parker.com/crimpsource

Access instructions are on pg. G-13

Colors

- Black

Notes

Non-perforated cover

For detailed ordering information, please consult price list or contact Parflex® Division.

Parker Hannifin Corporation | Parflex® Division | Ravenna, Ohio | parker.com/pfd

www.comoso.com



A-35

590 – General Hydraulic Hose



Features

- Two wire strength, one wire construction, improved bend radius results
- Twin and multi-line available
- Polyurethane cover for best abrasion resistance

Certifications

- Meets/Exceeds SAE 100R2 / 100R16
- MSHA Accepted
- *ABS Approved - 590-4, 590-6, and 590-8

Applications/Markets



- Construction Equipment
- Machine Tools
- Hydrostatic Transmission
- Refuse Vehicles
- Agriculture Equipment

Part Number	Nominal I.D.		Maximum O.D.		Maximum Working Pressure		Minimum Bend Radius		Vac. Rating Hg./73°F	Weight		Permanent Fitting Series
	#											
	inch	mm	inch	mm	psi	MPa	inch	mm	inch	lbs./ft.	kg./mtr.	
590-3	3/16	5	.44	11	5,000	34.5	1.50	38	28	.10	.15	55
590-4*	1/4	6	.53	13	5,000	34.5	1.75	44	28	.14	.21	55
590-6*	3/8	10	.65	17	4,000	27.6	2.25	57	28	.20	.30	55/56
590-8*	1/2	13	.78	20	3,500	24.1	3.25	82	28	.26	.38	55/56
590-10	5/8	16	.98	25	3,000	20.7	6.00	152	28	.39	.57	56/58
590-12	3/4	19	1.11	28	2,500	17.2	7.00	178	28	.45	.67	58
590-16	1	25	1.43	36	2,000	13.8	8.00	203	28	.59	.88	58

Construction

Tube: Copolyester

Reinforcement: Aramid fiber, high tensile wire braid

Cover: Polyurethane

Operating Parameters

Temperature Range:

-40°F to +250°F (-40°C to +121°C)

(Limited to +135°F (+57°C) for synthetic hydraulic fluids and water-based fluids)

Change in length at Max. Working Pressure: ±2%

Min. Burst Pressure is 4x Max. Working Pressure at 73°F (23°C)

Fittings

55 Series – pg. E-12 56 Series – pg. E-36

58 Series – pg. E-12

For most Parker products, Crimp Die Selection charts can be found online at www.parker.com/crimpsource

Access instructions are on pg. G-13

Colors

- Black

Notes

Non-perforated cover

593 – General Hydraulic Hose



Features

- Works with synthetic hydraulic fluids, water and a range of chemicals
- Two wire strength with one braid flexibility
- Polyurethane cover for best abrasion resistance

Certifications

- Meets/Exceeds SAE 100R2 Pressure Requirements
- MSHA Accepted
- ABS Approved

Applications/Markets



- General Hydraulic Service

Part Number	Nominal I.D.		Maximum O.D.		Maximum Working Pressure		Minimum Bend Radius		Vac. Rating Hg./73°F	Weight		Permanent Fitting Series
	inch	mm	inch	mm	psi	MPa	inch	mm		lbs./ft.	kg./mtr.	
#												
593-12	3/4	20	1.10	28	3000	20.7	7.00	178	28	.47	.70	LV
593-16	1	25	1.45	37	3250	22.4	8.00	203	28	.69	1.02	LV

Construction

Tube: 12 – Copolyester, 16 – Nylon
 Reinforcement: High tensile steel wire braid
 Cover: Polyurethane

Operating Parameters

Temperature Range:
 -40°F to +250°F (-40°C to +121°C)
 (Size -12 only limited to +135°F (+57°C) for synthetic hydraulic fluids and water-based fluids)
 Change in length at Max. Working Pressure: ±2%
 Burst Pressure is 4x Max. Working Pressure at 73°F (23°C)

Fittings

LV Series – pg. E-124
 For most Parker products, Crimp Die Selection charts can be found online at www.parker.com/crimpsource
 Access instructions are on pg. G-13

Colors

- Black

Notes

Non-perforated cover

For detailed ordering information, please consult price list or contact Parflex® Division.

Parker Hannifin Corporation | Parflex® Division | Ravenna, Ohio | parker.com/pfd

www.comoso.com



510A – Refrigerant Hose



Features

- Excellent impulse life
- Compatible with most common hydraulic and refrigeration fluids

Certifications

- Meets/Exceeds SAE 100R7 except -2
- MSHA Accepted except -4, -5, -6

Applications/Markets



- Medium pressure service for both field attachable and permanent fittings
- Used with most common refrigerants

Part Number	Nominal I.D.		Maximum O.D.		Maximum Working Pressure		Minimum Bend Radius		Vac. Rating Hg./73°F	Weight		Permanent Fitting Series	Field Attachable Series
	#	inch	mm	inch	mm	psi	MPa	inch		mm	inch		
510A-2	1/8	3	.34	9	2,500	17.2	0.50	13	28	.03	.05	57	–
510A-3	3/16	5	.43	11	3,000	20.7	2.00	51	28	.05	.07	55/56	51
510A-4	1/4	6	.47	12	2,750	19.0	2.50	64	28	.05	.08	55/56	51
510A-5	5/16	8	.57	14	2,500	17.2	3.00	76	28	.08	.12	55/56	51
510A-6	3/8	10	.64	16	2,250	15.5	4.00	102	28	.08	.13	55/56	51
510A-8	1/2	13	.81	21	2,000	13.8	5.50	140	28	.13	.20	55/56	51
510A-12	3/4	19	1.10	28	1,250	8.6	7.50	191	28	.19	.29	–	51
510A-16	1	25	1.40	36	1,000	6.9	10.00	254	28	.28	.41	–	51

Construction

Tube: Proprietary nylon blend
 Reinforcement: Fiber
 Cover: Polyurethane

Operating Parameters

Temperature Range:
 -40°F to +212°F (-40°C to +100°C)
 Change in length at Max. Working Pressure: ±3%
 Min. Burst Pressure is 4x Max. Working Pressure at 73°F (23°C)

Fittings

51 Series – pg. E-5 55 Series – pg. E-12
 56 Series – pg. E-36 57 Series – pg. E-58

For most Parker products, Crimp Die Selection charts can be found online at www.parker.com/crimpsource
 Access instructions are on pg. G-13

Colors

- Black

Notes

Perforated cover
 51 Series field attachable couplings are not intended for use on hose that has previously been in service

510C – General Hydraulic Hose



Features

- Superior abrasion resistance
- Extreme flexibility
- Medium pressure service for permanent and field attachable fittings

Certifications

- Meets/Exceeds SAE 100R7 except -2
- MSHA Accepted except -4

Applications/Markets



- Medium pressure service for both field attachable and permanent fittings
- Used with most common refrigerants

Part Number	Nominal I.D.		Maximum O.D.		Maximum Working Pressure		Minimum Bend Radius		Vac. Rating Hg./73°F	Weight		Permanent Fitting Series	Field Attachable Series
	inch	mm	inch	mm	psi	MPa	inch	mm		lbs./ft.	kg./mtr.		
#													
510C-2	1/8	3	.34	9	2,500	17.2	0.50	13	28	.03	.05	57	–
510C-3*	3/16	5	.43	11	3,250	22.4	0.75	19	28	.05	.07	55/56	51
510C-4*	1/4	6	.47	12	3,000	20.7	1.50	38	28	.05	.08	55/56	51
510C-5	5/16	8	.57	14	2,500	17.2	1.75	44	28	.08	.11	55/56	51
510C-6	3/8	10	.64	16	2,250	15.5	2.00	51	28	.10	.14	55/56	51
510C-8	1/2	13	.81	21	2,250	15.5	3.00	76	28	.15	.22	55/56	51
510C-12	3/4	19	1.09	28	1,250	8.6	5.00	127	28	.21	.31	55/56	51
510C-16	1	25	1.32	34	1,000	6.9	8.00	203	28	.27	.40	55/56	51

Construction

Tube: Copolyester
 Reinforcement: Fiber
 Cover: Proprietary Blend (PFX)

Operating Parameters

Temperature Range:
 -40°F to +212°F (-40°C to +100°C)
 (Limited to +135°F (+57°C) for synthetic hydraulic fluids and water-based fluids)

Change in length at Max. Working Pressure: ±2%
 Min. Burst Pressure is 4x Max. Working Pressure at 73°F (23°C)

Fittings

51 Series – pg. E-5 55 Series – pg. E-12
 56 Series – pg. E-36 57 Series – pg. E-58

For most Parker products, Crimp Die Selection charts can be found online at www.parker.com/crimpsource
 Access instructions are on pg. G-13

Colors

- Black

Notes

Perforated cover
 *3/16" and 1/4" working pressure reduced to 3,000 and 2,750 psi respectively when using field attachable couplings
 51 Series field attachable couplings are not intended for use on hose that has previously been in service

For detailed ordering information, please consult price list or contact Parflex® Division.

Parker Hannifin Corporation | Parflex® Division | Ravenna, Ohio | parker.com/pfd

www.comoso.com



518C – Non-Conductive Hose



Features

- Twin or multi-line constructions available
- High density braid for maximum impulse life without loss of flexibility

Certifications

- Meets SAE J517 for less than 50 micro-amps leakage under 75,000 volts per ft.
- Meets/Exceeds SAE 100R7 specifications and Electrical Standards except 518C-2 with respect to maximum working pressure
- ANSI A92.2

Applications/Markets



- Medium pressure hydraulic service where both field attachable and permanent hydraulic circuit exposure and contact with high voltage may be encountered

Part Number	Nominal I.D.		Maximum O.D.		ANSI A92.2 Max. Working Pressure		SAE 100R7 Max. Working Pressure		Minimum Bend Radius		Vac. Rating Hg./73°F	Weight		Permanent Fitting Series	Field Attachable Series
	inch	mm	inch	mm	psi	MPa	psi	MPa	inch	mm		lbs./ft.	kg./mtr.		
#															
518C-2	1/8	3	.34	9	3,150	21.7	2,500	17.2	0.50	13	28	.03	.05	57	–
518C-3*	3/16	5	.43	11	3,250	22.4	3,250	20.7	0.75	19	28	.05	.07	55/56	51
518C-4*	1/4	6	.47	12	3,150	21.7	3,000	19.0	1.50	38	28	.05	.08	55/56	51
518C-5	5/16	8	.57	14	3,150	21.7	2,500	17.2	1.75	44	28	.08	.11	55/56	51
518C-6	3/8	10	.64	16	3,000	20.7	2,250	15.5	2.00	51	28	.10	.14	55/56	51
518C-8	1/2	13	.81	21	3,000	20.7	2,250	15.5	3.00	76	28	.15	.22	55/56	51
518C-12	3/4	19	1.09	28	1,660	11.5	1,250	8.6	5.00	127	28	.21	.31	55/56	51
518C-16	1	25	1.32	34	1,330	9.2	1,000	6.9	8.00	203	28	.27	.40	55/56	51

Construction

Tube: Copolyester

Reinforcement: Fiber

Cover: Proprietary Blend (PFX)

Operating Parameters

Temperature Range:

-40°F to +212°F (-40°C to +100°C)

(Limited to +135°F (+57°C) for synthetic hydraulic fluids and water-based fluids)

Change in length at Max. Working Pressure: ±2%

Min. Burst Pressure:

4:1 Design Factor is required if hose failure will result in movement of aerial device

3:1 Design Factor is acceptable if hose failure will not result in movement of aerial device

SAE requires 4:1 Design Factor

Colors

- Orange

Fittings

51 Series – pg. E-5 55 Series – pg. E-12

56 Series – pg. E-36 57 Series – pg. E-58

For most Parker products, Crimp Die Selection charts can be found online at www.parker.com/crimpsource

Access instructions are on pg. G-13

Notes

Non-perforated cover

Lay lines on this hose will have both ANSI and SAE maximum working pressure listed. ANSI A92.2 “Vehicle Mounted Elevating and Rotating Aerial Devices”

*3/16” and 1/4” working pressure reduced to 3,000 and 2,750 psi respectively when using field attachable couplings

51 Series field attachable couplings are not intended for use on hose that has previously been in service



For detailed ordering information, please consult price list or contact Parflex® Division.

518D – Non-Conductive Hose



Features

- Nylon core for maximum resistance to permeable fluids.
- Heavier cover for super high abrasion resistance. (518D-4)
- Heavier cover makes splitting bonded hose easier. (518D-4)
- Super high density braid allows smaller braid O.D. (518D-4)
- Twin or multi-line constructions available.

Certifications

- Meets SAE J517 for less than 50 micro-amps leakage under 75,000 volts per ft.
- Meets/Exceeds SAE 100R7 specifications
- ANSI A92.2

Applications/Markets



- Medium pressure hydraulic service
- Aerial Lift

Part Number	Nominal I.D.		Maximum O.D.		ANSI A92.2 Max. Working Pressure 73°F/ 23°C		SAE 100R7 Max. Working Pressure 73°F/ 23°C		Minimum Bend Radius		Vac. Rating Hg./73°F	Weight		Permanent Fitting Series
	inch	mm	inch	mm	psi	MPa	psi	MPa	inch	mm	inch	lbs./ft.	kg./mtr.	
#														
518D-2	1/8	3	.34	9	3,150	21.7	3,000	20.7	0.50	13	28	.03	.05	57
518D-3	3/16	5	.43	11	3,250	22.4	3,250	22.4	0.75	19	28	.05	.07	55/56
518D-4	1/4	6	.47	12	3,150	21.7	3,000	20.7	1.50	38	28	.06	.09	55/56
518D-5	5/16	8	.57	14	3,150	21.7	2,500	17.2	1.75	44	28	.08	.11	55/56
518D-6	3/8	10	.64	16	3,000	20.7	2,250	15.5	2.00	51	28	.10	.14	55/56
518D-8	1/2	13	.81	21	3,000	20.7	2,250	15.5	3.00	76	28	.15	.22	55/56
518D-12	3/4	19	1.09	28	1,660	11.5	1,250	8.6	5.00	127	28	.21	.31	55

Construction

Tube: Nylon

Reinforcement: High Strength Synthetic Fiber

Cover: Proprietary Blend (PFX)

Operating Parameters

Temperature Range:

-40°F to +212°F (-40°C to +100°C)

Change in length at Max. Working Pressure: ±2%

Min. Burst Pressure:

4:1 Design Factor is required if hose failure will result in movement of aerial device

3:1 Design Factor is acceptable if hose failure will not result in movement of aerial device

SAE requires 4:1 Design Factor

Colors

- Orange

Fittings

55 Series – pg. E-12 56 Series – pg. E-36

57 Series – pg. E-58 58 Series – pg. E-12

For most Parker products, Crimp Die Selection charts can be found online at www.parker.com/crimpsource

Access instructions are on pg. G-13

Notes

Non-perforated cover

Lay lines on this hose will have both ANSI and SAE maximum working pressure listed. ANSI A92.2 “Vehicle Mounted Elevating and Rotating Aerial Devices”

For detailed ordering information, please consult price list or contact Parflex® Division.

Parker Hannifin Corporation | Parflex® Division | Ravenna, Ohio | parker.com/pfd

www.comoso.com



515H – Compact/Light Weight Hose



Features

- Twin or multi-line available
- Compact OD, light weight, flexible
- Special order colors for system color coding

Certifications

- MSHA Accepted

Applications/Markets



- Hydraulic and pneumatic systems where a small O.D. hose is necessary
- Pilot Lines
- Joystick Controls

Part Number	Nominal I.D.		Maximum O.D.		Maximum Working Pressure		Minimum Bend Radius		Vac. Rating Hg./73°F	Weight		Permanent Fitting Series
	#											
	inch	mm	inch	mm	psi	MPa	inch	mm	inch	lbs./ft.	kg./mtr.	
515H-3*	3/16	5	.34	9	2,175	15.0	0.75	19	28	.03	.04	54
515H-4	1/4	6	.41	10	2,000	13.8	1.50	38	28	.04	.05	54
515H-5*	5/16	8	.49	12	1,750	12.0	1.75	44	28	.05	.07	54
515H-6	3/8	10	.56	14	1,500	10.3	2.00	51	28	.05	.08	54
515H-8*	1/2	13	.71	18	1,500	10.3	3.00	76	28	.11	.16	54

Construction

Tube: Copolyester
 Reinforcement: Fiber
 Cover: Polyurethane

Operating Parameters

Temperature Range:

-40°F to +212°F (-40°C to +100°C)

(Limited to +135°F (+57°C) for synthetic hydraulic fluids and water-based fluids)

Change in length at Max. Working Pressure: ±2%

Min. Burst Pressure is 4x Max. Working Pressure at 73°F (23°C)

Fittings

54 Series – pg. E-8

For most Parker products, Crimp Die Selection charts can be found online at www.parker.com/crimpsource

Access instructions are on pg. G-13

Colors

- Black

Notes

*Factory-made assemblies only -3, -5 and -8

Approved with rapid assembly fitting system
 Perforated cover

520N/528N – General Hydraulic Hose



Features

- Twin and multi-line available
- Fast response, lighter and smaller O.D. than 100R2 hose

Certifications

- Meets/Exceeds SAE 100R8
- 520N MSHA Accepted
- 528N Meets SAE J517 for less than 50 micro-amps leakage under 75,000 volts per foot

Applications/Markets



- Hydraulic and pneumatic circuits and systems
- Ideal in hot water applications
- Not suggested for use in over-the-sheave (pulley system) applications

Part Number		Nominal I.D.		Maximum O.D.		Maximum Working Pressure		Minimum Bend Radius		Vac. Rating Hg./73°F	Weight		Permanent Fitting Series
#	#												
Natural	Non-Conductive	inch	mm	inch	mm	psi	MPa	inch	mm	inch	lbs./ft.	kg./mtr.	
520N-3	528N-3	3/16	5	.43	11	5,000	34.5	1.50	38	28	.05	.07	55/56
520N-4	528N-4	1/4	6	.51	13	5,000	34.5	2.00	51	28	.07	.10	55/56
520N-5	528N-5	5/16	8	.57	14	4,500	31.0	2.50	64	28	.08	.12	55/56
520N-6	528N-6	3/8	10	.65	17	4,000	27.6	2.50	64	28	.08	.13	55/56
520N-8	528N-8	1/2	13	.81	21	3,500	24.1	4.00	102	28	.14	.20	55/56
520N-10	528N-10	5/8	16	.92	23	2,750	19.0	6.00	152	28	.17	.25	55

Construction

Tube: Nylon
 Reinforcement: Aramid fiber
 Cover: Polyurethane

Operating Parameters

Temperature Range:
 -40°F to +212°F (-40°C to +100°C)
 Change in length at Max. Working Pressure: ±2%
 Min. Burst Pressure is 4x Max. Working Pressure at 73°F (23°C)

Fittings

55 Series – pg. E-12 56 Series – pg. E-36

For most Parker products, Crimp Die Selection charts can be found online at www.parker.com/crimpsource

Access instructions are on pg. G-13

Colors

- Black
- Orange (Non-Conductive)

Notes

Perforated cover - 520N
 Non-perforated cover - 528N

For detailed ordering information, please consult price list or contact Parflex® Division.

Parker Hannifin Corporation | Parflex® Division | Ravenna, Ohio | parker.com/pfd

www.comoso.com



526BA – Breathing Air Refill Hose



Features

- 6000 psi Constant Pressure

Certifications (Complies with:)

- CGA G7.1-1 Grade E Breathing Air Standards
- NFPA 1901

Applications/Markets



- Integrated containment fill stations
- Mobile and stationary systems with or without cascade controls



- Mobile Trailer/Truck Systems
- Portable SCBA Fill

Part Number	Nominal I.D.		Maximum O.D.		Maximum Working Pressure		Minimum Bend Radius		Vac. Rating Hg./73°F	Weight		Permanent Fitting Series
	inch	mm	inch	mm	psi	MPa	inch	mm		lbs./ft.	kg./mtr.	
#												
526BA-3	3/16	5	.42	11	6,000	41.4	1.50	38	28	.05	.07	55
526BA-4	1/4	6	.50	13	6,000	41.4	2.00	51	28	.07	.10	55
526BA-6	3/8	10	.64	16	6,000	41.4	3.00	76	28	.09	.13	55

Construction

Tube: Nylon

Reinforcement: Aramid fiber

Cover: Polyurethane

Operating Parameters

Temperature Range:

-40°F to +180°F (-40°C to +82°C)

Change in length at Max. Working Pressure: ±2%

Min. Burst Pressure is 4x Max. Working Pressure at 73°F (23°C)

Fittings

55 Series – pg. E-12

For most Parker products, Crimp Die Selection charts can be found online at www.parker.com/crimpsource

Access instructions are on pg. G-13

Colors

- Gray

Notes

Perforated cover

Not for use as part of a SCBA systems

This hose is not for use between a pressure reducing regulator and breathing mask

For fitting attachment lubricate only with water or non-toxic lubricant. Do not assemble with petroleum or hydrocarbon based lubricants. Do not flush with solvents of any kind

This hose does not contain a conductive element; therefore, it should not be used with explosive gases such as pure oxygen and hydrogen

Hose is compliant with CGA Grade E Breathing Air Standards, however air quality is dependent upon all system components

527BA – Breathing Air Refill Hose



Features

- 7000 psi constant pressure

Certifications (Complies with:)

- CGA G7.1-1 Grade E Breathing Air Standards
- NFPA 1901

Applications/Markets



- Integrated containment fill stations
- Mobile and stationary systems with or without cascade controls



- Mobile Trailer/Truck Systems
- Portable SCBA Fill

Part Number	Nominal I.D.		Maximum O.D.		Maximum Working Pressure		Minimum Bend Radius		Vac. Rating Hg./73°F	Weight		Permanent Fitting Series
	inch	mm	inch	mm	psi	MPa	inch	mm		lbs./ft.	kg./mtr.	
#												
527BA-3	3/16	5	.43	11	7,000	48.3	1.50	38	28	.05	.07	55
527BA-4	1/4	6	.52	13	7,000	48.3	2.00	51	28	.07	.11	55

Construction

Tube: Nylon

Reinforcement: Aramid fiber

Cover: Polyurethane

Operating Parameters

Temperature Range:

-40°F to +180°F (-40°C to +82°C)

Change in length at Max. Working Pressure: ±2%

Min. Burst Pressure is 4x Max. Working Pressure at 73°F (23°C)

Fittings

55 Series – pg. E-12

Connection configurations limited to:

- Male Pipe (01)
- Female Pipe (02)
- Male JIC (03, 3E)
- Female JIC Swivel (06, 37, 39, 41, L9)

For most Parker products, Crimp Die Selection charts can be found online at www.parker.com/crimpsource

Access instructions are on pg. G-13

Colors

- Blue

Notes

Perforated cover

Not for use as part of a SCBA systems

This hose is not for use between a pressure reducing regulator and breathing mask

For fitting attachment lubricate only with water or non-toxic lubricant. Do not assemble with petroleum or hydrocarbon based lubricants. Do not flush with solvents of any kind

This hose does not contain a conductive element; therefore, it should not be used with explosive gases such as pure oxygen and hydrogen

Hose is compliant with CGA Grade E Breathing Air Standards, however air quality is dependent upon all system components

For detailed ordering information, please consult price list or contact Parflex® Division.

Parker Hannifin Corporation | Parflex® Division | Ravenna, Ohio | parker.com/pfd

www.comoso.com



A-45

Hose
A

Tubing
B

Coiled Air Hose
& Fittings
C

Transportation
D

Fittings
E

Tooling, Equipment
& Accessories
F

General Technical
G

53DM/538DM – DuraMax™ Low Temperature



Features

- Matte cover for low coefficient of friction
- Superior flexibility in cold temperature applications
- Better bend radius than SAE J517 and 100R7
- Smaller O.D.s than 100R7 and 100R18
- 3000 psi constant pressure

Certifications

- Meets/Exceeds SAE 100R18
- 538DM Meets SAE J517 for less than 50 micro-amps leakage under 75,000 volts per foot

Applications/Markets



- Excellent over-the-sheave in lift truck applications
- Cold storage or refrigerated areas
- Construction and agriculture equipment in cold climates

Part Number		Nominal I.D.		Maximum O.D.		Maximum Working Pressure		Minimum Bend Radius		Vac. Rating Hg./73°F	Weight		Permanent Fitting Series
#	#												
Natural	Non-Conductive	inch	mm	inch	mm	psi	MPa	inch	mm	inch	lbs./ft.	kg./mtr.	
53DM-3	538DM-3	3/16	5	.43	11	3,000	20.7	1.00	25	28	.06	.08	55/56
53DM-4	538DM-4	1/4	6	.49	12	3,000	20.7	1.25	32	28	.07	.10	55/56
53DM-5	538DM-5	5/16	8	.60	15	3,000	20.7	2.00	51	28	.10	.15	58/HY*
53DM-6	538DM-6	3/8	10	.66	17	3,000	20.7	2.00	51	28	.11	.16	55/56
53DM-8	538DM-8	1/2	13	.84	21	3,000	20.7	3.50	89	28	.17	.26	55/56
53DM-10	538DM-10	5/8	16	1.03	26	3,000	20.7	4.00	102	28	.22	.33	58
53DM-12	-	3/4	19	1.13	29	3,000	20.7	6.50	165	28	.26	.39	58H

Construction

Tube: Copolyester
Reinforcement: Fiber
Cover: Copolyester

Operating Parameters

Temperature Range:

-70°F to +212°F (-57°C to +100°C)

For use with water and water-based hydraulic fluids to +135°F (+57°C)

Change in length at Max. Working Pressure: ±2%

Min. Burst Pressure is 4x Max. Working Pressure at 73°F (23°C)

Fittings

55 Series – pg. E-12 56 Series – pg. E-36

58 Series – pg. E-12 58H Series – pg. E-61

HY Series – pg. E-107 (*HY Fittings available from Parker Hose Products Division)

For most Parker products, Crimp Die Selection charts can be found online at www.parker.com/crimpsource

Access instructions are on pg. G-13

Colors

- Black
- Orange (Non-Conductive)

Notes

Do not use in over-the-sheave applications

Perforated cover - 53DM

Non-perforated cover - 538DM



For detailed ordering information, please consult price list or contact Parflex® Division.

Parker Hannifin Corporation | Parflex® Division | Ravenna, Ohio | parker.com/pfd

www.comoso.com

540N – General Hydraulic Hose



Features

- Matte cover for low coefficient of friction
- Special order colors
- Twin or multi-line available
- Excellent chemical compatibility
- Greater range of fluid compatibility than SAE 100R1 hose

Certifications

- Meets/Exceeds SAE 100R7
- MSHA Accepted

Applications/Markets



- Hydraulic and pneumatic systems
- Agricultural Spraying
- Polyurethane Foam Mixers
- Fire-resistant Fluid
- Hot Water

Part Number	Nominal I.D.		Maximum O.D.		Maximum Working Pressure		Minimum Bend Radius		Vac. Rating Hg./73°F	Weight		Permanent Fitting Series
	inch	mm	inch	mm	psi	MPa	inch	mm		lbs./ft.	kg./mtr.	
#												
540N-2	1/8	3	.34	9	3,000	20.7	0.50	13	28	.03	.05	57
540N-3	3/16	5	.44	11	3,000	20.7	0.75	19	28	.04	.06	55/56
540N-4	1/4	6	.50	13	2,750	19.0	1.50	38	28	.07	.10	55/56
540N-5	5/16	8	.58	15	2,500	17.2	1.75	44	28	.07	.10	55/56
540N-6	3/8	10	.65	17	2,250	15.5	2.00	51	28	.09	.13	55/56
540N-8	1/2	13	.81	21	2,000	13.8	3.00	76	28	.13	.19	55/56
540N-12	3/4	19	1.05	27	1,250	8.6	6.00	152	28	.17	.25	55/56

Construction

Tube: Nylon
 Reinforcement: Fiber
 Cover: Polyurethane

Operating Parameters

Temperature Range:
 -40°F to +212°F (-40°C to +100°C)
 Change in length at Max. Working Pressure: ±2%
 Min. Burst Pressure is 4x Max. Working Pressure at 73°F (23°C)

Fittings

55 Series – pg. E-12 56 Series – pg. E-36
 57 Series – pg. E-58

For most Parker products, Crimp Die Selection charts can be found online at www.parker.com/crimpsource
 Access instructions are on pg. G-13

Colors

- Black

Notes

Perforated cover

For detailed ordering information, please consult price list or contact Parflex® Division.

Parker Hannifin Corporation | Parflex® Division | Ravenna, Ohio | parker.com/pfd

www.comoso.com



540P – Specialty Water Hose



Features

- Plasticizer free non-leaching core tube
- Low-moisture permeability

Certifications

- Meets/Exceeds SAE 100R7
- Core tube compliant with FDA Title 21

Applications/Markets



- Potable water delivery to remote sites
- Distilled and de-ionized water

Part Number	Nominal I.D.		Maximum O.D.		Maximum Working Pressure		Minimum Bend Radius		Vac. Rating Hg./73°F	Weight		Permanent Fitting Series
	inch	mm	inch	mm	psi	MPa	inch	mm		inch	lbs./ft.	
#												
540P-4	1/4	6	.50	13	2,750	19.0	1.25	32	28	.05	.08	55/56
540P-6	3/8	10	.65	17	2,250	15.5	2.00	51	28	.09	.13	55/56
540P-8	1/2	13	.81	21	2,000	13.8	3.00	76	28	.13	.19	55/56
540P-12	3/4	19	1.05	27	1,250	8.6	5.00	127	28	.19	.28	55/56

Construction

Tube: Polyethylene
 Reinforcement: Fiber
 Cover: Polyurethane

Operating Parameters

Temperature Range:
 -40°F to +150°F (-40°C to +66°C)
 Change in length at Max. Working Pressure: ±2%
 Min. Burst Pressure is 4x Max. Working Pressure at 73°F (23°C)

Fittings

55 Series – pg. E-12 56 Series – pg. E-36
 For most Parker products, Crimp Die Selection charts can be found online at www.parker.com/crimpsource
 Access instructions are on pg. G-13

Colors

- Aqua

Notes

Perforated cover

55LT – Low Temperature Hose



Features

- Twin and multi-line available
- Superior flexibility in cold temperature applications

Certifications

- Meets/Exceeds SAE 100R7

Applications/Markets



- Hydraulic systems exposed to very low temperatures
- Excellent over-the-sheave in lift truck applications
- Cold storage or refrigerated areas
- Construction and agriculture equipment in cold climates

Part Number	Nominal I.D.		Maximum O.D.		Maximum Working Pressure		Minimum Bend Radius		Vac. Rating Hg./73°F	Weight		Permanent Fitting Series
	#	inch	mm	inch	mm	psi	MPa	inch		mm	inch	
55LT-2	1/8	3	.34	9	3,000	20.7	0.50	13	28	.03	.05	57
55LT-3	3/16	5	.43	11	3,250	22.4	0.75	19	28	.05	.08	55/56
55LT-4	1/4	6	.51	13	3,000	20.7	1.25	32	28	.07	.10	55/56
55LT-5	5/16	8	.57	14	2,500	17.2	1.75	44	28	.09	.13	55/56
55LT-6	3/8	10	.66	17	2,250	15.5	2.00	51	28	.10	.14	55/56
55LT-8	1/2	13	.81	21	2,000	13.8	3.00	76	28	.14	.21	55/56
55LT-12	3/4	19	1.09	28	1,250	8.6	5.00	127	28	.21	.31	55

Construction

Tube: Copolyester
 Reinforcement: Fiber
 Cover: Copolyester

Operating Parameters

Temperature Range:

-70°F to +212°F (-57°C to +100°C)

For use with water and water-based hydraulic fluids to +135°F (+57°C)

Change in length at Max. Working Pressure: ±2%

Min. Burst Pressure is 4x Max. Working Pressure at 73°F (23°C)

Fittings

55 Series – pg. E-12 56 Series – pg. E-36

57 Series – pg. E-58

For most Parker products, Crimp Die Selection charts can be found online at www.parker.com/crimpsource

Access instructions are on pg. G-13

Colors

- Black

Notes

Perforated cover

For detailed ordering information, please consult price list or contact Parflex® Division.

Parker Hannifin Corporation | Parflex® Division | Ravenna, Ohio | parker.com/pfd

www.comoso.com



56DH/568DH – Diagnostic Hose



Features

- Twin or multi-line available
- Compact O.D.
- Light weight
- Flexible

Certifications

- MSHA Accepted for -2 only

Applications/Markets



- Hydraulic and pneumatic systems where a small O.D. hose is necessary
- Diagnostic hydraulic lines

Part Number		Nominal I.D.		Maximum O.D.		Maximum Working Pressure		Minimum Bend Radius		Weight		Permanent Fitting Series
#	#	⊙		⊙		↗		↘		lbs	kg	⊗
Natural	Non-Conductive	inch	mm	inch	mm	psi	MPa	inch	mm	lbs./ft.	kg./mtr.	
56DH-1.5	568DH-1.5	.09	2	.20	5	6,000	41.4	0.25	6	.02	.01	SF
56DH-2	568DH-2	.14	4	.32	8	6,000	41.4	0.50	13	.03	.05	CY

Construction

Tube: Nylon

Reinforcement: Aramid fiber

Cover: Polyurethane

Operating Parameters

Temperature Range:

-40°F to +200°F (-40°C to +93°C)

Change in length at Max. Working Pressure: ±2%

Min. Burst Pressure is 4x Max. Working Pressure at 73°F (23°C)

Fittings

CY Series – pg. E-101

SF Series – pg. E-105

For most Parker products, Crimp Die Selection charts can be found online at www.parker.com/crimpsource

Access instructions are on pg. G-13

Colors

● Black

● Orange (Non-Conductive)

Notes

Perforated cover - 56DH

Non-perforated cover - 568DH

569 High Pressure Hydraulic Hose



Features

- 10,000 psi working pressure
- Lightweight aramid fiber construction
- (20-45% lighter than comparable hoses)
- Bonded construction available
- Compact O.D. for improved routing and handling
- Excellent kink resistance

Certifications

- IJ-100 Requirements

Applications/Markets



- Hydraulic tools
- High pressure hydraulics
- High pressure pumps
- Jacking systems
- Emerging markets (Oil & Gas)

Part Number	Nominal I.D.		Maximum O.D.		Maximum Working Pressure		Minimum Bend Radius		Weight	
	inch	mm	inch	mm	psi@73°F	MPa@23°F	inch	mm	lbs./ft.	kg./m.
569-4	1/4	6	.54	14	10,000	69.0	2	51	.08	.122

Construction

Tube: Nylon
 Reinforcement: Aramid fiber
 Cover: Polyurethane

Operating Parameters

Temperature Range:
 -40°F to +176°F (-40°C to +80°C)
 Vacuum Rating: 28 inch Hg
 Change in length at Max. Working Pressure: ±2%
 Min. Burst Pressure is 4x Max. Working Pressure at 73°F (23°C)

Fittings

58 Series – pg. E-12
 Connection configurations limited to:

- Male Taper Pipe Rigid Straight (10158-4-4, 10158-6-4)
- Metric Swivel Female DIN 20078 Light Series Straight (1C358-8-4)

Fittings (cont.)

- Seal-Lok (O-ring Face Seal) Female Swivel Straight (1JS58-4-4)
- Seal-Lok (O-ring Face Seal) Female Swivel Short Straight (1JC58-4-4)
- Male Straight Thread with O-ring (O-ring Boss) Straight (10558-4-4)

Colors

- Black

Notes

Not to be used for pneumatic or gaseous service
 Not to be used with chlorinated solvents
 Factory built assembly only or assembled by Parker certified assembler
 Assemblies require bend restrictors (HG569-4) to reduce the risk of exceeding the minimum hose bending radius at the fitting
 Warning tag (569-4-TAG) required for all assemblies
 Non-perforated cover

For detailed ordering information, please consult price list or contact Parflex® Division.

Parker Hannifin Corporation | Parflex® Division | Ravenna, Ohio | parker.com/pfd

www.comoso.com



573X – Fast Response Hose



Features

- Fast response even over longer lengths
- 3000 psi constant pressure

Certifications

- MSHA Accepted -3 only

Applications/Markets



- Marine, offshore drilling
- Applications requiring fast and accurate response time



Part Number	Nominal I.D.		Maximum O.D.		Maximum Working Pressure		Minimum Bend Radius		Vac. Rating Hg./73°F	Weight		Permanent Fitting Series
	inch	mm	inch	mm	psi	MPa	inch	mm		lbs./ft.	kg./mtr.	
#												
573X-3	3/16	5	.34	9	3,000	20.7	2.00	51	28	.03	.04	LV
573X-16	1	25	1.46	37	3,000	20.7	10.00	254	28	.41	.60	LV

Construction

Tube: Nylon

Reinforcement: Aramid fiber

Cover: Polyurethane

Operating Parameters

Temperature Range:

-40°F to +200°F (-40°C to +93°C)

Change in length at Max. Working Pressure: ±2%

Min. Burst Pressure is 4x Max. Working Pressure at 73°F (23°C)

Fittings

LV Series – pg. E-124

For most Parker products, Crimp Die Selection charts can be found online at www.parker.com/crimpsource.

Access instructions are on pg. G-13

Colors

- Black

Notes

Non-perforated cover

Factory-made assemblies only

575X – Fast Response Hose



Features

- Fast response even over longer lengths
- 5000 psi constant pressure

Certifications

- MSHA Accepted

Applications/Markets



- Marine, offshore drilling
- Applications requiring fast and accurate response time

Part Number	Nominal I.D.		Maximum O.D.		Maximum Working Pressure		Minimum Bend Radius		Vac. Rating Hg./73°F	Weight		Permanent Fitting Series
	inch	mm	inch	mm	psi	MPa	inch	mm		lbs./ft.	kg./mtr.	
#												
575X-3	3/16	5	.43	11	5,000	34.5	1.50	38	28	.05	.07	55
575X-4	1/4	6	.51	13	5,000	34.5	2.00	51	28	.07	.10	55
575X-6	3/8	10	.64	16	5,000	34.5	3.00	76	28	.09	.13	55
575X-8	1/2	13	.81	21	5,000	34.5	4.00	102	28	.14	.21	55
575X-12	3/4	19	1.15	29	5,000	34.5	8.00	203	28	.24	.36	58H
575X-16	1	25	1.59	40	5,000	34.5	10.00	254	28	.36	.54	58H

Construction

Tube: Nylon
 Reinforcement: Fiber
 Cover: Polyurethane

Operating Parameters

Temperature Range:
 -40°F to +212°F (-40°C to +100°C)
 Change in length at Max. Working Pressure: ±2%
 Min. Burst Pressure is 4x Max. Working Pressure at 73°F (23°C)

Fittings

55 Series – pg. E-12
 58H Series – pg. E-61
 For most Parker products, Crimp Die Selection charts can be found online at www.parker.com/crimpsource
 Access instructions are on pg. G-13

Colors

- Black

Notes

Non-perforated cover

For detailed ordering information, please consult price list or contact Parflex® Division.

Parker Hannifin Corporation | Parflex® Division | Ravenna, Ohio | parker.com/pfd

www.comoso.com



580N/H580N/588N – High Pressure Hose



Features

- Twin and multi-line available
- Lighter weight and smaller O.D. than 100R2

Certifications

- Meets/Exceeds SAE 100R8 specifications
- 580N MSHA Approved
- 588N Meets SAE J517 for less than 50 micro-amps leakage under 75,000 volts per foot

Applications/Markets



- Hydraulic and pneumatic circuits and systems
- Replaces 100R2 rubber hose wherever greater flexibility, fluid compatibility, and cover durability are required

Part Number		Nominal I.D.		Maximum O.D.		Maximum Working Pressure		Minimum Bend Radius		Vac. Rating Hg./73°F	Weight		Permanent Fitting Series
#	#												
Natural	Non-Conductive	inch	mm	inch	mm	psi	MPa	inch	mm	inch	lbs./ft.	kg./mtr.	
580N-4	588N-4	1/4	6	.62	16	5,000	34.5	2.00	51	28	.11	.16	58
580N-6	588N-6	3/8	10	.77	20	4,000	27.6	2.50	64	28	.15	.22	58
580N-8	588N-8	1/2	13	.89	23	3,500	24.1	4.00	102	28	.21	.31	56/58
580N-10	588N-10	5/8	16	.98	25	2,750	19.0	6.00	152	28	.21	.31	56/58
580N-12	588N-12	3/4	19	1.15	29	2,250	15.5	8.00	203	28	.23	.35	56/58
580N-16	588N-16	1	25	1.47	37	2,000	13.8	10.00	254	28	.38	.56	56/58
H580N-16*	-	1	25	1.58	40	3,000	20.7	10.00	254	28	.53	.79	58H

Construction

Tube: Nylon
Reinforcement: Fiber
Cover: Polyurethane

Operating Parameters

Temperature Range:
-40°F to +212°F (-40°C to +100°C)
Change in length at Max. Working Pressure: ±2%
Min. Burst Pressure is 4x Max. Working Pressure at 73°F (23°C)

Fittings

58 Series – pg. E-12 56 Series – pg. E-36
58H Series – pg. E-61

For most Parker products, Crimp Die Selection charts can be found online at www.parker.com/crimpsource

Access instructions are on pg. G-13

Colors

- Black
- Orange (Non-Conductive)

Notes

Perforated cover - 580N

*Non-perforated cover -588N, H580N-16

83FR – DuraGard™ General Purpose Polyurethane



Features

- Weld spatter resistant
- Excellent abrasion resistance
- Extreme flexibility
- Compact bend radius
- Specially formulated polyurethane tube
- Twin-line or multi-line constructions available

Certifications

- MSHA Accepted
- Non-conductive per SAEJ343 test procedures for thermoplastic hose
- UL94HB compliant

Applications/Markets



- General purpose air and water hose often used in robotic welding applications

Part Number	Nominal I.D.		Maximum O.D.		Maximum Working Pressure		Minimum Bend Radius		Vac. Rating Hg./73°F	Weight		Permanent Fitting Series	PushLok Fitting*
	inch	mm	inch	mm	psi	MPa	inch	mm		lbs./ft.	kg./mtr.		
#													
83FR-4*	1/4	6	.48	12	300	2.1	1.00	25	28	.05	.07	55/56	82**
83FR-6	3/8	10	.60	15	300	2.1	2.00	51	28	.08	.11	55/56	82**
83FR-8	1/2	13	.76	19	300	2.1	2.50	64	28	.12	.17	55/56	82**
83FR-12	3/4	19	1.04	26	300	2.1	3.50	89	28	.19	.28	55/56	82**

Construction

Tube: Specially formulated polyurethane
 Reinforcement: Fiber
 Cover: Polyurethane

Operating Parameters

Temperature Range:
 -20°F to +200°F (-29°C to +93°C)
 Change in length at Max. Working Pressure: ±2%
 Min. Burst Pressure is 4x Max. Working Pressure at 73°F (23°C)

Fittings

55 Series – pg. E-12 56 Series – pg. E-36
 82 Series – (**82 Series Fittings available from Parker Hose Products Division)
 For most Parker products, Crimp Die Selection charts can be found online at www.parker.com/crimpsource
 Access instructions are on pg. G-13

Colors

- Black (BLK)
- Blue (BLU)
- Brown (BRN)
- Green (GRN)
- Gray (GRA)
- Red (RED)

Notes

*Temperature and pressure reduced with 82 series
 Push-Lok Fitting:
 -20°F to +145°F (-29°C to +63°C)
 175 psi maximum working pressure
 For -4 hose with 56 series fitting, use die P04J
 Non-perforated cover

For detailed ordering information, please consult price list or contact Parflex® Division.

Parker Hannifin Corporation | Parflex® Division | Ravenna, Ohio | parker.com/pfd

www.comoso.com



A-55

A Hose
 B Tubing
 C Coiled Air Hose & Fittings
 D Transportation
 E Fittings
 F Tooling, Equipment & Accessories
 G General Technical

1035A – Power Cleaning



Features

- Non-marring
- Extremely flexible

Applications/Markets



- Pressure Washers (low pressure)
- Carpet Cleaning

Part Number	Nominal I.D.		Maximum O.D.		Maximum Working Pressure		Minimum Bend Radius		Vac. Rating Hg./73°F	Weight		Permanent Fitting Series
	inch	mm	inch	mm	psi	MPa	inch	mm		lbs./ft.	kg./mtr.	
#												
1035A-4	1/4	6	.51	13	1,500	10.3	.63	16	28	.08	.13	55
1035A-6	3/8	10	.62	16	1,200	8.3	.88	22	28	.10	.15	55

Construction

Tube: Special PFX compound
 Reinforcement: Fiber
 Cover: Polyurethane

Operating Parameters

Temperature Range:
 -25°F to +212°F (-32°C to +100°C)
 Change in length at Max. Working Pressure: ±2%
 Min. Burst Pressure is 4x Max. Working Pressure at 73°F (23°C)

Fittings

55 Series – pg. E-12
 For most Parker products, Crimp Die Selection charts can be found online at www.parker.com/crimpsource
 Access instructions are on pg. G-13

Colors

- Blue

Notes

Perforated cover
 No chlorinated solvents should be used
 HBR (Hose Bend Restrictor) suggested for carpet cleaning applications - See Hose Guard in Tooling Equipment and Accessories Section pg. F-18

1035HT – High Temperature Power Cleaning



Features

- Non-marring
- Broad temperature range

Applications/Markets



- Pressure Washers (low pressure)
- Carpet Cleaning

Part Number	Nominal I.D.		Maximum O.D.		Maximum Working Pressure		Minimum Bend Radius		Vac. Rating Hg./73°F	Weight		Permanent Fitting Series
	inch	mm	inch	mm	psi	MPa	inch	mm		lbs./ft.	kg./mtr.	
#												
1035HT-3	3/16	5	.43	11	2,000	13.8	0.75	19	28	.04	.06	55
1035HT-4	1/4	6	.50	13	1,750	12.1	1.50	38	28	.06	.08	55/56
1035HT-6	3/8	10	.65	17	1,500	10.3	2.00	51	28	.09	.13	55/56

Construction

Tube: Nylon
 Reinforcement: Fiber
 Cover: Polyurethane

Operating Parameters

Temperature Range:
 -40°F to +230°F (-40°C to +110°C)
 Change in length at Max. Working Pressure: ±2%
 Min. Burst Pressure is 4x Max. Working Pressure at 73°F (23°C)

Fittings

55 Series – pg. E-12 56 Series – pg. E-36
 For most Parker products, Crimp Die Selection charts can be found online at www.parker.com/crimpsource
 Access instructions are on pg. G-13

Colors

- Yellow

Notes

Perforated cover
 No chlorinated solvents should be used
 HBR (Hose Bend Restrictor) suggested for carpet cleaning applications - See Hose Guard in Tooling Equipment and Accessories Section pg. F-18

For detailed ordering information, please consult price list or contact Parflex® Division.

Parker Hannifin Corporation | Parflex® Division | Ravenna, Ohio | parker.com/pfd

www.comoso.com



A-57

A Hose
 B Tubing
 C Coiled Air Hose & Fittings
 D Transportation
 E Fittings
 F Tooling, Equipment & Accessories
 G General Technical

B9 - General Purpose Transfer Hose



Features

- Excellent flexibility

Applications/Markets



- Low pressure transmission of air, oil, water, and coolants



Part Number	Nominal I.D.		Maximum O.D.		Maximum Working Pressure		Minimum Bend Radius		Weight		Vac. Rating Hg./73°F	Permanent Fitting Series	Field Attachable Series
	inch	mm	inch	mm	psi	MPa	inch	mm	lbs./ft.	kg./mtr.			
#													
B903	3/16	5	.39	10	250	1.7	1.00	25	.04	.06	28	55/56	–
B904	1/4	6	.46	12	250	1.7	1.50	38	.05	.07	28	55/56	82*
B905	5/16	8	.55	14	250	1.7	2.00	51	.08	.12	28	55/56	–
B906	3/8	10	.64	16	250	1.7	3.00	76	.09	.13	28	55/56	82*
B908	1/2	13	.78	20	250	1.7	3.00	76	.13	.19	28	55/56	82*
B910	5/8	16	.93	24	250	1.7	4.00	102	.20	.30	28	55/56/HY***	82*

Construction

Tube: Specially formulated polyurethane

Reinforcement: Fiber

Cover: Specially formulated polyurethane

For most Parker products, Crimp Die Selection charts can be found online at www.parker.com/crimpsource

Access instructions are on pg. G-13

Colors

- Red
- Black (BK)

Notes

*Temperature and pressure reduced with 82 series

Push-Lok Fitting:

-20°F to +100°F (-29°C to +38°C)

100 psi maximum working pressure

Non-perforated cover

Operating Parameters

Temperature Range:

-40°F to +200°F (-40° C to +93° C)

(Limited to +130°F (+54°C) for water and water-based fluids)

Change in length at Max. Working Pressure: ±2%

Min. Burst Pressure is 4x Max. Working Pressure at 73°F (23°C)

Fittings

55 Series - pg. E-12 56 Series - pg. E-36

82 Series - (*82 Series Fittings available from Parker Hose Products Division)

HY Series - pg. E-107 (**HY Fittings available from Parker Hose Products Division)



For detailed ordering information, please consult price list or contact Parflex® Division.

CNG – Electrically Conductive Compressed Natural Gas Hose



Features

- Twin constructions available

Certifications

Conforms to:

- NFPA 52
- ANSI/IAS NGV 4.2
- ECE R110 - Sizes -3 and -8 only for assemblies purchased through Parker Polyflex (Europe)
- CSA12.52

Applications/Markets



- CNG Dispenser/Refueling
- Fleet Transit/On-Vehicle
- CNG Fuel Transfer
- At-Home CNG Refueling

Part Number	Nominal I.D.		Maximum O.D.		Maximum Working Pressure		Minimum Bend Radius		Weight	
	inch	mm	inch	mm	psi	MPa	inch	mm	lbs./ft.	kg./mtr.
#										
5CNG-3	3/16	5	.43	11	5,000	34.5	1.50	38	.05	.07
5CNG-4	1/4	6	.55	14	5,000	34.5	2.00	51	.08	.11
5CNG-6	3/8	10	.65	16	5,000	34.5	3.00	76	.09	.13
5CNG-8	1/2	13	.90	23	5,000	34.5	4.00	102	.21	.31
5CNG-12	3/4	19	1.15	29	5,000	34.5	7.50	191	.24	.36
5CNG-16	1	25	1.59	40	5,000	34.5	10.00	254	.36	.53

Construction

Tube: Electrically conductive nylon

Reinforcement: Fiber

Cover: Polyurethane

Operating Parameters

Temperature Range:

-40°F to +180°F (-40°C to +82°C)

Min. Burst Pressure is 4x Max. Working Pressure at 73°F (23°C)

Fittings

Factory-made assemblies only

55 Series – pg. E-12 58 Series – pg. E-12

58H Series – pg. E-61

For most Parker products, Crimp Die Selection charts can be found online at www.parker.com/crimpsource

Access instructions are on pg. G-13

Colors

- Red

Notes

Perforated cover

CNG hose must be assembled at the factory or by a Parflex approved facility

Wire spring guards must be used on ANSI/CSA design certified CNG dispenser hose assembly sizes -3 through -8: single and multi-line bonded assemblies - pg. F-21

Accessories

PSG - Wire spring guard

CNGG - Vinyl hose guard

Consult Parflex CAT. 4660 for CNG guard selection

For detailed ordering information, please consult price list or contact Parflex® Division.

Parker Hannifin Corporation | Parflex® Division | Ravenna, Ohio | parker.com/pfd

www.comoso.com



A-59

HLB – Lubrication Line Hose



Features

- HLB remote lubrication system versus 1/4" rubber hoses can save money per line in reduced component and installation labor costs
- Unique GK bulkhead hose fittings with integrated nipple can save money per zerk connection in unnecessary adapter costs
- Compact 1/8" hoses save hundreds of dollars of waste in your operation by eliminating gallons of unnecessary "in-line" grease versus larger bore rubber hoses

Certifications

- MSHA Accepted

Applications/Markets



- Grease and lubrication lines
- Agriculture
- Construction
- Industrial
- Material Handling
- Mobile Equipment
- Transportation

Part Number	Nominal I.D.		Maximum O.D.		Maximum Working Pressure		Minimum Bend Radius		Vac. Rating Hg./73°F	Weight		Permanent Fitting Series	Field Attachable Series
	inch	mm	inch	mm	psi	MPa	inch	mm		lbs./ft.	kg./mtr.		
#													
HLB02*	1/8	3.2	.32	8	3,000	20.7	.50	13	28	.03	.04	CY	BU
HLB03**	3/16	4.8	.41	10	3,000	20.7	.75	19	28	.06	.08	CY	BU

Construction

Tube: Copolyester
Reinforcement: Fiber
Cover: Polyurethane

Operating Parameters

Temperature Range:

-40°F to +212°F (-40°C to +100°C) with CY fittings
(Limited to +135°F (+57°C) for synthetic hydraulic fluids and water-based fluids)

BU Series Field Attachable Fitting limited to 120°F

Change in length at Max. Working Pressure: ±3%

Min. Burst Pressure is 4x Max. Working Pressure at 73°F (23°C)

Fittings

BU Series – pg. E-100

CY Series – pg. E-101

For most Parker products, Crimp Die Selection charts can be found online at www.parker.com/crimpsource

Access instructions are on pg. G-13

Colors

- Black

Notes

Not for use as a whip hose on hand-operated grease guns

Bend restrictions are available only for permanent fittings.

HBR (Hose Bend Restrictor) available for Marine Steering Hose Assemblies. See Hose Guard in Tooling Equipment and Accessories Section pg. F-18

*HLB-2 - Guard P.N. CY02-652317

**HLB-3 - Guard P.N. 3PSG-4

MSH – Marine Steering Fast Response Hose



Features

- Fast, accurate response
- Permanent or field attachable
- Salt water, corrosion resistant

Applications/Markets



- Wide range of marine applications
- Marine hydraulic steering systems

Part Number	Nominal I.D.		Maximum O.D.		Maximum Working Pressure		Minimum Bend Radius		Vac. Rating Hg./73°F	Weight		Permanent Fitting Series	Field Attachable Series
	inch	mm	inch	mm	psi	MPa	inch	mm		lbs./ft.	kg./mtr.		
#													
MSH-5	5/16	8	.48	12	1,000	6.9	2.25	57	28	.05	.07	MS	MS
MSH-6	3/8	10	.59	15	1,000	6.9	3.00	76	28	.07	.11	MS	MS

Construction

Tube: Nylon
 Reinforcement: Fiber
 Cover: Polyurethane

Operating Parameters

Temperature Range:
 -40°F to +200°F (-40°C to +93°C)
 (Limited to +135°F (+57°C) for synthetic hydraulic fluids and water-based fluids)

Change in length at Max. Working Pressure: ±2%
 Min. Burst Pressure is 4x Max. Working Pressure at 73°F (23°C)

Fittings

MS Series – pg. E-125
 For most Parker products, Crimp Die Selection charts can be found online at www.parker.com/crimpsource
 Access instructions are on pg. G-13

Colors

- Black

Notes

Non-perforated cover
 Bend restrictions are available only for permanent fittings.
 HBR (Hose Bend Restrictor) available for Marine Steering Hose Assemblies. See Hose Guard in Tooling Equipment and Accessories Section pg. F-18

For detailed ordering information, please consult price list or contact Parflex® Division.

Parker Hannifin Corporation | Parflex® Division | Ravenna, Ohio | parker.com/pfd

www.comoso.com



A-61

A Hose
 B Tubing
 C Coiled Air Hose & Fittings
 D Transportation
 E Fittings
 F Tooling, Equipment & Accessories
 G General Technical

PTH – Marine Power Tilt Hose



Features

- Compact design
- Abrasion resistant polyurethane cover
- Excellent flexibility
- Corrosion resistant

Applications/Markets



- Power tilt mechanisms for outboard and stern drive engines
- Trim Tab assemblies
- Jack Plate assemblies

Part Number	Nominal I.D.		Maximum O.D.		Maximum Working Pressure		Vac. Rating Hg./73°F	Minimum Bend Radius			Weight		Permanent Fitting Series
	inch	mm	inch	mm	psi	MPa		inch	inch	mm	lbs./ft.	kg./mtr.	
PTH-3	3/16	5	.43	11	3,000	20.7	28	0.75	19	.08	.11	92	

Construction

Tube: Nylon
 Reinforcement: Fiber and Stainless Steel braid
 Cover: Polyurethane

Operating Parameters

Temperature Range:
 -40°F to +212°F (-40°C to +100°C)
 Change in length at Max. Working Pressure: ±2%
 Min. Burst Pressure is 4x Max. Working Pressure at 73°F (23°C)

Fittings

92 Series – pg. E-85
 For most Parker products, Crimp Die Selection charts can be found online at www.parker.com/crimpsource
 Access instructions are on pg. G-13

Colors

- Clear

Notes

Non-perforated cover
 Also available as custom order with black cover

S5N – Predator® Hose (Water Jetting/Lateral Cleaning)



Features

- Easily identified lime green cover signifies 4000 psi constant pressure
- Slim profile and light weight provide easy handling and routing

Certifications

- NSWMA (National Solid Waste Management Assoc.)
- WASTEC (Waste Equipment Technology Assoc.)
- WEMI (Waste Equipment Management Inst.)
- Specifications for repair/inspection procedures for high pressure hose used in conjunction with sewer/catch basin cleaning equipment

Applications/Markets



- High-pressure water equipment for cleaning or debris removal in lateral sewer lines
- Lines provide connection from commercial, industrial or residential structure to the main sewer line located under the streets
- Lateral lines are smaller in diameter than the main lines, and rely more on water pressure than water volume to clear residue and obstructions
- For water/slurry applications, contact Parflex for chemical compatibility recommendations

Part Number	Nominal I.D.		Maximum O.D.		Maximum Working Pressure		Minimum Bend Radius		Weight		Permanent Fitting Series
	inch	mm	inch	mm	psi	MPa	inch	mm	lbs./ft.	kg./mtr.	
S508N	1/2	13	.81	21	4000	28	4.00	102	.16	.24	55/56

Construction

Tube: Gray Copolyester
 Reinforcement: Aramid Fiber
 Cover: Polyurethane

Operating Parameters

Temperature Range:
 -40°F to +135°F for water (-40°C to +57°C)
 Min. Burst Pressure is 4x Max. Working Pressure at 73°F (23°C)

Fittings

55 Series – pg. E-12 56 Series – pg. E-36
 For most Parker products, Crimp Die Selection charts can be found online at www.parker.com/crimpsource
 Access instructions are on pg. G-13

Colors

- Green

Notes

Factory-made assemblies only
 Not for use in hydraulic applications
 Perforated cover

For detailed ordering information, please consult price list or contact Parflex® Division.

Parker Hannifin Corporation | Parflex® Division | Ravenna, Ohio | parker.com/pfd

www.comoso.com



A-63

A Hose
 B Tubing
 C Coiled Air Hose & Fittings
 D Transportation
 E Fittings
 F Tooling, Equipment & Accessories
 G General Technical

S6 – Predator® Hose (Sewer Cleaning)



Features

- Easily identified orange cover signifies 2500 psi constant pressure
- Bonded construction provides excellent kink resistance and flexibility

Certifications

- NSWMA (National Waste Management Assoc.)
- WASTEC (Waste Equipment Technology Assoc.)
- WEMI (Waste Equipment Management Inst.)
- Specifications for repair/inspection procedures for high pressure hose used in conjunction with sewer/catch basin cleaning equipment

Applications/Markets



- High-pressure and high-volume water equipment for cleaning or debris removal in large sewer lines
- For water/slurry applications, contact Parflex for chemical compatibility recommendations

Part Number	Nominal I.D.		Maximum O.D.		Maximum Working Pressure		Minimum Bend Radius		Weight		Permanent Fitting Series
	inch	mm	inch	mm	psi	MPa	inch	mm	lbs./ft.	kg./mtr.	
#											
S612	3/4	19	1.14	29	2,500	17.2	4.00	102	.29	.43	58/SQ/HY*
S616	1	25	1.41	36	2,500	17.2	6.00	152	.38	.57	58/SQ/HY*

Construction

Tube: Gray Copolyester, S624 – Gray Nylon

Reinforcement: Fiber

Cover: Polyurethane

Colors

- Orange

Notes

Factory-made assemblies only

All standard assembly lengths coupled with rigid male pipe each end

Not for use in hydraulic applications

Perforated cover - S612, S616

Operating Parameters

Temperature Range:

-40°F to +135°F (-40°C to +57°C)

Min. Burst Pressure is 2.5x Max. Working Pressure at 73°F (23°C)

Fittings

58 Series – pg. E-12

SQ Series (Swage Only)– pg. E-127

HY Series – pg. E-107 (*HY Fittings available from Parker Hose Products Division)

For most Parker products, Crimp Die Selection charts can be found online at www.parker.com/crimpsource

Access instructions are on pg. G-13

S9 – Predator® Hose (Sewer Cleaning)



Features

- Easily identified blue cover signifies 3000 psi constant pressure
- Bonded construction provides excellent kink resistance and flexibility

Certifications

- NSWMA (National Solid Waste Management Assoc.)
- WASTEC (Waste Equipment Technology Assoc.)
- WEMI (Waste Equipment Management Inst.)
- Specifications for repair/inspection procedures for high pressure hose used in conjunction with sewer/catch basin cleaning equipment

Applications/Markets



- High-pressure and high-volume water equipment for cleaning or debris removal in large sewer lines
- For water/slurry applications, contact Parflex for chemical compatibility recommendations

Part Number	Nominal I.D.		Maximum O.D.		Maximum Working Pressure		Minimum Bend Radius		Weight		Permanent Fitting Series
	inch	mm	inch	mm	psi	MPa	inch	mm	lbs./ft.	kg./mtr.	
#											
S912	3/4	19	1.15	29	3,000	20.7	4.00	102	.30	.45	58/SQ/HY*
S916	1	25	1.47	37	3,000	20.7	8.00	203	.46	.68	58/SQ/HY*

Construction

Tube: Gray Copolyester
 Reinforcement: Fiber
 Cover: Polyurethane

Operating Parameters

Temperature Range:
 -40°F to +135°F for water (-40°C to +57°C)
 Min. Burst Pressure is 2.5x Max. Working Pressure at 73°F (23°C)

Fittings

58 Series – pg. E-12
 SQ Series (Swage Only)– pg. E-127
 HY Series – pg. E-107 (*HY Fittings available from Parker Hose Products Division)
 For most Parker products, Crimp Die Selection charts can be found online at www.parker.com/crimpsource
 Access instructions are on pg. G-13

Colors

- Blue

Notes

Factory-made assemblies only
 All standard assembly lengths coupled with rigid male pipe each end
 Not for use in hydraulic applications
 Perforated cover

For detailed ordering information, please consult price list or contact Parflex® Division.

Parker Hannifin Corporation | Parflex® Division | Ravenna, Ohio | parker.com/pfd

www.comoso.com



A-65

Hose
A
Tubing
B
Coiled Air Hose & Fittings
C
Transportation
D
Fittings
E
Tooling, Equipment & Accessories
F
General Technical
G

SLH – Sewer Leader Hose



Features

- Easily identified black cover indicates termination of hose

Certifications

- NSWMA (National Solid Waste Management Assoc.)
- WASTEC (Waste Equipment Technology Assoc.)
- WEMI (Waste Equipment Management Inst.)

Applications/Markets



- Leader hose for S4/S5/S6/S9 high-pressure sewer cleaning hose

Part Number	Nominal I.D.		Maximum O.D.		Maximum Working Pressure		Minimum Bend Radius		Vac. Rating Hg./73°F	Weight		Permanent Fitting Series
	inch	mm	inch	mm	psi	MPa	inch	mm		lbs./ft.	kg./mtr.	
#												
SLH-8	1/2	13	0.77	20	4,000	27.6	3.50	89	28	.25	.37	58/HY*
SLH-10	5/8	16	0.95	24	4,000	27.6	4.00	102	28	.38	.57	HY*
SLH-12	3/4	19	1.08	27	3,000	20.7	4.80	122	28	.45	.67	HY*
SLH-16	1	25	1.43	36	3,000	20.7	6.00	152	28	.80	1.19	HY*

Construction

Tube: Gray Copolyester

Reinforcement: Wire

Cover: Smooth synthetic rubber

Operating Parameters

Temperature Range:

-40°F to +150°F (-40°C to +66°C)

Min. Burst Pressure is 2.5x Max. Working Pressure at 73°F (23°C)

Fittings

58 Series – pg. E-12

HY Series – pg. E-107 (*HY Fittings available from Parker Hose Products Division)

For most Parker products, Crimp Die Selection charts can be found online at www.parker.com/crimpsource

Access instructions are on pg. G-13

Colors

- Black

Notes

Factory-made assemblies only

Not for use in hydraulic applications

Perforated cover

Duraflex™ Hydraulic Hose Coil



Features

- Bonded twin-line construction
- Self retracting coil design

Certifications

- Meets/Exceeds SAE 100R7
- Meets SAE J517 for less than 50 micro-amps leakage under 75,000 volts per foot

Applications/Markets



- Hydraulic tool hose for aerial lift applications
- General Hydraulics

Part Number	Nominal I.D.		Maximum O.D.		Maximum Working Pressure		Minimum Bend Radius		Vac. Rating Hg./73°F	Weight		Permanent Fitting Series
	inch	mm	inch	mm	psi	MPa	inch	mm		lbs./ft.	kg./mtr.	
#												
548N-6	3/8	10	.65	17	2,250	15.5	2.00	51	28	.09	.13	55/56

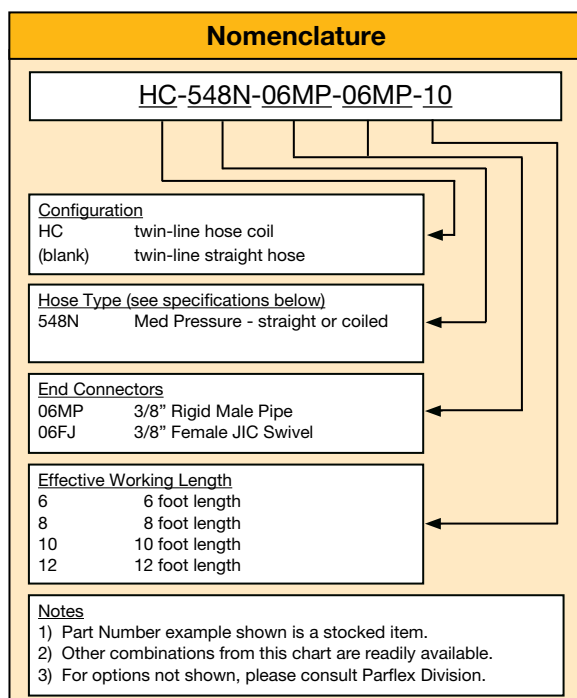

Construction

Tube: Nylon
 Reinforcement: Fiber
 Cover: Polyurethane

Operating Parameters

Temperature Range:
 -40°F to +212°F (-40°C to +100°C)
 Change in length at Max. Working Pressure: ±2%
 Min. Burst Pressure is 4x Max. Working Pressure at 73°F (23°C)

Fittings

55 Series – pg. E-12 56 Series – pg. E-36

For most Parker products, Crimp Die Selection charts can be found online at www.parker.com/crimpsource

Access instructions are on pg. G-13

Colors

- Orange (Non-Conductive)

Notes

Non-perforated cover

For detailed ordering information, please consult price list or contact Parflex® Division.

Parker Hannifin Corporation | Parflex® Division | Ravenna, Ohio | parker.com/pfd

www.comoso.com



A-67

919/919B – PTFE Hose



Features

- Excellent chemical compatibility
- Handles extreme temperatures to +450°F
- Environmentally safe
- Resists moisture
- Low friction minimizes pressure drops and deposits

Certifications

- Meets/Exceeds SAE 100R14A - 919
- Meets/Exceeds SAE 100R14B - 919B
- FDA CFR 177.1550 (Natural tube)

Applications/Markets



- Chemical Transfer Lines
- General Hydraulics
- Compressed Air/Gases
- Adhesive Dispensing
- Coolant Lines
- Medical Gases

Part Number		Nominal I.D.		Maximum O.D.		Maximum Working Pressure		Minimum Bend Radius		Vac. Rating Hg./73°F	Weight		Permanent Fitting Series	Field Attachable Series
#	#													
Natural	Conductive	inch	mm	inch	mm	psi	MPa	inch	mm	inch	lbs./ft.	kg./mtr.		
919-3	-	1/8	3	.25	6	3,000	20.7	1.50	38	28	.04	.06	91	-
919-4	919B-4	3/16	5	.32	8	3,000	20.7	2.00	51	28	.06	.09	91N	90
919-5	919B-5	1/4	6	.38	10	3,000	20.7	3.00	76	28	.09	.13	91N	90
919-6	919B-6	5/16	8	.44	11	2,500	17.2	4.00	102	28	.10	.15	91N	90
919-8	919B-8	13/32	10	.53	13	2,000	13.8	5.00	127	28	.13	.19	91N	90
919-10	-	1/2	13	.63	16	1,500	10.3	6.50	165	28	.15	.22	91N	90
919-12	-	5/8	16	.75	19	1,200	8.3	7.50	191	12	.19	.28	91N	90
919-16	-	7/8	22	1.03	26	1,000	6.9	9.00	229	14	.27	.40	91N	90
919-20	-	1-1/8	29	1.28	33	625	4.3	16.00	406	10	.39	.58	91	90

Construction

Tube: 919 - Natural FDA Compliant PTFE
 919B - Black Static-Dissipative PTFE
 Reinforcement: 304 Stainless Steel braid

Operating Parameters

Temperature Range:

-100°F to +450°F (-73°C to +232°C)

Change in length at Max. Working Pressure: +2% to -4%

Min. Burst Pressure is 4x Max. Working Pressure at 73°F (23°C)

Fittings

90 Series – pg. E-65

91/91N Series – pg. E-72

For most Parker products, Crimp Die Selection charts can be found online at www.parker.com/crimpsource

Access instructions are on pg. G-13

Notes

Use hose type 919B with static-dissipative core tube when conveying non-conducting fluids such as oils, paints, fuels, steam, etc.

919J – Silicone Covered PTFE Hose



Features

- Silicone cover provides a clean, smooth cover to protect the stainless steel wire reinforcement against wear, fraying and contaminants
- Steam cleanable

Certifications

- Meets/Exceeds SAE 100R14A
- FDA CFR 177.1550

Applications/Markets



- Chemical Transfer Lines
- General Hydraulics
- Compressed Air/Gases
- Adhesive Dispensing
- Coolant Lines
- Medical Gases

Part Number	Nominal I.D.		Maximum O.D.		Maximum Working Pressure		Minimum Bend Radius		Vac. Rating Hg./73°F	Weight		Permanent Fitting Series
	#											
	inch	mm	inch	mm	psi	MPa	inch	mm	inch	lbs./ft.	kg./mtr.	
919J-4-RED	3/16	5	.45	11	3,000	20.7	2.00	51	28	.12	.18	91N
919J-5-RED	1/4	6	.52	13	3,000	20.7	3.00	76	28	.14	.21	91N
919J-6-RED	5/16	8	.58	15	2,500	17.2	4.00	102	28	.17	.25	91N
919J-8-RED	13/32	10	.68	17	2,000	13.8	5.00	127	28	.20	.30	91N
919J-10-RED	1/2	13	.78	20	1,500	10.3	6.50	165	28	.24	.35	91N
919J-12-RED	5/8	16	.91	23	1,200	8.3	7.50	191	12	.29	.43	91N

Construction

Tube: Natural FDA compliant PTFE
 Reinforcement: 304 Stainless Steel braid
 Cover: Extruded silicone

Operating Parameters

Temperature Range:
 -40°F to +450°F (-40°C to +232°C)
 Change in length at Max. Working Pressure: +2% to -4%
 Min. Burst Pressure is 4x Max. Working Pressure at 73°F (23°C)

Fittings

91N Series - pg. E-72
 For most Parker products, Crimp Die Selection charts can be found online at www.parker.com/crimpsource
 Access instructions are on pg. G-13

Colors

- Red

Notes

Cover must be skived prior to fitting attachment

For detailed ordering information, please consult price list or contact Parflex® Division.

Parker Hannifin Corporation | Parflex® Division | Ravenna, Ohio | parker.com/pfd

www.comoso.com



919U – High Abrasion Resistance PTFE Hose



Features

- Non-Marring, abrasion resistant polyurethane cover protects the stainless steel wire reinforcement against wear, fraying and contaminants

Certifications

- Meets/Exceeds SAE 100R14A but operates at a temperature range of -40°F to +275°F
- FDA CFR 177.1550

Applications/Markets



- Chemical Transfer Lines
- General Hydraulics
- Compressed Air/Gases
- Adhesive Dispensing
- Coolant Lines
- Medical Gases

Part Number	Nominal I.D.		Maximum O.D.		Maximum Working Pressure		Minimum Bend Radius		Vac. Rating Hg./73°F	Weight		Permanent Fitting Series
	inch	mm	inch	mm	psi	MPa	inch	mm		lbs./ft.	kg./mtr.	
#												
919U-4	3/16	5	.37	9	3,000	20.7	2.00	51	28	.08	.13	91N
919U-6	5/16	8	.51	13	2,500	17.2	4.00	102	28	.13	.20	91N
919U-8	13/32	10	.61	15	2,000	13.8	5.00	127	28	.15	.22	91N
919U-12	5/8	16	.84	21	1,200	8.3	7.50	191	12	.22	.33	91N
919U-16	7/8	22	1.12	28	1,000	6.9	9.00	229	14	.31	.47	91N

Construction

Tube: Natural FDA compliant PTFE
 Reinforcement: 304 Stainless Steel braid
 Cover: Polyurethane

Fittings

91N Series – pg. E-72

For most Parker products, Crimp Die Selection charts can be found online at www.parker.com/crimpsource

Access instructions are on pg. G-13

Operating Parameters

Temperature Range:

-40°F to +275°F (-40°C to +135°C)

Change in length at Max. Working Pressure: +2% to -4%

Min. Burst Pressure is 4x Max. Working Pressure at 73°F (23°C)

Colors

- Black

Notes

Cover must be skived prior to fitting attachment

Other colors available upon request

929/929B – Heavy Wall PTFE Hose



Features

- Tight bend radius
- Excellent kink resistance
- Enhanced resistance to gas permeation due to increased PTFE wall thickness (.040")

Certifications

- Meets/Exceeds SAE 100R14A - 929
- Meets/Exceeds SAE 100R14B - 929B
- FDA CFR 177.1550 (Natural tube)

Applications/Markets



- Chemical Transfer Lines
- General Hydraulics
- Compressed Air/Gases
- Adhesive Dispensing
- Coolant Lines
- Medical Gases
- 919 (100R14) hose applications requiring tight routings

Part Number		Nominal I.D.		Maximum O.D.		Maximum Working Pressure		Minimum Bend Radius		Vac. Rating Hg./73°F	Weight		Permanent Fitting Series
#	#												
Natural	Conductive	inch	mm	inch	mm	psi	MPa	inch	mm	inch	lbs./ft.	kg./mtr.	
929-4	929B-4	3/16	5	.34	9	3,000	20.7	2.00	51	28	.08	.12	91N
929-6	929B-6	5/16	8	.47	12	2,500	17.2	4.00	102	28	.12	.18	91N
929-8	929B-8	13/32	10	.59	15	2,000	13.8	4.60	117	28	.16	.23	91N
-	929B-12	5/8	16	.81	21	1,200	8.3	6.50	165	12	.19	.28	91N
-	929B-16	7/8	22	1.14	29	1,250	8.6	7.40	188	12	.49	.73	91N

Construction

Tube: 929 - Natural FDA Compliant PTFE
 929B - Black Static-Dissipative PTFE
 Reinforcement: 304 Stainless Steel braid

Operating Parameters

Temperature Range:
 -100°F to +450°F (-73°C to +232°C)
 Change in length at Max. Working Pressure: +2% to -4%
 Min. Burst Pressure is 4x Max. Working Pressure at 73°F (23°C)

Fittings

91N Series – pg. E-72
 For most Parker products, Crimp Die Selection charts can be found online at www.parker.com/crimpsource
 Access instructions are on pg. G-13

Notes

Use hose type 929B with static-dissipative core tube when conveying non-conducting fluids such as oils, paints, fuels, steam, etc.

For detailed ordering information, please consult price list or contact Parflex® Division.

Parker Hannifin Corporation | Parflex® Division | Ravenna, Ohio | parker.com/pfd

www.comoso.com



929BJ – Silicone Covered PTFE Hose (with Static-Dissipative Tube)



Features

- Silicone cover protects SS wire reinforcement against wear and fraying, up to 450°F
- Silicone cover provides clean, smooth cover and prevents contaminants from accumulating in braid
- Tight bend radius
- Excellent kink resistance
- Enhanced resistance to gas permeation due to increased PTFE wall thickness
- Steam cleanable

Applications/Markets



- Vacuum lines for high temperature autoclaves
- General Hydraulics
- Compressed Air/Gases

Part Number	Nominal I.D.		Maximum O.D.		Tube Wall		Maximum Working Pressure		Minimum Bend Radius		Vac. Rating Hg./73°F	Weight		Permanent Fitting Series
	inch	mm	inch	mm	inch	mm	psi	MPa	inch	mm		lbs./ft.	kg./mtr.	
#														
929BJ-4	3/16	5	.58	15	.040	1.02	3,000	20.7	2.00	51	28	.17	.25	91N
929BJ-6	5/16	8	.70	18	.040	1.02	2,500	17.2	4.00	102	28	.23	.34	91N
929BJ-8	13/32	10	.81	20	.044	1.12	2,000	13.8	4.60	117	28	.29	.43	91N

Construction

Tube: Black static-dissipative PTFE
 Reinforcement: 304 Stainless Steel braid
 Cover: Silicone cover

Operating Parameters

Temperature Range:
 -65°F to +450°F (-54°C to +232°C)
 Change in length at Max. Working Pressure: +2% to -4%
 Min. Burst Pressure is 4x Max. Working Pressure at 73°F (23°C)

Fittings

91N Series – pg. E-72
 For most Parker products, Crimp Die Selection charts can be found online at www.parker.com/crimpsource
 Access instructions are on pg. G-13

Colors

● Brown

Notes

Cover must be skived prior to fitting attachment

939/939B – Convoluted PTFE Hose



Features

- Excellent flexibility
- Exceptional kink resistance

Certifications

- FDA CFR 177.1550 (Natural tube)

Applications/Markets



- Chemical Transfer
- General Hydraulics
- Hose applications requiring tight routings

Part Number		Nominal I.D.		Maximum O.D.		Maximum Working Pressure		Minimum Bend Radius		Vac. Rating Hg./73°F	Weight		Permanent Fitting Series
#	#												
Natural	Conductive	inch	mm	inch	mm	psi	MPa	inch	mm	inch	lbs./ft.	kg./mtr.	
939-6	939B-6	3/8	10	.59	15	1,500	10.3	2.25	57	28	.12	.18	93N
939-8	939B-8	1/2	13	.79	20	1,350	9.3	2.88	73	28	.21	.31	93N
939-10	939B-10	5/8	16	.88	22	1,000	6.9	3.00	76	28	.24	.36	93N
939-12	939B-12	3/4	19	1.09	28	1,100	7.6	3.75	95	28	.32	.47	93N
939-16	939B-16	1	25	1.33	34	1,000	6.9	5.00	127	28	.45	.67	93N
939-20	939B-20	1-1/4	32	1.75	44	1,000	6.9	6.25	159	20*	.70	1.04	93N
939-24	939B-24	1-1/2	38	2.05	52	750	5.2	7.50	191	12*	.80	1.18	93N
939-32	939B-32	2	51	2.56	65	250	1.7	10.00	254	5*	1.01	1.50	93N

Construction

Tube: 939 - Natural FDA Compliant PTFE
 939B - Black Static-Dissipative PTFE
 Reinforcement: 304 Stainless Steel braid

Operating Parameters

Temperature Range:
 -100°F to +450°F (-73°C to +232°C)
 Change in length at Max. Working Pressure: +2% to -4%
 Min. Burst Pressure is 4x Max. Working Pressure at 73°F (23°C)

Fittings

93N Series – pg. E-87
 For most Parker products, Crimp Die Selection charts can be found online at www.parker.com/crimpsource
 Access instructions are on pg. G-13

Notes

Use hose type 939B with static-dissipative core tube when conveying non-conducting fluids such as oils, paints, fuels, steam, etc.
 Not suggested for steam-cold water cycling applications
 * 28 in/Hg can be obtained by using 2799 internal spring guard. See pg. F-20

For detailed ordering information, please consult price list or contact Parflex® Division.

Parker Hannifin Corporation | Parflex® Division | Ravenna, Ohio | parker.com/pfd

www.comoso.com



A-73

A Hose
 B Tubing
 C Coiled Air Hose & Fittings
 D Transportation
 E Fittings
 F Tooling, Equipment & Accessories
 G General Technical

943B – 3,000 psi W.P. High Temp Hose



Features

- High temperature hydraulic hose
- Excellent chemical compatibility
- Resists moisture
- Low friction minimizes pressure drops and deposits

Certifications

- Meets/Exceeds SAE 100R7 and SAE 100R17

Applications/Markets



- High temp hydraulic applications
- Chemical Transfer
- Compressed Air/Gases
- Paint Stripping

Part Number	Nominal I.D.		Maximum O.D.		Maximum Working Pressure		Minimum Bend Radius		Vac. Rating Hg./73°F	Weight		
	inch	mm	inch	mm	psi	MPa	inch	mm		lbs./ft.	kg./mtr.	
#												
943B-6	5/16	8	.49	12	3,000	20.7	2.50	64	28	.18	.26	
943B-8	13/32	10	.62	16	3,000	20.7	2.88	73	28	.24	.35	
943B-10	1/2	13	.73	19	3,000	20.7	3.25	83	28	.32	.46	
943B-12	5/8	16	.99	25	3,000	20.7	4.00	102	28	.70	1.01	
943B-16	29/32	23	1.25	32	3,000	20.7	5.00	127	28	1.02	1.53	

Construction

Tube: Black static-dissipative PTFE
Reinforcement: 304 Stainless Steel braid

Operating Parameters

Temperature Range:
-65°F to +400°F (-54°C to +204°C)
Change in length at Max. Working Pressure: ±2%
Min. Burst Pressure is 4x Max. Working Pressure at 73°F (23°C)

Fittings

94 Series – pg. E-90

Notes

Factory-made assemblies only
Not suggested for steam-cold water cycling applications

944B – 4,000-4,500 psi W.P. High Temp Hose



Features

- High temperature hydraulic hose
- Excellent chemical compatibility
- Resists moisture
- Low friction minimizes pressure drops and deposits

Applications/Markets



- General Hydraulics
- Chemical Transfer
- Compressed Air/Gases

Part Number	Nominal I.D.		Maximum O.D.		Maximum Working Pressure		Minimum Bend Radius		Vac. Rating Hg./73°F	Weight	
	inch	mm	inch	mm	psi	MPa	inch	mm		lbs./ft.	kg./mtr.
#											
944B-4	15/64	6	.39	10	4,500	31.0	1.50	38	28	.11	.16
944B-6	5/16	8	.49	12	4,500	31.0	2.50	64	28	.17	.24
944B-8	7/16	11	.62	16	4,500	31.0	2.88	73	28	.25	.35
944B-10	1/2	13	.73	19	4,000	27.6	3.25	83	28	.31	.45
944B-12	5/8	16	.99	25	4,000	27.6	4.00	102	28	.74	1.05
944B-16	29/32	23	1.25	32	4,000	27.6	5.00	127	28	1.09	1.55

Construction

Tube: Black static-dissipative PTFE
Reinforcement: 304 Stainless Steel braid

Operating Parameters

Temperature Range:
-65°F to +400°F (-54°C to +204°C)
Change in length at Max. Working Pressure: ±2%
Min. Burst Pressure is 3x Max. Working Pressure at 73°F (23°C)

Fittings

94 Series – pg. E-90

Notes

Factory-made assemblies only
Not suggested for steam-cold water cycling applications
Reduce pressure to 3,000 psi (20.7MPa) for pressure impulse applications

For detailed ordering information, please consult price list or contact Parflex® Division.

Parker Hannifin Corporation | Parflex® Division | Ravenna, Ohio | parker.com/pfd

www.comoso.com



A-75

Hose
A

Tubing
B

Coiled Air Hose
& Fittings
C

Transportation
D

Fittings
E

Tooling, Equipment
& Accessories
F

General Technical
G

950B – 4,000 psi W.P. High Temp Hose



Features

- High temperature hydraulic hose
- Excellent chemical compatibility
- Resists moisture
- Low friction minimizes pressure drops and deposits

Applications/Markets



- High temp hydraulic applications
- Chemical Transfer
- Compressed Air/Gases
- Ground Support

Part Number	Nominal I.D.		Maximum O.D.		Maximum Working Pressure		Minimum Bend Radius		Vac. Rating Hg./73°F	Weight	
	inch	mm	inch	mm	psi	MPa	inch	mm		inch	lbs./ft.
#											
950B-4	15/64	6	.50	13	4,000	27.6	3.00	76	28	.20	.27
950B-6	5/16	8	.62	16	4,000	27.6	5.00	127	28	.24	.36
950B-8	7/16	11	.75	19	4,000	27.6	5.75	146	28	.45	.68
950B-12	5/8	16	1.08	27	4,000	27.6	7.75	197	28	.96	1.43
950B-16	29/32	23	1.36	34	4,000	27.6	9.63	245	28	1.30	1.93

Construction

Tube: Black static-dissipative PTFE

Reinforcement: Multiple high density braids of 304 Stainless Steel

Fittings

95 Series – pg. E-90

Notes

Factory-made assemblies only

Operating Parameters

Temperature Range:

-65°F to +400°F (-54°C to +204°C)

Change in length at Max. Working Pressure: ±2%

Min. Burst Pressure is 3x Max. Working Pressure at 73°F (23°C)

955B – 5,500 psi W.P. High Temp Hose



Features

- High temperature hydraulic hose
- Excellent chemical compatibility
- Resists moisture
- Low friction minimizes pressure drops and deposits

Applications/Markets



- General Hydraulics
- Chemical Transfer
- Compressed Air/Gases
- Ground Support

Part Number	Nominal I.D.		Maximum O.D.		Maximum Working Pressure		Minimum Bend Radius		Vac. Rating Hg./73°F	Weight	
	inch	mm	inch	mm	psi	MPa	inch	mm		inch	lbs./ft.
#											
955B-4	15/64	6	.50	13	5,500	37.9	3.00	76	28	.23	.34
955B-6	5/16	8	.62	16	5,500	37.9	5.00	127	28	.24	.35
955B-8	7/16	11	.75	19	5,500	37.9	5.75	146	28	.46	.68
955B-10	1/2	13	.91	23	5,500	37.9	6.50	165	28	.91	1.34
955B-12	5/8	16	1.08	27	5,500	37.9	7.75	197	28	.92	1.36
955B-16	29/32	23	1.36	34	5,500	37.9	9.63	245	28	1.20	1.77

Construction

Tube: Black static-dissipative PTFE
 Reinforcement: Multiple high density braids of 304 Stainless Steel

Operating Parameters

Temperature Range:
 -65°F to +400°F (-54°C to +204°C)
 Change in length at Max. Working Pressure: ±2%
 Min. Burst Pressure is 16,000 psi at 73°F (23°C)

Fittings

95 Series – pg. E-90

Notes

Factory-made assemblies only
 Not suggested for steam-cold water cycling applications
 Reduce operating pressure to 4000 psi (27.6 MPa) for impulse service applications

For detailed ordering information, please consult price list or contact Parflex® Division.

Parker Hannifin Corporation | Parflex® Division | Ravenna, Ohio | parker.com/pfd

www.comoso.com



A-77

S30/S30B - Industrial .030" wall PTFE Hose, Stainless Steel Braid



Features

- High temperature hose
- Excellent chemical compatibility
- Resists moisture
- Low friction minimizes pressure drops and deposits

Compliances

- FDA 21 CFR 177.1550 (Natural tube)
- SAE J517 (100R14)

Applications/Markets



- Fluid Handling
- Chemical Transfer
- Paint
- Pharmaceutical
- Food & Beverage
- Cosmetics

Part Number		Nominal I.D.		Nominal O.D.		Maximum Working Pressure		Minimum Bend Radius		Vac. Rating Hg./73°F	Weight		Permanent Fitting Series	Field Attachable Series
#	#	⊙		⊙		↗		↘		U	lbs	kg	⊗	⊗
Natural	Conductive	inch	mm	inch	mm	psi	bar	inch	mm	inch	lbs./ft.	kg./mtr.		
03-S30	03-S30B	1/8	3	.250	6	3,000	207	1-1/2	38	28	.05	.08	91	-
04-S30	04-S30B	3/16	5	.305	8	3,000	207	2	51	28	.06	.09	91N	90
05-S30	05-S30B	1/4	6	.375	10	3,000	207	3	76	28	.11	.16	91N	90
06-S30	06-S30B	5/16	8	.430	11	2,500	172	4	102	28	.13	.20	91N	90
08-S30	08-S30B	13/32	10	.535	14	2,000	138	5	127	28	.15	.22	91N	90
10-S30	10-S30B	1/2	13	.636	16	1,750	121	6-1/2	165	28	.19	.28	91N	90
12-S30	12-S30B	5/8	16	.765	19	1,500	103	7-1/2	191	12	.24	.36	91N	90
16-S30	16-S30B	7/8	22	1.030	26	1,000	69	9	229	14	.31	.47	91N	90

Construction

Tube: S30 - Natural FDA Compliant PTFE
S30B - Black Static-Dissipative PTFE
Reinforcement: 304 Stainless Steel braid

Operating Parameters

Temperature Range:
-100°F to +450°F (-73°C to +232°C)
Change in length at Max. Working Pressure: +2% to -4%
Min. Burst Pressure is 4x Max. Working Pressure at 73°F (23°C)
All ratings based on 72°F/23°C

Fittings

90 Series - pg. E-65
91/91N Series - pg. E-72
For most Parker products, Crimp Die Selection charts can be found online at www.parker.com/crimpsource
Access instructions are on pg. G-13

Notes

See pg. A-20 for part numbering system

S40/S40B - Industrial .040 wall Heavy Wall PTFE Hose, Stainless Steel Braid



Features

- 33% more PTFE
- High temperature hose
- Excellent chemical compatibility
- Improved bend radius
- Decreased gas permeation
- Low friction minimizes pressure drops and deposits

Compliances

- FDA 21 CFR 177.1550 (Natural tube)
- SAE J517 (100R14)

Applications/Markets



- Fluid Handling
- Chemical Transfer
- Paint
- Pharmaceutical
- Food & Beverage
- Cosmetics

Part Number		Nominal I.D.		Nominal O.D.		Maximum Working Pressure		Minimum Bend Radius		Vac. Rating Hg./73°F	Weight		Permanent Fitting Series
#	#	⊙		⊙		↗		↘		U	lbs	kg	⊗
Natural	Conductive	inch	mm	inch	mm	psi	bar	inch	mm	inch	lbs./ft.	kg./mtr.	
04-S40	04-S40B	3/16	5	.320	8	3,000	207	2	51	28	.08	.13	91N
05-S40	05-S40B	1/4	6	.375	10	3,000	207	3	76	28	.11	.16	91N
06-S40	06-S40B	5/16	8	.435	11	2,500	172	4	102	28	.12	.18	91N
08-S40	08-S40B	13/32	10	.565	14	2,000	138	5	127	28	.16	.23	91N
10-S40	10-S40B	1/2	13	.656	17	1,750	121	6-1/2	165	28	.17	.25	91N
12-S40	12-S40B	5/8	16	.780	20	1,500	103	7-1/2	191	12	.19	.28	91N
16-S40	16-S40B	7/8	22	1.05	27	1,000	69	9	229	14	.49	.73	91N

Construction

Tube: S40 - Natural FDA Compliant PTFE
S40B - Black Static-Dissipative PTFE
Reinforcement: 304 Stainless Steel braid

Operating Parameters

Temperature Range:
-100°F to +450°F (-73°C to +232°C)
Change in length at Max. Working Pressure: +2% to -4%
Min. Burst Pressure is 4x Max. Working Pressure at 73°F (23°C)
All ratings based on 72°F/23°C

Fittings

91N Series - pg. E-72
For most Parker products, Crimp Die Selection charts can be found online at www.parker.com/crimpsource
Access instructions are on pg. G-13

Notes

See pg. A-20 for part numbering system

For detailed ordering information, please consult price list or contact Parflex® Division.

Parker Hannifin Corporation | Parflex® Division | Ravenna, Ohio | parker.com/pfd

www.comoso.com



STW/STB - "TRUE BORE"

Smoothbore PTFE Hose, Stainless Steel Braid



Features

- High temperature hose
- Excellent chemical compatibility
- Resists moisture
- Low friction minimizes pressure drops and deposits

Compliances

- FDA 21 CFR 177.1550
- USP Class VI
- ISO 10993 Sections 5, 6, 10, 11

Applications/Markets



- Fluid Handling
- Chemical Transfer
- Paint
- Pharmaceutical
- Food & Beverage
- Cosmetics

Part Number		Nominal I.D.		Nominal O.D.		Maximum Working Pressure 73°F/ 23°C		Minimum Bend Radius		Vac. Rating Hg./73°F	Weight		Permanent Fitting Series
#	#												
Natural	Conductive	inch	mm	inch	mm	psi	bar	inch	mm	inch	lbs./ft.	kg./mtr.	
04-STW	04-STB	1/4	6	.37	9	3,000	207	3	76	28	.08	.13	PAGE
06-STW	06-STB	3/8	10	.51	13	2,000	138	5	127	28	.11	.16	PAGE
08-STW	08-STB	1/2	13	.63	16	1,750	121	6-1/2	165	28	.16	.24	PAGE
12-STW	12-STB	3/4	19	.88	22	1,000	69	8.5	216	28	.20	.30	PAGE
16-STW	16-STB	1	25	1.13	29	1,000	69	12	305	20	.33	.49	PAGE
16Z-STW	16Z-STB	1	25	1.22	31	1,000	69	12	305	20	.56	.83	PAGE
20Z-STW	20Z-STB	1-1/4	32	1.52	38	1,000	69	14	356	18	.68	1.02	PAGE
24Z-STW	24Z-STB	1-1/2	38	1.73	44	900	62	15	381	15	.79	1.18	PAGE

Construction

Tube: STW - Natural FDA Compliant PTFE

STB - Black Static-Dissipative PTFE

Reinforcement: 304 Stainless Steel braid

Operating Parameters

Temperature Range:

-100°F to +450°F (-73°C to +232°C)

Change in length at Max. Working Pressure: +2% to -4%

Min. Burst Pressure is 4x Max. Working Pressure at 73°F (23°C)

All ratings based on 72°F/23°C

Fittings

PAGE Fittings – pg. E-91

Uses crimp collar ST300, see pg. E-92

For most Parker products, Crimp Die Selection charts can be found online at www.parker.com/crimpsource

Access instructions are on pg. G-13

Notes

"Z" indicates double braid

See pg. A-21 for part numbering system

Cannot be used with 90 or 91N series fittings

SBFW/SBFB - PAGE-flex® SBF

Extra Flexible Fluoropolymer Hose



Features

- Half the minimum bend radius of conventional smoothbore products
- Kink and vacuum resistant
- Easily cleaned
- PPIH full line of optional reinforcement types
- Cooler outside temperatures reduces operator burns
- Reduces environment temperatures in confined areas
- Available with white Silicone cover

Compliances

- FDA 21 CFR 177.1550
- **USP Class VI Certified**
- ISO 10993 Sections 5, 6, 10, 11

Applications/Markets



- Fluid Handling
- Chemical Transfer
- Paint
- Pharmaceutical
- Food & Beverage
- Cosmetics



Part Number		Nominal I.D.		Nominal O.D.		Maximum Working Pressure 73°F/ 23°C		Minimum Bend Radius		Vac. Rating Hg./73°F	Weight	
#	#	⊙		⊙		↗		↘		U	lbs	kg
Natural	Conductive	inch	mm	inch	mm	psi	bar	inch	mm	inch	lbs./ft.	kg./mtr.
06-SBFW	06-SBFB	3/8	10	.63	16	300	21	2	51	28	.16	.24
08-SBFW	08-SBFB	1/2	13	.76	19	300	21	2-1/2	64	28	.23	.34
12-SBFW	12-SBFB	3/4	19	1.04	26	250	17	3	76	28	.37	.55
16-SBFW	16-SBFB	1	25	1.29	33	250	17	4	102	28	.54	.80
24-SBFW	24-SBFB	1-1/2	38	1.85	47	200	14	7	178	28	.83	1.23

Construction

Tube: SBFW - Natural PFA tube

SBFB - Black Static-dissipative PFA tube

Reinforcement: bonded wire braid - silicone - textile braided composite with 316 Stainless Steel braid

Operating Parameters

Temperature Range:

-65°F to +325°F (-54°C to +163°C)

Min. Burst Pressure is 4x Max. Working Pressure at 73°F (23°C)

All ratings based on 72°F/23°C

Fittings

PAGE Fittings - pg. E-91

Complete line of standard PPIH crimp fittings

Notes

Factory-made assemblies only

SBFB - Special order only

Available with white silicone cover

See pg. A-21 for part numbering system

For detailed ordering information, please consult price list or contact Parflex® Division.

Parker Hannifin Corporation | Parflex® Division | Ravenna, Ohio | parker.com/pfd

www.comoso.com



SCW/SCB - Convoluted PTFE Hose

316 Stainless Steel Braid



Features

- High temperature hose
- Excellent corrosion resistance
- Seamless
- Open pitch
- Self draining
- Withstands extreme flexing
- Environmentally safe; low effusion
- Long life expectancy

Compliances

- FDA 21 CFR 177.1550
- USP Class VI
- ISO 10993 Sections 5, 6, 10, 11

Applications/Markets



- Fluid Handling
- Chemical Transfer
- Paint
- Semiconductor

Part Number		Nominal I.D.		Nominal O.D.		Maximum Working Pressure 73°F/ 23°C		Minimum Bend Radius		Vac. Rating Hg./73°F	Weight		Permanent Fitting Series
#	#												
Natural	Conductive	inch	mm	inch	mm	psi	bar	inch	mm	inch	lbs./ft.	kg./mtr.	
04-SCW	04-SCB	1/4	6	.46	12	1,500	104	3/4	19	28	.08	.11	PAGE
06-SCW	06-SCB	3/8	10	.54	14	1,500	104	1	25	28	.14	.21	PAGE
08-SCW	08-SCB	1/2	13	.72	18	1,500	104	1-1/2	38	28	.16	.23	PAGE
12-SCW	12-SCB	3/4	19	1.02	26	1,200	83	2	51	28	.27	.40	PAGE
16-SCW	16-SCB	1	25	1.31	33	1,000	69	2-1/2	64	28	.37	.55	PAGE
20-SCW	20-SCB	1-1/4	32	1.73	44	750	52	3	76	28	.46	.68	PAGE
24-SCW	24-SCB	1-1/2	38	1.93	49	650	45	3-3/4	95	28	.55	.81	PAGE
32-SCW	32-SCB	2	51	2.42	62	450	31	4-3/4	121	28	.90	1.4	PAGE

Construction

Tube: SCW - Natural FDA Compliant PTFE

SCB - Black Static-Dissipative PTFE

Reinforcement: 316 Stainless Steel braid

Operating Parameters

Temperature Range:

-100°F to +500°F (-73°C to +260°C)

Min. Burst Pressure is 4x Max. Working Pressure at 73°F (23°C)

All ratings based on 72°F/23°C

Fittings

PAGE Fittings - pg. E-91

Uses crimp collar SC300, see pg. E-92

For most Parker products, Crimp Die Selection charts can be found online at www.parker.com/crimpsource

Access instructions are on pg. G-13

Notes

Not suggested for steam-cold water cycling applications

See pg. A-21 for part numbering system

Cannot be used with 90 or 91N series fittings

PCW/PCB - Convoluted PTFE Hose

Polypropylene Braid



Features

- Personal handling safety
- Excellent corrosion resistance
- Seamless
- Open pitch
- Self draining
- Withstands extreme flexing
- Environmentally safe; low effusion
- Long life expectancy

Compliances

- FDA 21 CFR 177.1550
- USP Class VI
- ISO 10993 Sections 5, 6, 10, 11

Applications/Markets



- Fluid Handling
- Chemical Transfer
- Paint
- Pharmaceutical
- Food & Beverage

Part Number		Nominal I.D.		Nominal O.D.		Maximum Working Pressure 73°F/ 23°C		Minimum Bend Radius		Vac. Rating Hg./73°F	Weight		Permanent Fitting Series
#	#												
Natural	Conductive	inch	mm	inch	mm	psi	bar	inch	mm	inch	lbs./ft.	kg./mtr.	
04-PCW	04-PCB	1/4	6	.55	14	350	59	3/4	19	28	.03	.05	PAGE
06-PCW	06-PCB	3/8	10	.64	16	350	59	1	25	28	.06	.09	PAGE
08-PCW	08-PCB	1/2	13	.84	21	300	21	1-1/2	38	28	.15	.22	PAGE
12-PCW	12-PCB	3/4	19	1.15	29	250	17	2	51	28	.18	.27	PAGE
16-PCW	16-PCB	1	25	1.50	38	250	17	2-1/2	64	28	.26	.39	PAGE
20-PCW	20-PCB	1-1/4	32	1.92	49	200	14	3	76	28	.37	.55	PAGE
24-PCW	24-PCB	1-1/2	38	2.12	54	200	14	3-3/4	95	28	.42	.63	PAGE
32-PCW	32-PCB	2	51	2.65	67	200	14	4-3/4	121	28	.56	.83	PAGE

Construction

Tube: PCW - Natural FDA Compliant PTFE

PCB - Black Static-Dissipative PTFE

Reinforcement: Polypropylene

Operating Parameters

Temperature Range:

0°F to +212°F (-18°C to +100°C)

Min. Burst Pressure is 4x Max. Working Pressure at 73°F (23°C)

All ratings based on 72°F/23°C

Fittings

PAGE Fittings - pg. E-91

Uses crimp collar PC300, see pg. E-92

For most Parker products, Crimp Die Selection charts can be found online at www.parker.com/crimpsource

Access instructions are on pg. G-13

Notes

Not suggested for steam-cold water cycling applications

See pg. A-21 for part numbering system

Cannot be used with 90 or 91N series fittings

For detailed ordering information, please consult price list or contact Parflex® Division.

Parker Hannifin Corporation | Parflex® Division | Ravenna, Ohio | parker.com/pfd

www.comoso.com



A-83

SCWV/SCBV

Stainless Steel Braid, Heavy Wall Convoluted PTFE Hose



Features

- High temperature hose
- Open pitch
- Thicker wall
- Handles vacuum applications at elevated temperatures
- Excellent chemical compatibility
- Easy Cleaning
- Non Adhesive

Compliances

- FDA 21 CFR 177.1550
- USP Class VI
- ISO 10993 Sections 5, 6, 10, 11

Applications/Markets



- Fluid Handling
- Chemical Transfer
- Paint
- Semiconductor

Part Number		Nominal I.D.		Nominal O.D.		Maximum Working Pressure 73°F/ 23°C		Minimum Bend Radius		Vac. Rating Hg./73°F	Weight	
#	#											
Natural	Conductive	inch	mm	inch	mm	psi	bar	inch	mm	inch	lbs./ft.	kg./mtr.
08-SCWV	08-SCBV	1/2	13	.75	19	1,500	104	2	51	28	.17	.26
12-SCWV	12-SCBV	3/4	19	1.04	26	1,200	83	2-3/4	70	28	.33	.49
16-SCWV	16-SCBV	1	25	1.25	32	1,000	69	4	102	28	.37	.55
20-SCWV	20-SCBV	1-1/4	32	1.66	42	750	52	5-1/2	140	28	.56	.83
24-SCWV	24-SCBV	1-1/2	38	1.92	49	650	45	7	178	28	.64	.95
32-SCWV	32-SCBV	2	51	2.49	63	450	31	8-1/2	216	28	.84	1.24
40-SCWV	40-SCBV	2-1/2	64	3.25	83	200	14	12	305	28	1.52	2.26
48-SCWV	48-SCBV	3	76	3.80	97	175	12	14	356	28	1.82	2.71
64-SCWV	64-SCBV	4	102	4.76	121	150	10	16	406	28	2.10	3.13

Construction

Tube: SCWV - Heavy Wall Natural FDA Compliant PTFE

SCBV - Heavy Wall Black Static-dissipative PTFE

Reinforcement: 316 Stainless Steel braid

Operating Parameters

Temperature Range:

-100°F to +500°F (-73°C to +260°C)

Min. Burst Pressure is 4x Max. Working Pressure at 73°F(23°C)

All ratings based on 72°F/23°C

Fittings

PAGE Fittings – pg. E-91

Notes

Factory-made assemblies only

Not suggested for steam-cold water cycling applications

See pg. A-21 for part numbering system

Cannot be used with 90 or 91N series fittings

Vacuum wire recommended for 2-1/2, 3 and 4 inch



PCWV/PCBV

Polypropylene Braid, Heavy Wall Convoluted PTFE Hose



Features

- Personal handling safety
- Open pitch
- Thicker wall
- Handles vacuum applications at elevated temperatures
- Excellent chemical compatibility
- Easy Cleaning
- Non Adhesive

Compliances

- FDA 21 CFR 177.1550
- USP Class VI
- ISO 10993 Sections 5, 6, 10, 11

Applications/Markets



- Fluid Handling
- Chemical Transfer
- Paint
- Pharmaceutical
- Food & Beverage

Part Number		Nominal I.D.		Nominal O.D.		Maximum Working Pressure 73°F/ 23°C		Minimum Bend Radius		Vac. Rating Hg./73°F	Weight	
#	#											
Natural	Conductive	inch	mm	inch	mm	psi	bar	inch	mm	inch	lbs./ft.	kg./mtr.
08-PCWV	08-PCBV	1/2	13	.81	21	300	21	3	76	28	.14	.20
12-PCWV	12-PCBV	3/4	19	1.30	33	250	17	3-1/2	89	28	.22	.32
16-PCWV	16-PCBV	1	25	1.44	36	250	17	4-1/2	114	28	.32	.47
20-PCWV	20-PCBV	1-1/4	32	1.86	47	200	14	5	127	28	.40	.59
24-PCWV	24-PCBV	1-1/2	38	2.10	53	200	14	6	152	28	.49	.73
32-PCWV	32-PCBV	2	51	2.66	68	200	14	8-1/2	216	28	.66	.99
40-PCWV	40-PCBV	2-1/2	64	3.57	91	150	10	12	305	28	1.21	1.80
48-PCWV	48-PCBV	3	76	3.92	100	125	9	14	356	28	1.45	2.16
64-PCWV	64-PCBV	4	102	4.92	125	100	7	16	406	28	1.68	2.50

Construction

Tube: PCWV - Heavy Wall Natural FDA Compliant PTFE

PCBV - Heavy Wall Black Static-dissipative PTFE

Reinforcement: Polypropylene

Operating Parameters

Temperature Range:

0°F to +212°F (-18°C to +100°C)

Min. Burst Pressure is 4x Max. Working Pressure at 73°F (23°C)

All ratings based on 72°F/23°C

Fittings

PAGE Fittings - pg. E-91

Notes

Factory-made assemblies only

Not suggested for steam-cold water cycling applications

See pg. A-21 for part numbering system

Cannot be used with 90 or 91N series fittings

Vacuum wire recommended for 2-1/2, 3 and 4 inch

For detailed ordering information, please consult price list or contact Parflex® Division.

Parker Hannifin Corporation | Parflex® Division | Ravenna, Ohio | parker.com/pfd

www.comoso.com



A-85

A Hose
 B Tubing
 C Coiled Air Hose & Fittings
 D Transportation
 E Fittings
 F Tooling, Equipment & Accessories
 G General Technical

SCWV-FS/SCBV-FS - Flare-Seal®

Stainless Steel Braid



Features

- Flare Seal fitting - Continuous PTFE through fitting; no area for bacterial entrapment
- Increased flow
- Thicker wall
- Excellent chemical compatibility
- Easy Cleaning
- Non Adhesive

Compliances

- FDA 21 CFR 177.1550
- USP Class VI
- ISO 10993 Sections 5, 6, 10, 11

Applications/Markets



- Fluid Handling
- Chemical Transfer
- Paint
- Pharmaceutical
- Food & Beverage

Part Number		Nominal I.D.		Nominal O.D.		Maximum Working Pressure 73°F/ 23°C		Minimum Bend Radius		Vac. Rating Hg./73°F	Weight	
#	#											
Natural	Conductive	inch	mm	inch	mm	psi	bar	inch	mm	inch	lbs./ft.	kg./mtr.
08-SCWV-FS	08-SCBV-FS	1/2	13	.75	19	500	35	2	51	28	.17	.26
12-SCWV-FS	12-SCBV-FS	3/4	19	1.04	26	425	29	2-3/4	70	28	.33	.49
16-SCWV-FS	16-SCBV-FS	1	25	1.25	32	350	24	4	102	28	.37	.55
20-SCWV-FS	20-SCBV-FS	1-1/4	32	1.66	42	325	22	5-1/2	140	28	.56	.83
24-SCWV-FS	24-SCBV-FS	1-1/2	38	1.92	49	300	21	7	178	28	.64	.95
32-SCWV-FS	32-SCBV-FS	2	51	2.49	63	250	17	8-1/2	216	28	.84	1.24
40-SCWV-FS	40-SCBV-FS	2-1/2	64	3.25	83	200	14	12	305	28	1.52	2.26
48-SCWV-FS	48-SCBV-FS	3	76	3.80	97	175	12	14	356	28	1.82	2.71
64-SCWV-FS	64-SCBV-FS	4	102	4.76	121	150	10	16	406	28	2.10	3.13

Construction

Tube: SCWV -FS- Heavy Wall Natural FDA Compliant PTFE

SCBV-FS - Heavy Wall Black Static-dissipative PTFE

Reinforcement: 316 Stainless Steel braid

Operating Parameters

Temperature Range:

-100°F to +500°F (-73°C to +260°C)

Min. Burst Pressure is 4x Max. Working Pressure at 73°F (23°C)

All ratings based on 73°F/23°C

Fittings

PAGE Fittings – pg. E-91

Notes

Factory-made assemblies only

Not suggested for steam-cold water cycling applications

All dimensions nominal

See pg. A-21 for part numbering system

Cannot be used with 90 or 91N series fittings

PCWV-FS/PCBV-FS - Flare-Seal® Polypropylene Braid



Features

- Flare Seal fitting - Continuous PTFE through fitting; no area for bacterial entrapment
- Increased flow
- Personal handling safety
- Good chemical compatibility
- Easy Cleaning
- Non Adhesive

Compliances

- FDA 21 CFR 177.1550
- USP Class VI
- ISO 10993 Sections 5, 6, 10, 11

Applications/Markets



- Fluid Handling
- Chemical Transfer
- Paint
- Pharmaceutical
- Food & Beverage

Part Number		Nominal I.D.		Nominal O.D.		Maximum Working Pressure 73°F/ 23°C		Minimum Bend Radius		Vac. Rating Hg./73°F	Weight	
#	#											
Natural	Conductive	inch	mm	inch	mm	psi	bar	inch	mm	inch	lbs./ft.	kg./mtr.
08-PCWV-FS	08-PCBV-FS	1/2	13	.810	21	300	21	3	76	28	.14	.20
12-PCWV-FS	12-PCBV-FS	3/4	19	1.10	28	250	17	3-1/2	89	28	.22	.32
16-PCWV-FS	16-PCBV-FS	1	25	1.44	36	250	17	4-1/2	114	28	.31	.47
20-PCWV-FS	20-PCBV-FS	1-1/4	32	1.86	47	200	14	5	127	28	.40	.59
24-PCWV-FS	24-PCBV-FS	1-1/2	38	2.10	53	200	14	6	152	28	.49	.73
32-PCWV-FS	32-PCBV-FS	2	51	2.66	68	200	14	8-1/2	216	28	.66	.99
40-PCWV-FS	40-PCBV-FS	2-1/2	64	3.42	87	150	10	12	305	28	1.21	1.80
48-PCWV-FS	48-PCBV-FS	3	76	3.92	100	125	9	14	356	28	1.45	2.16
64-PCWV-FS	64-PCBV-FS	4	102	4.92	125	100	7	16	406	28	1.68	2.50

Construction

Tube: PCWV-FS - Heavy Wall Natural FDA Compliant PTFE

PCBV-FS- Heavy Wall Black Static-dissipative PTFE

Reinforcement: Polypropylene

Operating Parameters

Temperature Range:

0°F to +212°F (-18°C to +100°C)

Min. Burst Pressure is 4x Max. Working Pressure at 73°F (23°C)

All ratings based on 73°F/23°C

Fittings

PAGE Fittings - pg. E-91

Notes

Factory-made assemblies only

Not suggested for steam-cold water cycling applications

See pg. A-21 for part numbering system

Cannot be used with 90 or 91N series fittings

For detailed ordering information, please consult price list or contact Parflex® Division.

Parker Hannifin Corporation | Parflex® Division | Ravenna, Ohio | parker.com/pfd

www.comoso.com



A-87

Hose
A

Tubing
B

Coiled Air Hose
& Fittings
C

Transportation
D

Fittings
E

Tooling, Equipment
& Accessories
F

General Technical
G

RCTW/RCTB EPDM Rubber Covered Fluoropolymer Hose



Features

- Personal handling safety
- Handles full vacuum
- Good chemical compatibility
- Easy Cleaning
- Non Adhesive

Compliances

- FDA 21 CFR 177.1550 (FEP core)
- **USP Class VI Certified**
- ISO 10993 Sections 5, 6, 10, 11

Applications/Markets



- Food & Beverage
- Pharmaceutical
- Fluid Handling
- Chemical
- Ground Support
- Industrial
- Paint
- Semiconductor

Part Number		Nominal I.D.		Nominal O.D.		Maximum Working Pressure 73°F/ 23°C		Minimum Bend Radius		Vac. Rating Hg./73°F	Weight		Permanent Fitting Series
#	#												
Natural	Conductive	inch	mm	inch	mm	psi	bar	inch	mm	inch	lbs./ft.	kg./mtr.	
08-RCTW	08-RCTB	1/2	13	.95	24	500	35	2-1/2	64	30	.33	.49	PAGE
12-RCTW	12-RCTB	3/4	19	1.25	32	500	35	3	76	30	.51	.76	PAGE
16-RCTW	16-RCTB	1	25	1.53	39	450	31	4	102	30	.67	1.00	PAGE
20-RCTW	20-RCTB	1-1/4	32	1.74	44	375	26	7	178	30	.72	1.07	PAGE
24-RCTW	24-RCTB	1-1/2	38	2.13	54	375	26	9	229	30	1.10	1.51	PAGE
32-RCTW	32-RCTB	2	51	2.68	68	300	21	10-1/2	267	30	1.54	2.30	PAGE
40-RCTW	40-RCTB	2-1/2	64	3.30	84	200	14	15	381	30	2.07	3.09	PAGE
48-RCTW	48-RCTB	3	76	3.88	99	200	14	18	457	30	2.99	4.46	PAGE
64-RCTW	64-RCTB	4	102	4.98	127	150	10	22-1/2	572	30	4.33	6.46	PAGE

Construction

Tube: RCTW - Natural FEP tube

RCTB - Static-dissipative PFA tube

Reinforcement: Double wire helix - multi layered rubber

Cover: Textile reinforced EPDM

Operating Parameters

Temperature Range:

-40°F to +300°F (-40°C to +149°C) Decrease working pressure one percent for every 2°F above 212°F.

Operating pressures shown are for non-impulse service

All ratings based on 73°F/23°C

Fittings

PAGE Fittings - pg. E-91

Uses crimp collar RC300, see pg. E-92

For most Parker products, Crimp Die Selection charts can be found online at www.parker.com/crimpsource

Access instructions are on pg. G-13

Notes

RCTB - Special order only

See pg. A-21 for part numbering system

Cannot be used with 90 or 91N series fittings

Tubing

Thermoplastic

Polyethylene

Nylon

Parprene™ TPE

Polypropylene

Polyurethane

Clear Vinyl

Fluoropolymer

PTFE

FEP

PFA

PVDF

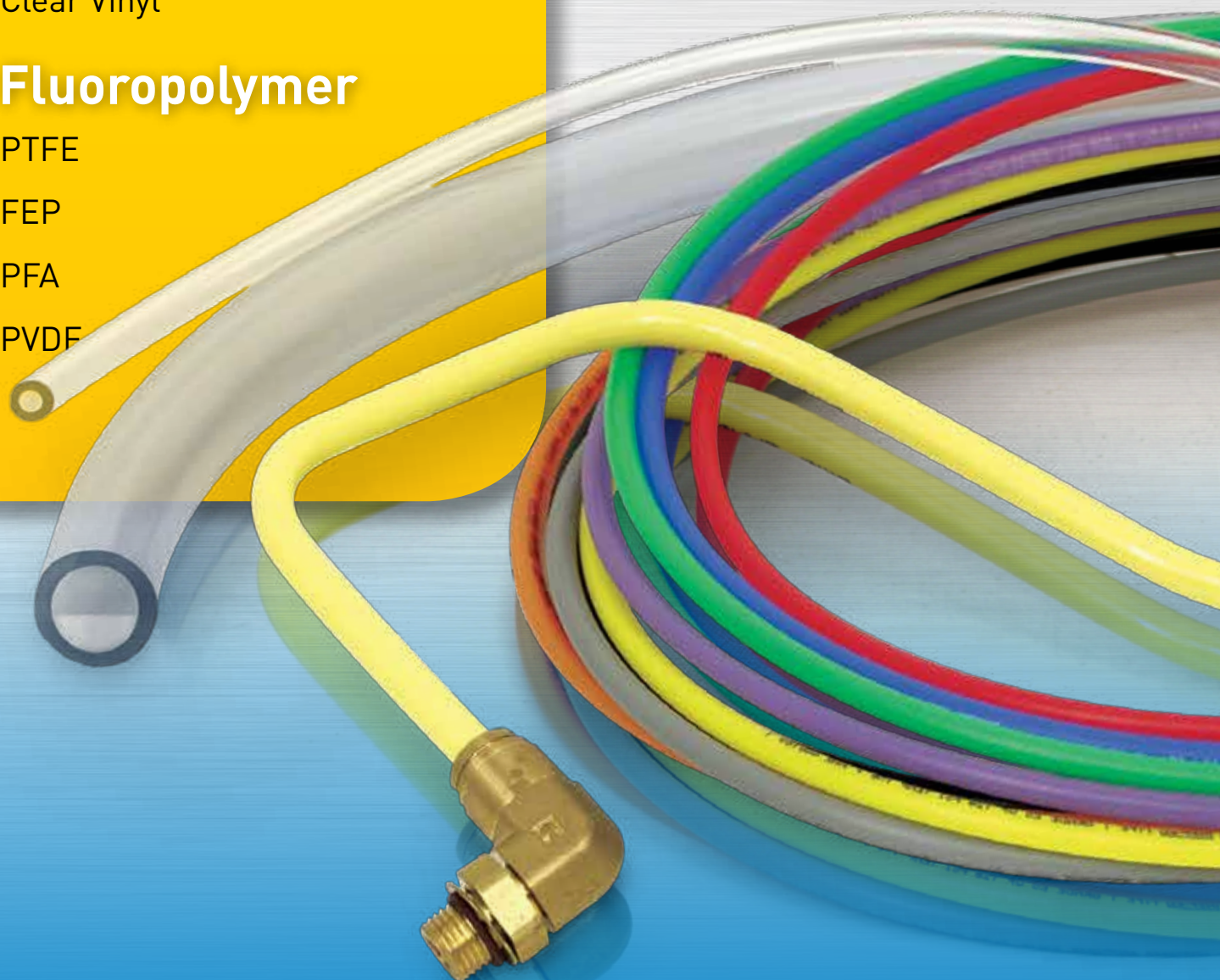

Table of Contents

Thermoplastic Tubing

Introduction

Intro	B-4 : B-9
Tubing Compatibility Chart Material Overview	B-6

Polyethylene Tubing

Fractional – Series E/EB	B-10
Metric – Series E/EB	B-12
Flame Resistant – Series PEFR	B-14
High Density – Series HDPE	B-16

Nylon Tubing

Fractional – Series N/NB	B-18
Metric – Series N/NB	B-20
Pure Air Tubing – Series PAT	B-22
Semi-rigid Tubing – Series NR	B-24
Series NTNA	B-26

Parprene™ Tubing

General Industrial – Series G:	B-28
Food & Dairy – Series F:	B-30

Polypropylene Tubing

Laboratory Grade – Series PP/PPB	B-32
--	------

Polyurethane Tubing

Fractional Polyether Base – Series U	B-34
Metric Polyether Base – Series UM	B-36
HUFR MicroWeld™ – Series HUFR	B-38
Fractional – Series HU	B-40
Metric – Series HUM	B-42

Clear Vinyl Tubing

Clear Vinyl Tubing – Series PV	B-44
--------------------------------------	------

Fluoropolymer Tubing

Introduction

Intro	B-48
Material Overview.....	B-50
Fluoropolymer Nomenclature.....	B-52

PTFE Tubing

Fractional – Series 101	B-54
Metric – Series 201.....	B-57
Fractional – Series TFS, TFT, TFL.....	B-58
AWG – Series TFH, TFS, TFT, TFL	B-60
Beading - Series TFB	B-65
Spiral Cut Cable Wrap, TSWTF.....	B-66
PTFE Fractional Heat Shrink - Series HS2TFS, HS2TFT, HS2TFL, HS2TFI	B-68
PTFE AWG 2:1 Heat Shrink - Series HS2TFS, HS2TFT, HS2TFL	B-70
PTFE AWG 4:1 Heat Shrink - Series HS4TFI	B-74
Convolute, Convo-Tex® - Series CV.....	B-76
Low Profile, Heavy Wall - Series CVL, CVH	B-79
SAE AS81914/1 and 2 - Series 81914	B-80

FEP Tubing

Fractional – Series 103.....	B-82
Metric – Series 203.....	B-83
FEP 1.3:1 Heat Shrink - Series HS1.3FEP	B-84
FEP 1.67:1 Heat Shrink - Series HS1.67FEP	B-86
FEP Roll Cover - Series HS1.25FEP	B-88
FEP/PTFE Double Shrink - Series TSSS, TSSL	B-89
Convolute- Series CV03, Convo-Flon™	B-90
SAE AS81914/3 and 4 - Series 81914	B-92
Corrugated - Series CR03.....	B-94
Retractable Coiled Tubing- Series 703.....	B-96

PFA Tubing

Fractional – Series 104.....	B-98
Metric – Series 204.....	B-99

High Purity PFA Tubing

Fractional – Series 105.....	B-100
Metric – Series 205.....	B-101

PVDF Tubing

Flex™– Series 110.....	B-102
Super-Flex® – Series 111	B-103

For detailed ordering information, please consult price list or contact Parflex® Division.

Parker Hannifin Corporation | Parflex® Division | Ravenna, Ohio | parker.com/pfd

www.comoso.com



Parflex Tubing Introduction

Parflex New, Tubing Product

Parflex has expanded the tubing line to include:



Parprene TPE, a thermoplastic elastomer formulated to withstand the rigors of peristaltic pump applications and yet, be safe enough for food and beverage applications. pgs. B-28 : B-31



Convoluted tubing for applications where flexibility is needed. Available in PTFE, FEP and PFA materials. pgs. B-76 : B-80, B-90 : B-92



FEP Roll Cover, a protective sleeve for rollers used with ink or in paper mills. pg. B-88



Corrugated tubing is the most flexible tubing available and is capable of turning sharp corners without reducing the inside diameter of the tube. Available in FEP and PFA. pg. B-94



Double Shrink Heat Shrink protects cables and other objects by totally encapsulating the parts as the FEP melts during the PTFE shrinking process. pg. B-89



Fluoroplastic coiled tubing is a spiral formed tube, consisting of a single or double retractable coil in a single tube. Available in FEP and PFA. pg. B-96

Parflex Tubing Tutorial

- Review the general attributes of Parflex thermoplastic and fluoropolymer tubing – this provides an excellent overview for the tubing product line.
- Review the application symbols - this will help you clear up any questions you may have on the product tables within the section. The market/applications table identifies and provides a “good fit” summary.
- Review the pressure bar graph - provides relative pressure ratings for the entire line of thermoplastic tubing. For fluoropolymer tubing, please contact Customer Service.
- Review the STAMPED guide (Size, Temperature, Media, Application, Pressure, End Configuration, and Delivery Preferences) on pg. 11 to help narrow your search for the desired product.
- Specific nomenclature, features, advantages and benefits can be found at the beginning page of each product line.
- Text appears in 2 colors. The primary dimensions are in black. As a courtesy, the metric/inch equivalent has been added and appears in blue.

Tubing Introduction

Tube Line Fabrication Guide for Leak Free Systems

Every hydraulic, pneumatic and lubrication system requires some form of tube line fabrication and fitting installation for completion. Proper fabrication and installation are essential for the overall efficiency, leak free performance and general appearance of any system.

Start by planning ahead. After sizing the tube lines and selecting the appropriate style of fitting, consider the following in the design of your system:

- Accessibility of joints
- Proper routing of lines
- Adequate tube line supports
- Available fabricating tools

Routing of Lines

Routing of lines is probably the most difficult, yet most significant, of these system design considerations. Proper routing involves getting a connecting line from one point to another through the most logical path.

Always try to leave fitting joints as accessible as possible. Hard to reach joints are hard to assemble and tighten properly. Inaccessible joints are also more difficult and time consuming to service.

Applications/Markets



Fluid Handling



Construction



Transportation



Industrial Pneumatic



Electrical



Military



General Industrial



Compressed Gas



Medical



Semiconductor



Food & Beverage



Pharmaceutical

For detailed ordering information, please consult price list or contact Parflex® Division.

Parker Hannifin Corporation | Parflex® Division | Ravenna, Ohio | parker.com/pfd

www.comoso.com



B-5

B Tubing

C Coiled Air Hose & Fittings

D Transportation

E Fittings

F Tooling, Equipment & Accessories

G General Technical

Parflex Tubing Introduction

Tubing Compatibility Chart

Parker Tubing / Hose Capability with Parker FSC Fittings

Product Sizes (inch)		Parflex Thermoplastic Tubing										
		Industrial Tubing Series (Outside Diameter Shown)								Industrial Tubing Series (O.D. shown)		
		Polyethylene E & EB Inch (4,5,6,8,10) Metric (6,8,10,12)	Polyethylene PE Inch (2,2.5,3,4,5,6,8)	Polyethylene PEFR Inch (2.5,4,6,8)	Polyethylene HDPE Inch (4,6)	Nylon N Inch (2,2.5,3,4,5,6,8) Metric (4mm - 20mm)	Nylon PAT Inch (2,4,6,8,10,12)	Nylon NR Inch (2,3,4,5,6,8)	Polypropylene PP & PPB Inch (2,3,4,5,6,8,10)	Polyurethane U (90 - 95 Shore A) Inch (2,3,4,6,8,9,12) Metric (4,6,8,10,12)	Polyurethane HU & HUM (>95 Shore A) Inch (2,2.5,4,6,8,12) Metric (4,6,8,10,12)	Polyurethane FR (Weld Tubing) Inch (4,5,6,8)
C Coiled Air Hose & Fittings	Compression - Inch (2,3,4,5,6,7,8,10,12,14)	PS TS	PS TS	PS TS	PS TS	PS TS	PS TS	PS TS				
	Compress-Align - Inch (2,3,4,5,6,8,10,12,14,16)	TS	TS	TS	TS	TS	TS	TS				
	Metru-Lok - Metric (4,6,8,10,12,14,16,18,22)	TS	TS									
	Poly-Tite - Inch (2,3,4,5,6,8)					BS		BS				
	Hi-Duty - Inch (2,3,4,5,6,8,10)	TS	TS	TS	TS	TS	TS	TS				
	45 degree flare - Inch (2,3,4,5,6,8,10,12,14)											
	Inverted Flare - Inch (2,3,4,5,6,8,10,12,14)											
D Transportation	Fast & Tite - Inch (4,5,6,8,10)								TS	TS		TS
	Flow Controls - Inch (2,2.5,4,5,6,8) Metric (4,6,8,10,12)											
	Prestolok Brass - Inch (2,2.5,3,4,5,6,8) Metric (4,5,6,8,10,12,14)											
	Prestolok Composite Inch (2,2.5,3,4,5,6,8) Metric (4,5,6,8,10,12,14)											
	Liquifit - Inch (4,6,8)											
	TrueSeal - Inch (4,5,6,8)								TS	TS		TS
	Par-Barb - Inch (2,3,4,5,6,8,10,12)								CL			CL
E Fittings	Dubl-Barb - Inch (2.5,4,6,8)											
	Hose Barb - Inch (2,3,4,5,6,8,10,12,16) Inside Diameter											CL
	Garden Hose											CL
	NTA - Inch (3,4,6,8,10,12)											
F Tooling, Equipment & Accessories	Transmission Fittings - Inch (2,2.5)											
	Air Brake - Inch (4,6,8,10,12,16)											
	Air Brake Hose - Inch (6,8)											
	Vibra-Lok - Inch (2,3,4,5,6,8,10,12)											
	Prestomatic - Inch (2,2.5,3,4,6,8,10,12) Metric (6,8,10,12,16)											
	PTC - Inch (4,6,8,10,12)											
	SAE Cartridges - Inch (2,5,4,6,8,10,12)											
	Manifolds - Inch (4,6,8)											

PS = Plastic sleeve & tube support recommended
 TS = Tube support is recommended
 BS = Brass sleeve recommended
 CL = Clamp required



For detailed ordering information, please consult price list or contact Parflex® Division.

Parker Hannifin Corporation | Parflex® Division | Ravenna, Ohio | parker.com/pfd

www.comoso.com

Parflex Thermoplastic Tubing				Parflex Fluoropolymer Tubing				Product Sizes (inch)	
Transportation Tubing				PFA Fluoropolymer Inch (3/32" - 1") Metric (4mm - 12mm)	FEP Fluoropolymer Inch (1/8" - 1") Metric (3mm - 12mm)	PTFE Fluoropolymer Inch (3/32" - 1") Metric (3mm - 16mm)	PVDF Fluoropolymer Inch (2,3,4,5,6,8,10,12,16)		
PFT Air Brake (SAE J844) Inch (2,2.5,3,4,5,6,8,10,12)	Air Brake DIN 74324 (Nylon 12) Metric (4,6,8,10,12,15,16,18)	PFT Diesel Fuel Sizes 4,6,8,10,12	HTFL Diesel Fuel Sizes 4,6,8,10,12						
				PS	PS	PS		Compression - Inch (2,3,4,5,6,7,8,10,12,14)	Compression & Flare
				TS	TS	TS		Compress-Align - Inch (2,3,4,5,6,8,10,12,14,16)	
								Metru-Lok - Metric (4,6,8,10,12,14,16,18,22)	
								Poly-Tite - Inch (2,3,4,5,6,8)	
								Hi-Duty - Inch (2,3,4,5,6,8,10)	
								45 degree flare - Inch (2,3,4,5,6,8,10,12,14)	
								Inverted Flare - Inch (2,3,4,5,6,8,10,12,14)	
								Fast & Tite - Inch (4,5,6,8,10)	Push-to-Connect
								Flow Controls - Inch (2,2.5,4,5,6,8) Metric (4,6,8,10,12)	
								Prestolok Brass - Inch (2,2.5,3,4,5,6,8) Metric (4,5,6,8,10,12,14)	
								Prestolok Composite Inch (2,2.5,3,4,5,6,8) Metric (4,5,6,8,10,12,14)	
								Liquifit - Inch (4,6,8)	Barb
								TrueSeal - Inch (4,5,6,8)	
								Par-Barb - Inch (2,3,4,5,6,8,10,12)	
								Dubl-Barb - Inch (2.5,4,6,8)	DOT Transportation
								Hose Barb - Inch (2,3,4,5,6,8,10,12,16) Inside Diameter	
								Garden Hose	
								NTA - Inch (3,4,6,8,10,12)	
								Transmission Fittings - Inch (2,2.5)	
								Air Brake - Inch (4,6,8,10,12,16)	
								Air Brake Hose - Inch (6,8)	
								Vibra-Lok - Inch (2,3,4,5,6,8,10,12)	
								Prestomatic - Inch (2,2.5,3,4,6,8,10,12) Metric (6,8,10,12,16)	
								PTC - Inch (4,6,8,10,12)	
								SAE Cartridges - Inch (2.5,4,6,8,10,12)	
								Manifolds - Inch (4,6,8)	

Tube Line Fabrication Guide for Leak Free Systems

Every hydraulic, pneumatic and lubrication system requires some form of tube line fabrication and fitting installation for completion. Proper fabrication and installation are essential for the overall efficiency, leak free performance, and general appearance of any system.

Start by planning ahead. After sizing the tube lines and selecting the appropriate style of fitting, consider the following in the design of your system:

1. Accessibility of joints
2. Proper routing of lines
3. Adequate tube line supports
4. Available fabricating tools

PS = Plastic sleeve & tube support recommended
 TS = Tube support is recommended
 BS = Brass sleeve recommended
 CL = Clamp required

For detailed ordering information, please consult price list or contact Parflex® Division.

Parker Hannifin Corporation | Parflex® Division | Ravenna, Ohio | parker.com/pfd

www.comoso.com



Thermoplastic Tubing

Tubing
Thermoplastic
B

Polyethylene

- Parflex polyethylene tubing meets FDA, NSF Standard 51 for all food contact applications and NSF-61 for potable water applications.
- E-Series tubing is made of 100% virgin resin material.
- Polyethylene tubing meets ASTM D-1693 (10% IGEPAL) for stress crack resistance.
- Parflex also offers special PE tubing: PEFR (flame retardant) and HDPE (high density).

Nylon

- Flexible nylon tubing is constructed of high-grade resins for strength and flexibility for routing in tight spaces.
- Semi-rigid high strength nylon is constructed of high-grade resins without the addition of plasticizers for higher pressure tubing applications.
- Pure Air Tubing (PAT) is the tubing choice for pure air systems (semiconductor) due to its cleanliness; in addition, it offers excellent chemical and UV light resistance.
- NTNA Tubing meets NSF Standard 51 for all food contact applications and may be used for instrumentation lines, lubrication and process piping systems and oil and refrigerant lines.

Coiled Air Hose
& Fittings
C

Parprene™ (thermoplastic elastomer)

- Excellent flexural fatigue resistance.
- Resistant to environmental stress cracking.
- Series F meets FDA, NSF Standard 51 and 3-A approved for all food contact applications.

Transportation
D

Polypropylene

- Polypropylene tubing meets FDA, NSF Standard 51 for all food contact applications.
- Polypropylene tubing exhibits excellent chemical resistance to chlorinated water applications.
- Black Polypropylene tubing is commonly used in outdoor applications where UV light stabilization is required.

Fittings
E

Polyurethane

- Polyurethane tubing is a flexible, kink-resistant and abrasion-resistant material commonly used in pneumatic applications.
- Polyurethane is available in multiple transparent and opaque colors for system color coding.
- Polyurethane is available in the following durometers (measurement of material hardness):
 - Medium durometer: (90 - 95)
 - High durometer: (>95) for higher pressures

Tooling, Equipment
& Accessories
F

Polyvinyl Chloride (PVC)

- PVC tubing is made from 100% virgin resin material and meets all FDA specifications for materials in contact with food and drugs.
- PVC tubing is a very flexible, 70 durometer tubing. It is crystal-clear and ideal for situations where visible fluid flow is necessary (i.e. sight gauges for tank identification).

**All plastic tubing dimensions are laser monitored to ensure overall quality product.
Most tubing sizes are packaged in convenient 100-ft., 250-ft., 500-ft. and 1,000-ft. lengths.**

General Technical
G

B-8



For detailed ordering information, please consult price list or contact Parflex® Division.

Parker Hannifin Corporation | Parflex® Division | Ravenna, Ohio | parker.com/pfd

www.comoso.com

Thermoplastic Tubing

Typical Applications

Product Family	Series	Suggested Markets and Applications
Polyethylene	E and EB	Potable water, chemical transfer, and low-cost, low-pressure pneumatics, NSF-51 & NSF- 61
	PEFR	Pneumatic controls in HVAC
	HDPE	Chemical transfer and low-cost pneumatics
Nylon	N	Pneumatic and petroleum-based chemical transfer
	PAT	Pure air and gas distribution systems, semiconductor
	NR	High pressure pneumatic, low pressure lubrication and hydraulic, marine control systems
	NTNA	Instrumentation lines, lubrication and process piping systems, oil and refrigerant lines, NSF-51
Polypropylene	PP and PPB	Food contact and chemical transfer applications, chlorinated water, NSF-51
Urethane	U and UM	Pneumatic controls requiring high flexibility, kink resistance and movement
	HU and HUM	High-pressure pneumatics requiring flexibility and kink resistance, robotics
Parprene™	TPE, Series G	Thermoplastic elastomer, black, general industrial tubing
	TPE, Series F	Thermoplastic elastomer, tan, food & dairy FDA compliant tubing
Vinyl	PV	Low-pressure chemical and medical applications requiring high clarity and flexibility, FDA

Tubing Pressure Ranges

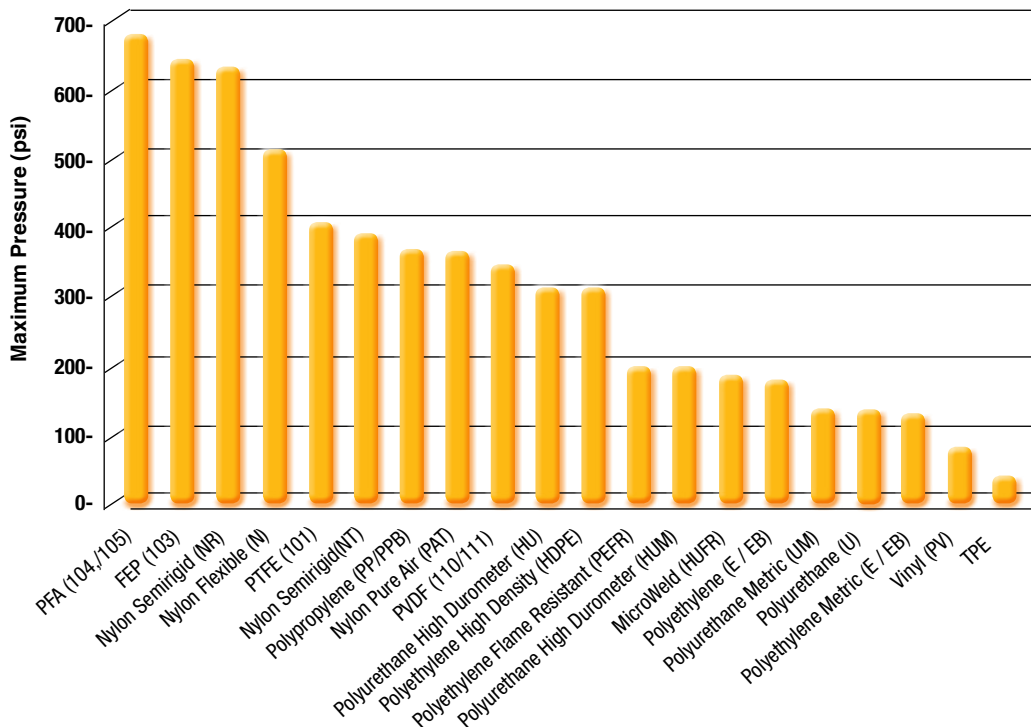

Working pressures are at 73°F (23°C). Pressure ratings are also effected by diameter of tubing and wall thickness. Actual performance may vary with different media and working conditions. Use this information for comparison only.

For detailed ordering information, please consult price list or contact Parflex® Division.

Parker Hannifin Corporation | Parflex® Division | Ravenna, Ohio | parker.com/pfd

www.comoso.com



Polyethylene Tubing

Series E: Instrument Grade – FDA, NSF Listed
Series EB: Ultraviolet Light Resistant



Features

- Made from 100% virgin resin material
- Chemically resistant and flexible
- High molecular weight resin provides increased dimensional stability, uniformity and long-term strength
- Economical system solution

Certifications

- FDA compliant for food contact
- ASTM D-1693 (10% IGEPAL) for stress crack resistance
- NSF - 51
- NSF - 61

Applications/Markets



- Potable water
- Chemical transfer
- Low-pressure pneumatics



Part Number	Part Number	Tube O.D.		Tube I.D.		Average Wall Thickness		Working Pressure at 73°F / 23°C		Minimum Burst at 73°F / 23°C		Package Quantity	Minimum Bend Radius		Weight	
		inch	mm	inch	mm	inch	mm	psi	bar	psi	bar		feet	inch	mm	lbs./ft.
#	#						Package quantities vary by size and color									
Natural	Black	inch	mm	inch	mm	inch	mm	psi	bar	psi	bar	feet	inch	mm	lbs./ft.	kg./mtr.
E-43-XXXX	EB-43-XXXX	1/4	6.4	.170	4.3	.040	1.0	120	8.3	480	33.1	0100, 0500, 1000	1.00	25.4	.011	.016
E-53-XXXX	EB-53-XXXX	5/16	7.9	.187	4.8	.062	1.6	145	10.0	580	40.0	0100, 0500	1.13	28.7	.020	.030
E-64-XXXX	EB-64-XXXX	3/8	9.5	.250	6.4	.062	1.6	125	8.6	500	34.5	0100, 0500	1.25	31.8	.025	.037
E-86-XXXX	EB-86-XXXX	1/2	12.7	.375	9.5	.062	1.6	90	6.2	360	24.8	0100, 0500	2.50	63.5	.034	.051
E-108-XXXX	EB-108-XXXX	5/8	15.9	.500	12.7	.062	1.6	70	4.8	280	19.3	0100	4.00	101.6	.044	.065

Standard black is not NSF approved.



For detailed ordering information, please consult price list or contact Parflex® Division.

Parker Hannifin Corporation | Parflex® Division | Ravenna, Ohio | parker.com/pfd

www.comoso.com

Order Information

Example: E-64-Y-0500

E-64-Y-0500 – Polyethylene

E-64-Y-0500 – **Tube O.D.** in sixteenths of an inch (**3/8"**)

E-64-Y-0500 – **Tube I.D.** in sixteenths of an inch (**.250"**)

E-64-Y-0500 – **Color**, i.e. **Yellow** (Omit for Natural and Black)

E-64-0500 – Natural Polyethylene

EB-64-0500 – Black Polyethylene

E-64-Y-0500 – **Package Quantity** in feet (**500'**)

Available in black as well as nine other colors, as recommended by the Instrument Society of America

Color Code		
●	-	Natural
●	-	Black
●	B	Blue
●	G	Green
●	O	Orange
●	P	Purple
●	R	Red
●	GRA	Gray
●	Y	Yellow
○	WHT	White

Polyethylene Tubing (Series E)

Maximum Working Pressure (psig)

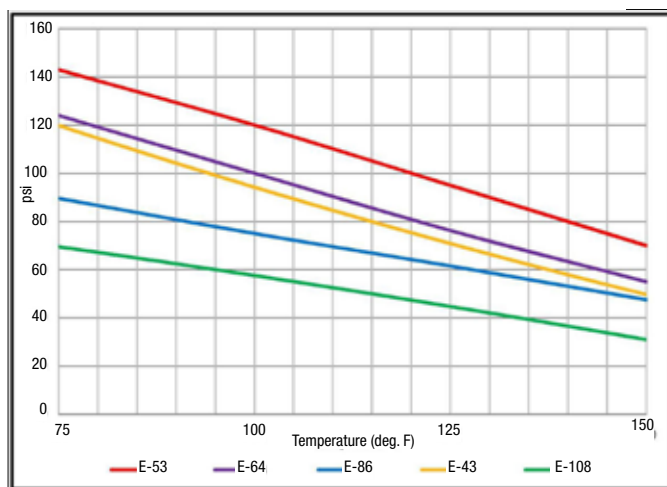

Fittings

Parker fittings available from:
Fluid System Connectors Division
Otsego, MI
(269) 692-6555
(269) 694-4614 FAX

FSC Product Families:

- Compression
- Compress-Align®
- Poly-Tite
- Hi-Duty
- Fast & Tite
- Flow Control
- Prestolok Brass
- Prestolok Composite
- Liquifit
- TrueSeal™
- Dubl-Barb®
- Prestomatic
- SAE Cartridge

A tube support should be used with this tubing for maximum holding power where end loading, vibration or pressure spikes may occur. Reference Tubing/Fitting Compatibility Chart (pg. B-6)

Notes

- FDA, NSF-51 and NSF-61 compliant black polyethylene tubing is also available. Add -NSF suffix to the EB part number (ie. EB-64-0500-NSF)
- E series natural and colored tubing meet FDA, NSF-51 requirements for food contact applications and NSF-61 for potable water
- Resistant to environmental stress cracking exceeding that of ordinary polyethylene tubing as measured by ASTM D-1693 (10% IGEPAL)
- Black (EB) tubing contains an ultraviolet inhibitor which is recommended for use in sunlit areas and in close proximity to high ultraviolet light sources
- All tubing conforms to ASTM D-1248, Type I, Class A, Category 4, Grade E5
- The recommended operating temperature range for service at rated pressures with compatible fluids is -80°F to +150°F (-62°C to +66°C)

Colors

- See Color Code Table

For detailed ordering information, please consult price list or contact Parflex® Division.

Metric Polyethylene Tubing

Series E: Instrument Grade – FDA, NSF Listed
Series EB: Ultraviolet Light Resistant



Features

- Made from 100% virgin resin material
- Chemically resistant and flexible
- High molecular weight resin provides increased dimensional stability, uniformity and long-term strength
- Economical system solution

Certifications

- FDA compliant for food contact
- ASTM D-1693 (10% IGEPAL) for stress crack resistance
- NSF - 51
- NSF - 61

Applications/Markets



- Potable water
- Chemical transfer
- Low-pressure pneumatics



Part Number	Part Number	Tube O.D.		Tube I.D.		Average Wall Thickness		Working Pressure at 73°F / 23°C		Minimum Burst at 73°F / 23°C		Package Quantity	Minimum Bend Radius		Weight		
		mm	inch	mm	inch	mm	inch	bar	psi	bar	psi		feet	mm	inch	kg./mtr.	lbs./ft.
#	#																
Natural	Black	mm	inch	mm	inch	mm	inch	bar	psi	bar	psi	feet	mm	inch	kg./mtr.	lbs./ft.	
E-6X1-0100	EB-6X1-0100	6	.236	4	.157	1.00	.039	8.6	125	34.5	500	0100	25	1.00	.019	.013	
E-8X1-0100	EB-8X1-0100	8	.315	6	.236	1.00	.039	6.9	100	27.6	400	0100	38	1.50	.021	.014	
E-10X1.5-0100	EB-10X1.5-0100	10	.393	7	.276	1.50	.059	8.6	125	34.5	500	0100	38	1.50	.039	.026	
E-12X1.5-0100	EB-12X1.5-0100	12	.472	9	.354	1.50	.059	6.2	100	24.8	400	0100	63	2.50	.048	.032	

Standard black is not NSF approved.



For detailed ordering information, please consult price list or contact Parflex® Division.

Parker Hannifin Corporation | Parflex® Division | Ravenna, Ohio | parker.com/pfd

www.comoso.com

Order Information

Example: E-8x1-0100

E-8x1-0100 – Metric Polyethylene (Natural)

EB-8x1-0100 – Metric Polyethylene (Black)

E-8x1-0100 – Tube O.D. in millimeters (8 mm)

E-8x1-0100 – Tube Wall Thickness in millimeters (1 mm)

E-8x1-0100 – Package Quantity in feet (100')

Metric Polyethylene Tubing (Series E)

Maximum Working Pressure (bar)

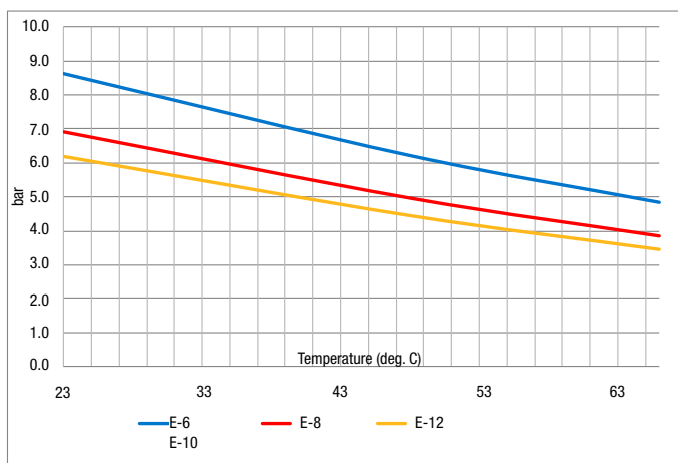

Fitting Recommendations

Parker fittings available from:
Fluid System Connectors Division
Otsego, MI
(269) 692-6555
(269) 694-4614 FAX

FSC Product Families:

- Metru-Lok™
- Flow Control
- Prestolok Brass
- Prestolok Composite
- Prestomatic

A tube support should be used with this tubing for maximum holding power where end loading, vibration or pressure spikes may occur. Reference Tubing/Fitting Compatibility Chart (pg. B-6)

Notes

- E series natural and colored tubing listed below meet FDA, NSF-51 requirements for food contact applications and NSF-61 for potable water
- Resistant to environmental stress cracking exceeding that of ordinary polyethylene tubing as measured by ASTM D-1693 (10% IGEPAL)
- Black (EB) tubing contains an ultraviolet inhibitor which is recommended for use in sunlit areas and in close proximity to high ultraviolet light sources
- All tubing conforms to ASTM D-1248, Type I, Class A, Category 4, Grade E5
- The recommended operating temperature range for service at rated pressures with compatible fluids is -80°F to +150°F (-62°C to +66°C)

Colors

- Natural
- Black

For detailed ordering information, please consult price list or contact Parflex® Division.

Parker Hannifin Corporation | Parflex® Division | Ravenna, Ohio | parker.com/pfd

www.comoso.com



Polyethylene Tubing

Series PEFR: Flame Resistant

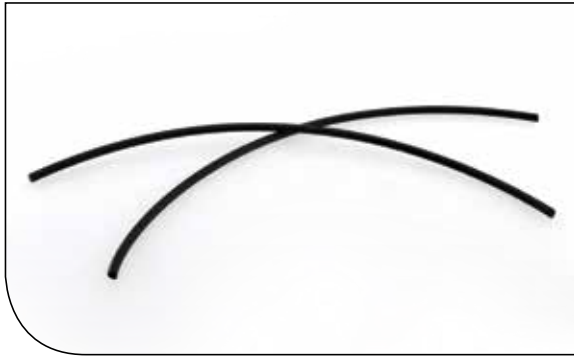

Features

- Excellent stress crack resistance

Certifications

- UL 94 V-2
- ASTM D-1693 (10% IGEPAL) for stress crack resistance

Applications/Markets



- Pneumatic controls in HVAC applications

Part Number	Tube O.D.		Tube I.D.		Average Wall Thickness		Working Pressure at 73°F / 23°C		Minimum Burst at 73°F / 23°C		Package Quantity	Minimum Bend Radius		Weight	
	inch	mm	inch	mm	inch	mm	psi	bar	psi	bar		feet	inch	mm	lbs./ft.
#															
Black	inch	mm	inch	mm	inch	mm	psi	bar	psi	bar	feet	inch	mm	lbs./ft.	kg./mtr.
PEFR-2.5-XXXX	5/32	4.0	.096	2.4	.030	0.76	185	12.8	740	51.0	0500	.50	12.7	.006	.009
PEFR-4-XXXX	1/4	6.4	.170	4.3	.040	1.0	140	9.7	560	38.6	0500, 1000	.75	17.4	.012	.018
PEFR-6-XXXX	3/8	9.5	.250	6.4	.062	1.6	155	10.7	620	42.8	0500	1.50	36.1	.029	.043
PEFR-8-XXXX	1/2	12.7	.375	9.5	.062	1.6	100	6.9	400	27.6	0250	1.75	39.1	.041	.061

Order Information

Example: PEFR-4-0500

PEFR-4-0500 – Flame Resistant Polyethylene

PEFR-4-0500 – **Tube O.D.** in sixteenths of an inch (**1/4"**)

PEFR-4-**0500** – **Package Quantity** in feet (**500'**)

Flame Resistant Polyethylene Tubing (Series PEFR) Maximum Working Pressure (psig)

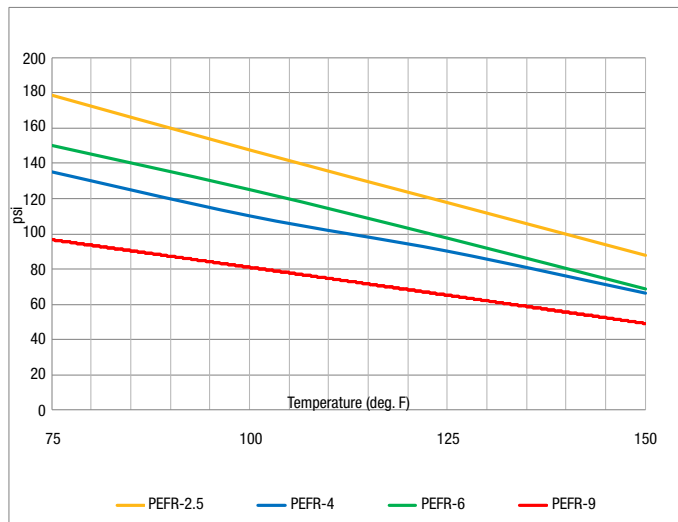

Fittings

Parker fittings available from:
Fluid System Connectors Division
Otsego, MI
(269) 692-6555
(269) 694-4614 FAX

- FSC Product Families:
- Compression
- Compress-Align®
- Hi-Duty
- Fast & Tite
- Flow Control
- Prestolok Brass
- Dubl-Barb®

A tube support should be used with this tubing for maximum holding power where end loading, vibration or pressure spikes may occur. Reference Tubing/Fitting Compatibility Chart (pg. B-6)

Notes

Using the same base linear low-density polyethylene (LLDPE) as the E-Series tubing, Parker Hannifin, Parflex Division's PEFR tubing has the following advantages:

- Resistant to environmental stress cracking exceeding that of ordinary polyethylene tubing as measured by ASTM D-1693 (10% IGEPAL)
- The recommended operating temperature range for service at rated pressures with compatible fluids is -85°F to +150°F (-65°C to +66°C)

Colors

- Black

For detailed ordering information, please consult price list or contact Parflex® Division.

Parker Hannifin Corporation | Parflex® Division | Ravenna, Ohio | parker.com/pfd

www.comoso.com



B-15

A
Hose

B
Tubing
Thermoplastic

C
Coiled Air Hose
& Fittings

D
Transportation

E
Fittings

F
Tooling, Equipment
& Accessories

G
General Technical

Polyethylene Tubing

Series HDPE: High Density



Features

- Manufactured from high strength, high density polyethylene
- Semi-rigid tubing that is inherently resistant to most chemicals, less easily cut or damaged and has a higher burst pressure rating than Series E tubing
- Economical system solution

Applications/Markets



- Potable water
- Chemical transfer
- Low-pressure pneumatics



Part Number	Tube O.D.		Tube I.D.		Average Wall Thickness		Working Pressure at 73°F / 23°C		Minimum Burst at 73°F / 23°C		Package Quantity	Minimum Bend Radius		Weight		
	inch	mm	inch	mm	inch	mm	psi	bar	psi	bar		feet	inch	mm	lbs./ft.	kg./mtr.
#																
Black	inch	mm	inch	mm	inch	mm	psi	bar	psi	bar	feet	inch	mm	lbs./ft.	kg./mtr.	
HDPE-43-XXXX	1/4	6.4	.170	4.3	.040	1.0	300	20.7	1200	82.7	0250, 0500	1.50	38.1	.011	.016	
HDPE-64-XXXX	3/8	8.5	.250	6.4	.062	1.6	300	20.7	1200	82.7	0250, 0500	2.50	63.5	.025	.037	

Only available in black.



For detailed ordering information, please consult price list or contact Parflex® Division.

Parker Hannifin Corporation | Parflex® Division | Ravenna, Ohio | parker.com/pfd

www.comoso.com

Order Information

Example: HDPE-43-0500

HDPE-43-0500 – High Density Polyethylene

HDPE-**43**-0500 – **Tube O.D.** in sixteenths of an inch (**1/4"**)

HDPE-**43**-0500 – **Tube I.D.** in sixteenths of an inch (**.170"**)

HDPE-43-**0500** – **Package Quantity** in feet (**500'**)

High Density Polyethylene Tubing (Series HDPE)

Maximum Working Pressure (psig)

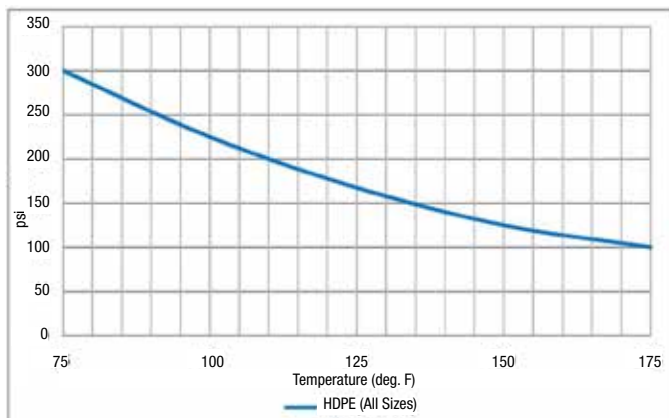

Fittings

Parker fittings available from:
Fluid System Connectors Division
Otsego, MI
(269) 692-6555
(269) 694-4614 FAX

- FSC Product Families:
- Compression
- Compress-Align®
- Dubl-Barb
- Hi-Duty
- Fast & Tite
- Prestolok Brass

A tube support should be used with this tubing for maximum holding power where end loading, vibration or pressure spikes may occur. Reference Tubing/Fitting Compatibility Chart (pg. B-6)

Notes

- Recommended operating temperature range for service at rated pressures with compatible fluids is -80°F to +175°F (-62°C to +80°C)

Colors

- Black

For detailed ordering information, please consult price list or contact Parflex® Division.

Parker Hannifin Corporation | Parflex® Division | Ravenna, Ohio | parker.com/pfd

www.comoso.com



B-17

Nylon Tubing

Series N: Flexible

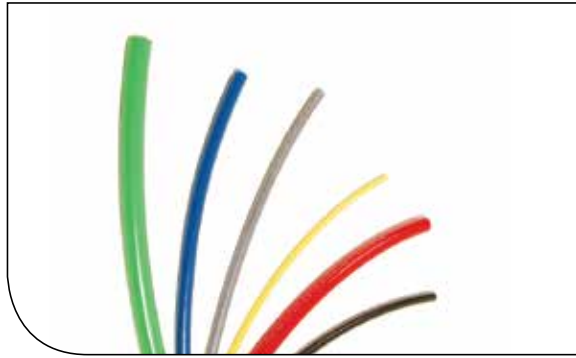

Features

- Flexible nylon tubing uses high-grade resins for strength and flexibility for routing in tight spaces
- Made from abrasion-resistant, heat and light-stabilized nylon
- Exhibits low-level water absorption
- Chemically resistant

Applications/Markets



- Robotics
- Machine tool
- General pneumatics
- Lubrication

- Petroleum-based chemical transfer
- Pest control lines



Part Number	Part Number	Tube O.D.		Tube I.D.		Average Wall Thickness		Working Pressure at 73°F / 23°C		Minimum Burst at 73°F / 23°C		Reel Length	Minimum Bend Radius		Weight	
		inch	mm	inch	mm	inch	mm	psi	bar	psi	bar		feet	inch	mm	lbs./ft.
#	#															
Natural	Black															
NN-2-016	NB-2-016	1/8	3.2	.093	2.4	.016	0.41	250	17.2	1000	69.0	0100, 0250	.25	4.6	.003	.005
NN-2-031	NB-2-031	1/8	3.2	.064	1.6	.031	0.79	500	34.5	2000	137.9	0100, 0250	.25	4.6	.004	.006
NN-2.5-025	NB-2.5-025	5/32	4.0	.106	2.7	.025	0.64	300	20.7	1200	82.7	0100, 0250	.50	12.7	.005	.007
NN-3-025	NB-3-025	3/16	4.8	.138	3.5	.025	0.64	250	17.2	1000	69.0	0100, 0250	.63	16.0	.006	.009
NN-3-046	NB-3-046	3/16	4.8	.096	2.4	.046	1.2	500	34.5	2000	137.9	0100, 0250	.44	11.2	.009	.013
NN-4-035	NB-4-035	1/4	6.4	.180	4.6	.035	0.89	250	17.2	1000	69.0	0100, 0250	.88	22.4	.011	.016
NN-4-040	NB-4-040	1/4	6.4	.170	4.3	.040	1.0	310	21.4	1250	86.2	0100, 0250	.88	22.4	.012	.018
NN-4-062	NB-4-062	1/4	6.4	.127	3.2	.062	1.6	500	34.5	2000	137.9	0100, 0250	.50	12.7	.017	.025
NN-5-040	NB-5-040	5/16	7.9	.233	5.9	.040	1.0	250	17.2	1000	69.0	0100, 0250	1.13	28.7	.016	.024
NN-6-050	NB-6-050	3/8	9.5	.275	7.0	.050	1.3	250	17.2	1000	69.0	0100, 0250	1.13	28.7	.023	.034
NN-6-093	NB-6-093	3/8	9.5	.190	4.8	.093	2.4	500	34.5	2000	137.9	0100, 0250	.75	19.0	.038	.056
NN-8-062	NB-8-062	1/2	12.7	.375	9.5	.062	1.6	250	17.2	1000	69.0	0100, 0250	1.25	31.8	.039	.058
NN-8-124	NB-8-124	1/2	12.7	.253	6.4	.124	3.2	500	34.5	2000	137.9	0100, 0250	1.00	25.4	.067	.099



For detailed ordering information, please consult price list or contact Parflex® Division.

Order Information

Example: N-2-016-RED-0100

N-2-016-RED-0100 – Nylon

N-2-016-RED-0100 – **Tube O.D.** in sixteenths of an inch (**1/8"**)

N-2-**016**-RED-0100 – **Wall Thickness** in inches (**.016"**)

N-2-016-**RED**-0100 – **Colors** (Omit for Natural and Black)

NN-2-016-0100 - Natural Nylon

NB-2-016-0100 - Black Nylon

N-2-016-RED-**0100** – **Package Quantity** in feet (**100'**)

(Omit quantity number after color for 250' reel length)

Color Code		
○	NN	Natural
●	NB	Black
●	BLU	Blue
●	GRN	Green
●	RED	Red
●	YEL	Yellow

Nylon Tubing (Series N)

Maximum Working Pressure (psig)

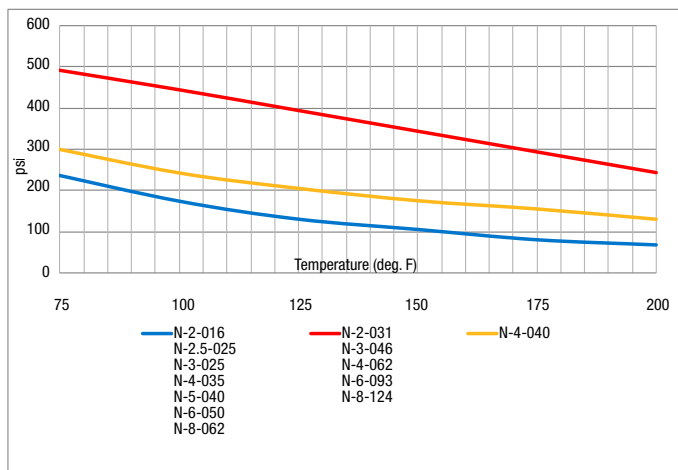

Fittings

Parker fittings available from:
Fluid System Connectors Division
Otsego, MI
(269) 692-6555
(269) 694-4614 FAX

FSC Product Families:

- Compression
- Compress-Align®
- Poly-Tite
- Hi-Duty
- Fast & Tite
- Flow Control
- Prestolok Brass
- Prestolok Composite
- TrueSeal™
- NTA®
- Transmission
- Prestomatic
- SAE Cartridge

A tube support should be used with this tubing for maximum holding power where end loading, vibration or pressure spikes may occur. Reference Tubing/Fitting Compatibility Chart (pg. B-6)

Notes

- The recommended operating temperature range for service at rated pressures with compatible fluids, depending upon conditions, is -65°F to +200°F (-54°C to +93°C)
- Black tubing suggested for use in sunlit areas and in close proximity to high ultraviolet light sources

Colors

- See Color Code Table

For detailed ordering information, please consult price list or contact Parflex® Division.



Metric Nylon Tubing

Series N: Flexible



Features

- Flexible nylon tubing uses high-grade resins for strength and flexibility for routing in tight spaces
- Made from abrasion-resistant, heat and light-stabilized nylon
- Exhibits low-level water absorption
- Chemically resistant

Applications/Markets



- Robotics
- Machine tool
- General pneumatics
- Lubrication

- Petroleum-based chemical transfer
- Pest control lines



Part Number	Part Number	Tube O.D.		Tube I.D.		Average Wall Thickness		Working Pressure at 73°F / 23°C		Minimum Burst at 73°F / 23°C		Reel Length	Weight	
		mm	inch	mm	inch	mm	inch	bar	psi	bar	psi		kg./mtr.	lbs./ft.
#	#													
Natural	Black	mm	inch	mm	inch	mm	inch	bar	psi	bar	psi	feet	kg./mtr.	lbs./ft.
NN4X.65	NB4X.65	4	.157	2.7	.107	0.65	.026	20.7	300	82.7	1200	100	.007	.005
NN6X1	NB6X1	6	.236	4.0	.157	1.00	.039	23.5	341	94	1363	100	.016	.011
NN8X1	NB8X1	8	.315	6.0	.236	1.00	.039	17.0	247	68	986	100	.024	.016
NN10X1	NB10X1	10	.393	8.0	.315	1.00	.039	12.5	181	50	725	100	.030	.020
NN12X1	NB12X1	12	.472	10.0	.393	1.00	.039	11.0	160	44	638	100	.036	.024
NN14X1.5	NB14X1.5	14	.551	11.0	.433	1.50	.059	15.0	218	60	870	100	.063	.042
NN16X1.5	NB16X1.5	16	.630	13.0	.512	1.50	.059	12.5	181	50	725	100	.073	.049
NN18X1.5	NB18X1.5	18	.709	15.0	.591	1.50	.059	10.5	152	42	609	100	.082	.055
NN20X1.5	NB20X1.5	20	.787	17.0	.669	1.50	.059	9.5	138	38	551	100	.092	.062

Order Information

Example: NN4x.65

NN4x.65 – Natural Nylon

NN4x.65 – Tube O.D. in millimeters (4mm)

NN4x.65 – Wall Thickness in millimeters (0.65mm)

Metric Nylon Tubing (Series N)

Maximum Working Pressure (bar)

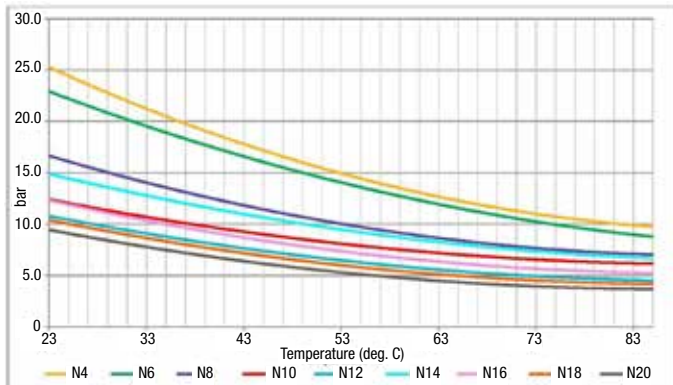

Fittings

Parker fittings available from:
Fluid System Connectors Division
Otsego, MI
(269) 692-6555
(269) 694-4614 FAX

FSC Product Families:

- Metru-Lok™
- Flow Control
- Prestolok Brass
- Prestolok Composite
- Prestomatic

A tube support should be used with this tubing for maximum holding power where end loading, vibration or pressure spikes may occur. Reference Tubing/Fitting Compatibility Chart (pg. B-6)

Notes

- The recommended operating temperature range for service at rated pressures with compatible fluids, depending upon conditions, is -54°C to +93°C (-65°F to +200°F)
- Black tubing suggested for use in sunlit areas and in close proximity to high ultraviolet light sources

Colors

- Natural
- Black

For detailed ordering information, please consult price list or contact Parflex® Division.

Parker Hannifin Corporation | Parflex® Division | Ravenna, Ohio | parker.com/pfd

www.comoso.com



B-21

A
Hose

B
Tubing
Thermoplastic

C
Coiled Air Hose
& Fittings

D
Transportation

E
Fittings

F
Tooling, Equipment
& Accessories

G
General Technical

Nylon Pure Air Tubing

Series PAT: Ultra Pure, UV Resistant

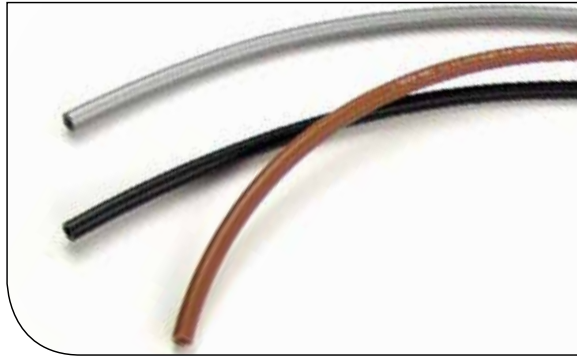

Features

- The tubing choice for pure air systems (semiconductor) due to its cleanliness and excellent chemical and UV light resistance
- Maintains good resistance to high ambient temperatures with low moisture absorption
- Manufactured from a specially formulated nylon for use in pure air and gas distribution systems
- Provides high tensile strength with excellent coupling retention in high pressure, temperature and vibration environments
- Sizes -2 and -4 are single wall tubing construction
- Sizes -6 through -12 are reinforced tubing construction

Applications/Markets



- Pure air and gas distribution systems
- Semi-conductor



Part Number	Tube O.D.		Tube I.D.		Average Wall Thickness		Working Pressure at 73°F /23°C		Minimum Burst at 73°F /23°C		Reel Length	Minimum Bend Radius		Weight	
	#	inch	mm	inch	mm	inch	mm	psi	bar	psi		bar	feet	inch	mm
PAT2	1/8	3.2	.079	2.0	.023	0.58	250	17.2	1000	69.0	1000	.37	9.4	.035	.052
PAT4	1/4	6.4	.170	4.3	.040	1.0	300	20.7	1200	82.7	1000	1.00	25.4	.124	.185
PAT6	3/8	9.5	.251	6.4	.062	1.6	350	24.1	1400	96.4	500	1.50	38.1	.282	.420
PAT8	1/2	12.7	.376	9.6	.062	1.6	235	16.2	950	65.5	500	2.00	50.8	.395	.588
PAT10	5/8	15.9	.441	11.2	.092	2.3	225	15.5	900	62.1	250	2.50	63.5	.702	1.04
PAT12	3/4	19.1	.566	14.4	.092	2.3	200	13.8	800	55.2	250	3.00	76.2	.872	1.30



For detailed ordering information, please consult price list or contact Parflex® Division.

Parker Hannifin Corporation | Parflex® Division | Ravenna, Ohio | parker.com/pfd

www.comoso.com

Order Information

Example: PAT4-BLK-0250

PAT4-BLK-0250 – Pure Air Tubing

PAT4-BLK-0250 – Tube O.D. in sixteenths of an inch (**1/4"**)

PAT4-BLK-0250 – Color (**Black**)

PAT4-BLK-0250 – Package Quantity in feet (**250'**)

Color Code		
●	BLK	Black
●	BRN	Brown
●	SIL	Silver

Pure Air Nylon Tubing (Series PAT)

Maximum Working Pressure (psig)

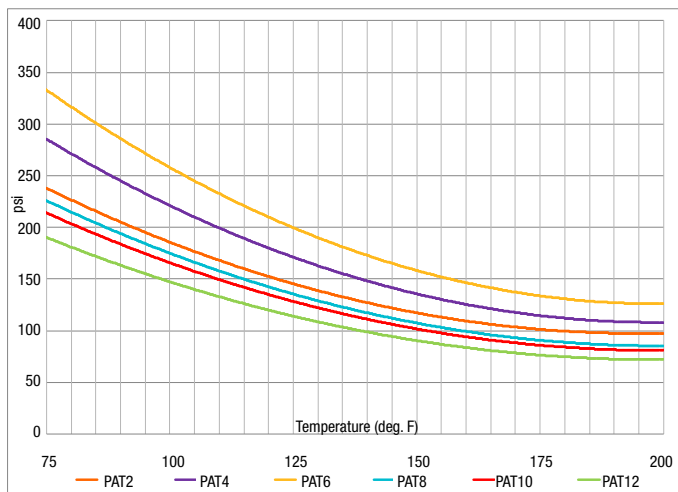

Fittings

Parker fittings available from:
Fluid System Connectors Division
Otsego, MI
(269) 692-6555
(269) 694-4614 FAX

FSC Product Families:

- Compression
- Compress-Align*
- Hi-Duty
- Fast & Tite
- NTA*

A tube support should be used with this tubing for maximum holding power where end loading, vibration or pressure spikes may occur. Reference Tubing/Fitting Compatibility Chart (pg. B-6)

Notes

- Packaged on corrugated plastic reel with ends capped and shipped in a plastic-lined container
- The suggested operating temperature range for service at rated pressures with compatible fluids is -70°F to +200°F (-57°C to +93°C)
- PAT tubing is rated for full vacuum service at 28 inch Hg

Colors

- See Color Code Table

For detailed ordering information, please consult price list or contact Parflex® Division.

Nylon Tubing

Series NR: Semi-rigid High Strength



Features

- High grade nylon resins without the addition of plasticizers for higher pressure tubing applications
- Better chemical resistance than Series N, good resistance to high ambient temperature and low moisture absorption
- High tensile strength and excellent coupling retention in high pressure, temperature and vibration environments

Applications/Markets



- High-pressure pneumatics and oils
- Lubrication systems
- Marine control systems
- Process lines for chemicals



Part Number	Part Number	Tube O.D.		Tube I.D.		Average Wall Thickness		Working Pressure at 73°F /23°C		Minimum Burst at 73°F /23°C		Reel Length	Minimum Bend Radius		Weight	
		inch	mm	inch	mm	inch	mm	psi	bar	psi	bar		feet	inch	mm	lbs./ft.
NNR-2-017	NBR-2-017	1/8	3.2	.091	2.3	.017	0.43	425	29.3	1700	117.2	0100, 0500	.50	12.7	.003	.005
NNR-2-026	NBR-2-026	1/8	3.2	.073	1.9	.026	0.66	625	43.1	2500	172.4	0100, 0500	.38	9.7	.004	.006
NNR-3-024	NBR-3-024	3/16	4.8	.140	3.6	.024	0.61	425	29.3	1700	117.2	0100, 0500	.75	19.0	.006	.009
NNR-3-039	NBR-3-039	3/16	4.8	.110	2.8	.039	0.99	625	43.1	2500	172.4	0100, 0500	.63	16.0	.008	.012
NNR-4-035	NBR-4-035	1/4	6.4	.180	4.6	.035	0.89	425	29.3	1700	117.2	0100, 0250	1.00	25.4	.011	.016
NNR-4-050	NBR-4-050	1/4	6.4	.150	3.9	.050	1.3	625	43.1	2500	172.4	0100, 0250	.88	22.3	.014	.021
NNR-5-040	NBR-5-040	5/16	7.9	.233	5.9	.040	1.0	425	29.3	1700	117.2	0100, 0250	1.50	38.1	.015	.022
NNR-6-048	NBR-6-048	3/8	9.5	.279	7.1	.048	1.2	425	29.3	1700	117.2	0100, 0250	1.75	44.5	.022	.033
NNR-6-075	NBR-6-075	3/8	9.5	.225	5.7	.075	1.9	625	43.1	2500	172.4	0100, 0250	1.50	38.1	.032	.048
NNR-8-062	NBR-8-062	1/2	12.7	.375	9.5	.062	1.6	375	26	1500	103.4	0100, 0250	2.38	60.5	.038	.057
NNR-8-075	NBR-8-075	1/2	12.7	.350	8.9	.075	1.9	625	43.1	2500	172.4	0100, 0250	2.50	63.5	.045	.067

Order Information

Example: NBR-2-017-0100

NBR-2-017-0100 – Nylon

NBR-2-017-0100 – Color (Black)

NBR-2-017-0100 – Rigid

NBR-2-017-0100 – Tube O.D. in sixteenths of an inch (**1/8"**)

NBR-2-017-0100 – Wall Thickness in inches (**.017"**)

NBR-2-017-0100 – Package Quantity in feet (**100'**)

(Omit for other package quantities)

Semi-rigid Nylon Tubing (Series NR)

Maximum Working Pressure (psig)

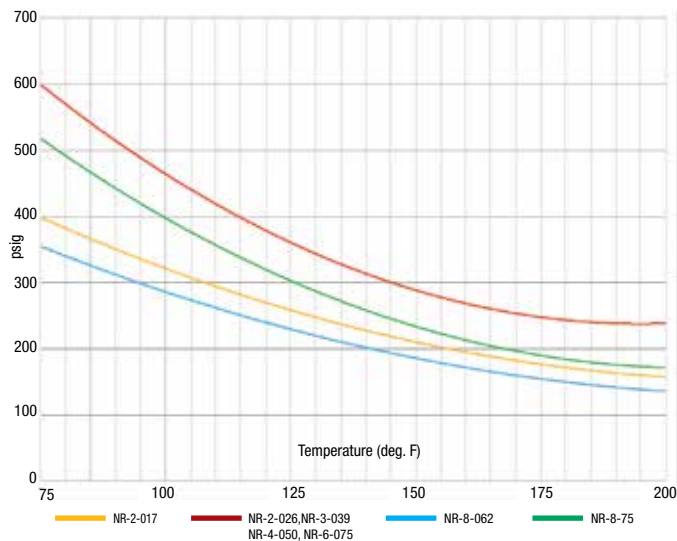

Fittings

Parker fittings available from:
 Fluid System Connectors Division
 Otsego, MI
 (269) 692-6555
 (269) 694-4614 FAX

FSC Product Families:

- Compression
- Compress-Align®
- Hi-Duty
- Fast & Tite
- Flow Control
- Prestolok Brass
- Prestolok Composite
- TrueSeal™

A tube support should be used with this tubing for maximum holding power where end loading, vibration or pressure spikes may occur. Reference Tubing/Fitting Compatibility Chart (pg. B-6)

Notes

- Suggested operating temperature range for service at rated pressures with compatible fluids is -60°F to +200°F (-51°C to +93°C)

Colors

- Natural
- Black

For detailed ordering information, please consult price list or contact Parflex® Division.

Parker Hannifin Corporation | Parflex® Division | Ravenna, Ohio | parker.com/pfd

www.comoso.com



B-25

A
Hose

B
Tubing
Thermoplastic

C
Coiled Air Hose
& Fittings

D
Transportation

E
Fittings

F
Tooling, Equipment
& Accessories

G
General Technical

Nylon Tubing

Series NTNA: Semi-rigid Nylon Tubing



Features

- High grade nylon resins without the addition of plasticizers
- High tensile strength and excellent coupling retention in high pressure, temperature and vibration environments
- Excellent chemical resistance
- Rugged construction resists vermin attack

Certifications

- NSF-51

Applications/Markets



- Instrumentation lines
- Lubrication systems
- Process piping systems
- Refrigerant lines

Part Number	Tube O.D.		Tube I.D.		Average Wall Thickness		Working Pressure at 73°F / 23°C		Minimum Burst at 73°F / 23°C		Reel Length	Minimum Bend Radius		Weight	
	#	inch	mm	inch	mm	inch	mm	psi	bar	psi		bar	feet	inch	mm
22NTNA	1/8	3.2	.091	2.3	.017	0.4	375	25.9	1,500	103.4	500	0.50	12.7	.003	.005
532NTNA	5/32	4.0	.113	2.9	.022	0.6	375	25.9	1,500	103.4	500	0.63	16.0	.004	.006
33NTNA	3/16	4.8	.139	3.5	.024	0.6	375	25.9	1,500	103.4	350	0.75	19.0	.006	.009
44NTNA	1/4	6.4	.184	4.7	.033	0.8	375	25.9	1,500	103.4	200	1.00	25.4	.010	.015
55NTNA	5/16	7.9	.232	5.8	.040	1.0	375	25.9	1,500	103.4	150	1.50	38.1	.015	.022
66NTNA	3/8	9.5	.282	7.1	.048	1.2	375	25.9	1,500	103.4	100	1.75	44.4	.022	.033
88NTNA	1/2	12.7	.375	9.5	.062	1.6	375	25.9	1,500	103.4	100	2.38	60.5	.032	.048

Order Information

Example: 44NTNA

44NTNA – Tube O.D. in sixteenths of an inch (1/4")

44NTNA – Nylon Tubing

44NTNA – Color (Natural)

Semi-rigid Nylon Tubing (Series NTNA)

Maximum Working Pressure (psig)

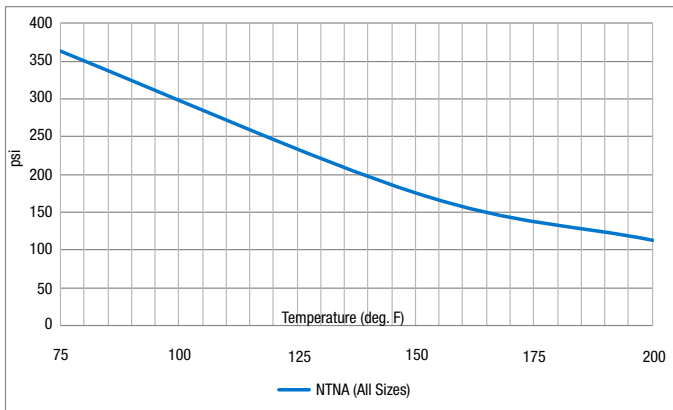

Fittings

Parker fittings available from:
Fluid System Connectors Division
Otsego, MI
(269) 692-6555
(269) 694-4614 FAX

FSC Product Families:

- Compression
- Compress-Align®
- Poly-Tite
- Hi-Duty
- Fast & Tite
- Flow Control
- NTA
- Prestolok Brass
- Prestolok Composite
- Prestomatic
- SAE Cartridges
- Transmission
- TrueSeal™

A tube support should be used with this tubing for maximum holding power where end loading, vibration or pressure spikes may occur. Reference Tubing/Fitting Compatibility Chart (pg. B-6)

Notes

- Suggested operating temperature range from -60°F to +212°F (-51°C to +100°C)

Colors

- Natural

For detailed ordering information, please consult price list or contact Parflex® Division.

Parker Hannifin Corporation | Parflex® Division | Ravenna, Ohio | parker.com/pfd

www.comoso.com



B-27

TPE Parprene™ Tubing

Series G: General Industrial



Features

- Excellent flexural fatigue resistance
- Ozone and UV light resistant
- Temperatures from (-75°F to 275°F)
- Abrasion resistant
- Resistant to environmental stress cracking
- Lot-to-lot traceability
- Chemically compatible with common sanitizers and cleaners
- Extensive range of compatible Parker fittings and couplers

Applications/Markets



- Wastewater Sampling
- Cable Insulation
- Caustic Dispensing
- Ink and toner feed lines
- Chemical Transfer



Part Number	Tube O.D. (Ref.)		Tube I.D.		Wall Thickness		Maximum Working Pressure		Minimum Bend Radius		Standard Coil		Weight per 100 feet	
	inch	mm	inch	mm	inch	mm	psi	bar	inch	mm	feet	mtr.	lb.	kg.
#														
G64-31	0.188	5	0.062	2	0.062	1.59	34	2.34	1/4	6	50	15.2	1.03	0.47
G64-42	0.250	6	0.125	3	0.062	1.59	19	1.31	1/2	13	50	15.2	1.55	0.70
G64-53	0.312	8	0.188	5	0.062	1.59	13	0.90	3/4	19	50	15.2	2.06	0.93
G64-64	0.375	10	0.250	6	0.062	1.59	10	0.69	1-1/4	32	50	15.2	2.58	1.17
G64-75	0.438	11	0.312	8	0.062	1.59	8	0.55	1-1/2	38	50	15.2	3.10	1.41
G64-84	0.500	13	0.250	6	0.125	3.18	19	1.31	3/4	19	50	15.2	6.19	2.81
G64-86	0.500	13	0.375	10	0.062	1.59	7	0.48	2-1/4	57	50	15.2	3.61	1.64
G64-106	0.625	16	0.375	10	0.125	3.18	13	0.90	1-1/4	32	50	15.2	8.26	3.75
G64-128	0.750	19	0.500	13	0.125	3.18	10	0.69	2	51	50	15.2	10.32	4.68
G64-1410	0.875	22	0.625	16	0.125	3.18	8	0.55	3-1/4	83	50	15.2	12.39	5.62
G64-1612	1.000	25	0.750	19	0.125	3.18	7	0.48	4	102	50	15.2	14.45	6.56

Order Information

Example: G64-31

G64-31 – TPE, General Series

G64-31 – Hardness Durometer (64 Shore A)

G64-**31** – Tube O.D. in sixteenths of an inch (**3/16"**)

G64-**31** – Tube I.D. in sixteenths of an inch (**1/16"**)

Fittings

Parker fittings available from:
Fluid System Connectors Division
Otsego, MI
(269) 692-6555
(269) 694-4614 FAX

FSC Product Families:

- Par-Barb® Thermoplastic
- Dubl-Barb®
- Hose Barb

Couplings

Parker couplings available from:
Quick Coupling Division
Minneapolis, MN
(763) 544-7781
(763) 544-3418 FAX

QCD Product Families:

- Spectrum Series
- PPM Series
- PPL Series

Notes

- TPE is a thermoplastic elastomer formulated to withstand the rigors of peristaltic pump applications and yet, be safe enough for food and beverage applications.
- Suggested operating temperature range for service at rated pressures with compatible fluids is -75°F to +275°F (-59°C to 135°C)
- Packaged 50 foot coils - sealed clear polyethylene bag, barcoded, 1 per box for lot traceability
- Special lengths available, contact Parflex division

Colors

- Black

For detailed ordering information, please consult price list or contact Parflex® Division.

Parker Hannifin Corporation | Parflex® Division | Ravenna, Ohio | parker.com/pfd

www.comoso.com



B-29

A
Hose

B
Tubing
Thermoplastic

C
Coiled Air Hose
& Fittings

D
Transportation

E
Fittings

F
Tooling, Equipment
& Accessories

G
General Technical

TPE Parprene™ Tubing

Series F: Food & Dairy



Features

- Excellent flexural fatigue resistance
- Ozone and UV light resistant
- Temperatures from (-75°F to 275°F)
- Abrasion resistant
- Resistant to environmental stress cracking
- Lot-to-lot traceability
- Chemically compatible with common sanitizers and cleaners
- Extensive range of compatible Parker fittings and couplers

Certifications

- FDA compliant for food contact
- NSF-51 Approved
- 3-A Approved

Applications/Markets



- Hot/Cold beverage dispensing
- Food and dairy processing lines
- Chemical transfer
- Water purification lines
- Soap dispensing



Part Number	Tube O.D. (Ref.)		Tube I.D.		Wall Thickness		Maximum Working Pressure		Minimum Bend Radius		Standard Coil		Weight per 100 feet		
	inch	mm	inch	mm	inch	mm	psi	bar	inch	mm	feet	mtr.	lb.	kg.	
#															
F64-31	0.188	5	0.062	2	0.062	1.59	34	2.34	1/4	6	50	15.2	1.03	0.47	
F64-42	0.250	6	0.125	3	0.062	1.59	19	1.31	1/2	13	50	15.2	1.55	0.70	
F64-53	0.312	8	0.188	5	0.062	1.59	13	0.90	3/4	19	50	15.2	2.06	0.93	
F64-64	0.375	10	0.250	6	0.062	1.59	10	0.69	1-1/4	32	50	15.2	2.58	1.17	
F64-75	0.438	11	0.312	8	0.062	1.59	19	1.31	1-1/2	38	50	15.2	3.10	1.41	
F64-84	0.500	13	0.250	6	0.125	3.18	8	0.55	3/4	19	50	15.2	6.19	2.81	
F64-86	0.500	13	0.375	10	0.062	1.59	7	0.48	2-1/4	57	50	15.2	3.61	1.64	
F64-106	0.625	16	0.375	10	0.125	3.18	13	0.90	1-1/4	32	50	15.2	8.26	3.75	
F64-128	0.750	19	0.500	13	0.125	3.18	10	0.69	2	51	50	15.2	10.32	4.68	
F64-1410	0.875	22	0.625	16	0.125	3.18	8	0.55	3-1/4	83	50	15.2	12.39	5.62	
F64-1612	1.000	25	0.750	19	0.125	3.18	7	0.48	4	102	50	15.2	14.45	6.56	

Order Information

Example: F64-31

F64-31 – TPE, General Series

F64-31 – Hardness Durometer (64 Shore A)

F64-31 – Tube O.D. in sixteenths of an inch (3/16")

F64-31 – Tube I.D. in sixteenths of an inch (1/16")

Fittings

Parker fittings available from:
Fluid System Connectors Division
Otsego, MI
(269) 692-6555
(269) 694-4614 FAX

FSC Product Families:

- Par-Barb® Thermoplastic
- Dubl-Barb®
- Hose Barb

Couplings

Parker couplings available from:
Quick Coupling Division
Minneapolis, MN
(763) 544-7781
(763) 544-3418 FAX

QCD Product Families:

- Spectrum Series
- PPM Series
- PPL Series

Notes

- TPE is a thermoplastic elastomer formulated to withstand the rigors of peristaltic pump applications and yet, be safe enough for food and beverage applications.
- Suggested operating temperature range for service at rated pressures with compatible fluids is -75°F to +275°F (-59°C to +135°C)
- Packaged 50 foot coils - sealed clear polyethylene bag, barcoded, 1 per box for lot traceability
- Special lengths available, contact Parflex division

Colors

- Tan

For detailed ordering information, please consult price list or contact Parflex® Division.

Parker Hannifin Corporation | Parflex® Division | Ravenna, Ohio | parker.com/pfd

www.comoso.com



B-31

A
Hose

B
Tubing
Thermoplastic

C
Coiled Air Hose
& Fittings

D
Transportation

E
Fittings

F
Tooling, Equipment
& Accessories

G
General Technical

Polypropylene Tubing

Series PP: Laboratory Grade – FDA, NSF Listed
Series PPB: Ultraviolet Light Resistant



Features

- Acid and chemically resistant
- May be used in higher temperatures and working pressures than polyethylene tubing
- Excellent compatibility with high temperature water
- Low water absorption (less than .01%)
- Good compatibility with vegetable oils
- Excellent resistance to environmental stress cracking

Certifications

- FDA Both in white; NSF also in special black part numbers
- NSF-51

Applications/Markets



- Food contact - White only
- Chemical transfer
- Chlorinated water



Part Number	Part Number	Tube O.D.		Tube I.D.		Average Wall Thickness		Working Pressure at 73°F / 23°C		Minimum Burst at 73°F / 23°C		Reel Length	Minimum Bend Radius		Weight	
		inch	mm	inch	mm	inch	mm	psi	bar	psi	bar		feet	inch	mm	lbs./ft.
#	#															
White	Black	inch	mm	inch	mm	inch	mm	psi	bar	psi	bar	feet	inch	mm	lbs./ft.	kg./mtr.
PP-21-1000	PPB-21-1000	1/8	3.2	.079	2.0	.023	0.58	350	24.1	1400	96.4	1000	.50	12.7	.003	.005
PP-32-0500	PPB-32-0500	3/16	4.8	.120	3.1	.034	0.86	350	24.1	1400	96.4	0500	.75	14.4	.006	.009
PP-43-0500	PPB-43-0500	1/4	6.4	.170	4.3	.040	1.0	300	20.7	1200	82.7	0500	1.00	25.4	.010	.019
PP-53-0500	PPB-53-0500	5/16	7.9	.188	4.8	.062	1.6	350	24.1	1400	96.4	0500	1.25	31.8	.019	.028
PP-64-0500	PPB-64-0500	3/8	9.5	.250	6.4	.062	1.6	300	20.7	1200	82.7	0500	1.25	31.8	.024	.036
PP-86-0250	PPB-86-0250	1/2	12.7	.375	9.5	.062	1.6	225	15.5	900	62.1	0250	2.50	63.5	.033	.049
PP-108-0100	PPB-108-0100	5/8	15.9	.500	12.7	.062	1.6	175	12.1	700	48.3	0100	4.00	101.6	.042	.062



For detailed ordering information, please consult price list or contact Parflex® Division.

Parker Hannifin Corporation | Parflex® Division | Ravenna, Ohio | parker.com/pfd

www.comoso.com

Order Information

Example: PP-86-0250

PP-86-0250 – Polypropylene

PP-86-0250 – **Tube O.D.** in sixteenths of an inch (**1/2"**)

PP-86-0250 – **Tube I.D.** in sixteenths of an inch (**.375"**)

PP-86-0250 – **Package Quantity** in feet (**250'**)

Polypropylene Tubing (Series PP & PPB)

Maximum Working Pressure (psig)

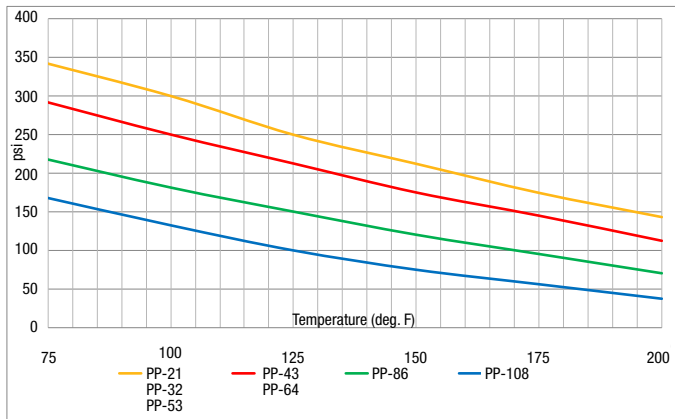

Fittings

Parker fittings available from:
 Fluid System Connectors Division
 Otsego, MI
 (269) 692-6555
 (269) 694-4614 FAX

FSC Product Families:

- Compression
- Compress-Align®
- Poly-Tite
- Hi-Duty
- Fast & Tite
- Prestolok Brass
- Liquifit
- TrueSeal™

A tube support should be used with this tubing for maximum holding power where end loading, vibration or pressure spikes may occur. Reference Tubing/Fitting Compatibility Chart (pg. B-6)

Notes

- NSF black polypropylene tubing is available upon special request. Add -FDA suffix to PPB part number
- Suggested operating temperature range for service at rated pressures with compatible fluids is 0°F to +200°F (-18°C to +93°C)

Colors

- White
- Black

For detailed ordering information, please consult price list or contact Parflex® Division.

Parker Hannifin Corporation | Parflex® Division | Ravenna, Ohio | parker.com/pfd

www.comoso.com



B-33

A Hose

B Tubing Thermoplastic

C Coiled Air Hose & Fittings

D Transportation

E Fittings

F Tooling, Equipment & Accessories

G General Technical

Polyurethane Tubing

Series U: Polyether Base



Features

- 90 to 95 Shore A durometer
- Excellent kink and abrasion resistance
- Excellent hydrolytic stability
- Flexible and easy to assemble onto designated fittings
- Polyurethane tubing exhibits the elongation and recovery characteristics of rubber and the chemical resistance associated with plastics

Applications/Markets



- Pneumatic controls
- Robotics
- Machine tools

- Analytical instrumentation
- Semiconductor equipment
- Medical and laboratory applications



- General pneumatics
- Vacuum equipment

Part Number	Tube O.D.		Tube I.D.		Average Wall Thickness		Working Pressure at 73°F / 23°C		Minimum Burst at 73°F / 23°C		Reel Length	Weight	
	inch	mm	inch	mm	inch	mm	psi	bar	psi	bar		feet	lbs./ft.
#													
U-21-XXXX	1/8	3.2	.063	1.6	.031	0.79	125	8.6	375	25.9	0050, 0250, 0500, 1000	.005	.007
U-32-XXXX	3/16	4.8	.125	3.2	.031	0.79	125	8.6	375	25.9	0050, 0250, 0500	.008	.012
U-42-XXXX	1/4	6.4	.125	3.2	.063	1.6	125	8.6	375	25.9	0050, 0250, 0500, 1000	.018	.027
U-64-XXXX	3/8	9.5	.250	6.4	.063	1.6	125	8.6	375	25.9	0050, 0250, 0500, 1000	.030	.045
U-85-XXXX	1/2	12.7	.328	8.3	.086	2.2	125	8.6	375	25.9	0050, 0250, 0500	.044	.065
U-86-XXXX	1/2	12.7	.375	9.5	.063	1.6	85	5.9	255	17.6	0050, 0250, 0500	.042	.062
U-96-XXXX	9/16	14.3	.375	9.5	.094	2.4	125	8.6	375	25.9	0050, 0100	.068	.101
U-128-XXXX	3/4	19.1	.500	12.7	.125	3.2	125	8.6	375	25.9	0050, 0100	.120	.179

Also available in coils



For detailed ordering information, please consult price list or contact Parflex® Division.

Parker Hannifin Corporation | Parflex® Division | Ravenna, Ohio | parker.com/pfd

www.comoso.com

Order Information

Example: U-21-BLK-0500

U-21-BLK-0500 – Polyurethane

U-**21**-BLK-0500 – **Tube O.D.** in sixteenths of an inch (**1/8"**)

U-**21**-BLK-0500 – **Tube I.D.** in sixteenths of an inch (**.063"**)

U-21-**BLK**-0500 – **Color (Black)** (Omit for Natural)

U-21-BLK-**0500** – **Package Quantity** in feet (**500'**)

Opaque Color Code		
○	-	Natural
●	BLK	Black
●	BLU	Blue
●	GRA	Gray
●	GRN	Green
●	ORG	Orange
●	RED	Red
○	WHT	White
●	YEL	Yellow

Transparent Color Code		
●	TBLU	Transparent Blue
●	TGRN	Transparent Green
●	TORG	Transparent Orange
●	TRED	Transparent Red
●	TYEL	Transparent Yellow

Polyurethane Tubing (Series U)

Maximum Working Pressure (psig)

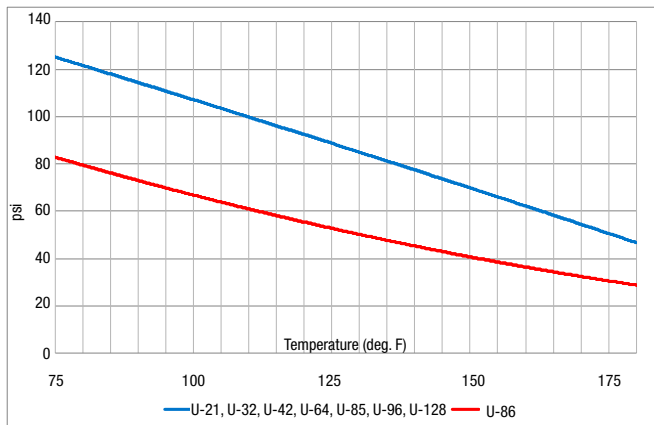

Fittings

Parker fittings available from:
Fluid System Connectors Division
Otsego, MI
(269) 692-6555
(269) 694-4614 FAX

FSC Product Families:

- Fast & Tite
- Flow Control
- Prestolok Brass
- Prestolok Composite
- TrueSeal™
- Par-Barb®

A tube support should be used with this tubing for maximum holding power where end loading, vibration or pressure spikes may occur. Reference Tubing/Fitting Compatibility Chart (pg. B-6)

Notes

- Suggested operating temperature range for service at rated pressures with compatible fluids is -40°F to +180°F (-40°C to +82°C)

Colors

- See Color Code Table

For detailed ordering information, please consult price list or contact Parflex® Division.

Parker Hannifin Corporation | Parflex® Division | Ravenna, Ohio | parker.com/pfd

www.comoso.com



B-35

A Hose

Tubing
Thermoplastic
B

Coiled Air Hose
& Fittings
C

D Transportation

F Fittings

Tooling, Equipment
& Accessories
F

General Technical
G

Metric Polyurethane Tubing

Series UM: Polyether Base

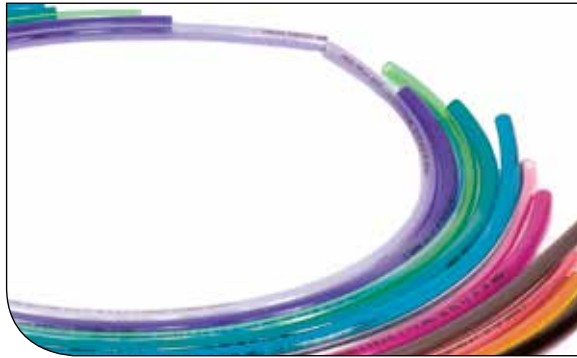

Features

- 90 to 95 Shore A durometer
- Excellent kink and abrasion resistance
- Excellent hydrolytic stability
- Flexible and easy to assemble onto designated fittings
- Polyurethane tubing exhibits the elongation and recovery characteristics of rubber and the chemical resistance associated with plastics

Applications/Markets



- Pneumatic controls
- Robotics
- Machine tools

- Analytical instrumentation
- Semiconductor equipment
- Medical and laboratory applications



- General pneumatics
- Vacuum equipment

Part Number	Tube O.D.		Tube I.D.		Average Wall Thickness		Working Pressure at 73°F /23°C		Minimum Burst at 73°F /23°C		Reel Length	Weight	
	mm	inch	mm	inch	mm	inch	bar	psi	bar	psi		feet	kg./mtr.
#													
Natural	mm	inch	mm	inch	mm	inch	bar	psi	bar	psi	feet	kg./mtr.	lbs./ft.
UM4x2.5-XXXX	4	.157	2.5	.098	0.75	.030	9.0	131	26.0	377	0100, 0250, 0500	.009	.006
UM6x4-XXXX	6	.236	4.0	.157	1.00	.039	9.0	131	26.0	377	0100, 0250, 0500	.018	.012
UM8x5-XXXX	8	.315	5.0	.196	1.50	.059	9.0	131	26.0	377	0100, 0250, 0500	.036	.024
UM10x6.5-XXXX	10	.393	6.5	.256	1.75	.069	9.0	131	26.0	377	0100, 0250	.053	.036
UM12x8-XXXX	12	.472	8.0	.315	2.00	.079	9.0	131	26.0	377	0100, 0250	.073	.049

Order Information

Example: UM6x4-BLK-0100

UM6X4-BLK-0100 – Polyurethane Metric

UM6X4-BLK-0100 – **Tube O.D.** in millimeters (**6 mm**)

UM6X4-BLK-0100 – **Tube I.D.** in millimeters (**4 mm**)

UM6X4-**BLK**-0100 – **Color (Black)** (Omit for Natural)

UM6X4-BLK-**0100** – **Package Quantity** in feet (**100'**)

Opaque Color Code		
○	-	Natural
●	BLK	Black
●	BLU	Blue
●	GRA	Gray
●	GRN	Green
●	ORG	Orange
●	RED	Red
●	YEL	Yellow

Transparent Color Code		
●	TBLU	Transparent Blue
●	TGRN	Transparent Green
●	TORG	Transparent Orange
●	TRED	Transparent Red
●	TYEL	Transparent Yellow

Fittings

Parker fittings available from:
Fluid System Connectors Division
Otsego, MI
(269) 692-6555
(269) 694-4614 FAX

FSC Product Families:

- Prestolok Brass
- Par-Barb

A tube support should be used with this tubing for maximum holding power where end loading, vibration or pressure spikes may occur. Reference Tubing/Fitting Compatibility Chart (pg. B-6)

Notes

- The recommended operating temperature range for service at rated pressures with compatible fluids is -40°F to +180°F (-40°C to +82°C)

Colors

- See Color Code Table

Metric Polyurethane Tubing (Series UM)

Maximum Working Pressure (bar)

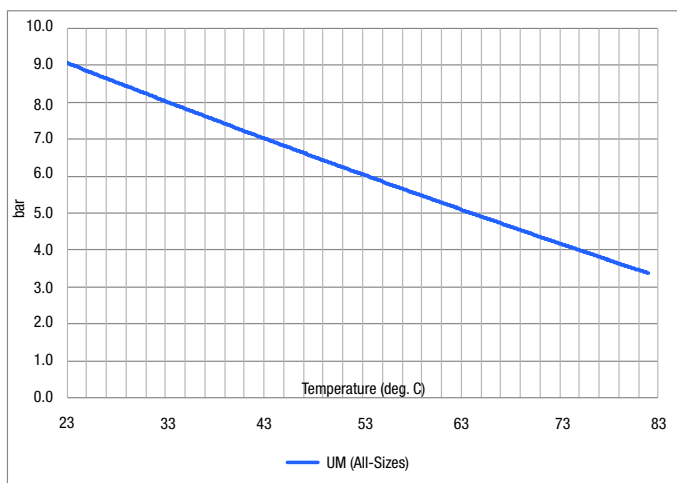

For detailed ordering information, please consult price list or contact Parflex® Division.

HUFR MicroWeld™ Tubing

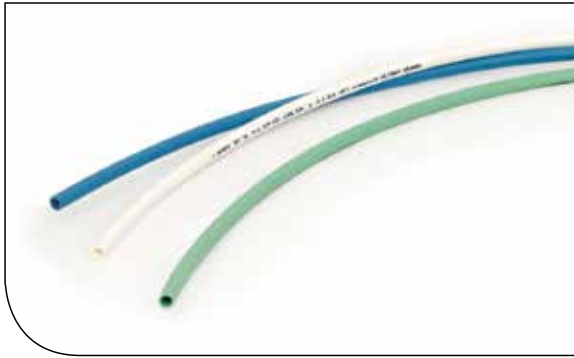

Features

- Mono-wall construction eliminates the need for skiving tools or knives, reducing installation time
- Excellent abrasion resistance
- Silicone and halogen free
- Weighs 36% less than equivalent covered tubing

Certifications

- UL 94 V2 compliant

Applications/Markets



- Robotics
- Welding
- General automation

Part Number	Tube O.D.		Tube I.D.		Average Wall Thickness		Working Pressure at 73°F / 23°C		Minimum Burst at 73°F / 23°C		Reel Length	Minimum Bend Radius		Weight	
	inch	mm	inch	mm	inch	mm	psi	bar	psi	bar		feet	inch	mm	lbs./ft.
#															
HUFR-4-045-XX-0500	1/4	6.4	.160	4.1	.045	1.1	175	12.1	525	36.2	0500	.50	12.7	.016	.024
HUFR-6-062-XX-0500	3/8	9.5	.251	6.4	.062	1.6	150	10.3	450	31.0	0500	.75	19.1	.033	.049
HUFR-8-090-XX-0250	1/2	12.7	.320	8.1	.090	2.3	160	11.0	475	32.7	0250	1.00	25.4	.063	.094

Order Information

Example: HUFR-4-045-BL-0500

HUFR-4-045-BL-0500 – MicroWeld™ Polyurethane

HUFR-**4**-045-BL-0500 – **Tube O.D.** in sixteenths of an inch (**1/4"**)

HUFR-4-**045**-BL-0500 – **Wall Thickness** in inches (**.045"**)

HUFR-4-045-**BL**-0500 – **Color (Blue)**

HUFR-4-045-BL-**0500** – **Package Quantity** in feet (**500'**)

Color Code		
●	BK	Black
●	BL	Blue
●	GN	Green
●	RD	Red
○	WH	White

Fittings

Parker fittings available from:
Fluid System Connectors Division
Otsego, MI
(269) 692-6555
(269) 694-4614 FAX

FSC Product Families:

- Prestolok PLM

Notes

- Suggested operating temperature range for service at rated pressures with compatible fluids is -40°F to +180°F (-40°C to +82°C)

Colors

- See Color Code Table

MicroWeld™ Tubing (Series HUFR)

Maximum Working Pressure (psig)

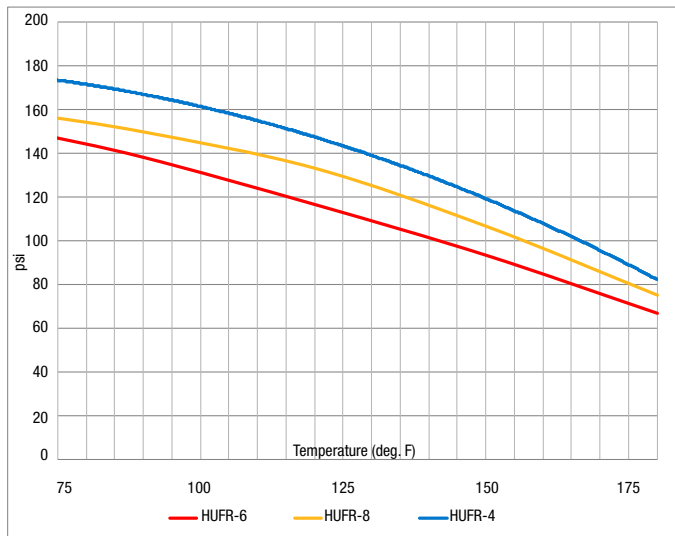

For detailed ordering information, please consult price list or contact Parflex® Division.

Polyurethane Tubing

Series HU: High Durometer Polyether Base



Features

- 95 Shore A durometer or greater
- Excellent kink and abrasion resistance
- Excellent hydrolytic stability
- Flexible and easy to assemble onto designated fittings
- Polyurethane tubing exhibits the elongation and recovery characteristics of rubber and the chemical resistance associated with plastics

Applications/Markets



- Pneumatic controls
- Robotics
- Machine tools

- Analytical instrumentation
- Semiconductor equipment
- Medical and laboratory applications



- General pneumatics
- Vacuum equipment

Part Number	Tube O.D.		Tube I.D.		Average Wall Thickness		Working Pressure at 73°F / 23°C		Minimum Burst at 73°F / 23°C		Reel Length	Weight	
	inch	mm	inch	mm	inch	mm	psi	bar	psi	bar		feet	lbs./ft.
#													
HU-2-XXXX	1/8	3.2	.063	1.6	.031	0.79	300	20.7	900	62.1	0100, 0250, 0500	.005	.007
HU-2.5-XXXX	5/32	4.0	.094	2.4	.031	0.79	210	14.5	630	43.4	0100, 0500	.006	.009
HU-4-XXXX	1/4	6.4	.160	4.1	.045	1.1	180	12.4	540	37.2	0100, 0500	.014	.021
HU-6-XXXX	3/8	9.5	.250	6.4	.062	1.6	180	12.4	540	37.2	0100, 0500	.030	.045
HU-8-XXXX	1/2	12.7	.320	8.1	.090	2.3	180	12.4	540	37.2	0100, 0250	.057	.085
HU-12-XXXX	3/4	19.1	.467	11.9	.142	3.6	180	12.4	540	37.2	0100, 0250	.133	.198

Order Information

Example: HU-2-BLK-0500

HU-2-BLK-0500 – High Durometer Polyurethane

HU-2-BLK-0500 – **Tube O.D.** in sixteenths of an inch **(1/8")**

HU-2-**BLK**-0500 – **Color (Black)**

HU-2-BLK-**0500** – **Package Quantity** in feet **(500')**

Color Code		
●	BLK	Black
●	BLU	Blue
●	DBL	Dark Blue
●	RED	Red
●	YEL	Yellow

Polyurethane Tubing (Series HU)

Maximum Working Pressure (psig)

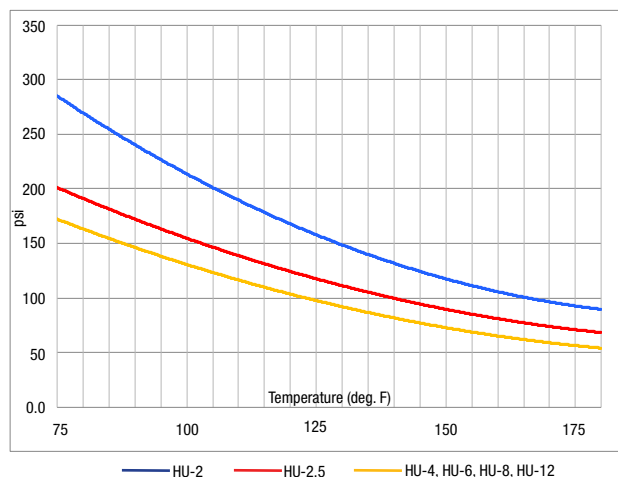

Fittings

Parker fittings available from:
Fluid System Connectors Division
Otsego, MI
(269) 692-6555
(269) 694-4614 FAX

FSC Product Families:

- Fast & Tite
- Flow Control
- Prestolok Brass
- Prestolok Composite
- TrueSeal™

A tube support should be used with this tubing for maximum holding power where end loading, vibration or pressure spikes may occur. Reference Tubing/Fitting Compatibility Chart (pg. B-6)

Notes

- Suggested operating temperature range for service at rated pressures with compatible fluids is -40°F to +180°F (-40°C to +82°C)

Colors

- See Color Code Table

For detailed ordering information, please consult price list or contact Parflex® Division.

Parker Hannifin Corporation | Parflex® Division | Ravenna, Ohio | parker.com/pfd

www.comoso.com



Metric Polyurethane Tubing

Series HUM: High Durometer (Metric) Polyether Base



Features

- 95 Shore A durometer or greater
- Excellent kink and abrasion resistance
- Excellent hydrolytic stability
- Flexible and easy to assemble onto designated fittings
- Polyurethane tubing exhibits the elongation and recovery characteristics of rubber and the chemical resistance associated with plastics

Applications/Markets



- Pneumatic controls
- Robotics
- Machine tools

- Analytical instrumentation
- Semiconductor equipment
- Medical and laboratory applications



- General pneumatics
- Vacuum equipment

Part Number	Tube O.D.		Tube I.D.		Average Wall Thickness		Working Pressure at 73°F / 23°C		Minimum Burst at 73°F / 23°C		Reel Length	Weight	
	mm	inch	mm	inch	mm	inch	bar	psi	bar	psi		feet	kg./mtr.
#													
HUM-4-XXXX	4	.157	2.4	.094	0.80	.031	12.4	180	37.2	540	0100, 0500	.009	.006
HUM-6-XXXX	6	.236	4.0	.157	1.00	.039	12.4	180	37.2	540	0100, 0500	.018	.012
HUM-8-XXXX	8	.315	5.0	.196	1.50	.059	12.4	180	37.2	540	0100, 0500	.036	.024
HUM-10-XXXX	10	.393	6.5	.256	1.75	.069	12.4	180	37.2	540	0100, 0250	.053	.036
HUM-12-XXXX	12	.472	8.0	.315	2.00	.079	12.4	180	37.2	540	0100, 0250	.073	.049



For detailed ordering information, please consult price list or contact Parflex® Division.

Parker Hannifin Corporation | Parflex® Division | Ravenna, Ohio | parker.com/pfd

www.comoso.com

Order Information

Example: HUM-6-BLK-0100

HUM-6-BLK-0100 – High Durometer Metric Polyurethane

HUM-6-BLK-0100 – **Tube O.D.** in millimeters (**6mm**)

HUM-6-**BLK**-0100 – **Color (Black)**

HUM-6-BLK-**0100** – **Package Quantity** in feet (**100'**)

Metric Polyurethane Tubing (Series HUM)

Maximum Working Pressure (bar)

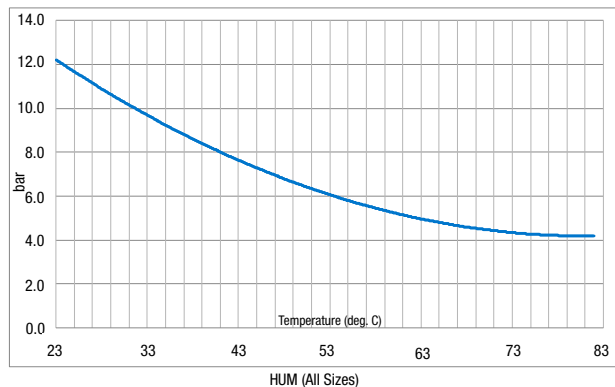

Fittings

Parker fittings available from:
Fluid System Connectors Division
Otsego, MI
(269) 692-6555
(269) 694-4614 FAX

FSC Product Families:

- Flow Control
- Prestolok Brass
- Prestolok Composite

A tube support should be used with this tubing for maximum holding power where end loading, vibration or pressure spikes may occur. Reference Tubing/Fitting Compatibility Chart (pg. B-6)

Notes

- Suggested operating temperature range for service at rated pressures with compatible fluids is -40°F to +180°F (-40°C to +82°C)

Colors

- Natural
- Black

For detailed ordering information, please consult price list or contact Parflex® Division.

Parker Hannifin Corporation | Parflex® Division | Ravenna, Ohio | parker.com/pfd

www.comoso.com



B-43

A
Hose

B
Tubing
Thermoplastic

C
Coiled Air Hose
& Fittings

D
Transportation

E
Fittings

F
Tooling, Equipment
& Accessories

G
General Technical

Vinyl Tubing

Series PV: Clear Vinyl Tubing



Features

- Made from a virgin clear PVC (polyvinyl chloride) resin; specifically formulated for exceptional purity, clarity and flexibility
- 70 durometer for soft, easy handling and bending without tubing collapse

Certifications

- FDA compliant

Applications/Markets



- Low-pressure chemicals
- Pneumatics
- Low-pressure sight flow indicator

Order Information

Example: PV108-1

PV108-1 – Poly-Vinyl Tubing

PV108-1 – **Tube O.D.** in sixteenths of an inch (**5/8"**)

PV108-1 – **Tube I.D.** in sixteenths of an inch (**1/2"**)

PV108-1 – **Formula V-1 FDA Approved Formulation**

Fittings

Parker fittings available from:
Fluid System Connectors Division
Otsego, MI
(269) 692-6555
(269) 694-4614 FAX

FSC Product Families:

- Poly-Tite
- Fast & Tite
- TrueSeal™
- Par-Barb®
- Hose Barb
- Garden Fitting

A tube support should be used with this tubing for maximum holding power where end loading, vibration or pressure spikes may occur. Reference Tubing/Fitting Compatibility Chart (pg. B-6)

Notes







- Formula V-1 tubing fully meets all specifications called out by the United States Food and Drug Administration (FDA) for materials in contact with food and drugs for human consumption
- Suggested operating temperature range for service at rated pressures with compatible fluids is -40°F to +150°F (-40°C to +65°C)



For detailed ordering information, please consult price list or contact Parflex® Division.

Parker Hannifin Corporation | Parflex® Division | Ravenna, Ohio | parker.com/pfd

www.comoso.com

Part Number	Tube O.D.		Tube I.D.		Average Wall Thickness		Working Pressure at 73°F / 23°C		Std. Coil	Weight	
	inch	mm	inch	mm	inch	mm	psi	bar		feet	lbs./ft.
#											
PV21-1	1/8	3.2	.063	1.6	.031	.79	35	2.4	100	.005	.007
PV32-1	.170	4.3	.125	3.2	.025	.64	35	2.4	100	.006	.009
PV42-1	1/4	6.4	.125	3.2	.063	1.6	65	4.5	100	.025	.037
PV43-1	1/4	6.4	.170	4.3	.040	1.2	55	3.8	100	.014	.021
PV403-1	1/4	6.4	.188	4.8	.031	.79	22	1.5	100	.011	.016
PV53-1	5/16	7.9	.188	4.8	.063	1.6	55	3.8	100	.025	.037
PV63-1	3/8	9.5	.188	4.8	.094	2.4	65	4.5	100	.043	.064
PV73-1	7/16	11.1	.188	4.8	.125	3.2	75	5.2	100	.063	.094
PV54-1	5/16	7.9	.250	6.4	.031	.79	20	1.4	100	.014	.021
PV64-1	3/8	9.5	.250	6.4	.064	1.6	55	3.8	100	.032	.048
PV74-1	7/16	11.1	.250	6.4	.094	2.4	60	4.1	100	.052	.077
PV84-1	1/2	12.7	.250	6.4	.125	3.2	70	4.8	100	.076	.113
PV75-1	7/16	11.1	.313	7.9	.063	1.6	50	3.4	100	.038	.057
PV85-1	1/2	12.7	.313	7.9	.094	2.4	60	4.1	100	.062	.092
PV95-1	9/16	14.3	.313	7.9	.125	3.2	70	4.8	100	.088	.131
PV86-1	1/2	12.7	.375	9.5	.063	1.6	45	3.1	100	.044	.065
PV96-1	9/16	14.3	.375	9.5	.094	2.4	50	3.4	100	.071	.106
PV106-1	5/8	15.9	.375	9.5	.125	3.2	60	4.1	100	.101	.150
PV97-1	9/16	14.3	.438	11.1	.063	1.6	40	2.8	100	.050	.074
PV107-1	5/8	15.9	.438	11.1	.094	2.4	45	3.1	100	.080	.119
PV117-1	11/16	17.5	.438	11.1	.125	3.2	50	3.4	100	.115	.171
PV108-1	5/8	15.9	.500	12.7	.063	1.6	30	2.1	100	.057	.085
PV118-1	11/16	17.5	.500	12.7	.094	2.4	40	2.8	100	.089	.132
PV128-1	3/4	19.1	.500	12.7	.125	3.2	45	3.1	100	.126	.187
PV138-1	13/16	20.7	.500	12.7	.156	4.0	60	4.1	100	.167	.248
PV129-1	3/4	19.1	.563	14.3	.094	2.4	40	2.8	100	.099	.147
PV139-1	13/16	20.7	.563	14.3	.125	3.2	45	3.1	100	.138	.205

For detailed ordering information, please consult price list or contact Parflex® Division.



Vinyl Tubing (cont.)

Series PV: Clear Vinyl Tubing

Part Number	Tube O.D.		Tube I.D.		Average Wall Thickness		Working Pressure at 73°F / 23°C		Std. Coil	Weight	
	inch	mm	inch	mm	inch	mm	psi	bar		feet	lbs./ft.
#											
PV1310-1	13/16	26.7	.625	15.9	.094	2.4	35	2.4	100	.108	.161
PV1410-1	7/8	22.2	.625	15.9	.125	3.2	40	2.8	100	.151	.225
PV1510-1	15/16	23.8	.625	15.9	.156	4.0	50	3.5	100	.196	.292
PV1411-1	7/8	22.2	.688	17.5	.094	2.4	30	2.1	100	.118	.176
PV1611-1	1	25.4	.688	17.5	.156	4.0	45	3.1	100	.213	.317
PV1612-1	1	25.4	.750	19.1	.125	3.2	35	2.4	100	.176	.262
PV1712-1	1-1/16	27.0	.750	19.1	.156	4.0	35	2.4	100	.228	.339
PV1812-1	1-1/8	28.6	.750	19.1	.188	4.8	50	3.5	100	.283	.421
PV2012-1	1-1/4	31.8	.750	19.1	.250	6.4	55	3.8	50	.409	.609
PV1814-1	1-1/8	27.0	.875	22.2	.125	3.2	30	2.1	50	.201	.299
PV1914-1	1-3/16	30.2	.875	22.2	.156	4.0	35	2.4	100	.259	.385
PV2014-1	1-1/4	31.8	.875	22.2	.188	4.8	45	3.1	50	.321	.478
PV2016-1	1-1/4	31.8	1.000	25.4	.125	3.2	25	1.7	50	.230	.342
PV2116-1	1-5/16	33.4	1.000	25.4	.156	4.0	30	2.1	50	.291	.433
PV2216-1	1-3/8	34.9	1.000	25.4	.188	4.8	40	2.8	50	.359	.534
PV2416-1	1-1/2	38.1	1.000	25.4	.250	6.4	45	3.1	50	.514	.765
PV2218-1	1-3/8	34.9	1.125	28.6	.125	3.2	25	1.7	50	.252	.375
PV2420-1	1-1/2	38.1	1.250	31.8	.125	3.2	20	1.4	50	.277	.412
PV2620-1	1-5/8	41.3	1.250	31.8	.188	4.8	35	2.4	50	.434	.646
PV2820-1	1-3/4	44.4	1.250	31.8	.250	6.4	45	3.1	50	.604	.899
PV3024-1	1-7/8	47.6	1.500	38.1	.188	4.8	30	2.1	50	.510	.759
PV3224-1	2	50.8	1.500	38.1	.250	6.4	40	2.8	50	.705	1.05
PV3628-1	2-1/4	57.2	1.750	44.4	.250	6.4	30	2.1	50	.806	1.20
PV4032-1	2-1/2	63.5	2.000	50.8	.250	6.4	35	2.4	50	.906	1.35

Fluoropolymer Tubing

Fluoropolymer Tubing

Fluoropolymer tubing features a low coefficient of friction and anti-stick properties, high temperature capabilities and the most corrosion and chemical resistance of all polymers. Within normal use temperatures, fluoropolymers are attacked by so few chemicals that it is easier to describe the exceptions rather than list the chemicals they are compatible with (see Chemical Resistance Summary, pg. B-50). These chemically inert tubes are non-wetting and non-leaching, making them ideal for a wide range of fluid and material handling applications.

Parker fluoropolymer tubing is available in PTFE, FEP, PFA and PVDF with some materials operating at temperatures up to 500°F (260°C). Each material has specific dominant characteristics, but all operate in high-temperature, corrosive environments.

- Parflex PTFE, FEP, PFA and PVDF tubing complies with European Standard RoHs and are also FDA compliant to FDA regulation 21 CFR 177.1550, making these products suitable for use in food and beverage applications.
- Parflex PTFE, FEP and PFA are listed VW-1 in the burning test for Underwriters Laboratories and pass the UL-83 vertical flame test. In a flame situation, PTFE, FEP and PFA tubing resist combustion and do not promote flame spread.

All fluoropolymer tubing dimensions are continuously monitored to ensure an overall quality product. Most tubing sizes are packaged in convenient 25-ft., 50-ft., 100-ft. and 1,000-ft. lengths.

PTFE

- PTFE (Polytetrafluorethylene) is offered in beading, smoothbore tubing, heat shrinkable, spiral wrap and convoluted tubing.
- PTFE tubing features unmatched chemical resistance and a non-stick surface that facilitates flow and eliminates media buildup.

FEP

- FEP (Fluorinated Ethylene Propylene) is available in smoothbore tubing, heat shrinkable, convoluted, corrugated and retractable coil tubing.
- FEP tubing offers the highest clarity in the fluoropolymer market and is a close second to PTFE in chemical resistance.
- FEP is available in long, continuous lengths (1,000 feet and longer) whereas the longest lengths for PTFE range from 200 to 1,000 feet depending on size and wall thickness.

PFA

- PFA (Perfluoroalkoxy) is available in smoothbore tubing.
- When temperature and clarity are both factors, PFA is the resin of choice because it offers the high-temperature attributes of PTFE, long continuous lengths, and almost as much clarity as FEP.
- High purity resins available.
- Low permeability.

Fluoropolymer Tubing

Product Family	Type	Series		Suggested Applications		Suggested Markets
PTFE	Beading	TFB		Pull Cord O-Ring Seals	Spacers Woven Filter	Chemical High-Temp Food Instrumentation Laboratory Gas Sampling Electrical Insulation Fluid Handling Industrial Equipment Ground Support
	Smoothbore	TFH TFS	TFT TFL	Electrical Insulation Protective Cover	Circuit Board Wire Insulation	
	Smoothbore	101	201	Electrical Insulation Fluid Transfer	Gas Sampling Laboratory	
	Heat Shrink	HS2T	HS4T TSSS/L	Electrical Insulation Protective Cover	Circuit Board Rollers	
	Convuluted	CV CVL	CVH 81914	Fluid Transport Wire Harness	Protection/Cable Core Robotics	
	Spiral Wrap	TSWTF		Cable Harnessing	Wiring closets	Aerospace Automotive
FEP	Smoothbore	103	203	Nitrogen Filling Downhole Pump Ozone Sampling	Hearing Aid Optical Sensors	UV Applications Chemical Instrumentation Laboratory Gas Dispensing Gas Sampling Robotics Fluid Handling Food & Beverage Semiconductor Pharmaceutical Electrical Industrial Equipment Medical
	Heat Shrink	HS1.3 HS1.6 HS1.25	TSSS TSSL	Protective Covering UV Light Covering Product Testing	Paper Rollers Ink Rollers	
	Convuluted	CV	81914	Fluid Transport Wire Harness	Protection/Cable Core Robotics	
	Corrugated	CR		Vacuum Applications Wet Bench DNA Sequencer	Fluid Transfer Robotics	
	Retractable	703		Lab Equipment Gas Dispensing	Wet Bench Dual Containment	
PFA	Smoothbore	104	204	Air Sampling Gas Purge Wet Bench	Flow Monitoring Steam Plant	Chemical Laboratory Semiconductor Instrumentation Food Environmental Fluid Handling Gas Service Pharmaceutical Medical
H.P. PFA	Smoothbore	105	205	Flow Monitoring Systems High Purity Apps. DI Water Dispensers	DI Recirculators Heat Exchangers Pure Chemical Dispensers	
PFA H.P. PFA	Retractable	704	705	Lab Equipment Gas Dispensing	Wet Bench Dual Containment	
PVDF	Smoothbore	110	111	Outdoor/Extreme Conditions Applications with long cycle life	Thermal Cycling Water Systems	Chemical Food Gas/Environmental

High Purity PFA

- H.P. PFA (Perfluoroalkoxy) has the highest molecular weight available.
- Withstands corrosive surfactants for longer periods of time than standard products.
- Lowest level of extractables.

PVDF

- PVDF (Polyvinylidene Fluoride) is available in flexible and super flexible smoothbore tubing.
- PVDF offers a combination of properties beneficial for use in many critical applications requiring chemical resistance with low permeability.
- PVDF exhibits low extractable levels while providing high mechanical strength and abrasion resistance.

For detailed ordering information, please consult price list or contact Parflex® Division.

Fluoropolymer Tubing

Tubing
Fluoropolymer
B

Coiled Air Hose
& Fittings
C

Transportation
D

Fittings
E

Tooling, Equipment
& Accessories
F

General Technical
G

Fluoropolymer - Quick Reference

PTFE (Polytetrafluoroethylene)

Working Temperature: 500°F (260°C)

Color: Opaque to translucent

- Chemically inert
- Lowest coefficient of friction
- Superior dielectric strength
- Exceptional heat resistance
- Self extinguishing
- Non-wetting
- Excellent flexlife
- Laser markable

PFA (Perfluoroalkoxy)

Working Temperature: 500°F (260°C)

Color: Clear with light blue or tint

- High purity resins available
- Low permeation resins available
- Use when you need the temperature range of PTFE and the clarity of FEP
- Exceptional heat resistance
- Self extinguishing
- Non-wetting
- Good flexlife

FEP (Fluorinated Ethylene Propylene)

Working Temperature: 400°F (204°C)

Color: Clear

- Excellent chemical resistance
- Non-wetting
- Weldable
- Tubes can be sealed by melting
- Long continuous lengths
- Low refractive index
- Improved clarity over PFA
- Lower cost alternative to PFA

PVDF (Polyvinylidene Fluoride)

Working Temperature: 265°F (130°C)

Color: Varies

- Very good chemical resistance
- Excellent resistance to creep and fatigue
- UV Resistant
- Weldable
- Exceptional corrosion resistance for chlorine, fluorine, or bromine environments

Chemical Resistance Summary



Within normal use temperatures, fluoroplastics are attacked by so few chemicals that it is easier to describe the exceptions rather than list the chemicals with which TexFluor™ is compatible.

DO NOT USE FLUOROPLASTICS WITH THE FOLLOWING:

- Alkali metals such as elemental sodium, potassium, lithium, etc. The alkali metals remove fluorine from the polymer molecule.
- Extremely potent oxidizers, fluorine (F₂) and related compounds (e.g., chlorine trifluoride, ClF₃). These can be handled by TexFluor™, but only with great care, as fluorine is absorbed into the resins, and the mixture becomes sensitive to a source of ignition such as impact.
- 80% NaOH (Sodium Hydroxide) or KOH (Potassium Hydroxide), metal hydrides such as Boranes (e.g., B₂H₆), Aluminum Chloride, Ammonia (NH₃), certain Amines (R-NH₂) and imines (R=NH) and 70% Nitric Acid at temperatures near the suggested service limit.



WARNING

FAILURE OR IMPROPER SELECTION OR IMPROPER USE OF THE PRODUCTS AND/OR SYSTEMS DESCRIBED HEREIN OR RELATED ITEMS CAN CAUSE DEATH, PERSONAL INJURY AND PROPERTY DAMAGE.

This document and other information from Parker Hannifin Corporation, its subsidiaries and authorized distributors provide product and/or system options for further investigation by users having technical expertise. It is important that you analyze all aspects of your application and review the information concerning the product or system in the current product catalog. Due to the variety of operating conditions and applications for these products or systems, the user, through its own analysis and testing, is solely responsible for making the final selection of the products and systems and assuring that all performance, safety and warning requirements of the application are met.

The products described herein, including without limitation, product features, specifications, designs, availability and pricing, are subject to change by Parker Hannifin Corporation and its subsidiaries at any time without notice.

Fluoropolymer Tubing

The table below lists a generally accepted summary of properties that we believe to be reliable. Please note that many of these resins are produced in several varieties and property characteristics may vary. Therefore, determination of resin is dependent on the application and this table is only meant to serve as a general guideline.

Properties*	ASTM or Unit	PTFE	FEP	PFA	High Purity PFA	PVDF	ETFE
MECHANICAL PROPERTIES							
Specific Gravity	D792 D3307	2.13-2.22 -	2.12-2.17 -	2.12-2.17 -	- 2.14-2.16	1.76-1.82 -	1.74 -
Elongation %	D638 D3307	200-450 -	250-330 -	280-400 -	- 370	100-800 -	430 -
Tensile Strength (psi)	D638(psi) D3307(psi)	2000-7000 -	2800-4000 -	4000-5000 -	- 4693	2000-5000 -	6962 -
Flexural Strength (psi)	D790	no break	no break	no break	no break	1500-5000	5500
Compressive Strength (psi)	D695	700-900	725-2200	725-810	na	2000-6000	2500
Tensile Elastic Modulus (Young's Modulus) (psi)	D638	57,000 -	50,000 -	72,500- 87,000	na	35,000-220,000	116,030
Flexural Modulus	D790(psi) D790 103MPa (103kgf/cm2)	71,000-85,000 0.5-0.6 (5.0-6.0)	78,000-92,000 0.5-0.6 (5.5-6.4)	94,000-99,000 0.6-0.7 (6.6-7.0)	- 647-686 -	90,000-168,000 280,00-110,000	130,534 - -
Flex Life (MIT cycles)	D2176	>1,000,000	5,000-80,000	10,000-500,000	2000 x 10 ³	na	na
Hardness Durometer Shore D	D2240	D50-65	D55	D55-D60	D60	D55-D75	D67
Coefficient of Friction	(on steel)	0.02	0.05	0.04-0.06	0.05	0.33-0.49	0.20
Abrasion Resistance 1000 cycles	Taber	8-90	14-20	0.00-96.75	na	16-33	0.005
Impact Strength IZOD. 73°F (23°C) notched ft/lbs/in	D256	3	no break	no break	no break	4	no break
THERMAL PROPERTIES							
Melting Point	°C °F	327 621	260 500	305 582	305 582	125 257	260 500
Upper Service Temperature(20000h)	°C °F	260 500	204 400	260 500	260 500	130 265	180 356
Flammability	UL 94	V-0	V-0	V-0	V-0	V-0	V-0
Thermal Conductivity BTU-in/hr-ft ² , °F		1.7-2.08	1.4	1.3	na	1.00-1.25	1.65
Thermal Conductivity Cal-cm/sec-cm ² , °C		6 x 10 ⁻⁴	6 x 10 ⁻⁴	6 x 10 ⁻⁶	na	na	5.7 x 10 ⁻⁴
Linear Coefficient of Thermal Expansion Min/in°F 73.4-140°F	D696	55.6	46.1-58.3	66.7	na	7.00-10.8	9.4 (10 ⁻⁵ /°C)
Heat of Fusion	BTU/LB	29-37	4-35	13	na	0.28-0.36	20
Heat of Combustion	BTU/LB °F	2200	2200	2300	na	na	8100
Low Temperature Embrittlement	°C °F	-268 -450	-268 -450	-268 -450	-268 -450	-62 -80	-76 -105
ELECTRICAL PROPERTIES							
Dielectric Constant	D150/10 ³ Hz D150/10 ⁶ Hz	2.1 2.1	2.1 2.1	2.1 2.1	2.1 2.1	3.5 10.6	2.6
Dielectric Strength	D149/125 MIL D149/10 MIL	500 ≥1400	508 >610	500 ≥1400	500 - 600 na	0.8 1.5	na
Volume Resistivity	D257/ohm-cm	>10 ¹⁸	>10 ¹⁸	>10 ¹⁸	na	2 x 10 ¹⁴	10 ¹⁷
Surface Resistivity	D257/ohm-cm	>10 ¹⁸	>10 ¹⁷	>10 ¹⁷	na	5 x 10 ¹⁴	>10 ¹⁵
GENERAL PROPERTIES							
Chemical/Solvent Resistance	D543	Excellent	Excellent	Excellent	Excellent	Very Good	Excellent
Refractive Index		1.35	1.338	1.34	1.34	1.42	1.447
Limiting Oxygen Index, %	D2868	>95	>95	≥95	na	42/75 ²	31
Water Contact Angle	Angle to Level	110	114	115	na	92	na
Water Absorption 24h,%	D570	<0.01	<0.01	<0.03	<0.01	0.03-0.05	0.03
Weatherability		Excellent	Excellent	Excellent	Excellent	Excellent	Excellent

*General resin properties; Tubing properties may vary.

Tubing Pressure Ranges

Tubing pressures vary by material, tubing size and wall thickness. Please contact Customer Service for specific pressures.

For detailed ordering information, please consult price list or contact Parflex® Division.

Parker Hannifin Corporation | Parflex® Division | Ravenna, Ohio | parker.com/pfd

www.comoso.com



B-51

Tubing
Fluoropolymer
B

Coiled Air Hose
& Fittings
C

Transportation
D

Fittings
E

Tooling, Equipment
& Accessories
F

General Technical
G

Fluoropolymer Tubing

Fluoropolymer Tubing Nomenclature Smoothbore Fractional and Metric Tubing

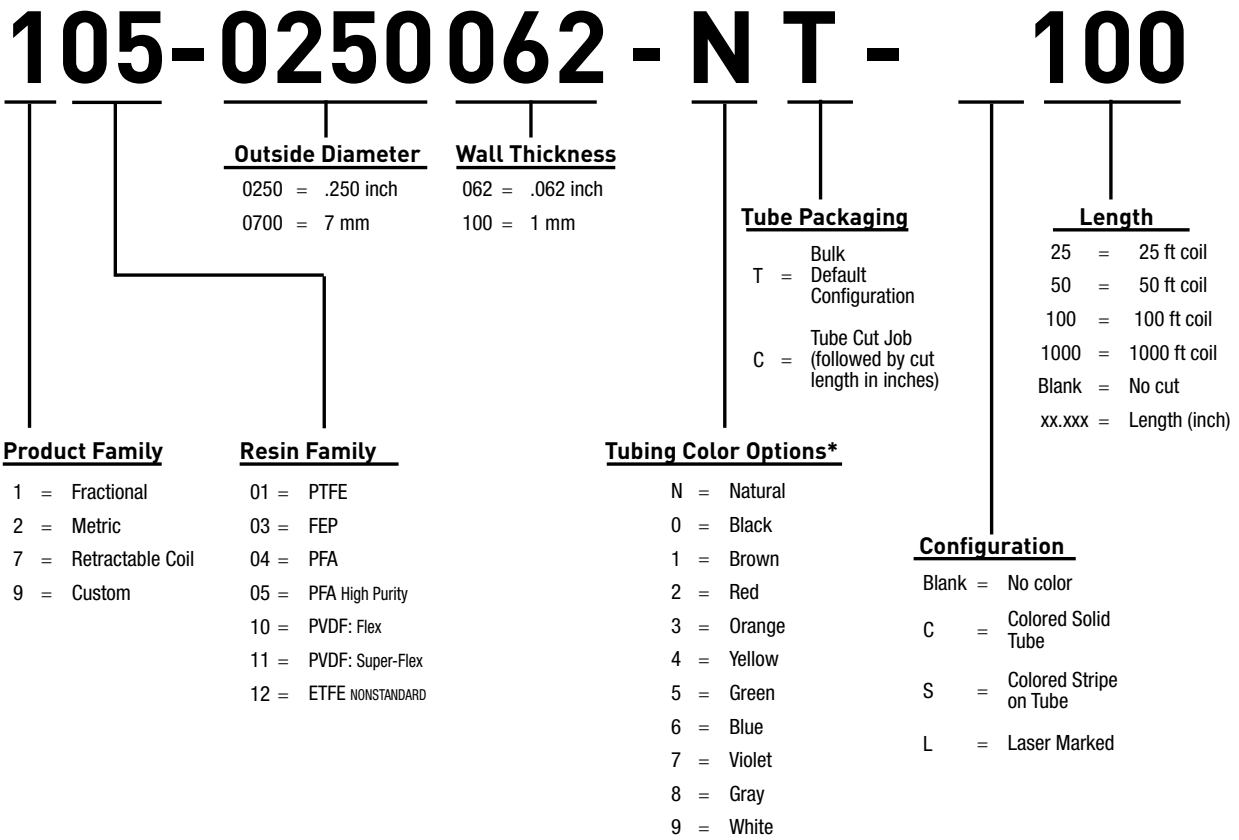

Convolute and Corrugated Tubing

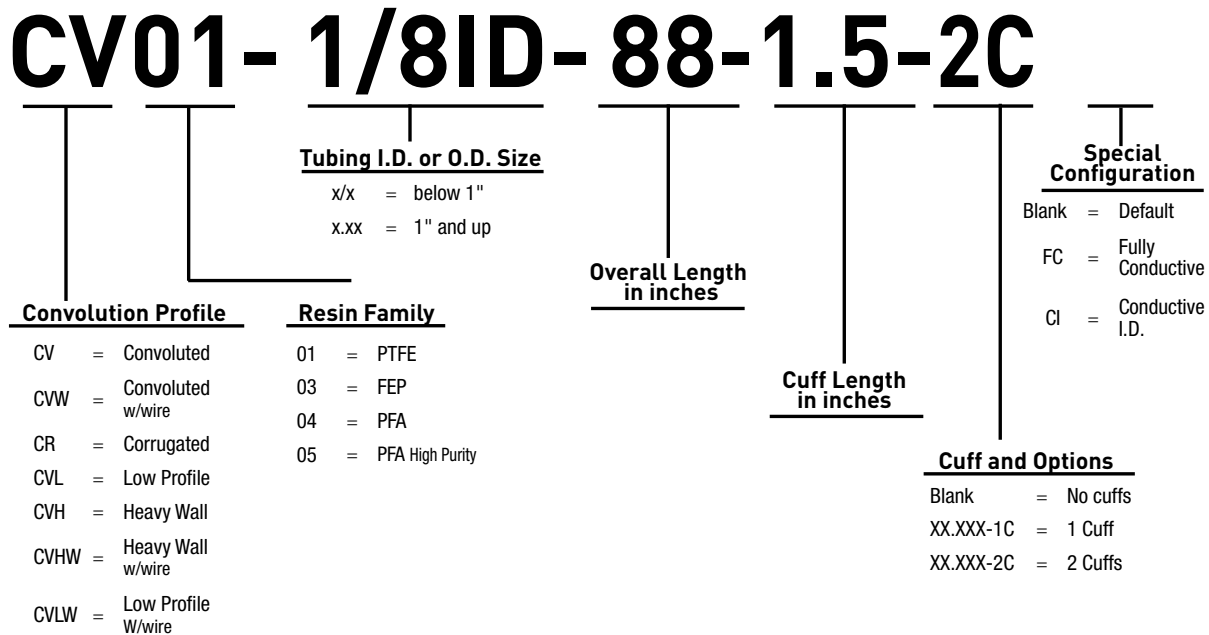

Fluoropolymer Tubing

Fluoropolymer Tubing Nomenclature

Heat Shrink, Electrical Insulation Tubing and Beading

HS2** T F T 1/8 - N T***

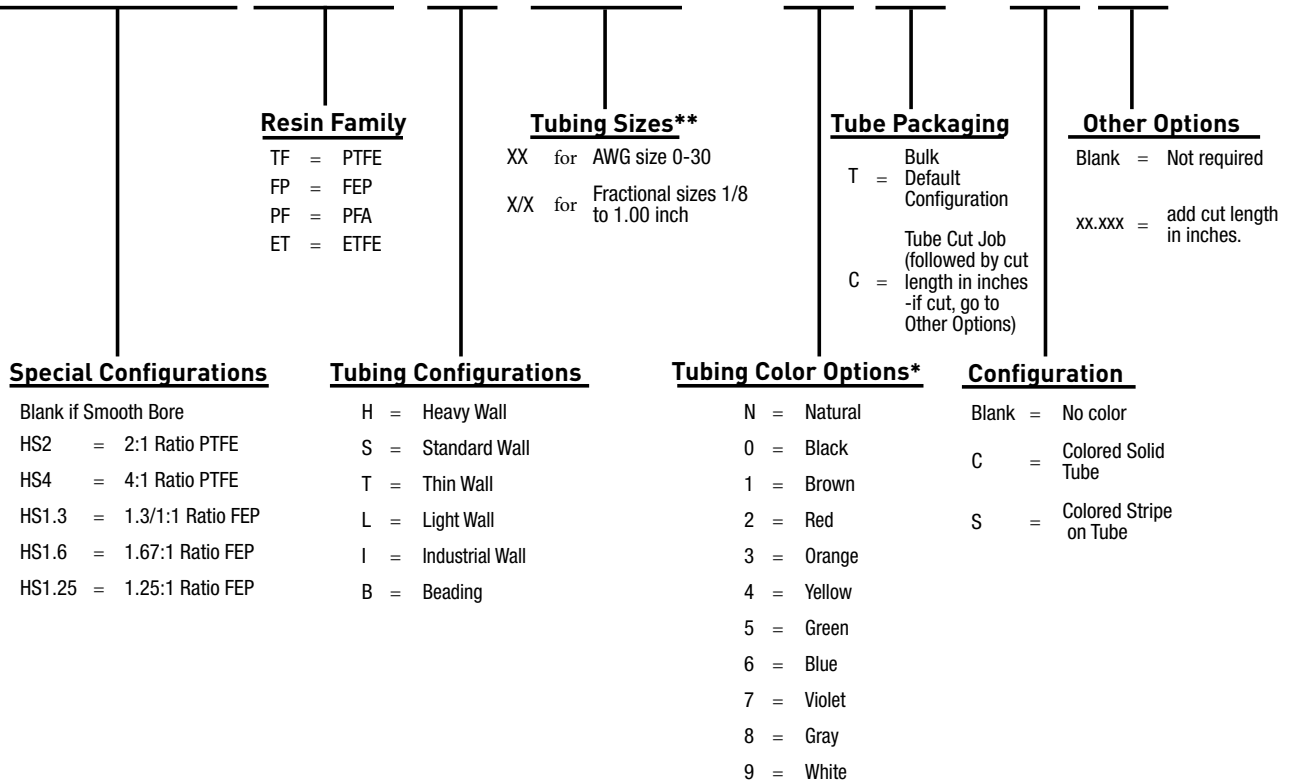

*When ordering coiled tubing in colors, the color code is always followed by TC; when ordering cut lengths, the color code is followed by CC....ie HS2TFT1/8-2TC ..ie HS1.3FEP24-0CC48.000

**This first configuration is only used for heat shrinkable tubing or spiral wrap. For example, electrical insulation tubing part number would read TFT-1/8-NT.

***When changing to cut length, replace the T with C and specify the length in inches. If this part was cut to 4 feet, part number would read TFT-1/8-NC48.000.

****Sizes for heat shrink designate the size of the heat shrink tube as stated by the applicable specification. The actual O.D. of the tubing does not always match the size. Review actual tables to see the true expanded dimension of the tube.

For detailed ordering information, please consult price list or contact Parflex® Division.

Parker Hannifin Corporation | Parflex® Division | Ravenna, Ohio | parker.com/pfd

www.comoso.com



B-53

Tubing
Fluoropolymer
B

Coiled Air Hose
& Fittings
C

Transportation
D

Fittings
E

Tooling, Equipment
& Accessories
F

General Technical
G

PTFE Tubing

Series Fractional & Metric: 101, 201



Features

- Virgin Polytetrafluoroethylene resin
- Chemically inert
- Lowest coefficient of friction
- Superior dielectric strength
- Exceptional heat resistance
- Self extinguishing
- Non-wetting
- Excellent flexlife
- Laser markable

Applications/Markets



- Cable Liner
- Electrical Insulation
- Oxygen Sensor
- Paint Transfer
- Gas Sampling
- Laboratory



Certifications/Compliance

- AMS 3653E
- VW1, UL-83 (natural)
- FDA Compliant
- USP Class VI Compliant

Order Information

Example: 101-0188062-0TC-100

101-0188062-0TC-100 – **PTFE**

101-**0188**062-0TC-100 – **Tube O.D.** in inches (**3/16"**)

101-0188**062**-0TC-100 – **Tube Wall Thickness** in inches (**.062"**)

101-0188062-**0TC**-100 – **Black**

101-0188062-**0TC**-100 – **Bulk Tubing**

101-0188062-**0TC**-100 – **Solid Color Tube**

101-0188062-0TC-**100** – **Package Quantity** in feet (**100'**)

Notes

- Working Temperature: 500°F (260°C)
- Working pressure calculated using a Design Factor of 4
- Custom packaging and sizes are quoted upon request
- Package quantities are not continuous

Colors

- ○ Natural, Translucent
- Colors available as custom run, see color code table

Fittings

Fittings available for sizes 3/32" up to 1.1"

Parker Fittings available from:
Fluid System Connectors Division
Otsego, MI

(269) 694-2550

(269) 692-6634 FAX

FSC Product Families:

- Compression
- Compress-Align®
- TrueSeal™

Color Code					
○	N	Natural	●	5	Green
●	0	Black	●	6	Blue
●	1	Brown	●	7	Violet
●	2	Red	●	8	Gray
●	3	Orange	○	9	White
●	4	Yellow			

101 PTFE Industrial Wall Fractional Size Tubing

Part Number	Order Size	Nominal O.D.				Nominal I.D.				Reference Wall		Working Pressure		Burst Pressure		Min. Bend Radius		Vac. Rating		Weight	
		inch	inch	tol.	mm	tol.	inch	tol.	mm	tol.	inch	mm	psi 73°F	bar 23°C	psi 73°F	bar 23°C	inch	mm	at 73°F	lb. per ft.	kg. per m.
#																					
101-0094031	3/32	0.094	± 0.005	2.40	± 0.13	0.031	± 0.002	0.79	± 0.05	0.031	0.79	390	27	1560	108	0.500	13	28	0.006	0.009	
101-0125031	1/8	0.125	± 0.005	3.18	± 0.13	0.063	± 0.003	1.57	± 0.05	0.031	0.79	290	20	1160	80	0.500	13	28	0.009	0.013	
101-0156031	5/32	0.156	± 0.005	3.99	± 0.13	0.094	± 0.004	2.39	± 0.08	0.031	0.79	220	15	880	61	0.625	16	28	0.011	0.017	
101-0188031	3/16	0.188	± 0.005	4.78	± 0.13	0.125	± 0.005	3.18	± 0.13	0.031	0.79	180	12	720	50	0.750	19	28	0.014	0.021	
101-0250031	1/4	0.250	± 0.005	6.35	± 0.13	0.190	± 0.005	4.83	± 0.13	0.031	0.79	130	9	520	36	1.000	25	28	0.020	0.030	
101-0312031	5/16	0.312	± 0.005	7.92	± 0.13	0.250	± 0.007	6.35	± 0.18	0.031	0.79	100	7	400	28	2.250	57	28	0.026	0.038	
101-0375031	3/8	0.375	± 0.005	9.52	± 0.13	0.312	± 0.006	7.92	± 0.15	0.031	0.79	80	6	320	22	2.750	70	28	0.032	0.047	
101-0438031	7/16	0.438	± 0.005	11.13	± 0.13	0.375	± 0.007	9.52	± 0.18	0.031	0.79	70	5	280	19	4.000	102	28	0.037	0.056	
101-0500031	1/2	0.500	± 0.006	12.70	± 0.15	0.438	± 0.008	11.13	± 0.20	0.031	0.79	60	4	240	17	4.000	102	28	0.043	0.064	
101-0563031	9/16	0.563	± 0.007	14.30	± 0.18	0.500	± 0.010	12.70	± 0.25	0.031	0.79	55	4	220	15	5.000	127	28	0.049	0.073	
101-0625031	5/8	0.625	± 0.007	15.88	± 0.18	0.563	± 0.010	14.30	± 0.25	0.031	0.79	50	3	200	14	5.500	140	28	0.054	0.081	
101-0688031	11/16	0.688	± 0.010	17.48	± 0.25	0.625	± 0.012	15.88	± 0.31	0.031	0.79	45	3	180	12	6.250	159	28	0.060	0.090	
101-0750032	3/4	0.750	± 0.010	19.05	± 0.25	0.688	± 0.012	17.48	± 0.31	0.032	0.81	40	3	160	11	6.500	165	28	0.068	0.101	
101-0830040	0.830	0.830	± 0.014	21.08	± 0.36	0.750	± 0.014	19.05	± 0.36	0.040	1.02	45	3	180	12	8.000	203	28	0.093	0.139	
101-0965045	0.965	0.965	± 0.016	24.51	± 0.41	0.875	± 0.016	22.22	± 0.41	0.045	1.14	45	3	180	12	12.000	305	28	0.122	0.182	
101-1100050	1.100	1.100	± 0.020	27.94	± 0.51	1.000	± 0.020	25.40	± 0.51	0.050	1.27	40	3	160	11	18.000	457	28	0.155	0.231	

Continued on next page

For detailed ordering information, please consult price list or contact Parflex® Division.

Parker Hannifin Corporation | Parflex® Division | Ravenna, Ohio | parker.com/pfd

www.comoso.com



PTFE Tubing

Series Fractional & Metric: 101, 201 (cont.)

101 PTFE Heavy Wall Fractional Size Tubing

Part Number	Order Size	Nominal O.D.				Nominal I.D.				Reference Wall		Working Pressure		Burst Pressure		Min. Bend Radius		Vac. Rating	Weight	
		inch	inch	tol.	mm	tol.	inch	tol.	mm	tol.	inch	mm	psi 73°F	bar 23°C	psi 73°F	bar 23°C	inch		mm	at 73°F
#																				
101-0188062	3/16	.188	±.005	4.78	±0.13	0.063	±0.003	1.57	±0.05	0.062	1.57	390	27	1560	108	0.250	6	28	0.023	0.034
101-0250047	1/4	.250	±.005	6.35	±0.13	0.157	±0.005	3.99	±0.13	0.047	1.19	210	14	840	58	0.625	16	28	0.028	0.042
101-0250062	1/4	.250	±.005	6.35	±0.13	0.125	±0.005	3.18	±0.13	0.062	1.57	290	20	1160	80	0.500	13	28	0.034	0.051
101-0312062	5/16	.312	±.005	7.92	±0.13	0.188	±0.006	4.76	±0.15	0.062	1.57	222	15	888	61	0.875	22	28	0.046	0.068
101-0375062	3/8	.375	±.005	9.52	±0.13	0.250	±0.005	6.35	±0.13	0.062	1.57	180	12	720	50	1.000	25	28	0.057	0.085
101-0438062	7/16	.438	±.005	11.13	±0.13	0.312	±0.007	7.92	±0.18	0.062	1.57	150	10	600	41	2.250	57	28	0.069	0.103
101-0500062	1/2	.500	±.005	12.70	±0.13	0.375	±0.005	9.52	±0.13	0.062	1.57	130	9	520	36	2.250	57	28	0.080	0.120
101-0563062	9/16	.563	±.007	14.30	±0.18	0.437	±0.008	11.13	±0.20	0.062	1.57	110	8	440	30	2.750	70	28	0.092	0.137
101-0625062	5/8	.625	±.007	15.88	±0.18	0.500	±0.010	12.70	±0.25	0.062	1.57	100	7	400	28	3.000	76	28	0.103	0.154
101-0688062	11/16	.688	±.010	17.48	±0.25	0.563	±0.010	14.30	±0.25	0.062	1.57	90	6	360	25	5.000	127	28	0.115	0.171
101-0750062	3/4	.750	±.010	19.05	±0.25	0.625	±0.010	15.88	±0.25	0.062	1.57	80	6	320	22	6.000	152	28	0.126	0.188
101-0875062	7/8	.875	±.014	22.22	±0.36	0.750	±0.014	19.05	±0.36	0.062	1.57	70	5	280	19	7.250	184	28	0.149	0.222
101-1000062	1	1.000	±.016	25.40	±0.25	0.875	±0.016	22.22	±0.36	0.062	1.57	100	6.9	400	28	8.000	203	28	0.172	0.256



For detailed ordering information, please consult price list or contact Parflex® Division.

Parker Hannifin Corporation | Parflex® Division | Ravenna, Ohio | parker.com/pfd

www.comoso.com

201 Metric PTFE Tubing

Part Number	Order Size	Nominal O.D.				Nominal I.D.				Reference Wall		Working Pressure		Burst Pressure		Min. Bend Radius		Vac. Rating		Weight	
		mm	mm	tol.	inch	tol.	mm	tol.	inch	tol.	mm	inch	bar 23°C	psi 73°F	bar 23°C	psi 73°F	mm	inch	at 73°F	kg. per m.	lb. per ft.
#																					
201-0300100	3	3	±0.11	0.118	±0.004	1	±0.11	0.039	±0.004	1	0.039	390	27	108	1560	13	0.500	28	0.014	0.009	
201-0400100	4	4	±0.11	0.157	±0.004	2	±0.11	0.074	±0.004	1	0.039	290	20	80	1160	13	0.500	28	0.020	0.014	
201-0500100	5	5	±0.11	0.197	±0.004	3	±0.11	0.118	±0.004	1	0.039	220	15	61	880	19	0.750	28	0.027	0.018	
201-0600100	6	6	±0.13	0.236	±0.005	4	±0.13	0.157	±0.005	1	0.039	180	12	50	720	25	1.000	28	0.034	0.023	
201-0700100	7	7	±0.13	0.276	±0.005	5	±0.13	0.197	±0.005	1	0.039	150	10	41	600	38	1.500	28	0.041	0.027	
201-0800100	8	8	±0.13	0.315	±0.005	6	±0.13	0.236	±0.005	1	0.039	130	9	36	520	51	2.000	28	0.048	0.032	
201-0900100	9	9	±0.13	0.354	±0.005	7	±0.13	0.276	±0.005	1	0.039	110	8	30	440	57	2.250	28	0.055	0.037	
201-1000100	10	10	±0.13	0.394	±0.005	8	±0.13	0.315	±0.005	1	0.039	100	7	28	400	64	2.500	28	0.061	0.041	
201-1200100	12	12	±0.15	0.472	±0.006	10	±0.15	0.394	±0.006	1	0.039	80	6	22	320	76	3.000	28	0.075	0.050	
201-1400100	14	14	±0.15	0.551	±0.006	12	±0.15	0.472	±0.006	1	0.039	70	5	19	280	89	3.500	28	0.089	0.060	
201-1600100	16	16	±0.15	0.630	±0.006	14	±0.15	0.551	±0.006	1	0.039	60	4	17	240	108	4.250	28	0.102	0.069	

For detailed ordering information, please consult price list or contact Parflex® Division.

Parker Hannifin Corporation | Parflex® Division | Ravenna, Ohio | parker.com/pfd

www.comoso.com



B-57

PTFE Tubing

Series Fractional: TFL, TFS, TFT



Features

- Virgin Polytetrafluoroethylene resin
- Chemically inert
- Lowest coefficient of friction
- Superior dielectric strength
- Exceptional heat resistance
- Self extinguishing
- Non-wetting
- Excellent flexlife
- Laser markable

Applications/Markets



- Electrical Insulation
- Protective Cover
- Cable Liner
- Spacer

Certifications/Compliance

- AMS 3653E
- VW1, UL-83 (natural)
- FDA Compliant
- USP Class VI Compliant
- **Light Wall** (TFL) – ASTM D3295 Class 1, AMS 3654C
- **Thin Wall** (TFT) – ASTM D3295 Class 2, AMS 3655B
- **Standard Wall** (TFS) – ASTM D3295 Class 3, MIL-I-22129C

Order Information

Example: TFS1/2-NT

TFS1/2-NT – PTFE

TFS1/2-NT – Standard Wall

TFS1/2-NT – Tube O.D. in inches (1/2")

TFS1/2-NT – Natural

TFS1/2-NT – Bulk Tubing

Notes

- Working Temperature: 500°F (260°C)
- Package quantities are not continuous - Fractional tubing is supplied in random length coils, with a minimum coil length of 15 feet.
- Custom packaging, sizes and lengths are quoted upon request.

Colors

- ○ Natural, Translucent
- Colors available as custom run, see color code table

Fittings

Fittings available for sizes 3/32" up to 1.1"

Parker Fittings available from:
Fluid System Connectors Division
Otsego, MI

(269) 694-2550

(269) 692-6634 FAX





FSC Product Families:

- TrueSeal™

Color Code

○	N	Natural	●	5	Green
●	0	Black	●	6	Blue
●	1	Brown	●	7	Violet
●	2	Red	●	8	Gray
●	3	Orange	○	9	White
●	4	Yellow			

TFS, TFT & TFL PTFE Fractional Tubing

Size			Nominal I.D.		Standard Wall			Thin Wall			Light Wall			Standard Packaging
					Part Number	Nominal Wall		Part Number	Nominal Wall		Part Number	Nominal Wall		
														
inch	inch	mm	Natural	inch	mm	Natural	inch	mm	Natural	inch	mm			
1/8	0.125	3.18	TFS1/8	0.020	0.51	TFT1/8	0.015	0.38	TFL1/8	0.008	0.20	Random Length Coil		
3/16	0.188	4.78	TFS3/16	0.020	0.51	TFT3/16	0.015	0.38	TFL3/16	0.010	0.25	Random Length Coil		
1/4	0.250	6.35	TFS1/4	0.020	0.51	TFT1/4	0.015	0.38	TFL1/4	0.010	0.25	Random Length Coil		
5/16	0.318	7.92	TFS5/16	0.020	0.51	TFT5/16	0.015	0.38	TFL5/16	0.012	0.30	Random Length Coil		
3/8	0.381	9.52	TFS3/8	0.025	0.64	TFT3/8	0.015	0.38	TFL3/8	0.015	0.38	Random Length Coil		
7/16	0.444	11.13	TFS7/16	0.025	0.64	TFT7/16	0.018	0.46	TFL7/16	0.018	0.46	Random Length Coil		
1/2	0.507	12.70	TFS1/2	0.025	0.64	TFT1/2	0.018	0.46	TFL1/2	0.018	0.46	Random Length Coil		
5/8	0.632	15.88	TFS5/8	0.025	0.64	TFT5/8	0.020	0.51	-	-	-	Random Length Coil		
3/4	0.760	19.05	TFS3/4	0.030	0.76	TFT3/4	0.025	0.64	-	-	-	Random Length Coil		
7/8	0.885	22.22	TFS7/8	0.035	0.89	-	-	-	-	-	-	Random Length Coil		
1	1.010	25.40	TFS1.00	0.035	0.89	-	-	-	-	-	-	Random Length Coil		

For detailed ordering information, please consult price list or contact Parflex® Division.



PTFE Tubing

Series AWG: TFH, TFS, TFT, TFL

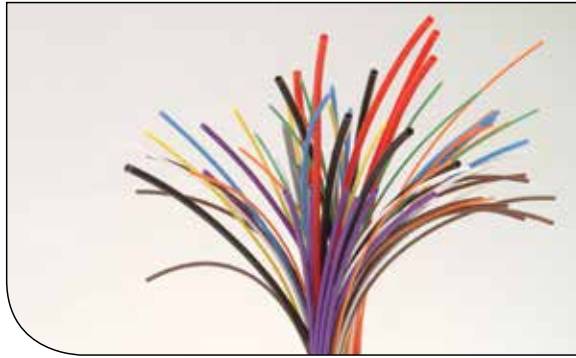

Features

- Virgin Polytetrafluoroethylene resin
- Chemically inert
- Lowest coefficient of friction
- Superior dielectric strength
- Exceptional heat resistance
- Self extinguishing
- Non-wetting
- Excellent flexlife
- Laser markable

Applications/Markets



- Electrical Insulation
- Protective Cover
- Circuit Board
- Wire Insulation
- Strain Relief
- Introducer
- Stent Delivery

Certifications/Compliance

- AMS 3653E
- VW1, UL-83 (natural)
- FDA Compliant
- USP Class VI Compliant
- **Light Wall** (TFL) – ASTM D3295 Class 1, AMS 3654C, UL-224 150V 200°C
- **Thin Wall** (TFT) – ASTM D3295 Class 2, AMS 3655B, UL-224 300V 200°C, CSA 9032-01 300V
- **Standard Wall** (TFS) – ASTM D3295 Class 3, MIL-I-22129C, UL-224 600V 200°C, CSA 9032-01 600V
- **Heavy Wall** (TFH) – ASTM D3295, Class 4

Order Information

Example: TFH13-2TC

TFH13-2TC – PTFE

TFH13-2TC – Heavy Wall

TFH13-2TC – AWG Size

TFH13-2TC – Red

TFH13-2TC – Bulk Tubing

TFH13-2TC – Solid Color Tube

Notes

- Working Temperature: 500°F (260°C)
- AWG Spaghetti tubing is supplied in random lengths with a minimum length of 25 feet
- Continuous lengths and colors quoted upon request
- AWG spaghetti tubing is also available in FEP and PFA
- Consult factory for pricing and minimum lengths

Colors

- ○ Natural, Translucent
- Colors available as custom run, see color code table

Color Code					
○	N	Natural	●	5	Green
●	0	Black	●	6	Blue
●	1	Brown	●	7	Violet
●	2	Red	●	8	Gray
●	3	Orange	○	9	White
●	4	Yellow			

TFH PTFE AWG Heavy Wall

Part Number	Order Size	Nominal I.D.		Minimum I.D.		Maximum I.D.		Nominal Wall		Standard Packaging
		inch	mm	inch	mm	inch	mm	inch	mm	
#										
	AWG	inch	mm	inch	mm	inch	mm	inch	mm	
TFH24	24	0.022	0.56	0.020	0.51	0.026	0.66	0.016 ± 0.003	0.41 ± 0.08	1,000 ft. Spool
TFH23	23	0.026	0.66	0.023	0.58	0.029	0.74	0.016 ± 0.003	0.41 ± 0.08	1,000 ft. Spool
TFH22	22	0.028	0.71	0.025	0.64	0.032	0.81	0.016 ± 0.003	0.41 ± 0.08	1,000 ft. Spool
TFH21	21	0.032	0.81	0.029	0.74	0.035	0.89	0.016 ± 0.003	0.41 ± 0.08	1,000 ft. Spool
TFH20	20	0.034	0.86	0.032	0.81	0.040	1.02	0.018 ± 0.003	0.46 ± 0.08	1,000 ft. Spool
TFH19	19	0.038	0.97	0.036	0.91	0.044	1.12	0.020 ± 0.004	0.51 ± 0.10	1,000 ft. Spool
TFH18	18	0.042	1.07	0.040	1.02	0.049	1.25	0.020 ± 0.004	0.51 ± 0.10	1,000 ft. Spool
TFH17	17	0.048	1.22	0.045	1.14	0.054	1.37	0.020 ± 0.004	0.51 ± 0.10	1,000 ft. Spool
TFH16	16	0.053	1.35	0.051	1.30	0.061	1.55	0.020 ± 0.004	0.51 ± 0.10	1,000 ft. Spool
TFH15	15	0.059	1.50	0.057	1.45	0.067	1.70	0.020 ± 0.004	0.51 ± 0.10	1,000 ft. Spool
TFH14	14	0.066	1.68	0.064	1.63	0.074	1.88	0.020 ± 0.004	0.51 ± 0.10	500 ft. Spool
TFH13	13	0.076	1.93	0.072	1.83	0.082	2.08	0.020 ± 0.004	0.51 ± 0.10	500 ft. Spool
TFH12	12	0.085	2.16	0.081	2.06	0.091	2.31	0.020 ± 0.004	0.51 ± 0.10	500 ft. Spool
TFH11	11	0.095	2.41	0.091	2.31	0.101	2.57	0.020 ± 0.004	0.51 ± 0.10	500 ft. Spool
TFH10	10	0.106	2.69	0.102	2.59	0.112	2.84	0.025 ± 0.005	0.64 ± 0.13	500 ft. Spool
TFH09	9	0.118	3.00	0.114	2.90	0.124	3.15	0.025 ± 0.005	0.64 ± 0.13	500 ft. Spool
TFH08	8	0.133	3.38	0.129	3.28	0.141	3.58	0.030 ± 0.005	0.76 ± 0.13	Random Length Coil
TFH07	7	0.148	3.76	0.144	3.66	0.158	4.01	0.030 ± 0.005	0.76 ± 0.13	Random Length Coil
TFH06	6	0.166	4.22	0.162	4.11	0.178	4.52	0.030 ± 0.005	0.76 ± 0.13	Random Length Coil
TFH05	5	0.185	4.70	0.182	4.62	0.196	4.98	0.032 ± 0.005	0.81 ± 0.13	Random Length Coil

Certifications

- ASTM D3295 Class 4
- AMS 3653E
- FDA Compliant
- USP Class VI Compliant

For detailed ordering information, please consult price list or contact Parflex® Division.

Parker Hannifin Corporation | Parflex® Division | Ravenna, Ohio | parker.com/pfd

www.comoso.com



PTFE Tubing

Series AWG: TFH, TFL, TFS, TFT (cont.)

TFS PTFE AWG Standard Wall

Part Number	Order Size	Nominal I.D.		Minimum I.D.		Maximum I.D.		Nominal Wall		Standard Packaging
#										
	AWG	inch	mm	inch	mm	inch	mm	inch	mm	
TFS30	30	0.012	0.31	0.010	0.25	0.015	0.38	.009 ± .002	0.23 ± 0.51	1,000 ft. Spool
TFS28	28	0.015	0.38	0.013	0.33	0.018	0.46	.009 ± .002	0.23 ± 0.51	1,000 ft. Spool
TFS26	26	0.018	0.46	0.016	0.41	0.022	0.56	.009 ± .002	0.23 ± 0.51	1,000 ft. Spool
TFS24	24	0.022	0.56	0.020	0.51	0.026	0.66	.012 ± .003	0.31 ± 0.08	1,000 ft. Spool
TFS23	23	0.026	0.66	0.023	0.58	0.029	0.74	.012 ± .003	0.31 ± 0.08	1,000 ft. Spool
TFS22	22	0.028	0.71	0.025	0.64	0.032	0.81	.012 ± .003	0.31 ± 0.08	1,000 ft. Spool
TFS21	21	0.032	0.81	0.029	0.74	0.035	0.89	.012 ± .003	0.31 ± 0.08	1,000 ft. Spool
TFS20	20	0.034	0.86	0.032	0.81	0.040	1.02	.016 ± .003	0.41 ± .008	1,000 ft. Spool
TFS19	19	0.038	0.97	0.036	0.91	0.044	1.12	.016 ± .003	0.41 ± .008	1,000 ft. Spool
TFS18	18	0.042	1.07	0.040	1.02	0.049	1.25	.016 ± .003	0.41 ± .008	1,000 ft. Spool
TFS17	17	0.048	1.22	0.045	1.14	0.054	1.37	.016 ± .003	0.41 ± .008	1,000 ft. Spool
TFS16	16	0.053	1.35	0.051	1.30	0.061	1.55	.016 ± .003	0.41 ± .008	1,000 ft. Spool
TFS15	15	0.059	1.50	0.057	1.45	0.067	1.70	.016 ± .003	0.41 ± .008	500 ft. Spool
TFS14	14	0.066	1.68	0.064	1.63	0.074	1.88	.016 ± .003	0.41 ± .008	500 ft. Spool
TFS13	13	0.076	1.93	0.072	1.83	0.082	2.08	.016 ± .003	0.41 ± .008	500 ft. Spool
TFS12	12	0.085	2.16	0.081	2.06	0.091	2.31	.016 ± .003	0.41 ± .008	500 ft. Spool
TFS11	11	0.095	2.41	0.091	2.31	0.101	2.57	.016 ± .003	0.41 ± .008	500 ft. Spool
TFS10	10	0.106	2.69	0.102	2.59	0.112	2.84	.016 ± .003	0.41 ± .008	500 ft. Spool
TFS09	9	0.118	3.00	0.114	2.90	0.124	3.15	.020 ± .004	0.51 ± .010	Random Length Coil
TFS08	8	0.133	3.38	0.129	3.28	0.141	3.58	.020 ± .004	0.51 ± .010	Random Length Coil
TFS07	7	0.148	3.76	0.144	3.66	0.158	4.01	.020 ± .004	0.51 ± .010	Random Length Coil
TFS06	6	0.166	4.22	0.162	4.11	0.178	4.52	.020 ± .004	0.51 ± .010	Random Length Coil
TFS05	5	0.185	4.70	0.182	4.62	0.196	4.98	.020 ± .004	0.51 ± .010	Random Length Coil
TFS04	4	0.208	5.28	0.204	5.18	0.224	5.69	.020 ± .004	0.51 ± .010	Random Length Coil
TFS03	3	0.234	5.94	0.229	5.82	0.249	6.32	.020 ± .004	0.51 ± .010	Random Length Coil
TFS02	2	0.263	6.68	0.258	6.55	0.278	7.06	.020 ± .004	0.51 ± .010	Random Length Coil
TFS01	1	0.294	7.47	0.289	7.34	0.311	7.90	.020 ± .004	0.51 ± .010	Random Length Coil
TFS00	0	0.330	8.38	0.325	8.25	0.347	8.81	.020 ± .004	0.51 ± .010	Random Length Coil

Certifications

- ASTM D3295 Class 3
- MIL-I-22129C
- AMS 3653E
- UL-224 600V 200°C
- CSA 9032-01 600V
- FDA Compliant



For detailed ordering information, please consult price list or contact Parflex® Division.

Parker Hannifin Corporation | Parflex® Division | Ravenna, Ohio | parker.com/pfd

www.comoso.com

TFT PTFE AWG Thin Wall

Part Number	Order Size	Nominal I.D.		Minimum I.D.		Maximum I.D.		Nominal Wall		Standard Packaging
		inch	mm	inch	mm	inch	mm	inch	mm	
#										
	AWG	inch	mm	inch	mm	inch	mm	inch	mm	
TFT32	32	.010	0.25	.008	0.20	.012	0.31	0.007 ± 0.002	0.18 ± 0.05	1,000 ft. Spool Only
TFT30	30	.012	0.31	.010	0.25	.015	0.38	0.009 ± 0.002	0.23 ± 0.05	1,000 ft. Spool
TFT28	28	.015	0.38	.013	0.33	.018	0.46	0.009 ± 0.002	0.23 ± 0.05	1,000 ft. Spool
TFT26	26	.018	0.46	.016	0.41	.022	0.56	0.009 ± 0.002	0.23 ± 0.05	1,000 ft. Spool
TFT24	24	.022	0.56	.020	0.51	.026	0.66	0.010 ± 0.003	0.25 ± 0.08	1,000 ft. Spool
TFT23	23	.026	0.66	.023	0.58	.029	0.74	0.010 ± 0.003	0.25 ± 0.08	1,000 ft. Spool
TFT22	22	.028	0.71	.025	0.64	.032	0.81	0.010 ± 0.003	0.25 ± 0.08	1,000 ft. Spool
TFT21	21	.032	0.81	.029	0.74	.035	0.89	0.010 ± 0.003	0.25 ± 0.08	1,000 ft. Spool
TFT20	20	.034	0.86	.032	0.81	.040	1.02	0.012 ± 0.003	0.31 ± 0.08	1,000 ft. Spool
TFT19	19	.038	0.97	.036	0.91	.044	1.12	0.012 ± 0.003	0.31 ± 0.08	1,000 ft. Spool
TFT18	18	.042	1.07	.040	1.02	.049	1.25	0.012 ± 0.003	0.31 ± 0.08	1,000 ft. Spool
TFT17	17	.048	1.22	.045	1.14	.054	1.37	0.012 ± 0.003	0.31 ± 0.08	1,000 ft. Spool
TFT16	16	.053	1.35	.051	1.30	.061	1.55	0.012 ± 0.003	0.31 ± 0.08	1,000 ft. Spool
TFT15	15	.059	1.50	.057	1.45	.067	1.70	0.012 ± 0.003	0.31 ± 0.08	1,000 ft. Spool
TFT14	14	.066	1.68	.064	1.63	.074	1.88	0.012 ± 0.003	0.31 ± 0.08	500 ft. Spool
TFT13	13	.076	1.93	.072	1.83	.082	2.08	0.012 ± 0.003	0.31 ± 0.08	500 ft. Spool
TFT12	12	.085	2.16	.081	2.06	.091	2.31	0.012 ± 0.003	0.31 ± 0.08	500 ft. Spool
TFT11	11	.095	2.41	.091	2.31	.101	2.57	0.012 ± 0.003	0.31 ± 0.08	500 ft. Spool
TFT10	10	.106	2.69	.102	2.59	.112	2.84	0.012 ± 0.003	0.31 ± 0.08	500 ft. Spool
TFT09	9	.118	3.00	.114	2.90	.124	3.15	0.015 ± 0.003	0.38 ± 0.08	500 ft. Spool
TFT08	8	.133	3.38	.129	3.28	.141	3.58	0.015 ± 0.003	0.38 ± 0.08	Random Length Coil
TFT07	7	.148	3.76	.144	3.66	.158	4.01	0.015 ± 0.003	0.38 ± 0.08	Random Length Coil
TFT06	6	.166	4.22	.162	4.11	.178	4.52	0.015 ± 0.003	0.38 ± 0.08	Random Length Coil
TFT05	5	.185	4.70	.182	4.62	.196	4.98	0.015 ± 0.003	0.38 ± 0.08	Random Length Coil
TFT04	4	.208	5.28	.204	5.18	.224	5.69	0.015 ± 0.003	0.38 ± 0.08	Random Length Coil
TFT03	3	.234	5.94	.229	5.82	.249	6.32	0.015 ± 0.003	0.38 ± 0.08	Random Length Coil
TFT02	2	.263	6.68	.258	6.55	.278	7.06	0.015 ± 0.003	0.38 ± 0.08	Random Length Coil
TFT01	1	.294	7.47	.289	7.34	.311	7.90	0.015 ± 0.003	0.38 ± 0.08	Random Length Coil
TFT00	0	.330	8.38	.325	8.25	.347	8.81	0.015 ± 0.003	0.38 ± 0.08	Random Length Coil

Certifications

- ASTM D3295 Class 2
- AMS 3653E
- AMS 3655B
- UL-224 300V 200°C
- CSA 9032-01 300V
- FDA Compliant
- USP Class VI Compliant

For detailed ordering information, please consult price list or contact Parflex® Division.

Parker Hannifin Corporation | Parflex® Division | Ravenna, Ohio | parker.com/pfd

www.comoso.com



PTFE Tubing

Series AWG: TFH, TFL, TFS, TFT (cont.)

TFL PTFE AWG Light Wall

Part Number	Order Size	Nominal I.D.		Minimum I.D.		Maximum I.D.		Nominal Wall		Standard Packaging
		inch	mm	inch	mm	inch	mm	inch	mm	
#										
	AWG	inch	mm	inch	mm	inch	mm	inch	mm	
TFL32	32	0.010	0.25	0.008	0.20	0.012	0.31	0.005 ± 0.002	0.13 ± 0.05	1,000 ft. Spool Only
TFL30	30	0.012	0.31	0.010	0.25	0.015	0.38	0.006 ± 0.002	0.13 ± 0.05	1,000 ft. Spool
TFL28	28	0.015	0.38	0.013	0.33	0.018	0.46	0.006 ± 0.002	0.13 ± 0.05	1,000 ft. Spool
TFL26	26	0.018	0.46	0.016	0.41	0.022	0.56	0.006 ± 0.002	0.13 ± 0.05	1,000 ft. Spool
TFL24	24	0.022	0.56	0.020	0.51	0.026	0.66	0.006 ± 0.002	0.13 ± 0.05	1,000 ft. Spool
TFL23	23	0.026	0.66	0.023	0.58	0.029	0.74	0.006 ± 0.002	0.13 ± 0.05	1,000 ft. Spool
TFL22	22	0.028	0.71	0.025	0.64	0.032	0.81	0.006 ± 0.002	0.13 ± 0.05	1,000 ft. Spool
TFL21	21	0.032	0.81	0.029	0.74	0.035	0.89	0.006 ± 0.002	0.13 ± 0.05	1,000 ft. Spool
TFL20	20	0.034	0.86	0.032	0.81	0.040	1.02	0.006 ± 0.002	0.13 ± 0.05	1,000 ft. Spool
TFL19	19	0.038	0.97	0.036	0.91	0.044	1.12	0.006 ± 0.002	0.13 ± 0.05	1,000 ft. Spool
TFL18	18	0.042	1.07	0.040	1.02	0.049	1.25	0.006 ± 0.002	0.13 ± 0.05	1,000 ft. Spool
TFL17	17	0.048	1.22	0.045	1.14	0.054	1.37	0.006 ± 0.002	0.13 ± 0.05	1,000 ft. Spool
TFL16	16	0.053	1.35	0.051	1.30	0.061	1.55	0.006 ± 0.002	0.13 ± 0.05	1,000 ft. Spool
TFL15	15	0.059	1.50	0.057	1.45	0.067	1.70	0.006 ± 0.002	0.13 ± 0.05	1,000 ft. Spool
TFL14	14	0.066	1.68	0.064	1.63	0.074	1.88	0.008 ± 0.002	0.20 ± 0.05	500 ft. Spool
TFL13	13	0.076	1.93	0.072	1.83	0.082	2.08	0.008 ± 0.002	0.20 ± 0.05	500 ft. Spool
TFL12	12	0.085	2.16	0.081	2.06	0.091	2.31	0.008 ± 0.002	0.20 ± 0.05	500 ft. Spool
TFL11	11	0.095	2.41	0.091	2.31	0.101	2.57	0.008 ± 0.002	0.20 ± 0.05	500 ft. Spool
TFL10	10	0.106	2.69	0.102	2.59	0.112	2.84	0.008 ± 0.002	0.20 ± 0.05	500 ft. Spool
TFL09	9	0.118	3.00	0.114	2.90	0.124	3.15	0.008 ± 0.002	0.20 ± 0.05	500 ft. Spool
TFL08	8	0.133	3.38	0.129	3.28	0.141	3.58	0.008 ± 0.002	0.20 ± 0.05	Random Length Coil
TFL07	7	0.148	3.76	0.144	3.66	0.158	4.01	0.008 ± 0.002	0.20 ± 0.05	Random Length Coil
TFL06	6	0.166	4.22	0.162	4.11	0.178	4.52	0.010 ± 0.003	0.25 ± 0.08	Random Length Coil
TFL05	5	0.185	4.70	0.182	4.62	0.196	4.98	0.010 ± 0.003	0.25 ± 0.08	Random Length Coil
TFL04	4	0.208	5.28	0.204	5.18	0.224	5.69	0.010 ± 0.003	0.25 ± 0.08	Random Length Coil
TFL03	3	0.234	5.94	0.229	5.82	0.249	6.32	0.010 ± 0.003	0.25 ± 0.08	Random Length Coil
TFL02	2	0.263	6.68	0.258	6.55	0.278	7.06	0.010 ± 0.003	0.25 ± 0.08	Random Length Coil
TFL01	1	0.294	7.47	0.289	7.34	0.311	7.90	0.012 ± 0.003	0.31 ± 0.08	Random Length Coil
TFL00	0	0.330	8.38	0.325	8.25	0.347	8.81	0.012 ± 0.003	0.31 ± 0.08	Random Length Coil

Certifications

- ASTM D3295 Class 1
- AMS 3653E
- AMS 3654C
- UL-224 150V 200°C
- FDA Compliant
- USP Class VI Compliant



For detailed ordering information, please consult price list or contact Parflex® Division.

Parker Hannifin Corporation | Parflex® Division | Ravenna, Ohio | parker.com/pfd

www.comoso.com

PTFE Beading

Series Fractional: TFB

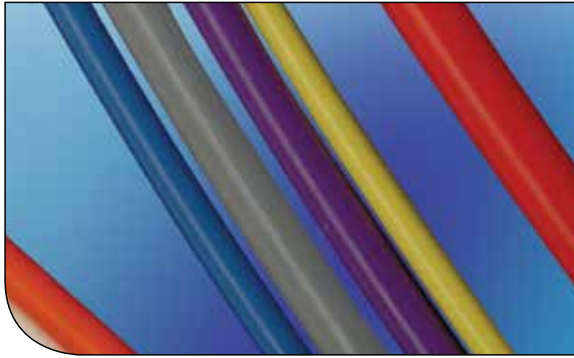

Applications/Markets



- Pull Cord
- O-ring Seals
- Spacers
- Woven Filter

TFB PTFE Beading

Part Number	Diameter		Tolerance		Standard Packaging
	inch	mm	inch	mm	
#	⊙				
TFB015	0.015	0.38	± 0.002	± 0.05	1,000 ft. Spool
TFB020	0.020	0.51	± 0.002	± 0.05	1,000 ft. Spool
TFB025	0.025	0.64	± 0.002	± 0.05	1,000 ft. Spool
TFB028	0.028	0.71	± 0.002	± 0.05	1,000 ft. Spool
TFB031	0.031	0.79	± 0.002	± 0.05	1,000 ft. Spool
TFB035	0.035	0.89	± 0.002	± 0.05	1,000 ft. Spool
TFB039	0.039	0.99	± 0.002	± 0.05	1,000 ft. Spool
TFB043	0.043	1.09	± 0.002	± 0.05	1,000 ft. Spool
TFB047	0.047	1.19	± 0.002	± 0.05	1,000 ft. Spool
TFB050	0.050	1.27	± 0.002	± 0.05	1,000 ft. Spool
TFB055	0.055	1.40	± 0.003	± 0.08	1,000 ft. Spool
TFB060	0.060	1.52	± 0.003	± 0.08	1,000 ft. Spool
TFB062	0.062	1.57	± 0.003	± 0.08	1,000 ft. Spool
TFB070	0.070	1.78	± 0.003	± 0.08	1,000 ft. Spool
TFB072	0.072	1.83	± 0.003	± 0.08	1,000 ft. Spool
TFB078	0.078	1.98	± 0.004	± 0.10	500 ft. Spool
TFB080	0.080	2.03	± 0.004	± 0.10	500 ft. Spool
TFB084	0.084	2.13	± 0.004	± 0.10	500 ft. Spool
TFB090	0.090	2.29	± 0.004	± 0.10	500 ft. Spool
TFB094	0.094	2.39	± 0.004	± 0.10	500 ft. Spool
TFB100	0.100	2.54	± 0.004	± 0.10	500 ft. Spool
TFB109	0.109	2.77	± 0.004	± 0.10	500 ft. Spool
TFB115	0.115	2.92	± 0.004	± 0.10	500 ft. Spool
TFB125	0.125	3.18	± 0.004	± 0.10	Random Length
TFB150	0.150	3.81	± 0.004	± 0.10	Random Length
TFB188	0.188	4.78	± 0.004	± 0.10	Random Length

Features

- Virgin Polytetrafluoroethylene resin
- Chemically inert
- Lowest coefficient of friction
- Superior dielectric strength
- Exceptional heat resistance
- Self extinguishing
- Non-wetting
- Excellent flexlife
- Laser markable

Certifications

- ASTM D1710, Type 1, Grade 1, Class B
- ASTM D3295
- VW1, UL-83 (natural)
- FDA Compliant
- USP Class VI Compliant

Notes

- Working Temperature: -100°F to 500°F (-75°C to 260°C)
- Package quantities are not continuous

Colors

- ○ Natural, Translucent
- Colors available as custom run, see color code table

Color Code					
○	N	Natural	●	5	Green
●	0	Black	●	6	Blue
●	1	Brown	●	7	Violet
●	2	Red	●	8	Gray
●	3	Orange	○	9	White
●	4	Yellow			

Order Information

Example: TFB028-NT

TFB028-NT – PTFE Beading

TFB028-NT – Beading O.D. in inches (.028")

TFB028-NT – Natural

TFB028-NT – Bulk Tubing

For detailed ordering information, please consult price list or contact Parflex® Division.

Parker Hannifin Corporation | Parflex® Division | Ravenna, Ohio | parker.com/pfd

www.comoso.com



B-65

PTFE Spiral Cut Cable Wrap

Series: TSWTF

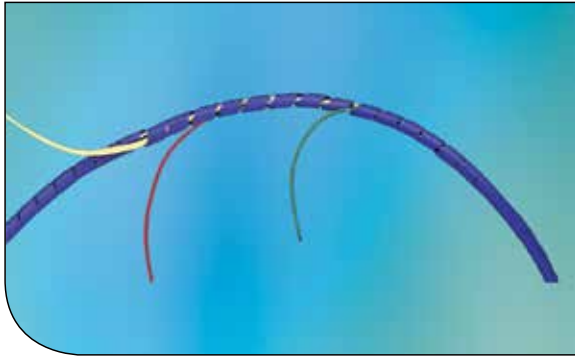

Applications/Markets



- Cable harnessing
- Wiring closets
- Aerospace
- Automotive

Order Information

Example: TSWTF-3/8-5T

TSWTF-3/8-5T – Spiral Wrap

TSWTF-3/8-5T – Material (PTFE)

TSWTF-3/8-5T – O.D. in inches (.375")

TSWTF-3/8-5T – Green

TSWTF-3/8-5T – Bulk Tubing

Features

- Provides harnessing for wires and cable while allowing leads at various points
- Exceptional heat resistance
- Self extinguishing
- Flexible
- Superior dielectric strength

Certifications

- A-A-59602
- AMS 3653E
- ASTM D3295
- VW1, UL-83 (natural)

Notes

- Available in left- or right-hand cut. Please specify with proper suffix at end of part number (i.e. TSWTF-18-NT-R)
- Working Temperature: 500°F (260°C)
- 100 ft. is the minimum item quantity sold
- Stock packaging for sizes 1/8" to 1/2" is 100- and 500-ft. non-continuous spools and, for sizes greater than 1/2", 100-ft. non-continuous spools
- Custom packaging, sizes and colors are available upon request
- Spiral cut cable wrap is also quoted in FEP upon request
- Package quantities are not continuous
- Colors available as custom run, see color code table

Colors

- ○ Natural, Translucent
- Colors available as custom run, see color code table

Color Code						
○	N	Natural	●	5	Green	
●	0	Black	●	6	Blue	
●	1	Brown	●	7	Violet	
●	2	Red	●	8	Gray	
●	3	Orange	○	9	White	
●	4	Yellow				

PTFE Spiral Wrap

Part Number	O.D. "A"		tolerance O.D.		Wall "B"		tolerance Wall		Pitch "D"		tolerance Pitch		Max Bundle O.D. "C"	
	inch	mm	inch	mm	inch	mm	inch	mm	inch	mm	inch	mm	inch	mm
#														
TSWTF-1/8-NT	0.125	3.18	± 0.005	0.127	0.020	0.508	± 0.008	0.203	0.212	5.38	± 0.015	0.381	1/2	12.70
TSWTF-3/16-NT	0.188	4.78	± 0.005	0.127	0.030	0.762	± 0.008	0.203	0.312	7.92	± 0.015	0.381	1	25.40
TSWTF-1/4-NT	0.250	6.35	± 0.005	0.127	0.030	0.762	± 0.008	0.203	0.375	9.52	± 0.015	0.381	2	50.80
TSWTF-3/8-NT	0.375	9.52	± 0.005	0.127	0.030	0.762	± 0.008	0.203	0.437	11.10	± 0.015	0.381	2-1/2	63.50
TSWTF-1/2-NT	0.500	12.70	± 0.005	0.127	0.030	0.762	± 0.008	0.203	0.562	14.27	± 0.015	0.381	3	76.20
TSWTF-3/4-NT	0.750	19.05	± 0.005	0.127	0.040	1.02	± 0.008	0.203	0.875	22.22	± 0.015	0.381	4	101.60
TSWTF-1.00-NT	1	25.40	± 0.005	0.127	0.040	1.02	± 0.008	0.203	1	25.40	± 0.015	0.381	6	152.40

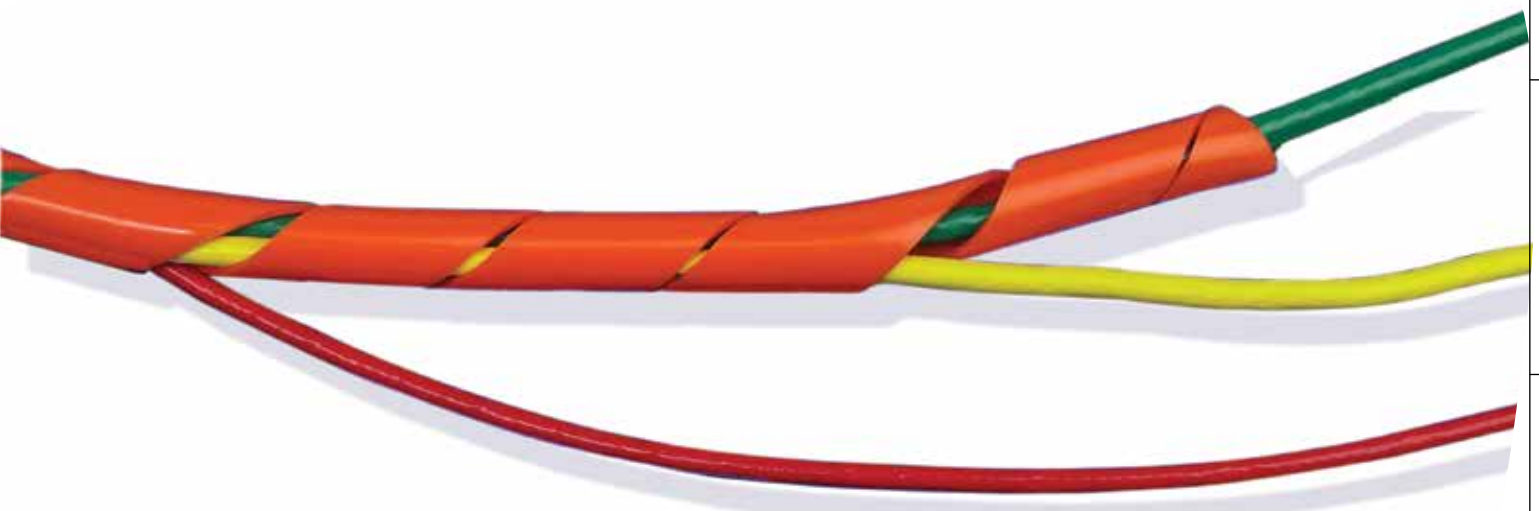
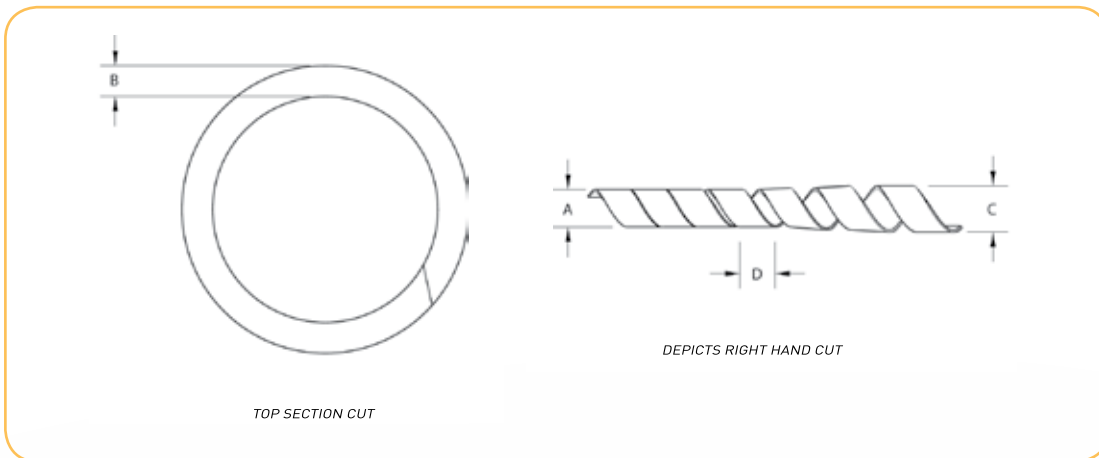

For detailed ordering information, please consult price list or contact Parflex® Division.

Parker Hannifin Corporation | Parflex® Division | Ravenna, Ohio | parker.com/pfd

www.comoso.com



B-67

A Hose

B Tubing
Fluoropolymer

C Coiled Air Hose
& Fittings

D Transportation

E Fittings

F Tooling, Equipment
& Accessories

G General Technical

PTFE Heat Shrinkable Tubing

Series 2:1 Fractional: HS2TFS, HS2TFT, HS2TFL, HS2TFI



Features

- Virgin Polytetrafluoroethylene resin
- 2:1 Shrink Ratio
- Chemically inert
- Lowest coefficient of friction
- Superior dielectric strength
- Exceptional heat resistance
- Self extinguishing
- Non-wetting

Certifications

- ASTM D2902 Type I
- AMS 3653E
- VW1, UL-83 (natural)
- FDA Compliant
- USP Class VI Compliant
- **Light Wall** (HS2TFL) - AMS-DTL-23053/12A Class 4
- **Thin Wall** (HS2TFT) - AMS-DTL-23053/12A Class 3, AMS 3585
- **Standard Wall** (HS2TFS) - AMS-DTL-23053/12A Class 2, AMS 3586
- **Heavy Wall** (HS2TFH) - AMS-DTL-23053/12A Class 1 (Custom Order only)

Applications/Markets



- Electrical Insulation
- Protective Cover
- Electronic Harness
- Laboratory

Order Information

Example: HS2TFI7/8-NT

HS2TFI7/8-NT – Heat Shrink

HS2TFI7/8-NT – Shrink Ratio (2:1)

HS2TFI7/8-NT – PTFE

HS2TFI7/8-NT – Wall Type (Industrial Wall)

HS2TFI7/8-NT – Heat Shrink Size in inches (7/8")

HS2TFI7/8-NT – Natural

HS2TFI7/8-NT – Bulk Tubing

Notes

- Working Temperature: -100°F to 500°F (-75°C to 260°C)
- Shrink Temperature: 662°F (350°C) for 10 minutes per AMS-DTL-23053/12A
- *Dielectric Strength: $\geq 1,400$ V/M, per ASTM D 149 short term test of 10 MIL thickness (Volts/MIL)
- PTFE Fractional Heat Shrink tubing is available in stock packaging of 4-ft. straight lengths
- Minimum quantities may apply
- Custom packaging, sizes, lengths and colors are quoted upon request

Colors

- ○ Natural, Opaque to translucent
- Colors available as custom run, see color code table

When ordering coiled tubing in colors, the color code is always followed by TC; when ordering cut lengths, the color code is followed by CC

ie HS2TFI7/8-2TC ie HS2TFI7/8-0CC48.000

Color Code					
○	N	Natural	●	5	Green
●	0	Black	●	6	Blue
●	1	Brown	●	7	Violet
●	2	Red	●	8	Gray
●	3	Orange	○	9	White
●	4	Yellow			

HS2TFS & HS2TFT PTFE Fractional Heat Shrink Tubing (2:1) SW & TW

Order Size	Minimum Expanded I.D.		Maximum Recovered I.D.		Standard Wall				Thin Wall			
					Mil Spec*	Part Number	Nominal Recovered Wall		Mil Spec*	Part Number	Nominal Recovered Wall	
	inch	mm	inch	mm			inch	mm				
1/8	0.215	05.5	0.130	3.3	23053/12A-215	HS2TFS1/8	0.020 ± 0.004	0.51 ± 0.10	23053/12A-319	HS2TFT1/8	0.015 ± 0.003	0.38 ± 0.08
1/4	0.410	10.4	0.260	6.6	23053/12A-222	HS2TFS1/4	0.020 ± 0.004	0.51 ± 0.10	23053/12A-326	HS2TFT1/4	0.015 ± 0.004	0.38 ± 0.10
5/16	0.470	11.9	0.329	8.4	23053/12A-225	HS2TFS5/16	0.020 ± 0.004	0.51 ± 0.10	23053/12A-329	HS2TFT5/16	0.015 ± 0.004	0.38 ± 0.10
3/8	0.560	14.2	0.399	10.1	23053/12A-228	HS2TFS3/8	0.025 ± 0.006	0.64 ± 0.15	-	HS2TF 3/8	0.015 ± 0.004	0.38 ± 0.10
7/16	0.655	16.6	0.462	11.7	23053/12A-229	HS2TFS7/16	0.025 ± 0.006	0.64 ± 0.15	-	HS2TFT7/16	0.018 ± 0.004	0.46 ± 0.10
1/2	0.750	19.1	0.524	13.3	23053/12A-230	HS2TFS1/2	0.025 ± 0.006	0.64 ± 0.15	-	HS2TFT1/2	0.018 ± 0.004	0.46 ± 0.10
5/8	0.930	23.6	0.655	16.6	23053/12A-231	HS2TFS5/8	0.030 ± 0.006	0.76 ± 0.15	-	HS2TF 5/8	0.020 ± 0.004	0.51 ± 0.10
3/4	1.125	28.6	0.786	20.0	23053/12A-232	HS2TFS3/4	0.035 ± 0.008	0.89 ± 0.20	-	HS2TFT3/4	0.025 ± 0.004	0.64 ± 0.10
7/8	1.130	28.7	0.911	23.1	23053/12A-233	HS2TFS7/8	0.035 ± 0.008	0.89 ± 0.20	-	HS2TFT7/8	0.025 ± 0.004	0.64 ± 0.10
1	1.500	38.1	1.036	26.3	23053/12A-234	HS2TFS1.00	0.035 ± 0.008	0.89 ± 0.20	-	HS2TFT1.00	0.025 ± 0.004	0.64 ± 0.10

HS2TFL PTFE Fractional Heat Shrink Tubing (2:1) LW

Order Size	Minimum Expanded I.D.		Maximum Recovered I.D.		Light Wall			
					Mil Spec*	Part Number	Nominal Recovered Wall	
	inch	mm	inch	mm				
1/8	0.215	5.5	0.130	3.3	23053/12A-415	HS2TFL1/8	0.008 ± 0.002	0.20 ± 0.05
1/4	0.410	10.4	0.260	6.6	23053/12A-422	HS2TFL1/4	0.010 ± 0.003	0.25 ± 0.08
5/16	0.470	11.9	0.329	8.4	23053/12A-425	HS2TFL5/16	0.012 ± 0.003	0.31 ± 0.08

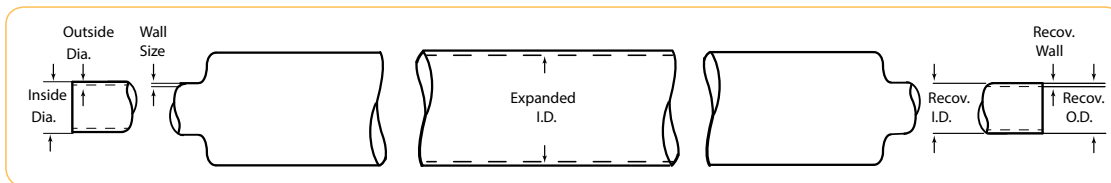

HS2TFI PTFE Fractional Heat Shrink Tubing (2:1), Ind. Heavy Wall

Part Number	Order Size	Mil Spec*	Minimum Expanded I.D.		Maximum Recovered I.D.		Nominal Recovered Wall	
			inch	mm	inch	mm	inch	mm
HS2TFI1/8	1/8	23053/12A-101	0.166	4.2	0.130	3.3	0.030 ± 0.005	0.76 ± 0.13
HS2TFI3/16	3/16	23053/12A-102	0.250	6.4	0.193	4.9	0.030 ± 0.005	0.76 ± 0.13
HS2TFI1/4	1/4	23053/12A-103	0.333	8.4	0.257	6.5	0.030 ± 0.005	0.76 ± 0.13
HS2TFI5/16	5/16	23053/12A-104	0.415	10.5	0.320	8.1	0.030 ± 0.005	0.76 ± 0.13
HS2TFI3/8	3/8	23053/12A-105	0.498	12.6	0.383	9.7	0.030 ± 0.005	0.76 ± 0.13
HS2TFI7/16	7/16	23053/12A-106	0.580	14.7	0.448	11.4	0.030 ± 0.006	0.76 ± 0.15
HS2TFI1/2	1/2	23053/12A-107	0.666	16.9	0.510	13.0	0.030 ± 0.006	0.76 ± 0.15
HS2TFI9/16	9/16	23053/12A-108	0.748	19.0	0.572	14.5	0.030 ± 0.006	0.76 ± 0.15
HS2TFI5/8	5/8	23053/12A-109	0.830	21.1	0.637	16.2	0.030 ± 0.006	0.76 ± 0.15
HS2TFI11/16	11/16	23053/12A-110	0.915	23.2	0.700	17.8	0.032 ± 0.006	0.81 ± 0.15
HS2TFI3/4	3/4	23053/12A-111	1.000	25.4	0.764	19.4	0.040 ± 0.007	1.02 ± 0.18
HS2TFI7/8	7/8	23053/12A-112	1.170	29.7	0.891	22.6	0.045 ± 0.007	1.14 ± 0.18
HS2TFI1.00	1	23053/12A-113	1.330	33.8	1.020	25.9	0.050 ± 0.008	1.27 ± 0.20

For detailed ordering information, please consult price list or contact Parflex® Division.



PTFE Heat Shrinkable Tubing

Series 2:1 AWG: HS2TFS, HS2TFT, HS2TFL



Applications/Markets



- Electrical Insulation
- Protective Cover
- Electronic Harness
- Laboratory

Features

- Virgin Polytetrafluoroethylene resin
- 2:1 Shrink Ratio
- Chemically inert
- Lowest coefficient of friction
- Superior dielectric strength
- Exceptional heat resistance
- Self extinguishing
- Non-wetting

Certifications

- ASTM D2902 Type I
- AMS 3653E
- VW1, UL-83 (natural)
- FDA Compliant
- USP Class VI Compliant
- **Light Wall** (HS2TFL) – AMS-DTL-23053/12A Class 4
- **Thin Wall** (HS2TFT) – AMS-DTL-23053/12A Class 3, AMS 3585
- **Standard Wall** (HS2TFS) – AMS-DTL-23053/12A Class 2, AMS 3586
- **Heavy Wall** (HS2TFH) – AMS-DTL-23053/12A Class 1 (Custom Order only)

Order Information

Example: HS2TFS15-4TC-500

HS2TFS15-4TC-500 – Heat Shrink

HS2TFS15-4TC-500 – Shrink Ratio (2:1)

HS2TFS15-4TC-500 – PTFE

HS2TFS15-4TC-500 – Wall Type (Standard Wall)

HS2TFS15-4TC-500 – Heat Shrink Size in AWG (AWG15)

HS2TFS15-4TC-500 – Yellow

HS2TFS15-4TC-500 – Bulk Tubing

HS2TFS15-4TC-500 – Solid Color

HS2TFS15-4TC-500 – Package Quantity in feet (500')

Notes

- Working Temperature: -100°F to 500°F (-75°C to 260°C)
- Shrink Temperature: 662°F (350°C) for 10 minutes AMS-DTL-23053/12A
- *Dielectric Strength: $\geq 1,400$ V/M, per ASTM D 149 short term test of 10 MIL thickness (Volts/MIL)
- PTFE AWG Heat Shrink tubing is available in stock packaging of 4-ft. straight lengths
- Minimum quantities may apply
- Custom packaging, sizes, lengths and colors are quoted upon request

Colors

- ○ Natural, Opaque to translucent
- Colors available as custom run, see color code table

When ordering coiled tubing in colors, the color code is always followed by TC; when ordering cut lengths, the color code is followed by CC

ie HS2TFS15-2TC

ie HS2TFS15-0CC48.000

Color Code					
○	N	Natural	●	5	Green
●	0	Black	●	6	Blue
●	1	Brown	●	7	Violet
●	2	Red	●	8	Gray
●	3	Orange	○	9	White
●	4	Yellow			

HS2TFS Standard Wall (2:1)

Part Number	Order Size AWG	Mil Spec*	Minimum Expanded I.D.		Maximum Recovered I.D.		Nominal Recovered Wall	
			inch	mm	inch	mm	inch	mm
HS2TFS24	24	23053/12A-201	0.050	1.27	0.027	0.69	0.012 ± 0.002	0.31 ± 0.05
HS2TFS22	22	23053/12A-202	0.055	1.40	0.032	0.81	0.012 ± 0.002	0.31 ± 0.05
HS2TFS20	20	23053/12A-203	0.060	1.52	0.039	0.99	0.016 ± 0.003	0.41 ± 0.08
HS2TFS19	19	23053/12A-204	0.065	1.65	0.043	1.09	0.016 ± 0.003	0.41 ± 0.08
HS2TFS18	18	23053/12A-205	0.076	1.93	0.049	1.25	0.016 ± 0.003	0.41 ± 0.08
HS2TFS17	17	23053/12A-206	0.085	2.16	0.054	1.37	0.016 ± 0.003	0.41 ± 0.08
HS2TFS16	16	-	0.093	2.36	0.061	1.55	0.016 ± 0.003	0.41 ± 0.08
HS2TFS15	15	23053/12A-207	0.110	2.79	0.067	1.70	0.016 ± 0.003	0.41 ± 0.08
HS2TFS14	14	23053/12A-208	0.120	3.05	0.072	1.83	0.016 ± 0.003	0.41 ± 0.08
HS2TFS13	13	23053/12A-210	0.140	3.56	0.080	2.03	0.016 ± 0.003	0.41 ± 0.08
HS2TFS12	12	23053/12A-211	0.150	3.81	0.089	2.26	0.016 ± 0.003	0.41 ± 0.08
HS2TFS11	11	23053/12A-212	0.170	4.32	0.101	2.57	0.016 ± 0.003	0.41 ± 0.08
HS2TFS10	10	23053/12A-213	0.191	4.85	0.112	2.84	0.016 ± 0.003	0.41 ± 0.08
HS2TFS09	9	23053/12A-214	0.205	5.21	0.124	3.15	0.020 ± 0.004	0.51 ± 0.10
HS2TFS08	8	23053/12A-216	0.240	6.10	0.141	3.58	0.020 ± 0.004	0.51 ± 0.10
HS2TFS07	7	23053/12A-217	0.270	6.86	0.158	4.01	0.020 ± 0.004	0.51 ± 0.10
HS2TFS06	6	23053/12A-218	0.302	7.67	0.178	4.52	0.020 ± 0.004	0.51 ± 0.10
HS2TFS05	5	23053/12A-219	0.320	8.13	0.198	5.03	0.020 ± 0.004	0.51 ± 0.10
HS2TFS04	4	23053/12A-220	0.370	9.40	0.224	5.69	0.020 ± 0.004	0.51 ± 0.10
HS2TFS03	3	23053/12A-221	0.390	9.91	0.249	6.32	0.020 ± 0.004	0.51 ± 0.10
HS2TFS02	2	23053/12A-223	0.430	10.9	0.278	7.06	0.020 ± 0.004	0.51 ± 0.10
HS2TFS01	1	23053/12A-224	0.450	11.4	0.311	7.90	0.020 ± 0.004	0.51 ± 0.10
HS2TFS00	0	23053/12A-226	0.470	11.9	0.347	8.81	0.020 ± 0.004	0.51 ± 0.10

Certifications

- AMS-DTL-23053/12A, Class 3
- AMS 3585
- ASTM D2902 Type I
- FDA Compliant
- USP Class VI Compliant

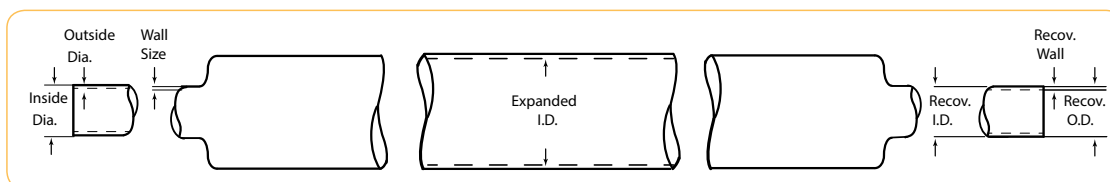

For detailed ordering information, please consult price list or contact Parflex® Division.

Parker Hannifin Corporation | Parflex® Division | Ravenna, Ohio | parker.com/pfd

www.comoso.com



B-71

PTFE Heat Shrinkable Tubing

Series 2:1 AWG: HS2TFS, HS2TFT, HS2TFL (cont.)

HS2TFT Thin Wall (2:1)

Part Number	Order Size AWG	Mil Spec*	Minimum Expanded I.D.		Maximum Recovered I.D.		Nominal Recovered Wall	
			inch	mm	inch	mm	inch	mm
HS2TFT30	30	23053/12A-301	0.034	0.86	0.015	0.38	0.009 ± 0.002	0.23 ± 0.05
HS2TFT28	28	23053/12A-302	0.038	0.97	0.018	0.46	0.009 ± 0.002	0.23 ± 0.05
HS2TFT26	26	23053/12A-303	0.046	1.16	0.022	0.56	0.010 ± 0.003	0.25 ± 0.08
HS2TFT24	24	23053/12A-304	0.050	1.27	0.027	0.69	0.010 ± 0.002	0.25 ± 0.08
HS2TFT22	22	23053/12A-305	0.055	1.40	0.032	0.81	0.012 ± 0.003	0.31 ± 0.08
HS2TFT20	20	23053/12A-306	0.060	1.52	0.039	0.99	0.012 ± 0.003	0.31 ± 0.08
HS2TFT19	19	23053/12A-307	0.065	1.65	0.043	1.09	0.012 ± 0.003	0.31 ± 0.08
HS2TFT18	18	23053/12A-308	0.076	1.93	0.049	1.25	0.012 ± 0.003	0.31 ± 0.08
HS2TFT17	17	23053/12A-309	0.085	2.16	0.054	1.37	0.012 ± 0.003	0.31 ± 0.08
HS2TFT16	16	23053/12A-310	0.093	2.36	0.061	1.55	0.012 ± 0.003	0.31 ± 0.08
HS2TFT15	15	23053/12A-311	0.110	2.79	0.067	1.70	0.012 ± 0.003	0.31 ± 0.08
HS2TFT14	14	23053/12A-312	0.120	3.05	0.072	1.83	0.012 ± 0.003	0.31 ± 0.08
HS2TFT13	13	23053/12A-313	0.140	3.56	0.080	2.03	0.012 ± 0.003	0.31 ± 0.08
HS2TFT12	12	23053/12A-314	0.150	3.81	0.089	2.26	0.012 ± 0.003	0.31 ± 0.08
HS2TFT11	11	23053/12A-316	0.170	4.32	0.101	2.57	0.012 ± 0.003	0.31 ± 0.08
HS2TFT10	10	23053/12A-317	0.191	4.85	0.112	2.84	0.012 ± 0.003	0.31 ± 0.08
HS2TFT09	9	23053/12A-318	0.205	5.21	0.124	3.15	0.015 ± 0.004	0.38 ± 0.10
HS2TFT08	8	23053/12A-320	0.240	6.10	0.141	3.58	0.015 ± 0.004	0.38 ± 0.10
HS2TFT07	7	23053/12A-321	0.270	6.86	0.158	4.01	0.015 ± 0.004	0.38 ± 0.10
HS2TFT06	6	23053/12A-322	0.302	7.67	0.178	4.52	0.015 ± 0.004	0.38 ± 0.10
HS2TFT05	5	23053/12A-323	0.320	8.13	0.198	5.03	0.015 ± 0.004	0.38 ± 0.10
HS2TFT04	4	23053/12A-324	0.370	9.40	0.224	5.69	0.015 ± 0.004	0.38 ± 0.10
HS2TFT03	3	23053/12A-325	0.390	9.91	0.249	6.32	0.015 ± 0.004	0.38 ± 0.10
HS2TFT02	2	23053/12A-327	0.430	10.9	0.278	7.06	0.015 ± 0.004	0.38 ± 0.10
HS2TFT01	1	23053/12A-328	0.450	11.4	0.311	7.90	0.015 ± 0.004	0.38 ± 0.10
HS2TFT00	0	23053/12A-330	0.470	11.9	0.347	8.81	0.015 ± 0.004	0.38 ± 0.10

*Dielectric Strength: ≥ 1,400 V/M, per ASTM D 149 short term test of 10 MIL thickness (Volts/MIL)

Certifications

- AMS-DTL-23053/12A, Class 3
- AMS 3585
- ASTM D2902 Type I
- FDA Compliant
- USP Class VI Compliant

HS2TFL Light Wall (2:1)

Part Number	Order Size AWG	Mil Spec*	Minimum Expanded I.D.		Maximum Recovered I.D.		Nominal Recovered Wall	
			inch	mm	inch	mm	inch	mm
HS2TFL24	24	23053/12A-404	0.050	1.27	0.025	0.64	0.006 ± 0.002	0.15 ± 0.05
HS2TFL22	22	23053/12A-405	0.055	1.40	0.031	0.79	0.006 ± 0.002	0.15 ± 0.05
HS2TFL20	20	23053/12A-406	0.060	1.52	0.038	0.97	0.006 ± 0.002	0.15 ± 0.05
HS2TFL19	19	23053/12A-407	0.065	1.65	0.043	1.09	0.006 ± 0.002	0.15 ± 0.05
HS2TFL18	18	23053/12A-408	0.076	1.93	0.046	1.17	0.006 ± 0.002	0.15 ± 0.05
HS2TFL17	17	23053/12A-409	0.085	2.16	0.054	1.37	0.006 ± 0.002	0.15 ± 0.05
HS2TFL16	16	23053/12A-410	0.093	2.36	0.057	1.45	0.006 ± 0.002	0.15 ± 0.05
HS2TFL15	15	23053/12A-411	0.110	2.79	0.063	1.60	0.006 ± 0.002	0.15 ± 0.05
HS2TFL14	14	23053/12A-412	0.120	3.05	0.072	1.83	0.008 ± 0.002	0.20 ± 0.05
HS2TFL13	13	23053/12A-413	0.140	3.56	0.080	2.03	0.008 ± 0.002	0.20 ± 0.05
HS2TFL12	12	23053/12A-414	0.150	3.81	0.089	2.26	0.008 ± 0.002	0.20 ± 0.05
HS2TFL11	11	23053/12A-416	0.170	4.32	0.099	2.51	0.008 ± 0.002	0.20 ± 0.05
HS2TFL10	10	23053/12A-417	0.191	4.85	0.110	2.79	0.008 ± 0.002	0.20 ± 0.05
HS2TFL09	9	23053/12A-418	0.205	5.21	0.122	3.10	0.008 ± 0.002	0.20 ± 0.05
HS2TFL08	8	23053/12A-420	0.240	6.10	0.139	3.53	0.008 ± 0.002	0.20 ± 0.05
HS2TFL07	7	23053/12A-421	0.270	6.86	0.154	3.91	0.008 ± 0.002	0.20 ± 0.05
HS2TFL06	6	23053/12A-422	0.302	7.67	0.172	4.37	0.010 ± 0.003	0.25 ± 0.08
HS2TFL05	5	23053/12A-423	0.320	8.13	0.192	4.88	0.010 ± 0.003	0.25 ± 0.08
HS2TFL04	4	23053/12A-424	0.370	9.40	0.214	5.44	0.010 ± 0.003	0.25 ± 0.08
HS2TFL03	3	23053/12A-425	0.390	9.91	0.241	6.12	0.010 ± 0.003	0.25 ± 0.08
HS2TFL02	2	23053/12A-427	0.430	10.9	0.270	6.88	0.010 ± 0.003	0.25 ± 0.08
HS2TFL01	1	23053/12A-428	0.450	11.4	0.301	7.65	0.010 ± 0.003	0.25 ± 0.08
HS2TFL00	0	23053/12A-430	0.470	11.9	0.347	8.81	0.012 ± 0.003	0.31 ± 0.08

*Dielectric Strength: ≥ 1,400 V/M, per ASTM D 149 short term test of 10 MIL thickness (Volts/MIL)

Certifications

- AMS-DTL-23053/12A, Class 4
- ASTM D2902 Type I
- FDA Compliant
- USP Class VI Compliant

For detailed ordering information, please consult price list or contact Parflex® Division.

Parker Hannifin Corporation | Parflex® Division | Ravenna, Ohio | parker.com/pfd

www.comoso.com



B-73

PTFE Heat Shrinkable Tubing

Series 4:1 HS4TFI



Applications/Markets



- Electrical Insulation
- Protective Cover
- Rollers
- Bulb Protection

Features

- Virgin Polytetrafluoroethylene resin
- 4:1 Shrink Ratio
- Chemically inert
- Lowest coefficient of friction
- Superior dielectric strength
- Exceptional heat resistance
- Self extinguishing
- Non-wetting

Certifications

- AMS-DTL-23053/12A, Class 5
- ASTM D2902 Type I
- AMS 3584A
- VWI, UL-83 (natural)
- FDA Compliant
- USP Class VI Compliant

Order Information

Example: HS4TFI5/8-NT

HS4TFI5/8-NT – Heat Shrink

HS4TFI5/8-NT – Shrink Ratio (4:1)

HS4TFI5/8-NT – PTFE

HS4TFI5/8-NT – Wall Type (Industrial Wall)

HS4TFI5/8-NT – Heat Shrink Size in inches (5/8")

HS4TFI5/8-NT – Natural

HS4TFI5/8-NT – Bulk Tubing

Notes

- Working Temperature: -500°F (260°C)
- Shrink Temperature: 662°F (350°C) for 10 minutes AMS-DTL-23053/12A
- For full recovery, expanded diameter should be 50% larger than the diameter of the object to be recovered over
- *Dielectric Strength: $\geq 1,400$ V/M, per ASTM D 149 short term test of 10 MIL thickness (Volts/MIL)
- PTFE Fractional Heat Shrink tubing is available in stock packaging of 4-ft. straight lengths
- Minimum quantities may apply
- Custom packaging, sizes, lengths and colors are quoted upon request

Colors

- ○ Natural, Opaque to translucent
- Colors available as custom run, see color code table

When ordering coiled tubing in colors, the color code is always followed by TC; when ordering cut lengths, the color code is followed by CC

ie HS4TFI5/8-2TC ie HS4TFI5/8-0CC48.0000

Color Code					
○	N	Natural	●	5	Green
●	0	Black	●	6	Blue
●	1	Brown	●	7	Violet
●	2	Red	●	8	Gray
●	3	Orange	○	9	White
●	4	Yellow			

HS4TFI PTFE Industrial Wall Heat Shrink Tubing (4:1)

Part Number	Order Size inch	Mil Spec*	Minimum Expanded I.D.		Maximum Recovered I.D.		Nominal Recovered Wall	
			inch	mm	inch	mm	inch	mm
HS4TFI5/64	5/64	23053/12A-501	0.078	1.98	0.025	0.64	0.009 ± 0.002	0.23 ± 0.05
HS4TFI1/8	1/8	23053/12A-502	0.125	3.18	0.037	0.94	0.012 ± 0.002	0.31 ± 0.05
HS4TFI3/16	3/16	23053/12A-503	0.187	4.75	0.050	1.27	0.012 ± 0.002	0.31 ± 0.05
HS4TFI1/4	1/4	23053/12A-504	0.250	6.35	0.063	1.60	0.012 ± 0.002	0.31 ± 0.05
HS4TFI5/16	5/16	23053/12A-505	0.312	7.92	0.078	1.98	0.012 ± 0.002	0.31 ± 0.05
HS4TFI3/8	3/8	23053/12A-506	0.375	9.52	0.096	2.44	0.012 ± 0.002	0.31 ± 0.05
HS4TFI7/16	7/16	23053/12A-507	0.438	11.1	0.112	2.84	0.012 ± 0.002	0.31 ± 0.05
HS4TFI1/2	1/2	23053/12A-508	0.500	12.7	0.144	3.66	0.015 ± 0.004	0.38 ± 0.10
HS4TFI5/8	5/8	23053/12A-510	0.625	15.9	0.178	4.52	0.015 ± 0.004	0.38 ± 0.10
HS4TFI3/4	3/4	23053/12A-512	0.750	19.1	0.224	5.70	0.015 ± 0.004	0.38 ± 0.10
HS4TFI7/8	7/8	23053/12A-513	0.875	22.2	0.244	6.20	0.015 ± 0.004	0.38 ± 0.10
HS4TFI1.00	1	23053/12A-514	1.000	25.4	0.278	7.06	0.015 ± 0.004	0.38 ± 0.10
HS4TFI1.25	1-1/4	23053/12A-515	1.250	31.8	0.347	8.81	0.015 ± 0.004	0.38 ± 0.10

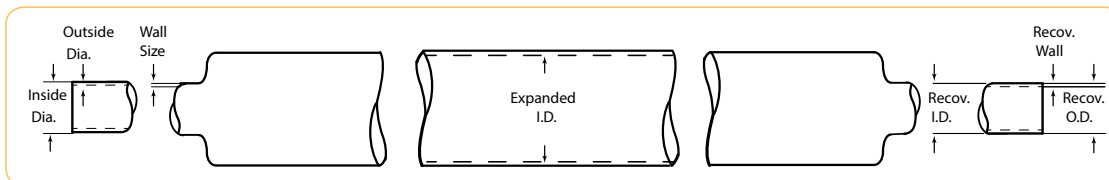

For detailed ordering information, please consult price list or contact Parflex® Division.



PTFE Convoluted

Series Convo-Tex®



Features

- Chemically inert
- Low coefficient of friction
- Very flexible
- Self extinguishing
- Non-wetting

Certifications

- AMS 3653E
- VW1, UL-83 (natural)
- FDA Compliant
- USP Class VI Compliant

Applications/Markets



- Fluid Transport
- Wire Harness
- Protection/Cable Core
- Robotics

Order Information

Example: CV01-1/8-NT

CV01-1/8-NT – Convoluted

CV01-1/8-NT – PTFE

CV01-1/8-NT – Size to Order (1/8")

CV01-1/8-NT – Color (N=Natural)

CV01-1/8-NT- "T" is bulk (for cuffed tubing, remove "T" and add length, ie. CV01-1/8-N1200 = 1" Convo, natural, cut 12" long)

Notes

- Working Temperature: -100°F to 500°F (-75°C to 260°C)
- Standard cuffs for Convo-Tex are sized on the Inside Diameter
- Wire wrap reinforcement can be added for increased pressure applications or when a tighter bend radius is needed
- Minimum quantities may apply
- Custom packaging, sizes, lengths and colors are quoted upon request

Colors

- ○ Natural, Opaque to Translucent
- Colors available as custom run, see color code table

Color Code					
○	N	Natural	●	5	Green
●	0	Black	●	6	Blue
●	1	Brown	●	7	Violet
●	2	Red	●	8	Gray
●	3	Orange	○	9	White
●	4	Yellow			

PTFE Convo-Tex® Convoluted

(Standard tubing is natural)

Part Number	Size To Order	Standard Cuff I.D. "A"		Standard Cuff Length "B"		Wall Thickness "C"		Min. Inside Diameter "D"		Max. Inside Diameter "D"		Max. Outside Diameter "E"		**Min. Bend Radius	
		inch	mm	inch	mm	inch	mm	inch	mm	inch	mm	inch	mm	inch	mm
CV01-1/8-NT	CONV-2	1/8	3.18	3/4	19.1	0.010	0.25	0.130	3.3	0.140	3.6	0.235	5.9	3/8	9.5
CV01-1/4-NT	CONV-4	1/4	6.35	3/4	19.1	0.015	0.38	0.181	4.6	0.188	4.8	0.320	8.1	1/2	12.7
CV01-5/16-NT	CONV-5	5/16	7.94	1	25.4	0.020	0.51	0.273	6.9	0.281	7.1	0.414	10.5	3/4	19.1
CV01-3/8-NT	CONV-6	3/8	9.53	1	25.4	0.020	0.51	0.303	7.7	0.312	7.9	0.450	11.4	1-3/4	44.4
CV01-1/2-NT	CONV-8	1/2	12.7	1	25.4	0.020	0.51	0.425	10.8	0.437	11.1	0.590	15.0	1-1/4	31.2
CV01-5/8-NT	CONV-10	5/8	15.9	1-1/4	31.8	0.025	0.64	0.485	12.3	0.500	12.7	0.660	16.8	1-1/2	38.1
CV01-3/4-NT	CONV-12	3/4	19.1	1-1/2	38.1	0.023	0.58	0.608	15.4	0.625	15.9	0.780	19.8	1-3/4	44.4
CV01-1.00-NT	CONV-16	1	25.4	2	50.8	0.030	0.76	0.849	21.6	0.875	22.2	1.100	27.9	2-1/4	57.2
CV01-1.25-NT	CONV-20	1-1/4	31.8	2-1/2	63.5	0.035	0.89	1.150	29.2	1.190	30.2	1.560	39.6	2-3/4	69.9
CV01-1.50-NT	CONV-24	1-1/2	38.1	2-1/2	63.5	0.040	1.02	1.410	35.8	1.490	37.8	1.910	48.5	3	76.2
CV01-2.00-NT	CONV-32	2	50.8	2-1/2	63.5	0.043	1.09	1.955	49.7	1.985	50.4	2.450	62.2	4-1/4	107.9
CV01-2.50-NT	CONV-40	2-1/2	63.5	2-1/2	63.5	0.062	1.57	2.460	62.5	2.540	64.5	3.210	81.6	5	127
CV01-3.00-NT	CONV-48	3	76.2	2-1/2	63.5	0.070	1.78	2.940	74.7	3.060	77.7	3.750	95.3	7	177.8
CV01-4.00-NT	CONV-64	4	101.6	2-1/2	63.5	0.070	1.78	3.940	100.1	4.060	103.1	4.750	120.6	9	228.6

** Minimum 36" length.

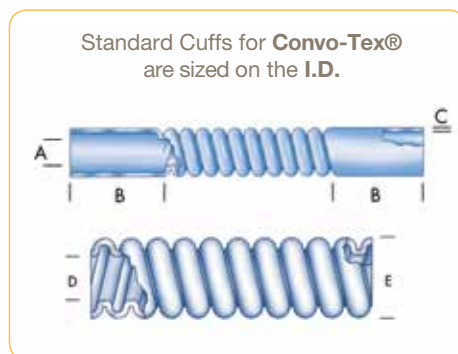

For detailed ordering information, please consult price list or contact Parflex® Division.

Parker Hannifin Corporation | Parflex® Division | Ravenna, Ohio | parker.com/pfdwww.comoso.com

B-77

PTFE Convoluted

Series Low Profile and Heavy Wall

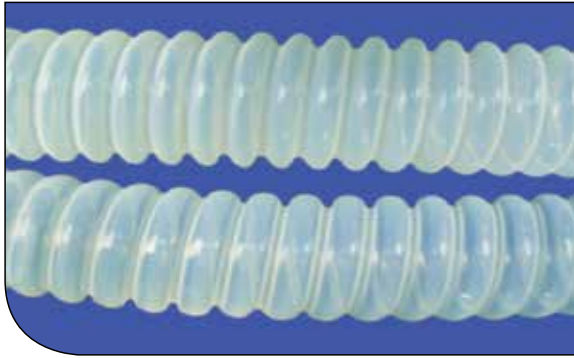

Applications/Markets



- Fluid Handling
- Harnesses
- Lab Equipment
- Robotics

Order Information

Example: CVH01-1/8-NT

CVH01-1/8-NT – CVH - Heavywall Convoluted
 – CVL Low Profile Convoluted

CVH01-1/8-NT – **PTFE**

CVH01-**1/8**-NT – **Size to Order (1/8")**

CVH01-1/8-**NT** – **Color (N=Natural)**

CVH01-1/8-**NT**- "**T**" is **bulk** (for cuffed tubing, remove "**T**" and add length, ie. CVH01-1/8-N1200 = 1" Heavy Wall Convo, natural, cut 12" long)

Notes

- Working Temperature: 500°F (260°C)
- Standard cuffs for Convo-Tex are sized on the Inside Diameter
- Wire wrap reinforcement can be added for increased pressure applications or when a tighter bend radius is needed
- Minimum quantities may apply
- Custom packaging, sizes, lengths, cuffs and colors are quoted upon request

Features

- Chemically inert
- Low coefficient of friction
- Very flexible
- Self extinguishing
- Non-wetting

Low Profile

- Larger inside diameter
- Increased Flow

Heavy Wall

- Reinforces the strength of the tube allowing for braiding or covering, flanging or flaring
- Handles higher vacuum

Certifications

- AMS 3653E
- VW1, UL-83
- FDA Compliant
- USP Class VI Compliant

Colors

- ○ Natural, Opaque to Translucent
- Colors available as custom run, see color code table

Color Code					
○	N	Natural	●	5	Green
●	0	Black	●	6	Blue
●	1	Brown	●	7	Violet
●	2	Red	●	8	Gray
●	3	Orange	○	9	White
●	4	Yellow			

PTFE Low Profile Convoluted

(Standard tubing is natural)

Part Number	Size To Order	Min. Inside Diameter		Max. Inside Diameter		Max. Outside Diameter		Wall Thickness		**Min. Bend Radius	
		inch	mm	inch	mm	inch	mm	inch	mm	inch	mm
CVL01-3/8-NT	3/8	0.394	10.0	0.406	10.3	0.560	14.2	0.023	0.58	1/2	13
CVL01-1/2-NT	1/2	0.490	12.5	0.510	13.0	0.700	17.8	0.025	0.64	3/4	19
CVL01-3/4-NT	3/4	0.740	18.8	0.760	19.3	0.980	24.9	0.035	0.89	1.88	48
CVL01-1.00-NT	1	0.990	25.1	1.010	25.7	1.260	32.0	0.035	0.89	2-1/4	57
CVL01-1.25-NT	1-1/4	1.210	30.7	1.250	31.8	1.539	39.1	0.035	0.89	3	76
CVL01-1.50-NT	1-1/2	1.520	38.6	1.540	39.1	1.870	47.5	0.044	1.12	3-1/2	89
CVL01-1.75-NT	1-3/4	1.690	42.9	1.750	44.5	2.100	53.3	0.040	1.02	4-1/4	108
CVL01-2.00-NT	2	2.010	51.1	2.030	51.6	2.370	60.2	0.043	1.09	4-3/4	121

** Minimum 36 length.

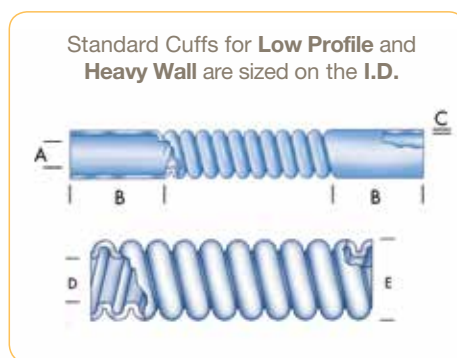
**PTFE Heavy Wall Convoluted**

(Standard tubing is natural)

Part Number	Size To Order	Min. Inside Diameter		Max. Inside Diameter		Max. Outside Diameter		Wall Thickness		**Min. Bend Radius	
		inch	mm	inch	mm	inch	mm	inch	mm	inch	mm
CVH01-1/4-NT	1/4	0.257	6.5	0.265	6.7	0.415	10.5	0.025	0.38	3/4	19
CVH01-3/8-NT	3/8	0.335	8.5	0.345	8.8	0.510	13.0	0.025	0.64	1	25
CVH01-1/2-NT	1/2	0.454	11.5	0.466	11.8	0.700	17.8	0.035	0.89	1-1/2	38
CVH01-3/4-NT	3/4	0.683	17.4	0.701	17.8	1.010	25.7	0.500	1.27	1.88	48
CVH01-1.00-NT	1	0.841	21.4	0.859	21.8	1.210	30.7	0.053	1.35	2-1/2	64
CVH01-1.25-NT	1-1/4	1.125	28.6	1.145	29.1	1.610	40.9	0.062	1.57	3.13	79
CVH01-1.50-NT	1-1/2	1.420	36.1	1.480	37.6	1.880	47.8	0.062	1.57	3-3/4	95
CVH01-1.75-NT	1-3/4	1.540	39.1	1.600	40.6	2.100	53.3	0.062	1.57	4-1/2	114
CVH01-2.00-NT	2	1.770	45.0	1.830	46.5	2.432	61.8	0.062	1.57	4-3/4	120
CVH01-2.50-NT	2-1/2	2.460	62.5	2.540	64.5	3.210	81.5	0.062	1.57	5	127
CVH01-3.00-NT	3	2.940	74.7	3.060	77.7	3.750	95.3	0.062	1.57	7	178
CVH01-4.00-NT	4	3.90	100	4.060	103	4.750	121	0.070	1.77	9	229

** Minimum 36 length.

For detailed ordering information, please consult price list or contact Parflex® Division.

Parker Hannifin Corporation | Parflex® Division | Ravenna, Ohio | parker.com/pfdwww.comoso.com

B-79

PTFE Convoluted

Series SAE AS81914/1 and SAE AS81914/2



Features

- Chemically inert
- Low coefficient of friction
- Very flexible
- Self extinguishing
- Non-wetting

Certifications

- AMS 3653E
- SAE AS81914/1
- SAE AS81914/2
- FDA Compliant

Applications/Markets



- Fluid Handling
- Harnesses
- Crush Resistant Cover
- Robotics

Order Information

Example: 81914/1-1010-0TC

81914/1-1010-0TC – SAE AS81914 Convoluted

81914/1-1010-0TC – PTFE

81914/1-1010-0TC – Helical Convolutions

81914/1-1010-0TC – Size (10=1.000")

81914/1-1010-0TC – Color (0=Black)

81914/1-1010-0TC – "T" is bulk - (for cuffed tubing, remove "T" and add length, ie. 81914/1-1010-01200 = 187" Convo, black, cut 12" long

Notes

- Working Temperature: 500°F (260°C)
- Tubing is provided in black without cuffs direct from inventory
- Stock packaging is random coils
- Also available in close convolution 81914/2
- Minimum quantities may apply
- Custom packaging, sizes, lengths, cuffs and colors are quoted upon request

Colors

- ● Black
- Colors available as custom run, see color code table

When ordering convoluted tubing in colors, the "N" designation for natural should be replaced by the correct color designator;

ie 81914/1-101-0T (black bulk tubing)

ie 81914/1-101-01200 (black tubing - 12 inches long)

Color Code					
○	N	Natural	●	5	Green
●	0	Black	●	6	Blue
●	1	Brown	●	7	Violet
●	2	Red	●	8	Gray
●	3	Orange	○	9	White
●	4	Yellow			

PTFE Convoluted Tubing (SAE AS81914/1)

(Standard tubing is black)

Part Number	MIL Spec*	Maximum Inside Diameter		Minimum Inside Diameter		Maximum Outside Diameter		Maximum Wall Thickness		Minimum Bend Radius		Pitch ±1	Weight	
		inch	mm	inch	mm	inch	mm	inch	mm	inch	mm		lb./100 ft.	kg./100 mtr.
81914/1-1001-OTC	-1	0.188	4.78	0.181	4.6	0.320	8.13	0.023	0.584	1/2	13	8	2	2.98
81914/1-1002-OTC	-2	0.281	7.14	0.273	6.93	0.414	10.5	0.027	0.686	3/4	19	7.5	2.9	4.31
81914/1-1003-OTC	-3	0.312	7.93	0.303	7.7	0.450	11.4	0.027	0.686	7/8	22	7.5	3.6	5.36
81914/1-1004-OTC	-4	0.375	9.53	0.364	9.25	0.530	13.5	0.029	0.737	1	25	7	4.2	6.25
81914/1-1005-OTC	-5	0.437	11.1	0.425	10.8	0.590	15.0	0.029	0.737	1-1/4	32	7	4.9	7.29
81914/1-1006-OTC	-6	0.500	12.7	0.485	12.3	0.660	16.8	0.029	0.737	1-1/2	38	7	5.2	7.74
81914/1-1007-OTC	-7	0.625	15.9	0.608	15.4	0.780	19.9	0.035	0.889	1-3/4	44	7	6.9	10.3
81914/1-1008-OTC	-8	0.750	19.1	0.730	18.5	0.975	24.8	0.035	0.889	1.88	48	6	10.4	15.5
81914/1-1009-OTC	-9	0.875	22.2	0.850	21.6	1.100	27.9	0.035	0.889	2-1/4	57	6	11.3	16.8
81914/1-1010-OTC	-10	1.000	25.4	0.975	24.8	1.260	32.0	0.035	0.889	2-1/2	64	4.5	12.6	18.8
81914/1-1011-OTC	-11	1.125	28.6	1.100	27.9	1.390	35.3	0.035	0.889	2-3/4	70	4.5	13.8	20.5
81914/1-1012-OTC	-12	1.250	31.8	1.210	30.7	1.539	39.1	0.035	0.889	3	76	4	15.5	23.1
81914/1-1013-OTC	-13	1.500	38.1	1.440	36.6	1.850	47.0	0.040	1.020	3.75	95	4	21.7	32.3
81914/1-1014-OTC	-14	1.750	44.5	1.690	42.9	2.100	53.3	0.045	1.140	4.25	108	4	25.3	37.6
81914/1-1015-OTC	-15	2.000	50.8	1.940	49.3	2.350	59.7	0.045	1.140	4.75	121	4	29	43.2

*PTFE convoluted tubing is provided in BLACK without cuffs direct from the factory. Black part numbers are designated with "OT" and Natural part numbers are designated with "NT" after the Mil Spec number (ie 81914/1-1014-OT).

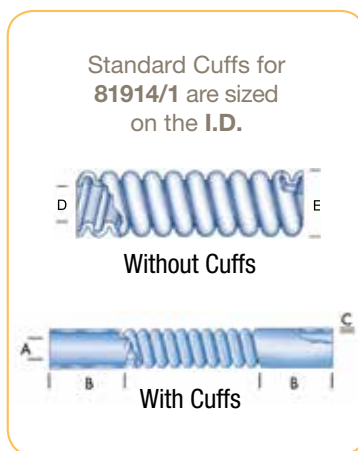

For detailed ordering information, please consult price list or contact Parflex® Division.

Parker Hannifin Corporation | Parflex® Division | Ravenna, Ohio | parker.com/pfd

www.comoso.com



B-81

FEP Tubing

Series Fractional & Metric: 103, 203



Features

- Virgin Fluorinated Ethylene Propylene resin
- Translucent
- Chemically inert
- Long continuous lengths
- Low coefficient of friction
- Self extinguishing
- Non-wetting
- Weldable

Certifications/Compliance

- ASTM D3307-10
- ASTM D2116-07
- VW-1, UL-83 (natural)
- FDA Compliant
- USP Class VI Compliant

Applications/Markets



- Nitrogen Transfer
- Ozone Sampling
- Optical Sensor
- Laboratory
- Down Hole Pump
- Food & Beverage
- Catheter Repair
- Syringe Tips

Order Information

Example: 103-0250031-N-100

103-0250031-N-100 – **Fractional**

103-0250031-N-100 – **FEP**

103-**0250**031-N-100 – **Tube O.D.** in inches (**1/4"**)

103-0250**031**-N-100 – **Tube Wall Thickness** in inches (**.031"**)

103-0250031-**N**-100 – **Natural**

103-0250031-N-**100** – **Package Quantity** in feet (**100'**)

Fittings

Fittings available for sizes 1/8" up to 1"

Parker Fittings available from:
Fluid System Connectors Division
Otsego, MI

(269) 694-2550

(269) 692-6634 FAX

FSC Product Families:

- Compression
- Compress-Align®
- TrueSeal™

Notes

- Working Temperature:
-100°F to 400°F (-75°C to 204°C)
- Working pressure calculated using a Design Factor of 4 at
73°F (23°C)
- Custom packaging and sizes are quoted upon request
- Package quantities are not continuous

Options

- Smoothbore
- Convoluted
- Corrugated
- Retractable Coils
- Paratubing

Colors









- ○ Natural, Translucent
- Colors available as custom run, see color code table

Color Code					
○	N	Natural	●	5	Green
●	0	Black	●	6	Blue
●	1	Brown	●	7	Violet
●	2	Red	●	8	Gray
●	3	Orange	○	9	White
●	4	Yellow			











A Hose
 B Tubing Fluoropolymer
 C Coiled Air Hose & Fittings
 D Transportation
 E Fittings
 F Tooling, Equipment & Accessories
 G General Technical









103 FEP Industrial Wall Fractional Size Tubing

Part Number	Order Size	Nominal O.D.					Nominal I.D.					Reference Wall		Working Pressure		Burst Pressure		Min. Bend Radius		Vac. Rating	Weight	
		inch	inch	tol.	mm	tol.	inch	tol.	mm	tol.	inch	mm	psi 73°F	bar 23°C	psi 73°F	bar 23°C	inch	mm	at 73°F		lb. per ft.	kg. per m.
#																						
103-0094031	3/32	0.094	±0.005	2.40	±0.127	0.031	±0.002	0.79	±0.051	0.031	0.79	630	43	2520	174	0.500	13	28	0.006	0.009		
103-0125031	1/8	0.125	±0.003	3.18	±0.076	0.062	±0.003	1.57	±0.076	0.031	0.79	470	32	1880	130	0.375	10	28	0.009	0.013		
103-0156031	5/32	0.157	±0.005	3.99	±0.127	0.094	±0.005	2.39	±0.127	0.031	0.79	360	25	1440	99	0.375	10	28	0.011	0.017		
103-0188031	3/16	0.188	±0.005	4.78	±0.127	0.125	±0.005	3.18	±0.127	0.031	0.79	290	20	1160	80	0.750	19	28	0.014	0.021		
103-0250031	1/4	0.250	±0.005	6.35	±0.127	0.188	±0.005	4.78	±0.127	0.031	0.79	210	14	840	58	1.750	44	28	0.020	0.030		
103-0312031	5/16	0.312	±0.005	7.92	±0.127	0.250	±0.005	6.35	±0.127	0.031	0.79	160	11	640	44	2.250	57	28	0.025	0.038		
103-0375031	3/8	0.375	±0.005	9.52	±0.127	0.312	±0.005	7.92	±0.127	0.031	0.79	130	9	520	36	2.750	70	28	0.031	0.047		
103-0438031	7/16	0.438	±0.005	11.13	±0.127	0.375	±0.005	9.52	±0.127	0.031	0.79	110	8	440	30	4.000	102	28	0.037	0.055		
103-0500031	1/2	0.500	±0.006	12.70	±0.152	0.438	±0.006	11.13	±0.152	0.031	0.79	90	6	360	25	4.000	102	28	0.043	0.063		
103-0563031	9/16	0.563	±0.006	14.30	±0.152	0.500	±0.006	12.70	±0.152	0.031	0.79	80	6	320	22	5.000	127	28	0.054	0.080		

103 FEP Heavy Wall Fractional Size Tubing

Part Number	Order Size	Nominal O.D.					Nominal I.D.					Reference Wall		Working Pressure		Burst Pressure		Min. Bend Radius		Vac. Rating	Weight	
		inch	inch	tol.	mm	tol.	inch	tol.	mm	tol.	inch	mm	psi 73°F	bar 23°C	psi 73°F	bar 23°C	inch	mm	at 73°F		lb. per ft.	kg. per m.
#																						
103-0188062	3/16	0.188	±0.005	4.78	±0.127	0.064	±0.005	1.63	±0.127	0.062	1.57	630	43	2520	174	0.250	6	28	0.023	0.034		
103-0250040	1/4	0.250	±0.005	6.35	±0.127	0.170	±0.005	4.32	±0.127	0.040	1.02	280	19	1120	77	1.250	32	28	0.025	0.037		
103-0250047	1/4	0.250	±0.005	6.35	±0.127	0.156	±0.005	3.96	±0.127	0.047	1.19	340	23	1360	94	0.750	19	28	0.028	0.042		
103-0250062	1/4	0.250	±0.005	6.35	±0.127	0.125	±0.005	3.18	±0.127	0.062	1.57	470	32	1880	130	0.750	19	28	0.034	0.051		
103-0312062	5/16	0.312	±0.005	7.92	±0.127	0.188	±0.005	4.78	±0.127	0.062	1.57	360	25	1440	99	1.375	35	28	0.045	0.068		
103-0375062	3/8	0.375	±0.005	9.52	±0.127	0.250	±0.005	6.35	±0.127	0.062	1.57	290	20	1160	80	1.500	38	28	0.057	0.085		
103-0438062	7/16	0.438	±0.005	11.13	±0.127	0.312	±0.005	7.92	±0.127	0.062	1.57	250	17	1000	69	2.625	67	28	0.068	0.102		
103-0500062	1/2	0.500	±0.005	12.70	±0.127	0.375	±0.005	9.53	±0.127	0.062	1.57	210	14	840	58	2.125	54	28	0.079	0.119		
103-0625062	5/8	0.625	±0.006	15.88	±0.152	0.500	±0.006	12.70	±0.152	0.062	1.57	160	11	640	44	3.000	76	28	0.102	0.152		
103-0750062	3/4	0.750	±0.006	19.05	±0.152	0.625	±0.006	15.88	±0.152	0.062	1.57	130	9	520	36	6.000	152	28	0.125	0.186		
103-1000062	1	1.000	±0.010	25.40	±0.254	0.875	±0.010	22.22	±0.254	0.062	1.57	90	6	360	25	8.000	203	28	0.170	0.254		

203 Metric FEP Tubing

Part Number	Order Size	Nominal O.D.					Nominal I.D.					Reference Wall		Working Pressure		Burst Pressure		Min. Bend Radius		Vac. Rating	Weight	
		mm	mm	tol.	inch	tol.	mm	tol.	inch	tol.	mm	inch	bar 23°C	psi 73°F	bar 23°C	psi 73°F	mm	inch	at 73°F		kg. per m.	lb. per ft.
#																						
203-0300100	3	3	±0.11	0.118	±0.004	1	±0.11	0.039	±0.004	1	0.039	27	390	108	1560	6	0.250	28	0.014	0.009		
203-0400100	4	4	±0.11	0.157	±0.004	2	±0.11	0.079	±0.004	1	0.039	20	290	80	1160	13	0.500	28	0.020	0.014		
203-0500100	5	5	±0.11	0.197	±0.004	3	±0.11	0.118	±0.004	1	0.039	15	220	61	880	19	0.750	28	0.027	0.018		
203-0600100	6	6	±0.13	0.236	±0.005	4	±0.13	0.157	±0.005	1	0.039	12	180	50	720	29	1.125	28	0.034	0.023		
203-0700100	7	7	±0.13	0.276	±0.005	5	±0.13	0.197	±0.005	1	0.039	10	150	41	600	44	1.750	28	0.041	0.027		
203-0800100	8	8	±0.13	0.315	±0.005	6	±0.13	0.236	±0.005	1	0.039	9	130	36	520	51	2.000	28	0.047	0.032		
203-0900100	9	9	±0.13	0.354	±0.005	7	±0.13	0.275	±0.005	1	0.039	8	110	30	440	54	2.125	28	0.054	0.036		
203-1000100	10	10	±0.13	0.393	±0.005	8	±0.13	0.315	±0.005	1	0.039	7	100	28	400	70	2.750	28	0.061	0.041		
203-1200100	12	12	±0.15	0.472	±0.006	10	±0.15	0.394	±0.006	1	0.039	6	80	22	320	76	3.000	28	0.074	0.050		

For detailed ordering information, please consult price list or contact Parflex® Division.

Parker Hannifin Corporation | Parflex® Division | Ravenna, Ohio | parker.com/pfd

www.comoso.com



B-83

FEP Heat Shrinkable Tubing

Series 1.3:1 HS1.3FEP

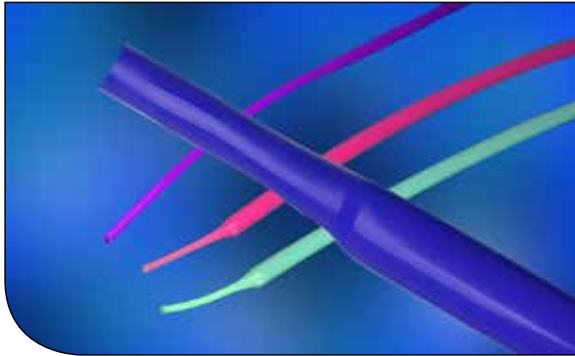

Features

- Easier to shrink than PTFE
- Chemically inert
- Low coefficient of friction
- Superior dielectric strength
- Good heat resistance
- Self extinguishing
- Non-wetting

Certifications

- AMS-DTL-23053/11A, Class 1
- ASTM D2902 Type II
- ASTM D3296-03
- VW-1, UL-83 (natural)
- FDA Compliant
- USP Class VI Compliant

Applications/Markets



- Protective Cover
- UV Light Covering
- Product Testing
- Rollers

Order Information

Example: HS1.3FEP24-0CC48.000

HS1.3FEP24-0CC48.000 – Heat Shrink

HS1.3FEP24-0CC48.000 – Shrink Ratio (1.3:1)

HS1.3FEP24-0CC48.000 – FEP

HS1.3FEP24-0CC48.000 – Heat Shrink Size in AWG

(AWG 24) (For inch size use inch (3/8"))

HS1.3FEP24-0CC48.000 – Black

HS1.3FEP24-0CC48.000 – Package Quantity in feet (48")

Notes

- Working Temperature: 400°F (204°C)
- Shrink Temperature:
1" Dia. and below : 410°F (210°C)
Over 1" Dia. : 430°F (221°C)
- *Dielectric Strength: $\geq 2,000$ V/M, per ASTM D 149 short term test of 10 MIL thickness (Volts/MIL)
- Heat Shrink tubing is available in stock packaging of 4-ft. straight lengths
- Minimum quantities may apply
- Custom packaging, sizes, lengths and colors are quoted upon request

Colors

- ○ Natural, Translucent
- Colors available as custom run, see color code table

When ordering coiled tubing in colors, the color code is always followed by TC; when ordering cut lengths, the color code is followed by CC
ie HS1.3FEP24-2TC
ie HS1.3FEP24-0CC48.000

Color Code					
○	N	Natural	●	5	Green
●	0	Black	●	6	Blue
●	1	Brown	●	7	Violet
●	2	Red	●	8	Gray
●	3	Orange	○	9	White
●	4	Yellow			

HS1.3FEP AWG Heat Shrink Tubing (1.3:1)

Part Number	Order Size AWG	Mil Spec*	Minimum Expanded I.D.		Maximum Recovered I.D.		Nominal Recovered Wall	
			inch	mm	inch	mm	inch	mm
HS1.3FEP24	24	23053/11A-101	0.031	0.79	0.027	0.69	0.008 ± 0.002	0.20 ± 0.05
HS1.3FEP22	22	23053/11A-102	0.036	0.91	0.032	0.81	0.008 ± 0.002	0.20 ± 0.05
HS1.3FEP20	20	23053/11A-103	0.045	1.14	0.039	0.99	0.008 ± 0.002	0.20 ± 0.05
HS1.3FEP18	18	23053/11A-104	0.060	1.52	0.049	1.25	0.008 ± 0.002	0.20 ± 0.05
HS1.3FEP16	16	23053/11A-105	0.075	1.90	0.061	1.55	0.009 ± 0.002	0.23 ± 0.05
HS1.3FEP14	14	23053/11A-106	0.092	2.34	0.072	1.83	0.009 ± 0.002	0.23 ± 0.05
HS1.3FEP12	12	23053/11A-107	0.115	2.92	0.089	2.26	0.009 ± 0.002	0.23 ± 0.05
HS1.3FEP10	10	23053/11A-108	0.141	3.58	0.114	2.90	0.010 ± 0.003	0.25 ± 0.08
HS1.3FEP09	9	23053/11A-109	0.158	4.01	0.124	3.15	0.010 ± 0.003	0.25 ± 0.08
HS1.3FEP08	8	23053/11A-110	0.180	4.57	0.143	3.63	0.010 ± 0.003	0.25 ± 0.08
HS1.3FEP07	7	23053/11A-111	0.197	5.00	0.158	4.01	0.011 ± 0.004	0.28 ± 0.10
HS1.3FEP06	6	23053/11A-112	0.225	5.72	0.180	4.57	0.011 ± 0.004	0.28 ± 0.10
HS1.3FEP05	5	23053/11A-113	0.248	6.30	0.198	5.03	0.011 ± 0.004	0.28 ± 0.10
HS1.3FEP04	4	23053/11A-114	0.290	7.37	0.226	5.74	0.011 ± 0.004	0.28 ± 0.10
HS1.3FEP03	3	23053/11A-115	0.310	7.87	0.249	6.32	0.011 ± 0.003	0.28 ± 0.08
HS1.3FEP02	2	23053/11A-116	0.365	9.27	0.280	7.11	0.012 ± 0.004	0.31 ± 0.10
HS1.3FEP01	1	23053/11A-117	0.400	10.2	0.311	7.90	0.012 ± 0.004	0.31 ± 0.10
HS1.3FEP00	0	23053/11A-118	0.440	11.2	0.349	8.86	0.012 ± 0.004	0.31 ± 0.10

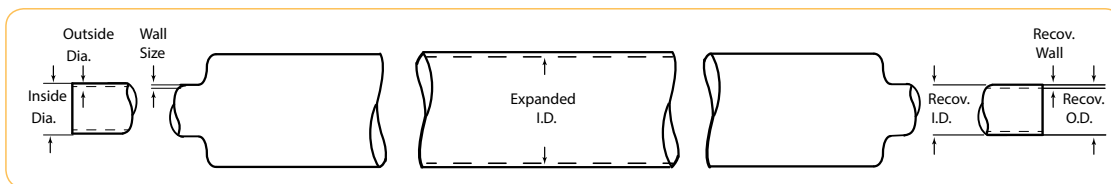

HS1.3FEP Fractional Heat Shrink Tubing (1.3:1)

Part Number	Order Size inch	Mil Spec*	Minimum Expanded I.D.		Maximum Recovered I.D.		Nominal Recovered Wall	
			inch	mm	inch	mm	inch	mm
HS1.3FEP3/8	3/8	23053/11A-119	0.500	12.7	0.383	9.73	0.015 ± 0.004	0.38 ± 0.10
HS1.3FEP7/16	7/16	23053/11A-120	0.580	14.7	0.448	11.4	0.020 ± 0.004	0.51 ± 0.10
HS1.3FEP1/2	1/2	23053/11A-121	0.666	16.9	0.510	13.0	0.020 ± 0.004	0.51 ± 0.10
HS1.3FEP5/8	5/8	23053/11A-122	0.830	21.1	0.637	16.2	0.025 ± 0.004	0.64 ± 0.10
HS1.3FEP3/4	3/4	23053/11A-123	1.000	25.4	0.764	19.4	0.030 ± 0.004	0.76 ± 0.10
HS1.3FEP7/8	7/8	23053/11A-124	1.170	29.7	0.891	22.6	0.035 ± 0.004	0.89 ± 0.10
HS1.3FEP1.00	1	23053/11A-126	1.330	33.8	1.020	25.9	0.035 ± 0.004	0.89 ± 0.10
HS1.3FEP1.13	1-1/8	23053/11A-133	1.500	38.1	1.145	29.1	0.035 ± 0.004	0.89 ± 0.10
HS1.3FEP1.25	1-1/4	23053/11A-134	1.666	42.3	1.270	32.3	0.035 ± 0.004	0.89 ± 0.10
HS1.3FEP1.38	1-3/8	23053/11A-135	1.833	46.6	1.390	35.3	0.035 ± 0.004	0.89 ± 0.10
HS1.3FEP1.50	1-1/2	23053/11A-136	2.000	50.8	1.520	38.6	0.035 ± 0.004	0.89 ± 0.10

For detailed ordering information, please consult price list or contact Parflex® Division.

FEP Heat Shrinkable Tubing

Series 1.67:1 HS1.6FEP

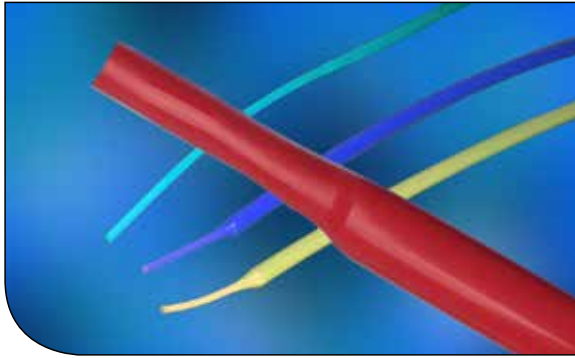

Features

- Easier to shrink than PTFE
- Chemically inert
- Low coefficient of friction
- Superior dielectric strength
- Good heat resistance
- Self extinguishing
- Non-wetting

Certifications

- AMS-DTL-23053/11A, Class 2
- ASTM 2902 Type II
- ASTM D3296-03
- VW-1, UL-83 (natural)
- FDA Compliant
- USP Class VI Compliant

Applications/Markets



- Protective Cover
- UV Light Covering
- Product Testing
- Rollers

Order Information

Example: HS1.6FEP3/32-NC48.000

HS1.6FEP3/32-NC48.000 – Heat Shrink

HS1.6FEP3/32-NC48.000 – Shrink Ratio (1.67:1)

HS1.6FEP3/32-NC48.000 – FEP

HS1.6FEP3/32-NC48.000 – Heat Shrink Size in inches (3/32")

HS1.6FEP3/32-NC48.000 – Natural

HS1.6FEP3/32-NC48.000 – Cut Tubing

HS1.6FEP3/32-NC48.000 – Package Quantity in feet (48")

Notes

- Working Temperature: 400°F (204°C)
- Shrink Temperature:
1" Dia. and below: 410°F (210°C)
Over 1" Dia.: 430°F (221°C)
- *Dielectric Strength: $\geq 2,000$ V/M, per ASTM D 149 short term test of 10 MIL thickness (Volts/MIL)
- Heat Shrink tubing is available in stock packaging of 4-ft. straight lengths
- Minimum quantities may apply
- Custom packaging, sizes, lengths and colors are quoted upon request

Colors

- ○ Natural, Translucent
- Colors available as custom run, see color code table

When ordering coiled tubing in colors, the color code is always followed by TC; when ordering cut lengths, the color code is followed by CC
ie HS1.6FEP3/32-2TC
ie HS1.6FEP3/32-0CC48.000

Color Code					
○	N	Natural	●	5	Green
●	0	Black	●	6	Blue
●	1	Brown	●	7	Violet
●	2	Red	●	8	Gray
●	3	Orange	○	9	White
●	4	Yellow			

HS1.6FEP Fractional Heat Shrink Tubing (1.67:1)

Part Number	Order Size inch	Mil Spec*	Minimum Expanded I.D.		Maximum Recovered I.D.		Nominal Recovered Wall	
			inch	mm	inch	mm	inch	mm
HS1.6FEP3/32	3/32	23053/11A-201	0.093	2.36	0.056	1.42	0.008 ± 0.003	0.20 ± 0.08
HS1.6FEP1/8	1/8	23053/11A-202	0.125	3.18	0.075	1.90	0.010 ± 0.003	0.25 ± 0.08
HS1.6FEP3/16	3/16	23053/11A-203	0.188	4.78	0.115	2.92	0.010 ± 0.003	0.25 ± 0.08
HS1.6FEP1/4	1/4	23053/11A-204	0.250	6.35	0.150	3.81	0.010 ± 0.003	0.25 ± 0.08
HS1.6FEP3/8	3/8	23053/11A-205	0.375	9.52	0.225	5.72	0.012 ± 0.003	0.31 ± 0.08
HS1.6FEP1/2	1/2	23053/11A-206	0.500	12.7	0.300	7.62	0.015 ± 0.004	0.38 ± 0.10
HS1.6FEP3/4	3/4	23053/11A-207	0.750	19.1	0.450	11.4	0.020 ± 0.004	0.51 ± 0.10
HS1.6FEP1.00	1	23053/11A-208	1.000	25.4	0.600	15.2	0.025 ± 0.005	0.64 ± 0.13
HS1.6FEP1.50	1-1/2	23053/11A-209	1.500	38.1	0.900	22.9	0.030 ± 0.005	0.76 ± 0.13
HS1.6FEP2.00	2	23053/11A-210	2.000	50.8	1.200	30.5	0.030 ± 0.005	0.76 ± 0.13

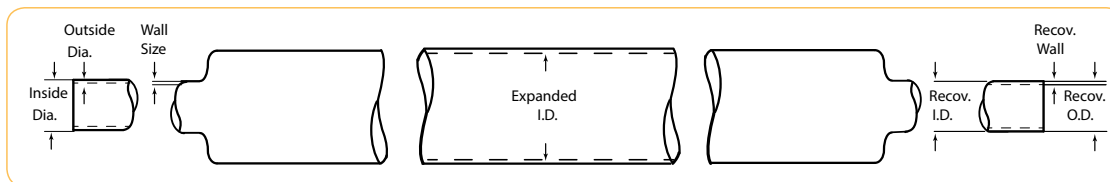

For detailed ordering information, please consult price list or contact Parflex® Division.

Parker Hannifin Corporation | Parflex® Division | Ravenna, Ohio | parker.com/pfd

www.comoso.com



B-87

FEP Heat Shrinkable Roll Cover

Series 1.25:1 HS1.25FEP



Features

- Extends roller life
- Eliminates roller build up and picking
- Low coefficient of friction
- Flexible
- Good heat resistance

Certifications

- ASTM D2902 Type II
- VW-1, UL-83 (natural)

Applications/Markets



- Protective Cover
- Rollers

Order Information

Example: HS1.25FEP3.50-NC48.000

HS1.25FEP3.50-NC48.000 – Heat Shrink

HS1.25FEP3.50-NC48.000 – Shrink Ratio (1.25:1)

HS1.25FEP3.50-NC48.000 – FEP

HS1.25FEP3.50-NC48.000 – Heat Shrink Expanded

Size inches (3 1/2 in)

HS1.25FEP3.50-NC48.000 – Natural

HS1.25FEP3.50-NC48.000 – Cut Tubing

HS1.25FEP3.50-NC48.000 – Package Quantity in feet (48")

Notes

- Working Temperature: 400°F (204°C)
- Shrink Temperature:
347°F (175°C) for 10 minutes - For high temperatures 500°F (260°C), PFA roll covers are available
- Dielectric Strength: $\geq 2,000$ V/M, per ASTM D 149 short term test of 10 MIL thickness (Volts/MIL)
- Roll Cover is available in stock packaging of 4-ft. straight lengths
- Custom packaging, sizes, lengths and colors are quoted upon request
- For adhesion purposes, roll covers must be etched; Etching is available on the inside diameter, outside diameter or both
- Minimum quantities may apply

Colors

- ○ Natural, Translucent

HS1.25.1 FEP Roll Cover

Part Number	Order Size	Minimum Expanded I.D.		Maximum Recovered I.D.		Nominal Recovered Wall	
		inch	mm	inch	mm	inch	mm
HS1.25FEP1/2	1/2	0.550	14.0	0.440	11.2	0.020 ± 0.004	0.508 ± 0.10
HS1.25FEP5/8	5/8	0.700	17.8	0.540	13.7	0.020 ± 0.004	0.508 ± 0.10
HS1.25FEP3/4	3/4	0.800	20.3	0.640	16.3	0.020 ± 0.004	0.508 ± 0.10
HS1.25FEP7/8	7/8	0.950	24.1	0.760	19.3	0.020 ± 0.004	0.508 ± 0.10
HS1.25FEP1.00	1	1.100	27.9	0.880	22.4	0.020 ± 0.004	0.508 ± 0.10
HS1.25FEP1.25	1 1/4	1.300	33.0	1.000	25.4	0.020 ± 0.004	0.508 ± 0.10
HS1.25FEP1.50	1-1/2	1.700	43.2	1.300	33.0	0.020 ± 0.004	0.508 ± 0.10
HS1.25FEP2.00	2	2.100	53.3	1.700	43.2	0.020 ± 0.004	0.508 ± 0.10
HS1.25FEP2.25	2-1/4	2.260	59.7	2.000	50.8	0.020 ± 0.004	0.508 ± 0.10
HS1.25FEP2.50	2-1/2	2.600	66.0	2.100	53.3	0.020 ± 0.004	0.508 ± 0.10
HS1.25FEP3.00	3	3.100	78.7	2.600	66.0	0.020 ± 0.004	0.508 ± 0.10
HS1.25FEP3.50	3-1/2	3.500	88.9	3.100	78.7	0.020 ± 0.004	0.508 ± 0.10
HS1.25FEP4.00	4	4.300	109.2	3.500	88.9	0.020 ± 0.004	0.508 ± 0.10
HS1.25FEP5.00	5	5.200	132.1	4.300	109.3	0.020 ± 0.004	0.508 ± 0.10
HS1.25FEP6.00	6	6.200	157.5	5.200	132.1	0.020 ± 0.004	0.508 ± 0.10
HS1.25FEP7.00	7	7.200	182.9	6.200	157.5	0.020 ± 0.004	0.508 ± 0.10
HS1.25FEP8.00	8	8.300	210.8	7.200	182.9	0.020 ± 0.004	0.508 ± 0.10



FEP/PTFE Heat Shrinkable Double Shrink Series TSSS and TSSL



Features

- Double Shrink encapsulates your parts as the FEP melts during the PTFE shrinking process
- Protects cables, tubes and other objects from moisture and dirt
- Self extinguishing

Certifications

- VW-1, UL-83 (natural)

Applications/Markets



- Wire splices
- Encapsulates fittings

FEP/PTFE Double Shrink Tubing

Part Number	Minimum Expanded I.D.		Maximum Recovered I.D.		Nominal Recovered Wall	
	inch	mm	inch	mm	inch	mm
Standard Wall						
TSSS036	0.036	0.91	0.00	0.00	0.023	0.584
TSSS060	0.060	1.52	0.00	0.00	0.028	0.711
TSSS130	0.130	3.30	0.00	0.00	0.032	0.813
TSSS160	0.160	4.06	0.00	0.00	0.032	0.813
TSSS190	0.190	4.83	0.061	1.55	0.035	0.889
TSSS250	0.250	6.35	0.125	3.18	0.035	0.889
TSSS350	0.350	8.89	0.190	4.83	0.035	0.889
TSSS450	0.450	11.4	0.312	7.92	0.055	1.400
TSSS700	0.700	17.8	0.440	11.2	0.055	1.400
TSSS950	0.950	24.1	0.680	17.3	0.065	1.650

Light Wall						
TSSL065	0.065	1.65	0.00	0.00	0.015	0.381
TSSL115	0.115	2.92	0.045	1.14	0.015	0.381
TSSL130	0.130	3.30	0.060	1.52	0.015	0.381
TSSL180	0.180	4.57	0.065	1.65	0.015	0.381
TSSL190	0.190	4.83	0.070	1.78	0.015	0.381
TSSL240	0.240	6.10	0.150	3.81	0.020	0.508
TSSL350	0.350	8.89	0.210	5.33	0.025	0.635
TSSL480	0.480	12.2	0.315	8.00	0.032	0.813
TSSL700	0.700	17.8	0.500	12.7	0.040	1.020
TSSL1000	1	25.4	0.700	17.8	0.045	1.140

Order Information

Example: TSSL036-NC48.000

TSSL036-NC48.000 – **Double Shrink**
 TSSL036-NC48.000 – **Light Wall**
 TSSL**036**-NC48.000 – **Size in inches (0.036")**
 TSSL036-NC**48.000** – **Natural**
 TSSL036-NC**48.000** – **Cut Tubing**
 TSSL036-NC**48.000** – **Package Quantity**
 in feet (**48"**)

Notes

- Working Temperature: 450°F (231°C)
- Shrink Temperature: 680°F (360°C)
- Longitudinal Change: +/- 10%
- Heat Shrink tubing is available in stock packaging of 4-ft. straight lengths
- Custom packaging, sizes, lengths and colors are quoted upon request
- Minimum quantities may apply

Colors

- ○ Natural, Translucent

For detailed ordering information, please consult price list or contact Parflex® Division.

Parker Hannifin Corporation | Parflex® Division | Ravenna, Ohio | parker.com/pfd

www.comoso.com



B-89

FEP Convoluted Tubing

Series: CV03 and Convo-Flon™



Features

- Cuffs are sized on the I.D.
- Very flexible
- Long continuous lengths
- Translucent
- Chemically inert
- Good flexlife

Certifications/Compliance

- ASTM D3296-03
- VW-1, UL-83 (natural)

Applications/Markets



- Fluid Transport
- Vascular Graft
- Laboratory
- Robotics

Order Information

Example: CV03-1-1/2-NT

CV03-1-1/2-NT – Convoluted Tubing

CV03-1-1/2-NT – FEP

CV03-1-1/2-NT – Tube Size in inches (1-1/2")

CV03-1-1/2-NT – Natural

Notes

- Working Temperature: -100°F to 400°F (-75°C to 204°C)

Colors

- ○ Natural, Translucent

FEP Convoluted

(Standard tubing is natural)

Part Number	Order Size	Standard Cuff I.D. "A"		Standard Cuff Length "B"		Wall Thickness "C"		Min. Inside Diameter "D"		Max. Inside Diameter "D"		Max. Outside Diameter "E"		**Min. Bend Radius	
		inch	mm	inch	mm	inch	mm	inch	mm	inch	mm	inch	mm	inch	mm
CV03-1/4-NT	1/4	1/4	6.35	3/4	19.1	0.020	0.508	0.251	6.38	0.265	6.73	0.405	10.3	0.365	9
CV03-5/16-NT	5/16	5/16	7.94	1	25.4	0.023	0.584	0.273	6.93	0.281	7.14	0.424	10.8	0.500	13
CV03-3/8-NT	3/8	3/8	9.53	1	25.4	0.023	0.584	0.364	9.25	0.375	9.53	0.530	13.5	0.875	22
CV03-1/2-NT	1/2	1/2	12.7	1	25.4	0.025	0.635	0.485	12.3	0.500	12.7	0.660	16.8	0.625	16
CV03-5/8-NT	5/8	5/8	15.9	1-1/4	31.8	0.025	0.635	0.609	15.5	0.625	15.9	0.780	19.8	1.500	38
CV03-3/4-NT	3/4	3/4	19.1	1-1/2	38.1	0.025	0.635	0.730	18.5	0.750	19.1	0.975	24.8	3.500	89
CV03-1.00-NT	1	1	25.4	2	50.8	0.030	0.762	0.975	24.8	1.000	25.4	1.260	32.0	2.250	57
CV03-1.25-NT	1-1/4	1-1/4	31.8	2-1/2	63.5	0.040	1.02	1.210	30.7	1.250	31.8	1.540	39.1	2.500	64
CV03-1.50-NT	1-1/2	1-1/2	38.1	2-1/2	63.5	0.045	1.14	1.490	37.8	1.530	38.9	1.940	49.2	3.000	76
CV03-2.00-NT	2	2	50.8	2-1/2	63.5	0.045	1.14	1.990	50.5	2.020	51.3	2.370	60.2	4.250	108
CV03-2.50-NT	2-1/2	2-1/2	63.5	3	73.2	0.065	1.65	2.440	61.9	2.500	63.5	3.000	76.2	6.500	165
CV03-3.00-NT	3	3	76.2	3	73.2	0.065	1.65	2.92	74.2	3.02	76.7	3.74	95.0	7.50	191

** Minimum 36" length.

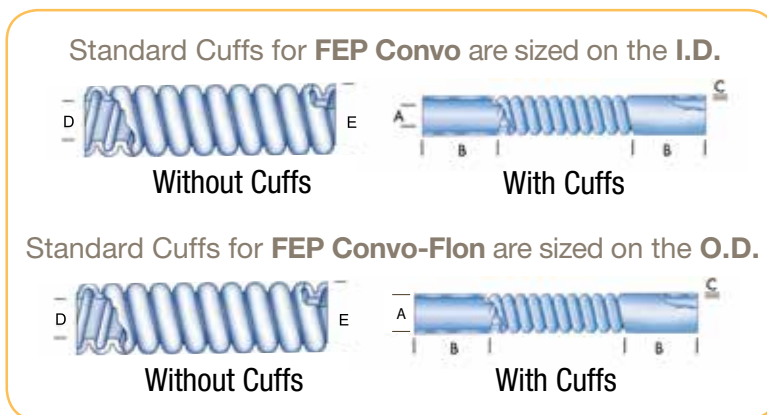

FEP Convo-Flon™ Convoluted

(Standard tubing is natural)

Part Number	Order Size	Standard Cuff O.D. "A"		Standard Cuff Length "E"		Wall Thickness "C"		Min. Inside Diameter "B"		Max. Inside Diameter "B"		Max. Outside Diameter "A"		**Min. Bend Radius	
		inch	mm	inch	mm	inch	mm	inch	mm	inch	mm	inch	mm	inch	mm
Contact Customer Service	1/4 x 3/8	1/4	6.35	3/4	19.1	0.020	0.508	0.251	6.38	0.265	6.73	0.375	9.53	0.625	16
	3/8 x 1/2	5/16	7.94	1	25.4	0.023	0.584	0.364	9.25	0.375	9.53	0.500	12.7	0.875	22
	1/2 x 5/8	3/8	9.53	1	25.4	0.025	0.635	0.480	12.2	0.500	12.7	0.625	15.9	1.250	32
	5/8 x 3/4	1	25.4	2	50.8	0.025	0.635	0.609	15.5	0.625	15.9	0.750	19.1	1.500	38
	3/4 x 7/8	1-1/4	31.8	2-1/2	63.5	0.025	0.635	0.730	18.5	0.750	19.1	0.875	22.2	1.750	44
	.800 x 1	1-1/2	38.1	2-1/2	63.5	0.030	0.762	0.800	20.3	0.820	2.80	1.000	25.4	2.250	57
	1-1/4 1-1/2	Contact Customer Service for actual dimensions.													

** Minimum 36" length.

For detailed ordering information, please consult price list or contact Parflex® Division.

FEP Convoluted

Series SAE AS81914/3 and SAE AS81914/4

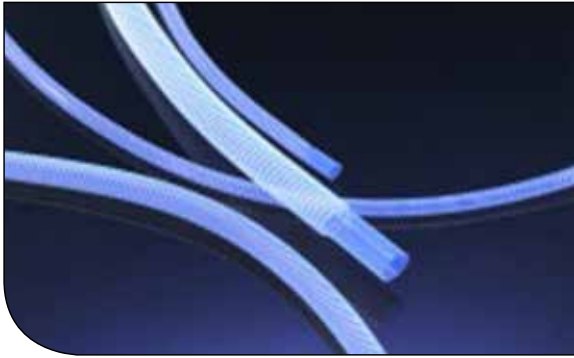

Features

- Longer lengths than PTFE
- Excellent clarity
- Chemically inert
- Low coefficient of friction
- Superior dielectric strength
- Good heat resistance
- Self extinguishing
- Non-wetting

Certifications

- SAE AS81914/3
- SAE AS81914/4
- ASTM D3296-03
- FDA Compliant
- USP Class VI Compliant
- VW-1, UL-83 (natural)

Applications/Markets



- Fluid Handling
- Harnesses
- Lab Equipment
- Robotics

Order Information

Example: 81914/3-1001-NT

81914/3-1001-NT – SAE AS81914 Convoluted

81914/3-1001-NT – **FEP**

81914/3-**1001**-NT – **Helical Convolutions**

81914/3-100**1**-NT – **Size (01=0.187")**

81914/3-1001-**NT** – **Color (N=Natural)**

81914/3-1001-**NT** – "**T**" is bulk (for cut tubing remove "T", add length, ie. 81914/3-1001-N1200 = 187" Convo, natural, cut 12" long)

Notes

- Working Temperature: 392°F (200°C)
- Tubing is provided in natural without cuffs direct from inventory
- Stock packaging is random coils
- Also available in close convolution 81914/4
- Minimum quantities may apply
- Custom packaging, sizes, lengths, cuffs and colors are quoted upon request

Colors

- ○ Natural, Translucent
- Colors available as custom run, see color code table

When ordering convoluted tubing in colors, the "N" designation for natural should be replaced by the correct color designator;

ie 81914/3-1001-0T (black bulk tubing)

ie 81914/3-1001-01200 (black tubing - 12 inches long)

Color Code					
○	N	Natural	●	5	Green
●	0	Black	●	6	Blue
●	1	Brown	●	7	Violet
●	2	Red	●	8	Gray
●	3	Orange	○	9	White
●	4	Yellow			

FEP Convuluted Tubing (SAE AS81914/3)

(Standard tubing is natural)

Part Number	MIL Spec	Maximum Inside Diameter		Minimum Inside Diameter		Maximum Outside Diameter		Maximum Wall Thickness		Minimum Bend Radius		Pitch ±1	Weight	
		inch	mm	inch	mm	inch	mm	inch	mm	inch	mm		lb./100 ft.	kg./100 mtr.
81914/3-1001-NT	-01	0.187	4.75	0.181	4.60	0.320	8.13	0.018	0.457	1/2	13	8	1.5	2.23
81914/3-1002-NT	-02	0.281	7.14	0.273	6.93	0.414	10.5	0.018	0.457	3/4	19	8	1.7	2.53
81914/3-1003-NT	-03	0.312	7.93	0.306	7.77	0.450	11.4	0.018	0.457	3/4	19	8	1.9	2.83
81914/3-1004-NT	-04	0.375	9.53	0.364	9.25	0.510	13.0	0.018	0.457	7/8	22	8	2.2	3.27
81914/3-1005-NT	-05	0.437	11.1	0.427	10.9	0.571	14.5	0.018	0.457	7/8	22	8	3.1	4.61
81914/3-1006-NT	-06	0.500	12.7	0.485	12.3	0.650	16.5	0.023	0.584	1-1/4	32	7	4.0	5.95
81914/3-1007-NT	-07	0.625	15.9	0.608	15.4	0.770	19.6	0.023	0.584	1-1/2	38	7	4.8	7.14
81914/3-1008-NT	-08	0.750	19.1	0.730	18.5	0.930	23.6	0.023	0.584	1-3/4	44	6	6.1	9.07
81914/3-1009-NT	-09	0.875	22.2	0.860	21.8	1.073	27.3	0.023	0.584	2	51	5	7.0	10.4
81914/3-1010-NT	-10	1.000	25.4	0.975	24.8	1.226	31.1	0.023	0.584	2.370	60	5	8.5	12.7
81914/3-1011-NT	-11	1.125	28.6	1.105	28.1	1.390	35.3	0.023	0.584	2.370	60	5	9.3	13.8
81914/3-1012-NT	-12	1.250	31.8	1.210	30.7	1.539	39.1	0.023	0.584	2-3/4	70	4	10.9	16.2
81914/3-1013-NT	-13	1.500	38.1	1.437	36.5	1.832	46.5	0.023	0.584	3.380	86	4	12.6	18.8
81914/3-1014-NT	-14	1.750	44.5	1.688	42.9	2.082	52.9	0.023	0.584	3.880	98	4	14.8	22.0
81914/3-1015-NT	-15	2.000	50.8	1.937	49.2	2.332	59.2	0.023	0.584	4.250	108	4	16.8	25.0

FEP convuluted tubing is provided in NATURAL without cuffs direct from the factory. Natural part numbers are designated with "NT" after the Mil Spec number (ie 81914/3-1014-NT).

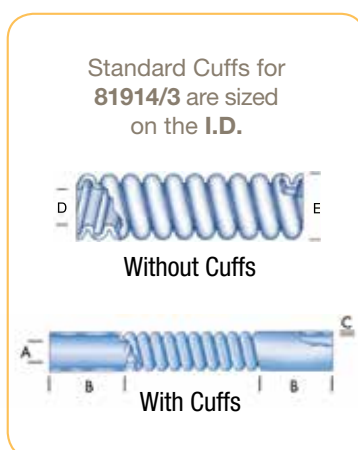

For detailed ordering information, please consult price list or contact Parflex® Division.

Parker Hannifin Corporation | Parflex® Division | Ravenna, Ohio | parker.com/pfd

www.comoso.com



B-93

FEP/PFA Corrugated

Extra Flexible Fluoropolymer Tubing, Series CR03



Features

- Capable of turning sharp corners without reducing the inside diameter of the tube
- Extremely flexible
- Kink resistant
- Non stick surface allows for easy cleaning
- Excellent clarity
- Chemically inert
- Available in FEP, PFA and High Purity PFA

Certifications

- FEP - ASTM D3296-03
- PFA - ASTM D3307-10
- FDA Compliant
- USP Class VI Compliant
- VW-1, UL-83 (natural)

Applications/Markets



- Vacuum Applications
- Robotics
- Instrumentation
- DNA Sequencer
- Fluid Transfer
- Pharmaceutical
- Wet Bench

Order Information

Example: CR03-3/4-NT

CR03-3/4-NT – Corrugated Tubing

CR03-3/4-NT – FEP

CR03-3/4-NT – Tube I.D. when cuffed in inches (3/4")

CR03-3/4-NT – Color (N=Natural)

CR03-3/4-NT – "T" is bulk - for cuffed tubing add length, ie. CR03-3/4-N1200 = 1" Corr, natural, cut 12" long

Colors

- ○ Natural, Translucent

Notes

- Working Temperature: 200°F (93°C) @ 0 pressure - For higher temperatures, request PFA Corrugated 300°F (148°C) @ 0 pressure
- Vacuum Service: 29.9 IN. Hg (759M Hg)
- Extension-Compression Length Ratio: Approximately 2:1
- Tubing is provided in natural without cuffs direct from inventory or with cuffs, as requested at time of order
- Stock packaging is random coils
- Minimum quantities may apply
- Corrugated tubing is also available in specialty configurations where corrugated and straight tubing run intermittently along the tube
- Custom packaging, sizes, lengths and colors are quoted upon request

FEP Tex-Flex™ Corrugated

Part Number	Size To Order	Maximum Cuff I.D. "A"		Standard Cuff Length "B"		Wall Thickness "C"		Ref. Outside Diameter "D"		Corrugated Length "E"	Minimum Bend Radius	
		inch	mm	inch	mm	inch	mm	inch	mm		±1	inch
CR03-1/4-NT	1/4	0.250	6.35	3/4	19.1	0.015	0.38	0.375	9.53	To be specified at time of order	0.125	3.18
CR03-3/8-NT	3/8	0.375	9.53	1	25.4	0.020	0.51	0.625	15.9		0.187	4.76
CR03-1/2-NT	1/2	0.500	12.7	1	25.4	0.025	0.64	0.750	19.0		0.250	6.35
CR03-5/8-NT	5/8	0.625	15.9	1	25.4	0.025	0.64	0.938	23.8		0.312	7.94
CR03-3/4-NT	3/4	0.750	19.1	1-1/2	38.1	0.030	0.76	1.063	26.9		0.375	9.53
CR03-7/8-NT	7/8	0.875	22.2	1-1/2	38.1	0.030	0.76	1.250	31.8		0.438	11.1
CR03-1.00-NT	1	1.000	24.8	2	50.8	0.035	0.89	1.438	36.5		0.500	12.7
CR03-1.25-NT	1-1/4	1.250	31.8	2	50.8	0.035	0.89	1.625	41.3		0.625	15.9
CR03-1.50-NT	1-1/2	1.500	38.1	2	50.8	0.035	0.89	1.813	46.1		0.750	19.1
CR03-2.00-NT	2	2.000	50.8	2	50.8	0.040	1.02	2.625	66.7		1.000	25.4
CR03-2.50-NT	2-1/2	2.5000	63.8	2-1/2	63.5	0.070	1.78	3.360	85.3		2.500	63.5

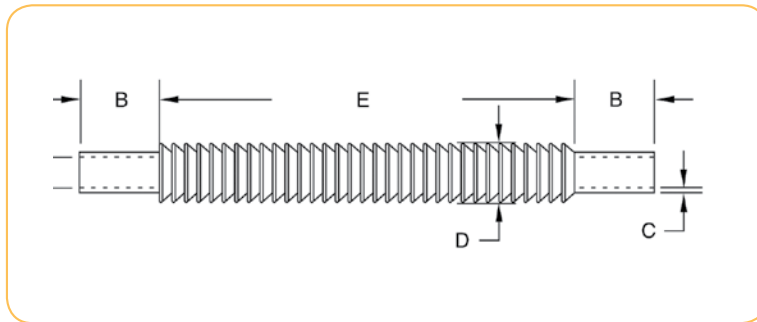

For detailed ordering information, please consult price list or contact Parflex® Division.

Parker Hannifin Corporation | Parflex® Division | Ravenna, Ohio | parker.com/pfd

www.comoso.com



B-95

A Hose

B Tubing
Fluoropolymer

C Coiled Air Hose
& Fittings

D Transportation

E Fittings

F Tooling, Equipment
& Accessories

G General Technical

Retractable Coiled Tubing

Single or Dual Containment, Series 703, 704, 705

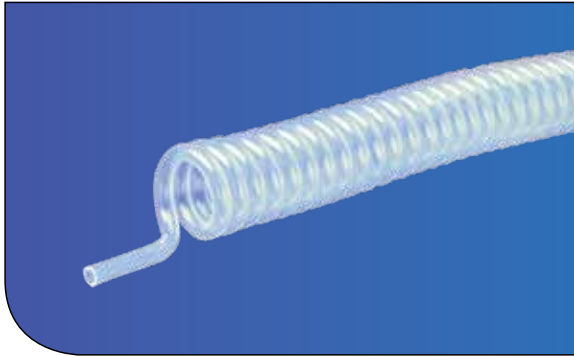

Features

- Extremely flexible
- Excellent clarity
- Chemically inert
- Low coefficient of friction
- Self extinguishing
- Non-wetting
- Available in FEP, PFA and High Purity PFA

Certifications

- FEP - ASTM D3296-03
- PFA - ASTM D3307-10
- FDA Compliant
- USP Class VI Compliant
- VW-1, UL-83 (natural)

Applications/Markets



- Fluid Handling
- Wet Bench
- Lab Equipment
- Gas Dispensing
- Medical

Order Information

Example: 704-0312062-xx0012

704-0312062-xx0012 – **Retractable tubing**

704-0312062-xx0012 – **PFA**

704-0312062-xx0012 – **Tube O.D. in inches (3/16")**

704-0312062-xx0012 – **Wall (0.062")**

704-0312062-xx0012 – **Custom Options** (when needed)

704-0312062-xx0012 – **Length 12"**

Fittings

Fittings available for sizes 3/16" up to 1/2"

Parker Fittings available from:
Fluid System Connectors Division
Otsego, MI

(269) 694-2550

(269) 692-6634 FAX

FSC Product Families:

- Compression
- Compress-Align®
- TrueSeal™

Colors

- ○ Natural, Translucent

Notes

- Working Temperature: 200°F (93°C) @ 0 pressure - For higher temperatures, request PFA 300°F (148°C) @ 0 pressure; above these temperatures, the coils dimensions are not stable and the coils will lose their shape
- "X" denotes resin type - Replace "X" with 3 for FEP, 4 for PFA and 5 for HP PFA
- "xx" denotes custom options - Use when needed
- Standard left/right tail length is 6 inches
- Minimum quantities may apply
- Custom packaging, sizes, lengths and colors are quoted upon request

Retractable Tubing

Part Number	Size To Order O.D. x Wall	Coil Inside Diameter		Retracted Length "A"		Extended Length	
		inch	mm	inch	mm	inch	mm
70X-0188062-xx0003	3/16" x 1/16"	0.750	19.1	3	76	12	305
70X-0188062-xx0006	3/16" x 1/16"	0.750	19.1	6	152	24	610
70X-0188062-xx0012	3/16" x 1/16"	0.750	19.1	12	305	48	1219
70X-0188062-xx0018	3/16" x 1/16"	0.750	19.1	18	457	72	1829
70X-0250062-xx0003	1/4" x 1/8"	1	25.4	3	76	12	305
70X-0250062-xx0006	1/4" x 1/8"	1	25.4	6	152	24	610
70X-0250062-xx0012	1/4" x 1/8"	1	25.4	12	305	48	1219
70X-0250062-xx0018	1/4" x 1/8"	1	25.4	18	457	72	1829
70X-0312062-xx0003	5/16" x 3/16"	1.625	41.3	3	76	12	305
70X-0312062-xx0006	5/16" x 3/16"	1.625	41.3	6	152	24	610
70X-0312062-xx0012	5/16" x 3/16"	1.625	41.3	12	305	48	1219
70X-0312062-xx0018	5/16" x 3/16"	1.625	41.3	18	457	72	1829
70X-0375062-xx0003	3/8" x 1/4"	1.625	41.3	3	76	12	305
70X-0375062-xx0006	3/8" x 1/4"	1.625	41.3	6	152	24	610
70X-0375062-xx0012	3/8" x 1/4"	1.625	41.3	12	305	48	1219
70X-0375062-xx0018	3/8" x 1/4"	1.625	41.3	18	457	72	1829
70X-0438062-xx0003	7/16" x 5/16"	3	76.2	3	76	12	305
70X-0438062-xx0006	7/16" x 5/16"	3	76.2	6	152	24	610
70X-0438062-xx0012	7/16" x 5/16"	3	76.2	12	305	48	1219
70X-0500062-xx0003	1/2" x 3/8"	3	76.2	3	76	12	305
70X-0500062-xx0006	1/2" x 3/8"	3	76.2	6	152	24	610
70X-0500062-xx0012	1/2" x 3/8"	3	76.2	12	305	48	1219

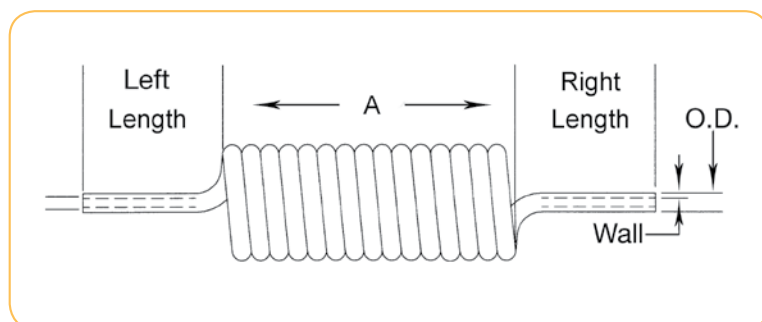

For detailed ordering information, please consult price list or contact Parflex® Division.

Parker Hannifin Corporation | Parflex® Division | Ravenna, Ohio | parker.com/pfd

www.comoso.com



B-97

A
Hose

B
Tubing
Fluoropolymer

C
Coiled Air Hose
& Fittings

D
Transportation

E
Fittings

F
Tooling, Equipment
& Accessories

G
General Technical

PFA Tubing

Series Fractional & Metric: 104, 204



Features

- Virgin Perfluoroalkoxy
- Translucent
- High purity resins available
- Low permeability
- Exceptional heat resistance
- Chemically inert
- Long continuous lengths
- Low coefficient of friction
- Self extinguishing
- Non-wetting
- Non leaching

Certifications/Compliance

- ASTM D3307-10
- VW-1, UL-83 (natural)
- FDA Compliant
- USP Class VI Compliant

Applications/Markets



- Air Sampling
- Gas Sampling
- Fluid Transfer
- Laboratory
- Wet Bench
- Flow Monitoring
- Steam Plant

Order Information

Example: 104-0188062-N-100

104-0188062-N-100 – **Fractional**

104-0188062-N-100 – **PFA**

104-0188062-N-100 – **Tube O.D.** in inches (**3/16"**)

104-0188062-N-100 – **Tube Wall Thickness** in inches (**.062"**)

104-0188062-N-100 – **Natural**

104-0188062-N-100 – **Package Quantity** in feet (**100'**)

Fittings

Fittings available for sizes 3/32" up to 1"

Parker Fittings available from:
Fluid System Connectors Division
Otsego, MI

(269) 694-2550

(269) 692-6634 FAX

FSC Product Families:

- Compression
- Compress-Align®
- TrueSeal™

Notes

- Working Temperature:
-100°F to 500°F (-75°C to 260°C)
- Working pressure calculated using a Design Factor of 4 at 73°F (23°C)
- Custom packaging and sizes are quoted upon request
- Package quantities are not continuous

Options

- Smoothbore
- Convoluted
- Corrugated
- Retractable Coils
- Heat Shrink

Colors

- ○ Natural, Translucent
- Colors available as custom run, see color code table

Color Code					
○	N	Natural	●	5	Green
●	0	Black	●	6	Blue
●	1	Brown	●	7	Violet
●	2	Red	●	8	Gray
●	3	Orange	○	9	White
●	4	Yellow			

104 PFA Industrial Wall Fractional Size Tubing

Part Number	Order Size	Nominal O.D.				Nominal I.D.				Reference Wall		Working Pressure		Burst Pressure		Min. Bend Radius		Vac. Rating	Weight	
		inch	mm	tol.	mm	inch	mm	tol.	mm	inch	mm	psi 73°F	bar 23°C	psi 73°F	bar 23°C	inch	mm		at 73°F	lb. per ft.
#																				
104-0094031	3/32	0.094	±0.004	2.40	±0.102	0.031	±0.002	0.79	±0.051	0.031	0.79	680	47	2720	188	0.250	6	28	0.006	0.009
104-0125031	1/8	0.125	±0.004	3.18	±0.102	0.064	±0.004	1.63	±0.102	0.031	0.79	500	34	2000	138	0.375	10	28	0.009	0.013
104-0156031	5/32	0.157	±0.005	3.99	±0.127	0.094	±0.003	2.39	±0.076	0.031	0.79	390	27	1560	108	0.625	16	28	0.011	0.017
104-0188031	3/16	0.188	±0.005	4.78	±0.127	0.125	±0.005	3.18	±0.127	0.031	0.79	320	22	1280	88	0.625	16	28	0.014	0.021
104-0250031	1/4	0.250	±0.005	6.35	±0.127	0.188	±0.005	4.78	±0.127	0.031	0.79	230	16	920	63	0.875	22	28	0.020	0.030
104-0312031	5/16	0.312	±0.005	7.92	±0.127	0.250	±0.005	6.35	±0.127	0.031	0.79	180	12	720	50	1.750	44	28	0.025	0.038
104-0375031	3/8	0.375	±0.005	9.52	±0.127	0.312	±0.005	7.92	±0.127	0.031	0.79	140	10	560	39	3.250	83	28	0.031	0.047
104-0438031	7/16	0.438	±0.005	11.13	±0.127	0.375	±0.005	9.53	±0.127	0.031	0.79	120	8	480	33	3.250	83	28	0.037	0.055
104-0500031	1/2	0.500	±0.005	12.70	±0.127	0.438	±0.005	11.13	±0.127	0.031	0.79	100	7	400	28	4.750	121	28	0.043	0.063
104-0563031	9/16	0.563	±0.006	14.30	±0.152	0.500	±0.006	12.70	±0.152	0.031	0.79	80	6	320	22	5.000	127	28	0.048	0.072

104 PFA Heavy Wall Fractional Size Tubing

Part Number	Order Size	Nominal O.D.				Nominal I.D.				Reference Wall		Working Pressure		Burst Pressure		Min. Bend Radius		Vac. Rating	Weight	
		inch	mm	tol.	mm	inch	mm	tol.	mm	inch	mm	psi 73°F	bar 23°C	psi 73°F	bar 23°C	inch	mm		at 73°F	lb. per ft.
#																				
104-0188062	3/16	0.188	±0.005	4.78	±0.127	0.062	±0.005	1.57	±0.127	0.062	1.57	680	47	2720	188	0.500	13	28	0.023	0.034
104-0250040	1/4	0.250	±0.005	6.35	±0.127	0.170	±0.005	4.32	±0.127	0.040	1.02	300	21	1200	83	0.875	22	28	0.025	0.037
104-0250047	1/4	0.250	±0.005	6.35	±0.127	0.156	±0.005	3.96	±0.127	0.047	1.19	370	26	1480	102	1.000	25	28	0.028	0.042
104-0250062	1/4	0.250	±0.005	6.35	±0.127	0.125	±0.005	3.18	±0.127	0.062	1.57	500	34	2000	138	0.500	13	28	0.034	0.051
104-0312062	5/16	0.312	±0.005	7.92	±0.127	0.188	±0.005	4.78	±0.127	0.062	1.57	390	27	1560	108	0.750	19	28	0.045	0.068
104-0375062	3/8	0.375	±0.005	9.52	±0.127	0.250	±0.005	6.35	±0.127	0.062	1.57	320	22	1280	88	1.250	32	28	0.057	0.085
104-0438062	7/16	0.438	±0.005	11.13	±0.127	0.312	±0.005	7.92	±0.127	0.062	1.57	270	19	1080	74	2.625	67	28	0.068	0.102
104-0500062	1/2	0.500	±0.005	12.70	±0.127	0.375	±0.005	9.53	±0.127	0.062	1.57	230	16	920	63	3.000	76	28	0.079	0.119
104-0750062	3/4	0.750	±0.006	19.05	±0.152	0.625	±0.006	15.88	±0.152	0.062	1.57	140	10	560	39	6.000	152	28	0.125	0.186
104-1000062	1	1.000	±0.010	25.40	±0.254	0.875	±0.010	22.22	±0.254	0.062	1.57	100	7	400	28	8.000	203	28	0.170	0.254

204 Metric PFA Tubing

Part Number	Order Size	Nominal O.D.				Nominal I.D.				Reference Wall		Working Pressure		Burst Pressure		Min. Bend Radius		Vac. Rating	Weight	
		mm	mm	tol.	inch	mm	mm	tol.	inch	mm	mm	bar 23°C	psi 73°F	bar 23°C	psi 73°F	mm	inch		at 73°F	kg. per m.
#																				
204-0400100	4	4	±0.11	.157	±0.004	2	±0.11	.079	±0.250	1	0.039	34	500	138	2000	6	0.250	28	0.020	0.014
204-0600100	6	6	±0.11	.236	±0.004	4	±0.11	.157	±0.004	1	0.039	22	320	88	1280	25	1.000	28	0.034	0.023
204-0800100	8	8	±0.11	.315	±0.004	6	±0.11	.236	±0.004	1	0.039	16	230	63	920	51	2.000	28	0.047	0.032
204-1000100	10	10	±0.11	.393	±0.004	8	±0.11	.315	±0.004	1	0.039	12	180	50	720	70	2.750	28	0.061	0.041
204-1200100	12	12	±0.15	.472	±0.006	10	±0.15	.393	±0.006	1	0.039	10	140	39	560	89	3.500	28	0.074	0.050

For detailed ordering information, please consult price list or contact Parflex® Division.

Parker Hannifin Corporation | Parflex® Division | Ravenna, Ohio | parker.com/pfd

www.comoso.com



B-99

A Hose

B Tubing Fluoropolymer

C Coiled Air Hose & Fittings

D Transportation

E Fittings

F Tooling, Equipment & Accessories

G General Technical

High Purity PFA Tubing

Series Fractional & Metric: 105, 205



Features

- Withstands corrosive surfactants for longer periods of time
- Highest molecular weight available
- Lowest level of extractables
- Low permeability
- Exceptional heat resistance
- Chemically inert
- Long continuous lengths
- Low coefficient of friction
- Self extinguishing
- Non leaching

Certifications/Compliance

- ASTM D3307-10
- VW-1, UL-83 (natural)
- FDA Compliant
- USP Class VI Compliant

Applications/Markets



- Flow Monitoring
- Gas Transfer
- Food
- Wet Bench
- DI Water Dispensers
- DI Recirculators
- Heat Exchangers
- Pure Chemical Dispensers
- High Purity Applications

Order Information

Example: 105-0375031-N-100

105-0375031-N-100 – **Fractional**

105-0375031-N-100 – **High Purity PFA**

105-**0375031**-N-100 – **Tube O.D.** in millimeters (**3/8"**)

105-0375**031**-N-100 – **Tube Wall Thickness** in millimeters (**.031"**)

105-0375031-**N**-100 – **Natural**

105-0375031-N-**100** – **Package Quantity** in feet (**100'**)

Fittings

Fittings available for sizes 4mm up to 12mm

Parker Fittings available from:
Fluid System Connectors Division
Otsego, MI

(269) 694-2550

(269) 692-6634 FAX

FSC Product Families:

- Compression
- Compress-Align®
- TrueSeal™

Notes

- Working Temperature:
-100°F to 500°F (-75°C to 260°C)
- Working pressure calculated using a Design Factor of 4 at 73°F (23°C)
- Custom packaging and sizes are quoted upon request
- Package quantities are not continuous

Options

- Smoothbore
- Convoluted
- Corrugated
- Retractable Coils

Colors

- Natural, Translucent

105 High Purity PFA Industrial Wall Fractional Size Tubing

Part Number	Order Size	Nominal O.D.				Nominal I.D.				Reference Wall		Working Pressure		Burst Pressure		Min. Bend Radius		Vac. Rating	Weight	
		inch	inch	tol.	mm	tol.	inch	tol.	mm	tol.	inch	mm	psi 73°F	bar 23°C	psi 73°F	bar 23°C	inch		mm	at 73°F
#																				
105-0125031	1/8	0.125	± 0.004	3.18	± 0.102	0.064	± 0.004	1.63	± 0.102	0.031	0.79	500	34	2000	138	0.500	13	28	0.009	0.013
105-0188031	3/16	0.188	± 0.005	4.78	± 0.127	0.125	± 0.005	3.18	± 0.127	0.031	0.79	320	22	1280	88	0.750	19	28	0.014	0.021
105-0250031	1/4	0.250	± 0.005	6.35	± 0.127	0.188	± 0.005	4.78	± 0.127	0.031	0.79	230	16	920	63	1.000	25	28	0.020	0.030
105-0375031	3/8	0.375	± 0.005	9.52	± 0.127	0.312	± 0.005	7.92	± 0.127	0.031	0.79	140	10	560	39	3.500	89	28	0.031	0.047

105 High Purity PFA Heavy Wall Fractional Size Tubing

Part Number	Order Size	Nominal O.D.				Nominal I.D.				Reference Wall		Working Pressure		Burst Pressure		Min. Bend Radius		Vac. Rating	Weight	
		inch	inch	tol.	mm	tol.	inch	tol.	mm	tol.	inch	mm	psi 73°F	bar 23°C	psi 73°F	bar 23°C	inch		mm	at 73°F
#																				
105-0250040	1/4	0.250	± 0.005	6.35	± 0.127	0.170	± 0.005	4.32	± 0.127	0.040	1.02	300	21	1200	83	0.938	24	28	0.025	0.037
105-0250047	1/4	0.250	± 0.005	6.35	± 0.127	0.156	± 0.005	3.96	± 0.127	0.047	1.19	370	26	1480	102	0.500	13	28	0.028	0.042
105-0250062	1/4	0.250	± 0.005	6.35	± 0.127	0.125	± 0.005	3.18	± 0.127	0.062	1.57	500	34	2000	138	0.625	16	28	0.034	0.051
105-0375062	3/8	0.375	± 0.005	9.52	± 0.127	0.250	± 0.005	6.35	± 0.127	0.062	1.57	320	22	1280	88	1.125	29	28	0.057	0.085
105-0500062	1/2	0.500	± 0.005	12.70	± 0.127	0.375	± 0.005	9.53	± 0.127	0.062	1.57	230	16	920	63	2.250	57	28	0.079	0.119
105-0750062	3/4	0.750	± 0.006	19.05	± 0.152	0.625	± 0.006	15.88	± 0.152	0.062	1.57	140	10	560	39	4.250	108	28	0.125	0.186
105-1000062	1	1.000	± 0.010	25.40	± 0.254	0.875	± 0.010	22.22	± 0.254	0.062	1.57	100	7	400	28	8.000	203	*	0.170	0.254

205 Metric High PFA Tubing

Part Number	Order Size	Nominal O.D.				Nominal I.D.				Reference Wall		Working Pressure		Burst Pressure		Min. Bend Radius		Vac. Rating	Weight	
		mm	mm	tol.	inch	tol.	mm	tol.	inch	tol.	mm	inch	bar 23°C	psi 73°F	bar 23°C	psi 73°F	mm		inch	at 73°F
#																				
205-0300100	3	3	± 0.11	0.118	± 0.004	1	± 0.11	0.039	± 0.004	1	0.039	47	680	188	2720	13	0.500	28	0.014	0.009
205-0400100	4	4	± 0.11	0.157	± 0.004	2	± 0.11	0.079	± 0.004	1	0.039	34	500	138	2000	13	0.500	28	0.020	0.020
205-0600100	6	6	± 0.11	0.236	± 0.004	4	± 0.11	0.157	± 0.004	1	0.039	22	320	88	1280	22	0.875	28	0.034	0.023
205-0800100	8	8	± 0.11	0.315	± 0.004	6	± 0.11	0.236	± 0.004	1	0.039	16	230	63	920	35	1.375	28	0.047	0.032
205-1000100	10	10	± 0.11	0.393	± 0.004	8	± 0.11	0.315	± 0.004	1	0.039	12	180	50	720	51	2.000	28	0.061	0.041
205-1200100	12	12	± 0.15	0.472	± 0.006	10	± 0.15	0.394	± 0.006	1	0.039	10	140	39	560	89	3.500	28	0.074	0.050

For detailed ordering information, please consult price list or contact Parflex® Division.

Parker Hannifin Corporation | Parflex® Division | Ravenna, Ohio | parker.com/pfd

www.comoso.com



PVDF Tubing Polyvinylidene Fluoride

Series PVDF Flex: 110, Series PVDF Super-Flex®: 111



Features

- Low extractable levels
- High mechanical strength
- Good chemical resistance
- High abrasion resistance
- Exceptional thermal stability
- Low permeability
- Self extinguishing
- Weather resistant

Certifications

- ASTM D3222
- FDA Compliant

Applications/Markets



- Applications with long cycle life
- Gas
- Food
- Thermal cycling
- Outdoor/extreme conditions
- Water systems
- Ground water monitoring
- Fluid and handling

Order Information

Example: 110-0312062-NT-100

110-0312062-NT-100 – **PVDF Flex**

110-0312062-NT-100 – **Tube O.D.** in inches (5/16")

110-0312062-NT-100 – **Tube Wall Thickness** in inches (.062")

110-0312062-NT-100 – **Natural**

110-0312062-NT-100 – **Bulk Tubing**

110-0312062-NT-100 – **Package Quantity** in feet (100')

Notes

- Working Temperature: -80°F to 265°F (-62°C to 130°C)
- Working pressure calculated using a Design Factor of 4 at 73°F (23°C)
- Custom packaging and sizes are quoted upon request

Colors

- ○ Off-white

Fittings

Fittings available for sizes 1/8" up to 1"

Parker Fittings available from:
Fluid System Connectors Division
Otsego, MI

(269) 694-2550

(269) 692-6634 FAX

FSC Product Families:

- Compression
- Compress-Align®
- TrueSeal™

Color Code

○	N	Natural	●	5	Green
●	0	Black	●	6	Blue
●	1	Brown	●	7	Violet
●	2	Red	●	8	Gray
●	3	Orange	○	9	White
●	4	Yellow			

110 PVDF Flex™ Industrial Wall Fractional Size Tubing

Part Number	Order Size	Nominal O.D.				Nominal I.D.				Reference Wall		Working Pressure		Burst Pressure		Min. Bend Radius		Vac. Rating	Weight	
		inch	inch	tol.	mm	tol.	inch	tol.	mm	tol.	inch	mm	psi 73°F	bar 23°C	psi 73°F	bar 23°C	inch		mm	at 73°F
#																				
110-0125031	1/8	0.125	±0.005	3.18	±0.13	0.062	±0.005	1.57	±0.13	0.031	0.79	267	18.4	1068	73.6	0.500	13	28	0.007	0.011
110-0188031	3/16	0.188	±0.005	4.78	±0.13	0.125	±0.005	3.18	±0.13	0.031	0.79	180	12.4	720	49.6	0.750	19	28	0.012	0.018
110-0250031	1/4	0.250	±0.005	6.35	±0.13	0.188	±0.005	4.78	±0.13	0.031	0.79	170	11.7	680	46.8	1.000	25	28	0.016	0.025
110-0375031	3/8	0.375	±0.005	9.52	±0.13	0.312	±0.005	7.92	±0.13	0.031	0.79	93	6.4	372	25.6	2.500	64	28	0.026	0.039
110-0500031	1/2	0.500	±0.005	12.70	±0.13	0.438	±0.005	11.13	±0.13	0.031	0.79	83	5.7	332	22.9	4.000	102	28	0.035	0.053

110 PVDF Flex™ Heavy Wall Fractional Size Tubing

Part Number	Order Size	Nominal O.D.				Nominal I.D.				Reference Wall		Working Pressure		Burst Pressure		Min. Bend Radius		Vac. Rating	Weight	
		inch	inch	tol.	mm	tol.	inch	tol.	mm	tol.	inch	mm	psi 73°F	bar 23°C	psi 73°F	bar 23°C	inch		mm	at 73°F
#																				
110-0250047	1/4	0.250	±0.005	6.35	±0.13	0.156	±0.005	3.96	±0.13	.047	1.19	208	14.3	832	57.4	0.750	19	28	0.023	0.034
110-0250062	1/4	0.250	±0.005	6.35	±0.13	0.125	±0.005	3.18	±0.13	.062	1.57	330	22.8	1320	91.0	0.500	13	28	0.028	0.042
110-0312062	5/16	0.312	±0.005	7.92	±0.13	0.188	±0.005	4.78	±0.13	.062	1.57	219	15.1	876	60.4	0.875	22	28	0.038	0.056
110-0375062	3/8	0.375	±0.005	9.52	±0.13	0.250	±0.005	6.35	±0.13	.062	1.57	224	15.4	896	61.8	1.000	25	28	0.047	0.070
110-0500062	1/2	0.500	±0.005	12.70	±0.13	0.370	±0.005	9.40	±0.13	.062	1.57	169	11.7	676	46.6	2.000	51	28	0.066	0.098
110-0625062	5/8	0.625	±0.005	15.88	±0.13	0.500	±0.005	12.70	±0.13	.062	1.57	136	9.3	544	37.5	3.000	76	28	0.085	0.126
110-0750062	3/4	0.750	±0.006	19.05	±0.15	0.625	±0.006	15.88	±0.15	.062	1.57	114	7.9	456	31.4	6.000	152	28	0.103	0.154
110-1000062	1	1.000	±0.010	25.40	±0.25	0.875	±0.008	22.22	±0.25	.062	1.57	86	5.9	344	23.7	8.000	203	28	0.141	0.210

111 PVDF Super-Flex® Industrial Wall Fractional Size Tubing

Part Number	Order Size	Nominal O.D.				Nominal I.D.				Reference Wall		Working Pressure		Burst Pressure		Min. Bend Radius		Vac. Rating	Weight	
		inch	inch	tol.	mm	tol.	inch	tol.	mm	tol.	inch	mm	psi 73°F	bar 23°C	psi 73°F	bar 23°C	inch		mm	at 73°F
#																				
111-0188031	3/16	0.188	±0.005	4.78	±0.13	0.125	±0.005	3.18	±0.13	0.031	0.79	180	12.4	720	50	0.750	19	28	0.012	0.018
111-0250031	1/4	0.250	±0.005	6.35	±0.13	0.188	±0.005	4.78	±0.13	0.031	0.79	170	11.7	680	47	0.750	19	28	0.016	0.025
111-0375031	3/8	0.375	±0.005	9.53	±0.13	0.312	±0.005	7.92	±0.13	0.031	0.79	93	6.4	372	26	2.500	64	28	0.026	0.039

111 PVDF Super-Flex® Heavy Wall Fractional Size Tubing

Part Number	Order Size	Nominal O.D.				Nominal I.D.				Reference Wall		Working Pressure		Burst Pressure		Min. Bend Radius		Vac. Rating	Weight	
		inch	inch	tol.	mm	tol.	inch	tol.	mm	tol.	inch	mm	psi 73°F	bar 23°C	psi 73°F	bar 23°C	inch		mm	at 73°F
#																				
111-0250062	1/4	0.250	±0.005	6.35	±0.13	0.125	±0.005	3.18	±0.13	0.062	1.57	330	22.8	1320	91	0.375	10	28	0.028	0.042
111-0375062	3/8	0.375	±0.005	9.52	±0.13	0.250	±0.005	6.35	±0.13	0.062	1.57	224	15.4	896	62	0.750	19	28	0.038	0.056
111-0500062	1/2	0.500	±0.005	12.7	±0.13	0.375	±0.005	9.52	±0.13	0.062	1.57	169	11.7	676	47	1.500	38	28	0.066	0.098

For detailed ordering information, please consult price list or contact Parflex® Division.



Notes



For detailed ordering information, please consult price list or contact Parflex® Division.

Coiled Air Hose and Fittings

Fast-Stor®

NoMar™ Fast-Stor®

Ultra-Lite Superbraid



Table of Contents

Hose & Tubing

Introduction	C-4
Fast-Stor® Air Hose	C-8 : C-9
Fast-Stor® Air Hose Assemblies, A0	C-8
Bulk Air Hose, FS	C-9
NoMar™ Fast-Stor® Urethane Coiled Assemblies, AUFS	C-14
NoMar™ Fast-Stor® High Durometer Urethane Coiled Assemblies, AHUFS	C-17
NoMar™ Fast-Stor® Coils, UFS	C-16
Ultra-Lite Superbraid Hose	C-20

Fittings

Fast-Stor® Fittings	C-10 : C-12
Fast-Stor® Replacement Parts	C-12 : C-13
NoMar™ Fast-Stor® Fittings	C-18







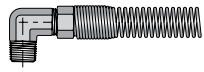

Technical

Assembly Instructions NoMar™ Fast-Stor® Fittings	C-19
Assembly Instructions Fast-Stor® Hose	C-13
Measuring Fast-Stor® Bulk Hose	C-6
Size Selection Procedure	C-5

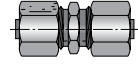

Coiled Air Hose Visual Index



Fast-Stor® Fittings & Replacement Parts	MC Male Connector	ME Male Elbow	ML Live Male Pipe Swivel
	 C-10	 C-10	 C-11
	FC Female Connector	FL Female Pipe Swivel	UC Union Connector
	 C-11	 C-11	 C-12
	FN Brass Nut	FR Plastic Ferrule	SG Steel Spring Guard
	 C-12	 C-12	 C-13
	TS Tube Support		
	 C-13		

NoMar™ Fast-Stor® Assemblies & Coils	AUFS Assemblies	UFS Coils
	 C-14	 C-16

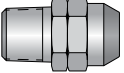
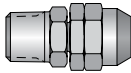
NoMar™ Fast-Stor® Fittings	MCB Male Pipe Rigid	MLB Male Pipe Swivel
	 C-18	 C-19

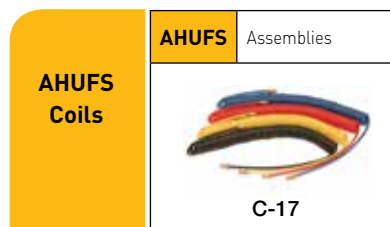

For detailed ordering information, please consult price list or contact Parflex® Division.

Parker Hannifin Corporation | Parflex® Division | Ravenna, Ohio | parker.com/pfd

www.comoso.com



Air Hose

Every hydraulic, pneumatic and lubrication system requires some form of tube line fabrication and fitting installation for completion. Proper fabrication and installation are essential for the overall efficiency, leak free performance, and general appearance of any system.

Start by planning ahead. After sizing the tube lines and selecting the appropriate style of fitting, consider the following in the design of your system:

- Accessibility of joints
- Proper routing of lines
- Adequate tube line supports
- Available fabricating tools

Routing of Lines

Routing of lines is probably the most difficult, yet most significant, of these system design considerations. Proper routing involves getting a connecting line from one point to another through the most logical path.

Always try to leave fitting joints as accessible as possible. Hard to reach joints are hard to assemble and tighten properly. Inaccessible joints are also more difficult and time consuming to service.



Size Selection Procedure

Proper size selection is extremely important in choosing any air hose in order to prevent “starvation” of the air tool and to ensure maximum torque and tool speed. Starved tools don’t produce!

Steps in size selection:

1. Determine air flow rate and pressure required by following air-tool manufacturers recommendations.
2. Refer to “Air Flow Characteristics” graphs, shown below. Find air flow requirement in standard cubic feet per minute (SCFM) on vertical line to left of graph. Now follow horizontal line on same graph to determine total extended length of hose required. Follow vertical line above hose length to intersection with the horizontal air flow SCFM line.
3. Note pressure drop above curve nearest to intersection of SCFM and hose length lines. Pressure drop, subtracted from line pressure, equals “available pressure” at the selected SCFM flow rate and hose length.
4. If “available pressure” is below the tool manufacturers’ recommendations, refer to chart for successively larger hose sizes until an acceptable “available pressure” is found. Choose this size Fast-Stor® Air Hose for your application.
5. Refer to “working pressure vs. temperature” chart (pg. B-9) to be sure your application falls within the working range of Fast-Stor® Air Hose.

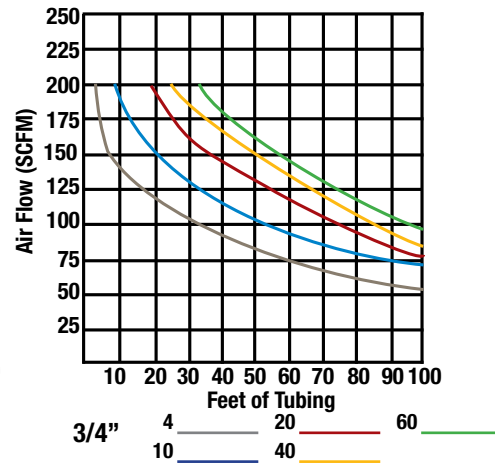
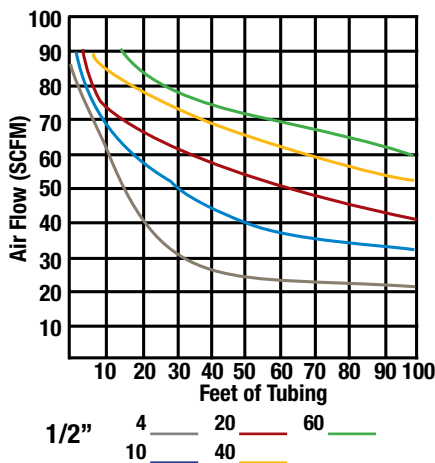
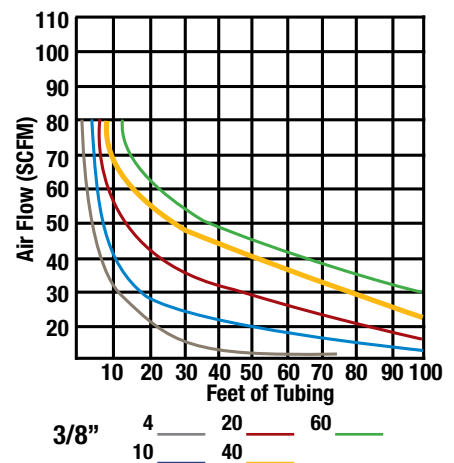
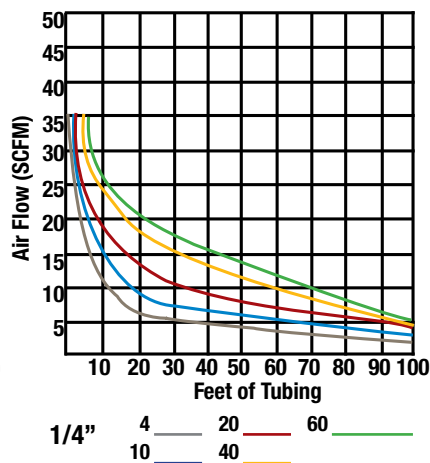
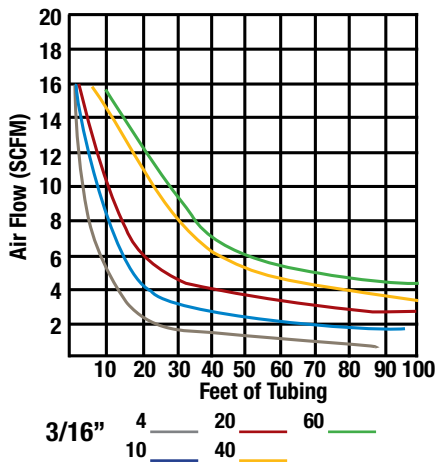

Actual working pressure charts are located in the tubing section on the specific product page.

For detailed ordering information, please consult price list or contact Parflex® Division.

Measuring Fast-Stor® Bulk Hose

Measuring Fast-Stor® hose is quick and easy and may be accomplished by either of two accurate methods:

1. Counting

Total Length of Hose			Number of Coils Needed to Obtain Required Net Extended Length +3%				
			3/16 I.D. Fast-Stor®	1/4 I.D. Fast-Stor®	3/8 I.D. Fast-Stor®	1/2 I.D. Fast-Stor®	3/4 I.D. Fast-Stor®
ft.	inch	mtr.	coils	coils	coils	coils	coils
3	36	.91	5-1/8	3-1/2	2-1/4	1-5/8	7/8
3	36	.91	5-1/8	3-1/2	2-1/4	1-5/8	7/8
5	60	1.52	8-1/2	5-3/4	3-7/8	2-5/8	1-1/2
7	84	2.13	12	8-1/8	5-3/4	3-3/4	1-1/8
10	120	3.05	17-1/8	11-1/2	7-3/4	5-3/8	3
12	144	3.66	20-1/2	13-7/8	9-1/4	6-1/2	3-1/2
15	180	4.57	25-3/4	17-3/8	11-1/2	8	4-1/2
16	192	4.88	27-3/8	18-1/2	12-3/8	8-5/8	4-3/4
17	204	5.18	29-1/8	19-5/8	13-1/8	9-1/8	5
19	216	5.79	30-7/8	20-3/4	13-7/8	9-5/8	5-3/8
20	240	6.10	34-1/4	23-1/8	15-3/8	10-3/4	6
25	300	7.62	42-7/8	28-7/8	19-1/4	13-3/8	7-1/2
30	360	9.14	51-3/8	34-5/8	23-1/8	16-1/8	8-7/8
33	396	10.06	56-1/2	38-1/8	25-3/8	17-3/4	9-3/4
50	600	15.24	85-5/8	57-3/4	38-1/2	26-7/8	14-7/8

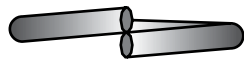

1 Full 360° Coil

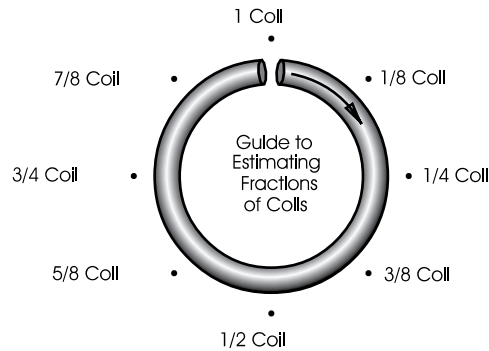
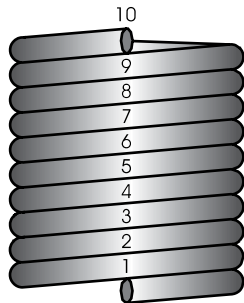

2. Division into Even Numbers of Lengths

Bulk retracted lengths of Fast-Stor® hose are always exactly 100 feet long when shipped from the factory. Some diameter expansion of the coils may occur in shipment due to temperature and storage conditions. This may appear to have shortened a given 100 foot retracted length slightly in relation to other 100 foot retracted lengths in the same master carton. The shorter appearance should not be mistaken for any actual shortage in extended length. A bulk retracted length may be easily divided into smaller lengths by first measuring the tightly retracted length in inches, and dividing by 4 to determine the cut-off length for 25 feet, by 3 for 33 feet, by 8 for 12-1/2 feet, etc. Pieces should be tagged with their proper length before returning to storage.

Cutting Bulk Length Coils

To cut bulk length coils, position coils on work table extending away from you, cut end-up in 12 o'clock position.

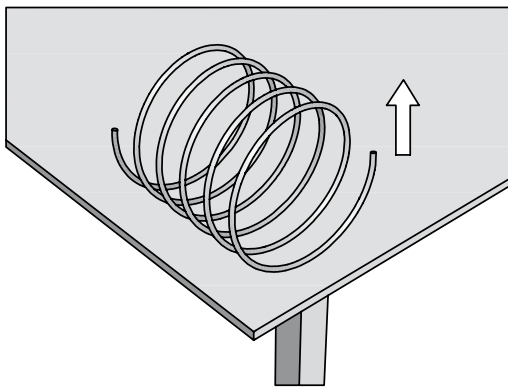

For detailed ordering information, please consult price list or contact Parflex® Division.

Parker Hannifin Corporation | Parflex® Division | Ravenna, Ohio | parker.com/pfd

www.comoso.com



C-7

A
Hose

B
Tubing

C
Coiled Air Hose
& Fittings

D
Transportation

E
Fittings

F
Tooling, Equipment
& Accessories

G
General Technical

Fast-Stor® Air Hose



Features

- Manufactured from tough, abrasion-resistant nylon
- Excellent memory characteristics over a wide temperature range
- Long service life in rugged applications
- Desirable Safety Yellow color per U.S. Government OSHA directives
- Optimal retail packaging available*

Applications/Markets



- Blow Guns
- Construction
- Mfg. Air Drops
- Machine Tool Lubrication
- Water Hose



Fast-Stor® Assemblies

Popular Stock Assemblies

Assembly Part Number	Hose I.D.		Total Length		Working Length		Nominal Compact Length		Coil I.D.		Maximum Working Pressure 73°F/23°C		Minimum Burst at 73°F/23°C		End Fittings
	inch	mm	ft.	mtr.	ft.	mtr.	ft.	mtr.	inch	mm	psi	MPa	psi	MPa	
#	○								○		↗		✂		
A0312-MC4-ML4	3/16	5	12	3.7	9	2.7	4.8	1.5	2	51	225	1.55	680	4.69	1/4" NPT
A0325-MC4-ML4	3/16	5	25	7.6	18	5.5	9.6	2.9	2	51	225	1.55	680	4.69	1/4" NPT
A0350-MC4-ML4	3/16	5	50	15.2	38	11.6	20.2	6.2	2	51	225	1.55	680	4.69	1/4" NPT
A0412-MC4-ML4*	1/4	6	12	3.7	9	2.7	4.3	1.3	3	76	225	1.55	680	4.69	1/4" NPT
A0425-MC4-ML4*	1/4	6	25	7.6	18	5.5	8.6	2.6	3	76	225	1.55	680	4.69	1/4" NPT
A0450-MC4-ML4	1/4	6	50	15.2	38	11.6	18.1	5.5	3	76	225	1.55	680	4.69	1/4" NPT
A0612-MC6-ML6*	3/8	10	12	3.7	9	2.7	4.3	1.3	4.5	114	225	1.55	680	4.69	3/8" NPT
A0625-MC6-ML6	3/8	10	25	7.6	18	5.5	8.5	2.6	4.5	114	225	1.55	680	4.69	3/8" NPT
A0650-MC6-ML6	3/8	10	50	15.2	38	11.6	17.9	5.5	4.5	114	225	1.55	680	4.69	3/8" NPT
A0812-MC8-ML8	1/2	13	12	3.7	9	2.7	4.3	1.3	6.5	165	225	1.55	680	4.69	1/2" NPT
A0825-MC8-ML8	1/2	13	25	7.6	18	5.5	8.5	2.6	6.5	165	225	1.55	680	4.69	1/2" NPT
A0850-MC8-ML8	1/2	13	50	15.2	38	11.6	16.8	5.1	6.5	165	225	1.55	680	4.69	1/2" NPT

Construction

Tube: Yellow PFX Nylon
Spring Guard: Steel
Fittings: Brass

Notes

*Retail packaging available - Add "R" suffix when ordering

Operating Parameters

Service temperature range: -40°F to +200°F
(-40°C to +93°C)

Maximum working pressure based on safety factor of 3:1 over burst



For detailed ordering information, please consult price list or contact Parflex® Division.

Parker Hannifin Corporation | Parflex® Division | Ravenna, Ohio | parker.com/pfd

www.comoso.com

Fast-Stor® Bulk Air Hose



Assembly Part Number	Hose I.D.		Average Wall Thickness		Coil I.D.		Coil O.D.		Total Length		Working Length		Master Carton Quantity		Maximum Working Pressure 73°F/23°C		Minimum Burst at 73°F/23°C	
	#																	
Black	inch	mm	inch	mm	inch	mm	inch	mm	ft.	mtr.	ft.	mtr.	ft.	mtr.	psi	MPa	psi	MPa
FS-03-100	3/16	5	.023	.58	2	51	2.5	64	100	30.5	75	22.9	600	183	225	160	680	469
FS-04-100	1/4	6	.030	.76	3	76	3.7	94	100	30.5	75	22.9	600	183	225	160	680	469
FS-06-100	3/8	10	.045	1.1	4.5	114	5.5	140	100	30.5	75	22.9	400	122	225	160	680	469
FS-08-100	1/2	13	.062	1.6	6.5	165	7.8	198	100	30.5	75	22.9	400	122	225	160	680	469
FS-12-100	3/4	19	.075	1.9	11	305	13.0	330	100	30.5	75	22.9	100	30	200	140	600	414

Construction

Tube: Yellow PFX Nylon

Operating Parameters

Service temperature range: -40°F to +200°F (-40°C to +93°C)

Maximum working pressure based on safety factor of 3:1 over burst

Order Information

Example: A0412-MC4-ML4

A0412-MC4-ML4 – Assembly

A0412-MC4-ML4 – Tube ID (1/4")

A0412-MC4-ML4 – Total Length (12')

A0412-MC4-ML4 – End 1 Fitting Size & Type
(1/4" Male NPT)

A0412-MC4-ML4 – End 2 Fitting Size & Type
(1/4" Male NPT, Swivel)



For detailed ordering information, please consult price list or contact Parflex® Division.

Parker Hannifin Corporation | Parflex® Division | Ravenna, Ohio | parker.com/pfd

www.comoso.com



C-9

A Hose

B Tubing

C Coiled Air Hose & Fittings

D Transportation

E Fittings

F Tooling, Equipment & Accessories

G General Technical

Fast-Stor® Fittings

Fittings for Fast-Stor® hose are constructed from heavy duty brass with built in insert-supports. Fitting bodies are SAE Standard sizes. Hose entry length into the fittings is the longest in the industry due to Parflex's SAE body design and size standardization, assuring a strong grip on the hose.

All fitting part numbers include body, nut, ferrule and spring guard. For body only, use Prefix B.

MC – Male Connector

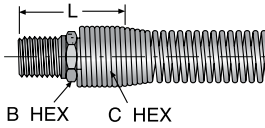

Part Number	Thread Size	Hose I.D.		L		B Hex		C Hex	
		inch	mm	inch	mm	inch	mm	inch	mm
#									
MC-03-2	1/8	3/16	5	1-3/8	35	9/16	14	1/2	13
MC-03-4	1/4	3/16	5	1-9/16	40	9/16	14	1/2	13
MC-04-2	1/8	1/4	6	1-3/8	35	9/16	14	9/16	14
MC-04-4	1/4	1/4	6	1-9/16	40	9/16	14	9/16	14
MC-06-6	3/8	3/8	10	1-13/16	46	11/16	17	13/16	21
MC-08-6	3/8	1/2	13	2-1/8	54	7/8	22	15/16	24
MC-08-8	1/2	1/2	13	2-1/8	54	7/8	22	15/16	24
*MC-12-12	3/4	3/4	19	2-1/4	57	1-1/4	32	1-3/8	35

*No spring guard required.

ME – Male 90° Elbow

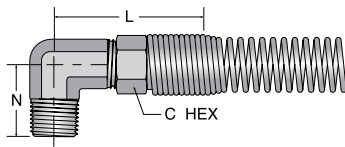

Part Number	Thread Size	Hose I.D.		L		N		C Hex	
		inch	mm	inch	mm	inch	mm	inch	mm
#									
ME-03-4	1/4	3/16	5	1-1/4	32	15/16	24	9/16	14
ME-04-4	1/4	1/4	6	1-13/16	46	15/16	24	9/16	14
ME-06-6	3/8	3/8	10	1-9/16	40	1-1/8	29	13/16	21
ME-08-8	1/2	1/2	13	1-3/4	44	1-3/8	35	15/16	24

ML – Live Male Pipe Swivel

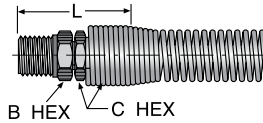

Part Number	Thread Size	Hose I.D.		L		B Hex		C Hex	
		inch	mm	inch	mm	inch	mm	inch	mm
#									
ML-03-4	1/4	3/16	5	1-1/16	27	9/16	14	1/2	13
ML-04-4	1/4	1/4	6	1-9/16	40	9/16	14	9/16	14
ML-06-6	3/8	3/8	10	1-7/8	47	3/4	19	13/16	21
ML-08-8	1/2	1/2	13	2-3/8	60	7/8	22	15/16	24

FC – Female Connector FPT

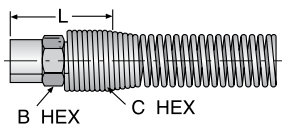

Part Number	Thread Size	Hose I.D.		L		B Hex		C Hex	
		inch	mm	inch	mm	inch	mm	inch	mm
#									
FC-04-4	1/4	1/4	6	1-9/16	40	11/16	17	9/16	14
FC-06-6	3/8	3/8	10	1-3/4	44	13/16	21	13/16	21

FL – Female Pipe Swivel*

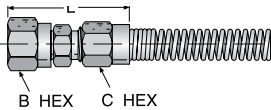

Part Number	Thread Size	Hose I.D.		L		B Hex		C Hex		Box Quantity
		inch	mm	inch	mm	inch	mm	inch	mm	
#										
FL-04-4	1/4	1/4	6	1-3/4	44	5/8	16	9/16	14	20
FL-06-6	3/8	3/8	10	2-1/8	54	3/4	19	9/16	14	10

*Fitting does not swivel after assembly.

For detailed ordering information, please consult price list or contact Parflex® Division.

Parker Hannifin Corporation | Parflex® Division | Ravenna, Ohio | parker.com/pfd

www.comoso.com



Fast-Stor® Union Connector

UC – Union Connector

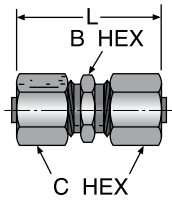

Part Number	Thread Size	Hose I.D.		L		B Hex		C Hex	
		inch	mm	inch	mm	inch	mm	inch	mm
#									
UC-04-4	1/4 x 1/4 I.D.	1/4	6	1-7/8	48	1/2	13	9/16	14
UC-06-6	3/8 x 3/8 I.D.	3/8	10	2-5/8	67	11/16	17	13/16	21

Fast-Stor® Replacement Parts

FN – Brass Nut

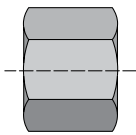

Part Number	Hose I.D.	
	inch	mm
#		
FN-03	3/16	5
FN-04	1/4	6
FN-06	3/8	10
FN-08	1/2	13
FN-12	3/4	19

FR – Plastic Ferrule

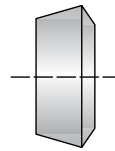

Part Number	Hose I.D.	
	inch	mm
#		
FR-03	3/16	5
FR-04	1/4	6
FR-06	3/8	10
FR-08	1/2	13
FR-12*	3/4	19

* Brass.

SG – Steel Spring Guard



Part Number	Hose I.D.	
	inch	mm
#		
SG-03	3/16	5
SG-04	1/4	6
SG-06	3/8	10
SG-08	1/2	13

TS – Tube Support

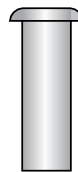

Part Number	Hose I.D.	
	inch	mm
#		
TS-03	3/16	5
TS-04	1/4	6
TS-06	3/8	10
TS-08	1/2	13
TS-12	3/4	19

How to Assemble Fast-Stor® Hose

- Using a Parker Model 316 cutoff tool, Parflex PHC hand cutter or other sharp cutter, cut hose squarely to correct length.
- Install SG spring guard on hose as shown. A guard is not required on size -12 hose.
- Slide FN nut on hose and insert TS tube support.
- Slide FR plastic ferrule over hose with taper side toward cut end of hose. Size -12 hose uses a brass ferrule and requires the hose end to be dipped in clean water for lubrication.
- Push hose into fitting body until bottomed. Slide nut and ferrule up to fitting body and tighten nut by hand. With a wrench, tighten the nut additional 2 to 2-1/2 turns.
- Slide spring guard over nut until the lead coil snaps between the nut and fitting body hex.

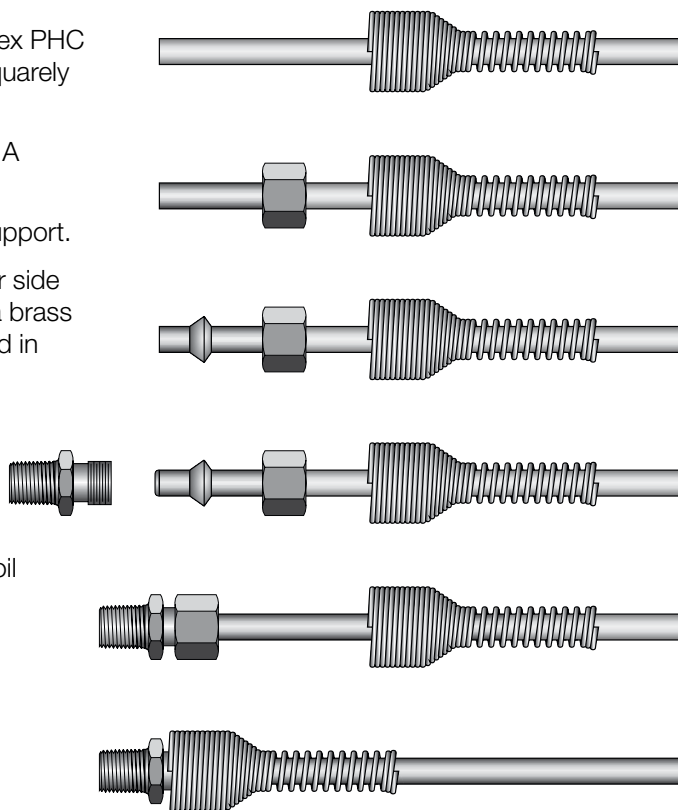

For detailed ordering information, please consult price list or contact Parflex® Division.

Parker Hannifin Corporation | Parflex® Division | Ravenna, Ohio | parker.com/pfd

www.comoso.com



C-13

A Hose

B Tubing

C Coiled Air Hose & Fittings

D Transportation

E Fittings

F Tooling, Equipment & Accessories

G General Technical

Parflex NoMar™ Fast-Stor® Assemblies AUFS



Features

- Manufactured from durable, abrasion-resistant Polyurethane
- Excellent memory characteristics over a wide temperature range
- Field-attachable fittings
- Available in bulk or factory-made assemblies

Applications/Markets



- Auto Repair
- Blow Guns
- Construction
- Carpentry
- Furniture Manufacturing
- Mfg. Air Drops
- Marine
- Water Hose

Urethane Fast-Stor® Assemblies

Includes live male end and rigid male end

Assembly Part Number	Hose O.D.		Hose I.D.		Total Length		Nominal Compact Length		Nominal Coil I.D.		Maximum Working Pressure 73°F/23°C		Minimum Burst at 73°F/23°C		End Fittings
	inch	mm	inch	mm	ft.	mtr.	inch	mm	inch	mm	psi	MPa	psi	MPa	
#															
AUFS-32-TBLU-010**	3/16	5	1/8	3	10	3.0	6.6	167	3/4	19	135	.93	405	2.79	1/8" NPT
AUFS-32-TBLU-025**	3/16	5	1/8	3	25	7.6	19	482	3/4	19	135	.93	405	2.79	1/8" NPT
AUFS-42-TBLU-010	1/4	6	1/8	3	10	3.0	8.3	210	3/4	19	175	1.21	525	3.62	1/4" NPT
AUFS-42-TBLU-025	1/4	6	1/8	3	25	7.6	23.9	607	3/4	19	175	1.21	525	3.62	1/4" NPT
AUFS-64-TBLU-010*	3/8	10	1/4	6	10	3.0	5.6	142	1-3/4	44	180	1.24	540	3.72	1/4" NPT
AUFS-64-TBLU-015*	3/8	10	1/4	6	15	4.6	9.3	236	1-3/4	44	180	1.24	540	3.72	1/4" NPT
AUFS-64-TBLU-020	3/8	10	1/4	6	20	6.1	13	330	1-3/4	44	180	1.24	540	3.72	1/4" NPT
AUFS-64-TBLU-025*	3/8	10	1/4	6	25	7.6	16	406	1-3/4	44	180	1.24	540	3.72	1/4" NPT
AUFS-85-TBLU-010	1/2	13	21/64	8	10	3.0	5.5	140	2-1/2	64	150	1.03	450	3.10	3/8" NPT
AUFS-85-TBLU-015	1/2	13	21/64	8	15	4.6	9	229	2-1/2	64	150	1.03	450	3.10	3/8" NPT
AUFS-85-TBLU-020	1/2	13	21/64	8	20	6.1	12.5	317	2-1/2	64	150	1.03	450	3.10	3/8" NPT
AUFS-85-TBLU-025	1/2	13	21/64	8	25	7.6	16	406	2-1/2	64	150	1.03	450	3.10	3/8" NPT
AUFS-86-TBLU-010	1/2	13	3/8	10	10	3.0	5.5	140	2-1/2	64	110	.76	330	2.28	3/8" NPT
AUFS-86-TBLU-020	1/2	13	3/8	10	20	6.1	12.5	317	2-1/2	64	110	.76	330	2.28	3/8" NPT
AUFS-96-TBLU-010	9/16	14	3/8	10	10	3.0	6.1	155	2-1/2	64	140	.97	420	2.90	3/8" NPT
AUFS-96-TBLU-015	9/16	14	3/8	10	15	4.6	9.9	251	2-1/2	64	140	.97	420	2.90	3/8" NPT
AUFS-96-TBLU-020	9/16	14	3/8	10	20	6.1	13.7	348	2-1/2	64	140	.97	420	2.90	3/8" NPT
AUFS-96-TBLU-025	9/16	14	3/8	10	25	7.6	17.5	444	2-1/2	64	140	.97	420	2.90	3/8" NPT

Assembly Part Number	Hose O.D.		Hose I.D.		Total Length		Nominal Compact Length		Nominal Coil I.D.		Maximum Working Pressure 73°F/23°C		Minimum Burst at 73°F/23°C		End Fittings
	#														
	inch	mm	inch	mm	ft.	mtr.	inch	mm	inch	mm	psi	MPa	psi	MPa	
AUFS-128-TBLU-010	3/4	19	1/2	13	10	3.0	7.5	190	3	76	125	.86	375	2.59	1/2" NPT
AUFS-128-TBLU-015	3/4	19	1/2	13	15	4.6	11.2	284	3	76	125	.86	375	2.59	1/2" NPT
AUFS-128-TBLU-020	3/4	19	1/2	13	20	6.1	15	381	3	76	125	.86	375	2.59	1/2" NPT
AUFS-128-TBLU-025	3/4	19	1/2	13	25	7.6	19.5	495	3	76	125	.86	375	2.59	1/2" NPT

Construction

Tube: Transparent Blue Polyurethane

Fittings: Brass

Operating Parameters

Service temperature range: -40°F to +180°F (-40°C to +82°C)

Notes

Pigtail Lengths - 16" swivel end, 8" rigid end

*Retail packaging available - Add "R" suffix when ordering

**Size -32 comes standard with two rigid ends

Other sizes available upon request

Colors

Color Code		
	TBLU	Transparent Blue

Other colors available upon request - consult factory

Order Information

Example: AUFS-64-TBLU-025

AUFS-64-TBLU-025 - Assembled Urethane Fast-Stor

AUFS-**64**-TBLU-025 - Tube OD (3/8")

AUFS-64-**TBLU**-025 - Tube ID (1/4")

AUFS-64-**TBLU**-025 - Color (Transparent Blue)

AUFS-64-TBLU-**025** - Total Length (25')

For detailed ordering information, please consult price list or contact Parflex® Division.

Parker Hannifin Corporation | Parflex® Division | Ravenna, Ohio | parker.com/pfd

www.comoso.com



C-15

A
Hose

B
Tubing

C
Coiled Air Hose
& Fittings

D
Transportation

E
Fittings

F
Tooling, Equipment
& Accessories

G
General Technical

Parflex NoMar™ Fast-Stor® Coiled Tubing UFS



Features

- Manufactured from durable, abrasion-resistant Polyurethane
- Excellent memory characteristics over a wide temperature range
- Long service life in rugged applications

Applications/Markets



- Auto Repair
- Blow Guns
- Construction

- Mfg. Air Drops
- Marine
- Water Hose



- Carpentry
- Furniture Manufacturing

Assembly Part Number	Hose O.D.		Hose I.D.		Working Length	Nominal Coil I.D.		Maximum Working Pressure 73°F/23°C		Minimum Burst at 73°F/23°C	
	inch	mm	inch	mm		inch	mm	psi	MPa	psi	MPa
#											
	inch	mm	inch	mm	feet	inch	mm	psi	MPa	psi	MPa
UFS-32-TBLU-xxx	3/16	5	1/8	3	010, 025	3/4	19	135	.93	405	2.79
UFS-42-TBLU-xxx	1/4	6	1/8	3	010, 025	3/4	19	175	1.21	525	3.62
UFS-64-TBLU-xxx	3/8	10	1/4	6	010, 015, 020, 025	1-3/4	44	180	1.24	540	3.72
UFS-85-TBLU-xxx	1/2	13	21/64	8	010, 015, 020, 025	2-1/2	64	150	1.03	450	3.10
UFS-86-TBLU-xxx	1/2	13	3/8	10	010, 020	2-1/2	64	110	.76	330	2.28
UFS-96-TBLU-xxx	9/16	17	3/8	10	010, 015, 020, 025	2-1/2	64	140	.97	420	2.90
UFS-128-TBLU-xxx	3/4	19	1/2	13	010, 015, 020, 025	3	76	125	.86	375	2.59

Construction

Tube: Transparent Blue Polyurethane

Operating Parameters

Service temperature range: -40°F to +180°F (-40°C to +82°C)

Maximum working pressure based on safety factor of 3:1 over burst

Order Information

Example: UFS-86-TBLU-010

UFS-86-TBLU-010 – Assembled NoMar™ Fast-Stor

UFS-86-TBLU-010 – Tube OD (1/2")

UFS-86-TBLU-010 – Tube ID (3/8")

UFS-86-TBLU-010 – Color (Transparent Blue)

UFS-86-TBLU-010 – Total Length (10')

Notes

xxx- Denotes Hose Length (feet)

Pigtail Lengths - 16" End #1, 8" End #2

Other sizes available upon request

Colors

Color Code		
	TBLU	Transparent Blue

Other colors available upon request - consult factory

Parflex NoMar™ Fast-Stor® Coiled Assembly AHUFS



Features

- Manufactured from durable, abrasion-resistant 98 Durometer Polyurethane
- Excellent memory characteristics over a wide temperature range
- Long service life in rugged applications

Applications/Markets



- Auto Repair
- Blow Guns
- Construction
- Carpentry
- Furniture Manufacturing
- Mfg. Air Drops
- Marine
- Water Hose

Assembly Part Number	Hose O.D.		Hose I.D.		Working Length		Nominal Compact Length		Coil I.D.		Maximum Working Pressure 73°F/23°C		Minimum Burst at 73°F/23°C	
	inch	mm	inch	mm	ft.	mtr.	inch	mm	inch	mm	psi	MPa	psi	MPa
#														
AHUFS-6-xxx-015	3/8	10	1/4	6	15	4.6	13	330	1-1/4	32	180	1.24	540	3.72
AHUFS-6-xxx-025	3/8	10	1/4	6	25	6.7	22	559	1-1/4	32	180	1.24	540	3.72

Construction

Tube: 98 Durometer Polyurethane
Fitting: Brass

Operating Parameters

Service temperature range: -40°F to +180°F (-40°C to +82°C)

Maximum working pressure based on safety factor of 3:1 over burst.

Notes

xxx- Denotes Color

Retail packaging available - Add "R" suffix when ordering

Pigtail Lengths - 16" End #1, 8" End #2

Other sizes available upon request

Colors

Color Code		
	BLK	Black
	BLU	Blue
	RED	Red
	YEL	Yellow

Other colors available upon request - consult factory

Order Information

Example: AHUFS-6-BLK-015

AHUFS-6-BLK-015 – Assembled High Durometer Urethane Fast-Stor

AHUFS-6-BLK-015 – Tube OD (3/8")

AHUFS-6-BLK-015 – Color (Black)

AHUFS-6-BLK-015 – Total Length (15')

For detailed ordering information, please consult price list or contact Parflex® Division.

Parker Hannifin Corporation | Parflex® Division | Ravenna, Ohio | parker.com/pfd

www.comoso.com



C-17

A Hose
B Tubing
C Coiled Air Hose & Fittings
D Transportation
E Fittings
F Tooling, Equipment & Accessories
G General Technical

Parflex NoMar™ Fast-Stor® Fittings

Parflex NoMar™ Fast-Stor® fittings are manufactured from a heavy brass construction utilizing all standards for NPTF pipe threads. The engineered barb design generates the maximum gripping and sealing power when combined with the socket.

MCB Male Pipe Rigid

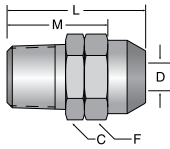

Part Number	Hose Part Number	Thread Size	Hose I.D.		L		Cutoff M		C Hex		F Hex	
			inch	mm	inch	mm	inch	mm	inch	mm	inch	mm
#	#											
MCB-3x2-2	UFS-32	1/8 NPT	0.11	2.8	0.94	23.8	0.72	18.3	7/16	11	7/16	11
MCB-4x2-2	UFS-42	1/8 NPT	0.12	3.0	1.00	25.4	0.74	18.8	7/16	11	7/16	11
MCB-4x2-4	UFS-42	1/4 NPT	0.12	3.0	1.16	29.5	0.90	22.9	9/16	14	7/16	11
MCB-6x4-4	UFS-64	1/4 NPT	0.23	5.8	1.16	29.5	0.90	22.9	5/8	16	5/8	16
MCB-6x4-6	UFS-64	3/8 NPT	0.23	5.8	1.20	30.5	0.94	23.9	3/4	19	5/8	16
MCB-8x5-6	UFS-85	3/8 NPT	0.27	6.9	1.29	32.8	0.99	25.1	3/4	19	3/4	19
MCB-8x6-4	UFS-86	1/4 NPT	0.28	7.1	1.29	32.8	1.03	26.1	3/4	19	3/4	19
MCB-8x6-6	UFS-86	3/8 NPT	0.34	6.6	1.30	33.0	1.04	26.4	3/4	19	3/4	19
MCB-9x6-6	UFS-96	3/8 NPT	0.31	7.9	1.47	37.3	1.10	27.9	7/8	22	7/8	22
MCB-9x6-8	UFS-96	1/2 NPT	0.32	8.1	1.61	40.9	1.24	31.5	7/8	22	7/8	22
MCB-12x8-8	UFS-128	1/2 NPT	0.42	10.7	1.98	50.0	0.94	24.0	1	25	1	25

MLB Male Live Swivel

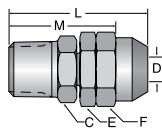

Part Number	Hose Part Number	Thread Size	Hose I.D.		L		Cutoff M		C Hex		E Hex		F Hex	
			inch	mm	inch	mm	inch	mm	inch	mm	inch	mm	inch	mm
#	#													
MLB-4x2-4	UFS-42	1/4 NPT	0.12	3.0	1.37	34.8	1.11	28.2	9/16	14	7/16	11	9/16	14
MLB-6x4-4	UFS-64	1/4 NPT	0.22	5.6	1.37	34.8	1.11	28.2	9/16	14	5/8	16	5/8	16
MLB-6x4-6	UFS-64	3/8 NPT	0.23	5.8	1.58	40.1	1.32	33.5	3/4	19	5/8	16	5/8	16
MLB-8x5-6	UFS-85	3/8 NPT	0.27	6.9	1.68	42.7	1.38	35.1	3/4	19	3/4	19	3/4	19
MLB-8x6-6	UFS-86	3/8 NPT	0.33	8.4	1.71	43.4	1.45	36.8	3/4	19	3/4	19	3/4	19
MLB-9x6-6	UFS-96	3/8 NPT	0.31	7.9	1.87	47.5	1.50	38.1	3/4	19	7/8	22	7/8	22
MLB-9x6-8	UFS-96	1/2 NPT	0.31	7.9	1.95	49.5	1.58	40.1	15/16	24	7/8	22	7/8	22
MLB-12x8-8	UFS-128	1/2 NPT	0.42	10.7	2.30	56.5	1.26	32.0	7/8	22	1	25	1	25

Assembly Instructions

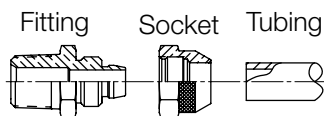

1. Slide the socket on the tubing with threads facing the end of the tubing.
2. Press the tubing over the Tube Support portion of the fitting until the tube bottoms out. Do not use a lubricant.
3. Push the socket up to meet the mating threads on the fitting, finger tighten the socket onto the fitting.
4. Tighten the fitting and socket until the fitting hex and socket hex meet.

For detailed ordering information, please consult price list or contact Parflex® Division.

Parker Hannifin Corporation | Parflex® Division | Ravenna, Ohio | parker.com/pfd

www.comoso.com



Ultra-Lite Superbraid Hose



Features

- More than 20% lighter than similar braided polyurethane hoses
- Extremely tough and abrasion resistant
- State-of-the-art strain relief system allows the hose to bend freely without kinking at the fitting
- Features lightweight, non-marring jacket

Applications/Markets



- Auto Repair
- Blow Guns
- Construction
- Carpentry

- Mfg. Air Drops
- Marine
- Water Hose



- Furniture Manufacturing

Part Number	Nominal I.D.		Nominal O.D.		Total Length	Maximum Working Pressure 73°F/23°C		Fitting Size & Type
	inch	mm	inch	mm		psi	MPa	
#								
					feet			
SB-4-B-xxx-ML4 SB-4-Y-xxx-ML4	1/4	6	3/8	10	025, 050, 100	220	1.52	1/4" Male NPT, Swivel
SB-5-B-xxx-ML6 SB-5-Y-xxx-ML6	5/16	8	15/32	12	025, 050, 100	185	1.28	3/8" Male NPT, Swivel
SB-6-Y-xxx-ML4	3/8	10	.515	13	025, 050, 100	200	1.38	1/4" Male NPT, Swivel
SB-6-Y-xxx-ML6	3/8	10	.515	13	025, 050, 100	200	1.38	3/8" Male NPT, Swivel
SB-6-Y-xxx-MC4	3/8	10	.515	13	025, 050, 100	200	1.38	1/4" Male NPT, Rigid
SB-6-Y-xxx-MC6	3/8	10	.515	13	025, 050, 100	200	1.38	3/8" Male NPT, Rigid

Construction

Tube: Polyurethane
Reinforcement: Polyester
Cover: Polyurethane
Fittings: Brass
O-rings: Buna-N
Strain Relief Sleeves: Acetal

Operating Parameters

Temperature Range: -40°F to +165°F
(-40°C to + 74°C)

Fittings

Parker Fittings available from:
Fluid System Connectors Division
Otsego, MI
(269) 692-6555
(269) 694-4614 FAX

Notes

xxx- Denotes Hose Length

Field Attachable Fittings

Hose Size	Fitting Size	Fitting Type	F.A. Fitting	F.A. Fitting & Strain Relief
Inch	Inch		Part Number*	Part Number**
1/4	1/4	Male NPT, Swivel	06244S	07244S
5/16	1/4	Male NPT, Swivel	06254S	-
5/16	3/8	Male NPT, Swivel	06256S	-
3/8	1/4	Male NPT, Rigid	06264RU	07264RU
3/8	1/4	Male NPT, Swivel	06264SU	07264SU
3/8	3/8	Male NPT, Swivel	06266SU	07266SU
1/4	-	Hose Splicer	06244-HS	-
3/8	-	Hose Splicer	06266-HSU	-

* Includes Fitting & Nut (No Strain Relief).

** Includes Fitting & Nut with permanently attached strain relief.



Parflex Field Attachable Fittings do not require inserts or ferrules that become deformed during installation, so the fittings can be used over again without replacing any components. In addition, only two wrenches are needed to complete a safe and secure connection, making fitting replacement quick and easy!



For detailed ordering information, please consult price list or contact Parflex® Division.

SB – Bulk Hose Without Fittings

Part Number	Nominal I.D.		Nominal O.D.		Working Length	Maximum Working Pressure	
	inch	mm	inch	mm		psi	MPa
#							
SB-4-B-xxx SB-4-Y-xxx	1/4	6	3/8	10	025, 050, 100, 500	220	1.52
SB-5-B-xxx SB-5-Y-xxx	5/16	8	15/32	12	025, 050, 100, 300	185	1.28
SB-6-Y-xxx	3/8	10	.515	13	025, 050, 100, 500	200	1.38

Order Information

Example: SB-4-Y-050-ML4

SB-4-Y-050-ML4 – Super Braid

SB-4-Y-050-ML4 – Hose ID (1/4")

SB-4-Y-050-ML4 – Color (Yellow)

SB-4-Y-050-ML4 – Total Length (50')

**SB-4-Y-050-ML4 – Fittings Size & Type
(1/4' Male NPT, Swivel)**

Color Code		
	TBLU	Transparent Blue
	YEL	Yellow

For detailed ordering information, please consult price list or contact Parflex® Division.

Parker Hannifin Corporation | Parflex® Division | Ravenna, Ohio | parker.com/pfd

www.comoso.com



C-21

Hose
A

Tubing
B

Coiled Air Hose
& Fittings
C

Transportation
D

Fittings
E

Tooling, Equipment
& Accessories
F

General Technical
G

Notes





Transportation

Air Brake Tubing

Diesel Fuel Tubing

High Temperature Fuel Tubing

Truck Coils

Cut Tubes

Formed Tubes

Jacketed Bundles

Air Brake Harnesses

SCR Hose

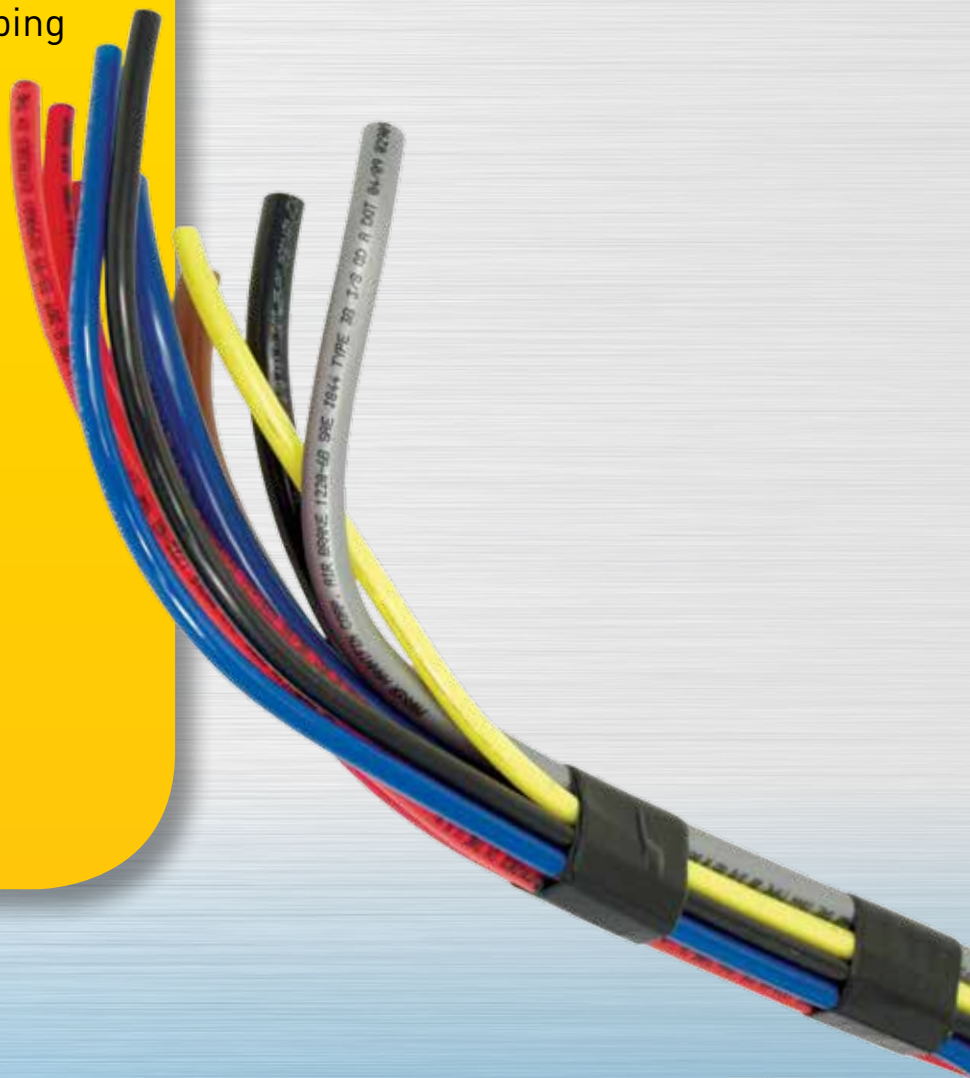





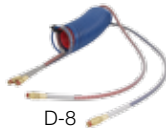









Table of Contents

Air Brake TubingD-4
 PFT-FL Diesel Fuel TubingD-5
 HTFL Diesel Fuel Tubing, High TempD-6
 BRAKCoil®D-7
 Duo-Coil™D-8
 DollyCoil™D-9

SliderCoil™D-10
 Fifth Wheel SliderD-11
 Cut TubesD-12
 Formed Tubes and HosesD-12
 Jacketed BundlesD-12
 Straight HarnessesD-12

Formed HarnessesD-12
 SCR HoseD-13

Transportation Visual Index

Transportation Products	Air Brake Tubing	PFT-FL Diesel Fuel Tubing	HTFL High-Temperature Diesel Fuel Tubing	BRAKCoil®	Duo-Coil®
	 D-4	 D-5	 D-6	 D-7	 D-8
	DollyCoil™	SliderCoil™	Fifth Wheel Slider	Cut Tubes	Formed Tubes & Hoses
	 D-9	 D-10	 D-11	 D-12	 D-12
	Jacketed Bundles	Straight Harnesses	Formed Harnesses	SCR Hose	
	 D-12	 D-12	 D-12	 D-13	



Parflex Transportation Products

Formed Dash Harnesses
Transmission Air Shift Bundles
Cab Tilt Lines

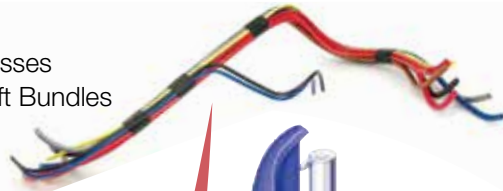

Air Brake Tubing
Air Brake Harnesses



Slider Coils
Tire Inflation Hoses

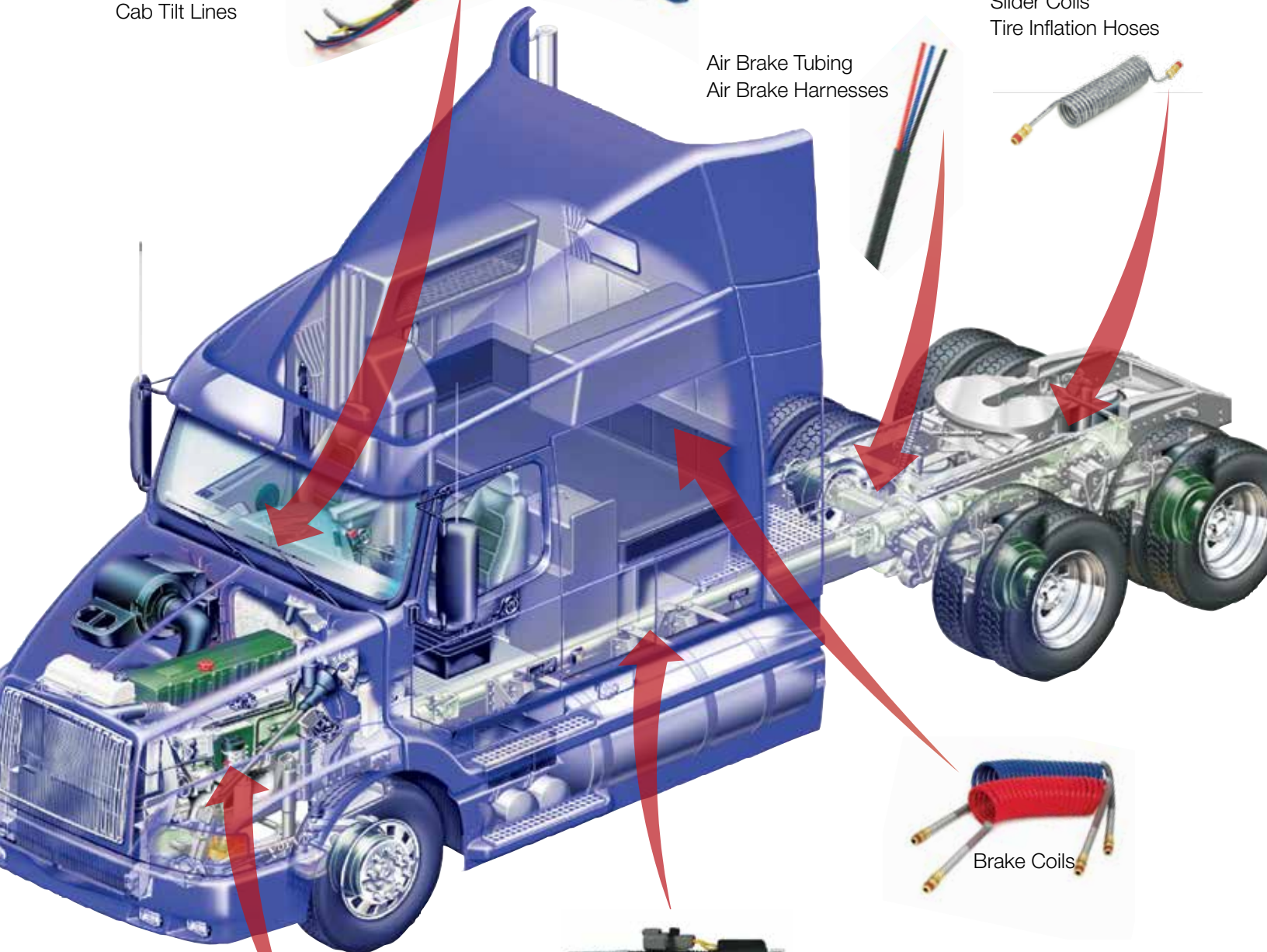

Brake Coils



Heated SCR Hose
Fuel Tubing
High Temp Fuel Lines



Compressor Discharge Lines
Formed Power Steering Hoses

For detailed ordering information, please consult price list or contact Parflex® Division.

Parker Hannifin Corporation | Parflex® Division | Ravenna, Ohio | parker.com/pfd

www.comoso.com



1120 Nylon Air Brake Tubing

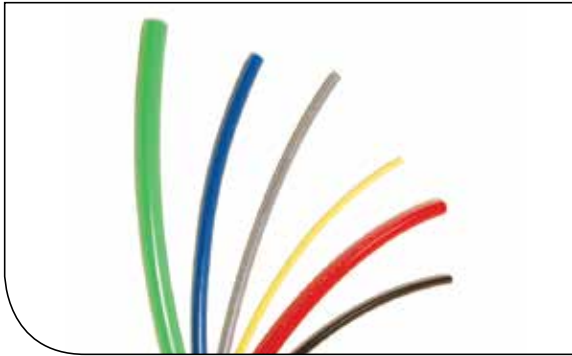

Features

- 100% Pressure Tested
- Excellent UV Stability
- Abrasion Resistant
- Kink Resistant

Certifications

- Meets SAE Specification J844
- Meets DOT FMVSS 49CFR 571.106

Applications/Markets



- Air brake lines

Part Number	Tube O.D.	Outside Diameter		Inside Diameter		Nominal Wall Thickness		Burst Pressure at 73°F / 23°C		Minimum Bend Radius		Weight		Standard Reel		Standard Pallet	
		inch	mm	inch	mm	inch	mm	psi	bar	inch	mm	lbs./100 ft.	kg./31 mtr.	feet	meter	feet	meter
#																	
1120-2A-XXX-1000	1/8	.125	3.2	.079	2.0	.023	0.6	1000	69.0	.370	9.4	.340	.154	1000	305	24,000	7315
1120-2.5A-XXX-1000	5/32	.156	4.0	.092	2.3	.032	0.8	1200	82.7	.500	12.7	.570	.259	1000	305	24,000	7315
1120-3A-XXX-1000	3/16	.188	4.8	.118	3.0	.035	0.9	1200	82.7	.750	19.1	.770	.349	1000	305	24,000	7315
1120-4A-XXX-1000	1/4	.250	6.4	.170	4.3	.040	1.0	1200	82.7	1.00	25.4	1.21	.549	1000	305	24,000	7315
1120-5A-XXX-500	5/16	.313	7.9	.232	5.9	.040	1.0	1000	69.0	1.25	31.8	1.57	.712	500	152	12,000	3658
1120-6B-XXX-500	3/8	.375	9.5	.251	6.4	.062	1.6	1400	96.5	1.50	38.1	2.70	1.22	500	152	12,000	3658
1120-8B-XXX-500	1/2	.500	12.7	.376	9.6	.062	1.6	950	65.5	2.00	50.8	3.90	1.77	500	152	6,000	3658
1120-10B-XXX-250	5/8	.625	15.9	.441	11.2	.092	2.3	900	62.1	2.50	63.5	7.00	3.18	250	76	3,000	914
1120-12B-XXX-250	3/4	.750	19.1	.566	14.4	.092	2.3	800	55.2	3.00	76.2	8.60	3.90	250	76	3,000	914

XXX represents color code.

Construction

Material:
Type A – Single-wall extruded Nylon (polyamide)

Type B – Nylon (polyamide) core, fiber reinforcement, Nylon (polyamide) cover/sheath

Operating Parameters

Temperature Range:
-40°F to +200°F (-40°C to +93°C)

Working Pressure: 150 psi (10.3 bar)

Fittings

Parker Fittings available from:
Fluid System Connectors Division
Otsego, MI
(269) 692-6555
(269) 694-4614 FAX

FSC Product Families:

- NTA
- PMT
- PTC

Colors

Color Code		
●	BLK	Black
●	BLU	Blue
●	BRN	Brown
●	GRN	Green
●	ORG	Orange
●	PUR	Purple
●	RED	Red
●	SIL	Silver
●	TAN	Tan
●	YEL	Yellow
○	WHT	White

Parflex Diesel Fuel Tubing



Features

- Nylon tubing designed for use in tractor, trailer and other mobile fuel systems
- Heat and light stabilized
- 100% quality controlled - 100% pressure tested
- Saves weight and labor in comparison with hose and hard-line tubing

Approvals

- Compatible with JP-5 (MIL-DTL-5624) and JP-8 (MIL-DTL-83133)
- Compatible with Biodiesel per Parflex PPB PL-18 hard-line tubing

Applications/Markets



- D.O.T. diesel fuel applications

Part Number	Nominal Tube O.D.		Nominal Tube I.D.		Minimum Bend Radius		Weight		Standard Reel	
	inch	mm	inch	mm	inch	mm	lbs./ft.	kg./mtr.	feet	meter
#										
PFT-4A-XXX-1000-FL	1/4	6	.170	4	1	25	.012	.005	1000	305
PFT-6B-XXX-500-FL	3/8	10	.251	6	1-1/2	38	.027	.012	500	152
PFT-8B-XXX-500-FL	1/2	13	.376	10	2	51	.039	.018	500	152
PFT-10B-XXX-250-FL	5/8	16	.441	11	2-1/2	64	.070	.032	250	76
PFT-12B-XXX-250-FL	3/4	19	.566	14	3	76	.086	.039	250	76

XXX represents color code.

Construction

Heat and light stabilized seamless extruded nylon core reinforced with fibrous reinforcement and bonded with a protective blue nylon cover sheath

Operating Parameters

Temperature Range:

-40°F to +200°F (-40°C to +93°C)

Maximum Working Pressure: 150 psi (10.3 bar)

Do not exceed temperature and pressure ranges

Color

- BLU

Blue is standard

Consult division for additional colors

Fittings

Parker Fittings available from:
Fluid System Connectors Division
Otsego, MI
(269) 692-6555
(269) 694-4614 FAX

FSC Product Families:

- NTA
- DF (Diesel Fuel Only)

Notes

Contact Parflex Division for application review

For detailed ordering information, please consult price list or contact Parflex® Division.

Parker Hannifin Corporation | Parflex® Division | Ravenna, Ohio | parker.com/pfd

www.comoso.com



HTFL Diesel Fuel Line Tubing (High-Temperature)



Features

- Heat and UV stabilized
- For use in high temperature applications
- 100% Pressure Tested
- Lightweight
- Pre-formed tubes available

Applications/Markets



Part Number	Nominal Tube O.D.		Nominal Tube I.D.		Nominal Wall Thickness		Working Pressure		Minimum Burst at 73°F / 23°C		Minimum Bend Radius		Weight		Standard Reel	
	inch	mm	inch	mm	inch	mm	psi	bar	psi	bar	inch	mm	lbs./ft.	kg./mtr.	feet	meter
#																
HTFL-6B-BRN-500	3/8	10	.251	6	.062	1.6	175	12.1	1,400	96.5	1-1/2	38	.028	.013	500	152
HTFL-8B-BRN-500	1/2	13	.376	10	.062	1.6	155	10.7	950	65.5	2	51	.039	.018	500	152
HTFL-10B-BRN-250	5/8	16	.441	11	.092	1.6	140	9.7	900	62.1	2-7/8	73	.071	.032	250	76
HTFL-12B-BRN-250	3/4	19	.566	14	.092	1.6	150	10.3	800	55.1	3	76	.086	.039	250	76

Construction

Tube: High-temperature and chemical-resistant special polyamide

Reinforcement: High-strength yarn fiber

Cover: High-temperature and UV-resistant special polyamide

Color

● BRN

Brown is standard

Consult division for additional colors

Notes

Compatible with JP-5 (MIL-DTL-5624) and JP-8 (MIL-DTL-83133)

Compatible with Biodiesel per Parflex PPB PL-18

Operating Parameters

Temperature Range:

-50°F to +266°F (-46°C to +130°C)

Vacuum Rating: 28 inch Hg

Fittings

Parker Fittings available from:

Fluid System Connectors Division

Otsego, MI

(269) 692-6555

(269) 694-4614 FAX

FSC Product Families:

NTA

BRAKCOIL®

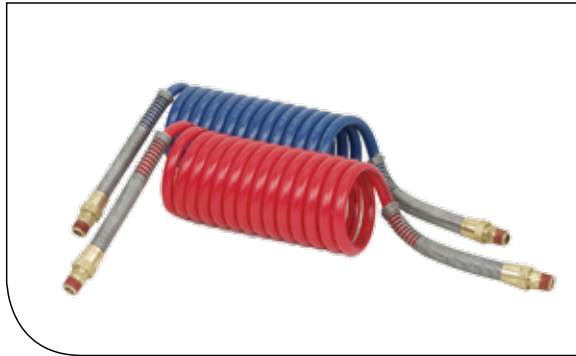

Features

- Tractor-to-trailer coiled nylon air-brake connections
- Maintenance-free performance - designed for trouble-free service on your rig
- Years of city delivery and line haul testing
- Heavy-duty plated spring guards are rust-resistant for added protection
- More coils offer you maximum working lengths
- No need for pogo sticks or spring hangers
- Color coding gives you mistake-free hook-ups - blue for service, red for emergency

Certifications

- Meets or exceeds SAE J844 and D.O.T. FMVSS 106 Specifications at -70°F to +200°F

Applications/Markets



- Tractor to Trailer

Kit Coil Number	Individual Coil Part Number	Tube O.D.		Valve Tail Length		Brass Male Ends (NPT)				Working Length		Number of Coils
		inch	mm	inch	mm	Valve		Gladhand		feet	meter	
#	#	⊙										
		inch	mm	inch	mm	inch	mm	inch	mm	feet	meter	
731516	731512-Red 731512-Blue	-8	13	12	305	1/2	13	1/2	13	15	4.6	21-1/2
751597	731611-Red 731611-Blue	-8	13	12	305	3/8	10	1/2	13	15	4.6	21-1/2
731522	731513-Red 731513-Blue	-8	13	40	1016	1/2	13	1/2	13	15	4.6	21-1/2
741526	731612-Red 731612-Blue	-8	13	40	1016	3/8	10	1/2	13	15	4.6	21-1/2
751641	741590-Red 741590-Blue	-8	13	6	152	1/2	13	1/2	13	12	3.7	18-1/2
751655	751656-Blk Black Only	-8	13	6	152	3/8	10	1/2	13	12	3.7	18-1/2

Order Information

BRAKCOIL® kits are supplied complete – **Parker pre-assembled**, with everything needed, including spring guards and male pipe NTA brass fittings, **ready to install**. Special pipe thread sealant is factory applied. No cutting or assembly necessary. Just attach the gladhands (sold separately or pre-assembled). They are available in kits or as separate lines. A kit consists of both a red and blue tube assembly.

Construction

Tube: Coiled Nylon Air Brake Tubing

Operating Parameters

Temperature Range:
-70°F to +200°F (-57°C to +93°C)

Options

Extended BRAKCOIL handle available, part no. 771164

Gladhands available

- Blue - Part # GH9211
- Red - Part # GH9212

For detailed ordering information, please consult price list or contact Parflex® Division.

Parker Hannifin Corporation | Parflex® Division | Ravenna, Ohio | parker.com/pfd

www.comoso.com



A Hose
 B Tubing
 C Coiled Air Hose & Fittings
 D Transportation
 E Fittings
 F Tooling, Equipment & Accessories
 G General Technical

Duo-Coil™ Features



Features

- Duo-Coil combines both tractor-to-trailer lines (service and emergency) into a strong single unit
- Designed for quick hook-up and trouble-free service on your rig
- Reverse winding of the coiled air brake lines eliminates the possibility of tangling
- Installation swivel fittings make hook-up a snap
- The inner red emergency coil is wound inside the blue service coil offering added protection to the driver
- The single unit provides clean and neat installation

Certifications

- Meets or exceeds SAE J844 and D.O.T. FMVSS 106 Specifications at -70°F to +200°F

Applications/Markets



- Tractor to Trailer

Kit Coil Number	Tube O.D.		Valve Tail Length		Brass Male Ends (NPT)				Working Length		Number of Coils
					Valve		Gladhand				
#	⊙										
	inch	mm	inch	mm	inch	mm	inch	mm	feet	meter	
801048	-8	13	12	305	1/2	13	1/2	13	15	4.6	21-1/2
801632	-8	13	6	152	1/2	13	1/2	13	12	3.7	18-1/2
801595	-8	13	40	1016	1/2	13	1/2	13	15	4.6	21-1/2

Order Information

Duo-Coil™ kits are supplied complete – **Parker pre-assembled**, with everything needed, including spring guards and pipe end NTA fittings, **ready to install**. Special pipe thread sealant is factory applied. No cutting or fitting assembly is necessary. Just attach the gladhands (sold separately or pre-assembled).

Construction

Tube: Coiled Nylon Air Brake Tubing

Operating Parameters

Temperature Range:
-70°F to +200°F (-57°C to +93°C)

Options

Extended BRAKCOIL handle available, part no. 771164

Gladhands available

- Blue – Part # GH9211
- Red – Part # GH9212

DollyCoil™



Features

- No need to install springs or hangers
- Will retract to its original shape even after long periods of extended use

Certifications

- Meets or exceeds SAE J844 and D.O.T. FMVSS 106 Specifications at -70°F to +200°F

Applications/Markets



- Multiple Trailers
- Converter Dollies

Kit Coil Number	Tube O.D.		Valve Tail Length		Brass Male Ends (NPT)				Standard Working Length		Number of Coils
					Valve 90° End		Gladhand 180° End				
#	⊙										
	inch	mm	inch	mm	inch	mm	inch	mm	feet	meter	
751634	-8	13	8	13	1/2	13	1/2	13	6	1.83	12

Order Information

DollyCoil™ kits are supplied complete – **Parker pre-assembled**, with everything needed, including spring guards and male pipe end NTA fittings, **ready to install**. Special pipe thread sealant is factory applied. No cutting or assembly necessary. Just attach the gladhands (sold separately or pre-assembled). They are available in kits or as separate lines. A kit consists of both a red and blue tube assembly.

Construction

Tube: Coiled Nylon Air Brake Tubing

Operating Parameters

Temperature Range:
-70°F to +200°F (-57°C to +93°C)

Options

Extended BRAKCOIL handle available, part no. 771164

Gladhands available

- Blue – Part # GH9211
- Red – Part # GH9212

For detailed ordering information, please consult price list or contact Parflex® Division.

Parker Hannifin Corporation | Parflex® Division | Ravenna, Ohio | parker.com/pfd

www.comoso.com



D-9

A Hose

B Tubing

C Coiled Air Hose & Fittings

D Transportation

E Fittings

F Tooling, Equipment & Accessories

G General Technical

SliderCoil™



Features

- Used between an adjustable rear trailer axle and the final point on a trailer chassis
- No need to install springs or hangers
- Will retract to its original shape even after long periods of extended use

Certifications

- Meets or exceeds SAE J844 and D.O.T. FMVSS 106 Specifications at -70°F to +200°F

Applications/Markets



- Tractor Trailers (Sliding)
- Tractor Trailers (Axles)

Kit Coil Number	Individual Coil Part Number	Tube O.D.		Valve Tail Length		Brass Male Ends (NPT)				Working Length		Number of Coils
						Valve 90° End		Gladhand 180° End				
#	#											
		inch	mm	inch	mm	inch	mm	inch	mm	feet	meter	feet
751657	751658-BLU, RED	-8	13	8	13	1/4	6	1/4	6	13-1/2	4.1	9
751659	751660-BLU, RED	-8	13	8	13	3/8	10	3/8	10	13-1/2	4.1	9

Order Information

SliderCoil™ kits are supplied complete – **Parker pre-assembled**, with everything needed, including spring guards and male pipe end NTA fittings, **ready to install**. Special pipe thread sealant is factory applied. No cutting or assembly necessary. They are available in kits or as separate lines. A kit consists of both a red and blue coil assemblies.

Construction

Tube: Coiled Nylon Air Brake Tubing

Operating Parameters

Temperature Range: -70°F to +200°F (-57°C to +93°C)

Color

- Blue
- Red

Options

Extended BRAKCOIL handle available, part no. 771164

Fifth Wheel Slider Coil



Features

- Clutter-free hook-up and maintenance-free performance of adjustable length pneumatic tubing for fifth wheel sliding action
- Self-adjusts from 10" to fully extended 74" working length
- Universal, ready for immediate installation
- No maintenance required - stays on the job at peak performance through years of trouble-free life
- Coil set is strong and permanent - Even after prolonged use in fully extended position, coils will retract to shorter length without sagging and eliminating hazards of chafing and wear

Certifications

- Conforms to SAE Specification J844 Type A
- Meets D.O.T. FMVSS 106

Applications/Markets



- Double Trailers
- Covert, Dollies

Part Number	Fittings	Pigtail Length		Max. Extended Length		Retracted Length	
		inch	mm	inch	mm	inch	mm
#							
811537	(2)68NTA-4-4	2	51	74	1880	10	254
811537-NF-BLK	-	2	51	74	1880	10	254

Order Information

Fifth Wheel Slider Coil part# 811537 comes complete with fittings. Part# 811537-NF-BLK does not include fittings.

Construction

Tube: 1/4" O.D. extruded Nylon, heat and light stabilized, single wall

Operating Parameters

Temperature Range: -40°F to +200°F (-40°C to +93°C)

Color

- SIL

Options

Available with or without fittings

For detailed ordering information, please consult price list or contact Parflex® Division.

Parker Hannifin Corporation | Parflex® Division | Ravenna, Ohio | parker.com/pfd

www.comoso.com



D-11

A Hose

B Tubing

C Coiled Air Hose & Fittings

D Transportation

E Fittings

F Tooling, Equipment & Accessories

G General Technical

Custom Harness, Bundles & Tubing

Order Information

Several different harnesses may be required on a single unit depending upon the model of the vehicle, wheel base and options available. To determine your harness application needs:

- 1. Recognize the cost savings** available to you through the use of harnesses. How many dollars will be saved on tubing installation alone? On scrap reduction?
- 2. Call Parker.** Have one of our application engineers study your application.
- 3. Have Parker engineers design and build a prototype** harness for your approval.
- 4. Approve the prototype** as our basis to engineer your production model harness.
- 5. Implement the harness** into your Purchasing and Production systems – one harness, one part number instead of multiple part numbers you once had for each air brake line.

Features

- Preformed, pre-bundled tubing or hose custom designed to reduce installation time and improve throughput
- Your production line will run faster and be virtually free from tubing scrap
- Individual tubes are pre-cut and assembled into a single unit

Certifications

- Designed and engineered to meet the exacting requirements of each bus or truck manufacturer for each vehicle
- The air brake tubing used in a Parflex Harness conforms to SAE J844 type 3A and 3B and also D.O.T. FMVSS 106
- Parflex Division is third party certified for ISO 14001 and TS 16949
- 6mm Nylon, 5.5mm EPDM, and 4mm EPDM are IP6X, IPX8, and IPX9K Certified

Tubing

Construction

Tube: Nylon Air Brake Tubing

Operating Parameters

Temperature Range: -40°F to +200°F (-40°C to +93°C)

Working Pressure: 150 psi (10.3 bar)

Options

Each tube can be color-coded and/or numbered

Each harness may contain any number of tube sizes ranging from 1/8" O.D. to 3/4" O.D.

The harness can be supplied with special clamps, brackets and fittings to meet any need required by the customer

Hose

Contact Parflex Customer Service for custom formed hoses and hose assemblies



Cut Tubes

Any tube offered by Parflex can be cut-to-length, with options for additional marking



Formed Tubes

Tubes can be formed into shapes for ease of installation

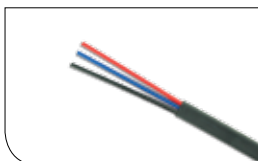

Jacketed Bundles

Two or more tubes can be bundled together with an extruded thermoplastic jacket

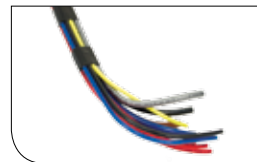

Straight Harnesses

Combine multiple cut tubes into a harness built specifically for your application



Formed Harnesses

Combine multiple formed tubes to create a repeatable tubing routing solution



Formed Assemblies

Most Parflex thermoplastic hoses can be formed into application specific shapes

SCR Hose Assemblies for Tier IV Compliance



Features

- Consistent thaw - more reliable than coolant heated lines
- Multiple options available to fit every application
- Protective Overmolding
 - Protection against water ingress and damage of electrical components
 - Bolsters fitting strength and impact resistance
- Corrugated heat shield offers abrasion and heat resistance
- Assembled and designed in USA

Certifications

- Parflex Division is third party certified for ISO 14001 and TS 16949
- 6mm Nylon, 5.5mm EPDM, and 4mm EPDM are IP6X, IPX8, and IPX9K Certified

Applications/Markets



With Electrically Heated SCR Hose Assemblies from Parker's Parflex Division, a cleaner exhaust system means a cleaner environment. Designed for heating and conveying DEF (Diesel Exhaust Fluid) throughout the SCR system on commercial vehicles, Parflex hoses are made to handle both on-road and off-road applications while helping you stay Tier IV and EPA '10 compliant. Combine these hoses with other high value Parflex fluid conveyance products (pilot lines, grease lines, hydraulic hoses, etc.) so your customer can enjoy best in class durability and performance.

All Parflex SCR hose assemblies have multiple options that allow customization by the equipment manufacturer and the end user

SCR hoses are available with several different options. These include, but are not limited to: different electrical connectors, including options for heat and abrasion shield over lead wires; 1/4, 5/16, and 3/8 fittings; wide variety of lengths; 12V or 24V; etc. Parflex also has designs for other sizes and core tubes for SCR hoses. These designs ensure that Parflex hoses can be utilized on SCR systems from multiple suppliers.

patents pending

Check www.scrhose.com for product updates

For detailed ordering information, please consult price list or contact Parflex® Division.

Parker Hannifin Corporation | Parflex® Division | Ravenna, Ohio | parker.com/pfd

www.comoso.com



D-13

A Hose

B Tubing

C Coiled Air Hose & Fittings

D Transportation

E Fittings

F Tooling, Equipment & Accessories

G General Technical

S0/S1/S2

Suction/Throttle Line Design



Parflex SCR Hose Assembly Polyamide Suction/Throttle Line

- Thermoplastic core tube with fabric reinforcement
- Extruded thermoplastic jacket
- Optional heat/abrasion shield

Certifications

- TS 16949
- ISO 14001

Base Part Number	Nominal I.D.		O.D.		with Shield (opt)		Max. Oper. Pressure		Min. Burst Pressure		Vacuum Resistance		Bend Radius		Standard Lengths*
	mm	inch	mm	inch	mm	inch	psi	bar	psi	bar	inch	Hg/bar	inch	mm	mtr
S0	6	.24	14	.55	21	.827	145	10	600	40	8.9	300m	2	51	1/2, 1, 1-1/2 or 2
S1	6	.24	14	.55	21	.827	145	10	600	40	8.9	300m	2	51	1/2, 1, 1-1/2 or 2

Operating Parameters

- Temperature Range: -40°F to 158°F (-40°C to 70°C)
Spikes to 221°F (105°C)
- Available in 12VDC or 24VDC design

Many custom options available, please contact Parflex for details.

S0 - No abrasion guard S1 - Abrasion guard, hose only S2 - Abrasion guard on hose and wire

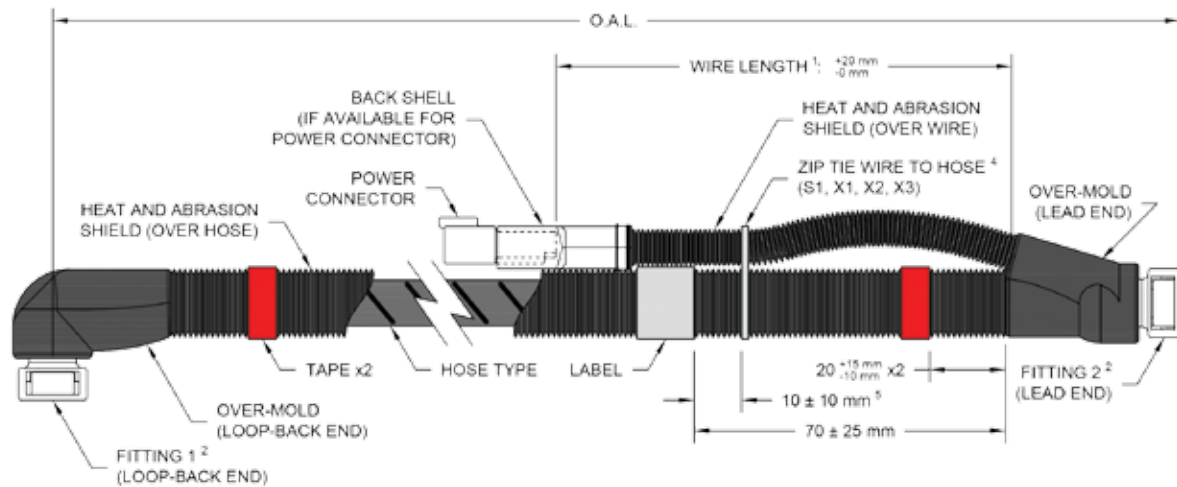

P1/P2

Polyamide Pressure Line Design



Parflex SCR Hose Assembly Polyamide Pressure Line

- Specialty high temperature polyamide
- core with fabric reinforcement
- Stainless steel heating wire
- Extruded high temperature thermoplastic jacket
- Heat/abrasion shield

Operating Parameters

- Temperature Range: -40°F to 248°F (-40°C to 120°C)
Spikes to 284°F (140°C)
- Internal/Fluid Temp: 140°F (60°C) Max., per Cummins AEB
- Available in 12VDC or 24VDC design

Base Part Number	I.D.		O.D.		with Shield (opt)		Max. Oper. Pressure		Min. Burst Pressure		Bend Radius		Standard Lengths*
	mm	inch	mm	inch	mm	inch	psi	bar	psi	bar	inch	mm	mtr
S0	6	.24	13	.51	21	.827	145	10	600	40	2	51	1/2, 1, 1.5, 2, 2.5, 3

Many custom options available, please contact Parflex for details.

P1 - Abrasion guard, hose only P2 - Abrasion guard on hose and wire

Hose Fittings



Permanent/Crimp

Field Attachable/Reusable



Table of Contents

Intro

Hose Fitting Nomenclature.....	E-3
Fitting Configurations by Connection and End Code	E-4

Permanent/Crimp

54 Series	E-8
55/58 Series	E-12
56 Series	E-36
57 Series	E-58
58H Series	E-61
91N/91 Series	E-72
92 Series	E-85
93N Series	E-87
94/95 Series	E-90
PAGE Fittings	E-91
CY Series	E-101
SF Series	E-105
HY Series	E-107
LV Series	E-124
MS Series	E-125
SQ Series	E-127

Field Attachable/Reuseable

51 Series	E-5
90 Series	E-65
BA Series	E-99
BU Series	E-100
MS Series	E-125



Parflex Fittings

Parflex has expanded the Fitting Section to include the new, Global 56 Series.

Shorter and more compact than 55/58 Series

- Weight reduction up to 20%
- Easier handling/installation in tight installation areas
- Short length may allow use of hose routing to replace current elbow fittings

Faster & easier hose crimping

- Full length crimp of the sleeve (no marking of crimp length needed), therefore easier, safer and faster crimping vs. 55 series

Parker Legacy Fitting Nomenclature

Example: 10356-8-6

This example describes a permanent crimp 1/2" Male JIC 37° with a 3/8" I.D. hose size. This fitting is constructed of steel since the designated material is blank.

- 10356-8-6** – **Fitting Type** (1 = Permanent/Crimp
2 = Field Attachable Fitting)
- 10356-8-6** – **End Configuration Code** (Male JIC 37°)
- 10356-8-6** – **Fitting Series** (Series 56)
- 10356-8-6** – **End Size** (1/2")
- 10356-8-6** – **Hose I.D.** (3/8")
- 10356-8-6C** – **Alternate Material**

Fitting part numbers that start with a "2" are field attachable fittings

Legacy Fitting Material Selection

- Blank = Steel (unless otherwise noted)
- B = All Brass
- C = Stainless Steel
- S = All Carbon Steel – Used only with PTFE Fittings

Current 55 series dies are qualified and can be used with the 56 series

Consolidation of 2 series into one

- (55 and 58 = 56) thus reducing the customer inventory
- Easy to choose product range
- Global fitting series/Global availability
- Global part numbering with metric & inch hex and end connections

PAGE Fitting Nomenclature

Example: 08-16SAN-S

This example describes a permanent sanitary flange step down, 1/2" I.D. hose with a 1" sanitary flange. This fitting is constructed of stainless steel since the designated material is -S.

As demonstrated below, the nomenclature associated with the PAGE fitting is not consistent with the traditional Parker products, as the end size and hose I.D. are reversed and located at the front of the part construction.

- 08-16SAN-S** – **Hose I.D.** (1/2")
- 08-16SAN-S** – **End Size** (1")
- 08-16SAN-S** – **End Configuration Code**
(Sanitary Flange)

PAGE Fitting Material Selection

- B = All Brass
- C = Carbon Steel
- S = Stainless Steel

NOTE: The PAGE fittings, which are designed for use with traditional PAGE fluoropolymer hoses only, are a two piece crimp connection and need to be combined with the corresponding crimp collars located on page E-92.

For detailed ordering information, please consult price list or contact Parflex® Division.

Parker Hannifin Corporation | Parflex® Division | Ravenna, Ohio | parker.com/pfd

www.comoso.com



E-3

A
Hose

B
Tubing

C
Coiled Air Hose
& Fittings

D
Transportation

E
Fittings

F
Tooling, Equipment
& Accessories

G
General Technical

Standard Fitting Configurations by Connection and End Code

	Description	End Code	
Pipe	Male NPTF Pipe - Rigid - Straight	01	
	Male NPTF Pipe - Swivel - Straight	13	
	Male NPTF Pipe - Swivel - 90° Elbow	1L	
	Female NPTF Pipe - Rigid - Straight	02	
	Female NPSM Pipe - Swivel - Straight (60° Cone)	07	
SAE Str. Trd.	Male SAE Straight Thread with O-ring - Rigid - Straight	05	
	Male SAE Straight Thread with O-ring - Swivel - Straight	0G	
	Male SAE Straight Thread with O-ring - Swivel - 90° Elbow	0L	
	Male SAE Straight Thread with O-ring - Adjustable - 90° Elbow	35	
Flare	Male JIC 37° - Rigid - Straight	03	
	Male JIC 37° - Bulkhead without Locknut - Straight	LB	
	Female JIC 37° - Swivel - Straight	06	
	Female JIC 37° - Swivel - 45° Elbow - Short Drop	37	
	Female JIC 37° - Swivel - 45° Elbow - Medium Drop	L7	
	Female JIC 37° - Swivel - 90° Elbow - Short Drop	39	
	Female JIC 37° - Swivel - 90° Elbow - Medium Drop	L9	
	Female JIC 37° - Swivel - 90° Elbow - Long Drop	41	
	Male SAE 45° - Rigid - Straight	04	
	Female SAE 45° - Swivel - Straight	08	
	Female SAE 45 / Swivel - 45° Elbow	77	
	Female SAE 45 / Swivel - 90° Elbow	79	
	Female SAE 45 / Swivel - 90° Elbow - Long Drop	81	
	Female JIC 37°/SAE 45° Dual Flare - Swivel - Straight	06	
	Inverted Flare	Male Inverted SAE 45° - Swivel - Straight	28
		Male Inverted SAE 45° - Swivel - 45° Elbow	67
		Male Inverted SAE 45° - Swivel - 90° Elbow	69
Female Inverted SAE 45° - Rigid - Straight		29	
Seal-Lok	Male Seal-Lok - Rigid - Straight (with O-ring)	J0	
	Male Seal-Lok - Bulkhead without Locknut-Straight (with O-ring)	JB	
	Female Seal-Lok - Swivel - Straight - Long	JS	
	Female Seal-Lok - Swivel - Straight - Short	JC	
	Female Seal-Lok - Swivel - 30° Elbow	J2	
	Female Seal-Lok - Swivel - 22 1/2° Elbow	J6	
	Female Seal-Lok - Swivel - 45° Elbow	J7	
	Female Seal-Lok - Swivel - 90° Elbow - Short Drop	J9	
	Female Seal-Lok - Swivel - 90° Elbow - Medium Drop	J5	
	Female Seal-Lok - Swivel - 90° Elbow - Long Drop	J1	
JIS	Female Metric Swivel - Straight (30° Flare)	MU	
	Female BSP Parallel Pipe - Swivel - Straight (30° Flare)	FU	
	Male BSP Taper Pipe - Rigid - Straight (60° Cone)	UT	
	Female BSP Parallel Pipe - Swivel - Straight (60° Cone)	GU	
	Female BSP Parallel Pipe - Swivel - 45° Elbow (60° Cone)	G1	
Metric	Female BSP Parallel Pipe - Swivel - 90° Elbow (60° Cone)	G2	
	Male Metric L - Rigid - Straight (24° Cone)	D0	
	Male Standpipe Metric L - Rigid - Straight	1D	

	Description	End Code
Metric	Female Metric L - Swivel - Straight (Ball Nose)	C3
	Female Metric L - Swivel - 45° Elbow (Ball Nose)	C4
	Female Metric L - Swivel - 90° Elbow (Ball Nose)	C5
	Female Metric L - Swivel - Straight (24° Cone with O-ring)	CA
	Female Metric L - Swivel - 45° Elbow (24° Cone with O-ring)	CE
	Female Metric L - Swivel - 90° Elbow (24° Cone with O-ring) -	CF
	Male Metric S - Rigid - Straight (24° Cone)	D2
	Male Standpipe Metric S - Rigid - Straight	3D
	Female Metric S - Swivel - Straight (Ball Nose)	C6
	Female Metric S - Swivel - 45° Elbow (Ball Nose)	C7
BSP	Female Metric S - Swivel - 90° Elbow (Ball Nose)	C8
	Female Metric S - Swivel - Straight (24° Cone with O-ring)	C9
	Female Metric S - Swivel - 45° Elbow (24° Cone with O-ring)	0C
	Female Metric S - Swivel - 90° Elbow (24° Cone with O-ring)	1C
	Male BSP Taper Pipe - Rigid - Straight	91
	Female BSP Parallel Pipe - Swivel - Straight (60° Cone)	92
	Male BSP Parallel Pipe - Rigid - Straight (60° Cone)	D9
	Female BSP Parallel Pipe - Swivel - 45° Elbow (60° Cone)	B1
	Female BSP Parallel Pipe - Swivel - 90° Elbow (60° Cone)	B2
	Female BSP Parallel Pipe - Swivel - 90° Elbow Block Type (60° Cone)	B4
Fr. Gaz	Female BSP Parallel Pipe - Swivel - Straight (Flat Seat)	B5
	Male BSP Taper Pipe - Rigid - 45° Elbow	BV
	Male BSP Taper Pipe - Rigid - 90° Elbow or Side Outlet	BZ
	Male French Gaz Series - Rigid - Straight (24° Cone)	FG
	Female French Gaz Series - Swivel - Straight (Ball Nose)	F4
	Male Ferulok Flareless-Rigid-Straight (24° Cone with Nut & Ferrule)	11
	Female Ferulok Flareless - Swivel - Straight (24° Cone)	12
	DIN Metric Banjo - Straight	49
	ANSI B16.5 Flange	4K
	Female A-Lok® Compression	AL
Specialty	Female Cam & Groove	FC
	Sanitary Flange & Step Downs	FN
	Mini Sanitary Flange	FV
	Bulkhead w/Zerk Port Integrated	GK
	Male I-Line® Sanitary	H1
	Female I-Line® Sanitary	H2
	Male Sanitary Bevel Seat	H4
	Female Sanitary Bevel Seat	H5
	Male Standpipe - Rigid - Straight (Inch Size Tube O.D.)	34
	Male Standpipe - Rigid - Straight with V-Notch	TW
General	Universal Tube Stub	TU
	Male Rapid Assembly, Straight	WU
	Male Rapid Assembly, 45° Elbow	WW
	Male Rapid Assembly, 90° Elbow	WY





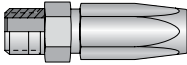
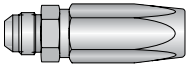
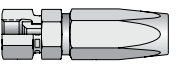
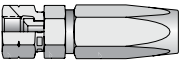
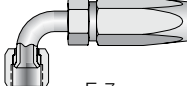

For detailed ordering information, please consult price list or contact Parflex® Division.

51 Series Visual Index

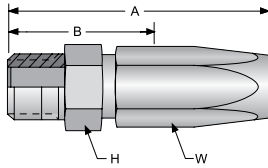
51 Series FIELD ATTACHABLE	201	Male Taper Pipe Rigid	203	Male [JIC] 37°	206	SAE [JIC] 37° Swivel	208	SAE 45° Swivel	239	[JIC] 37° Swivel 90° Elbow
										
	E-5		E-6		E-6		E-7		E-7	

20151 Male Taper Pipe Rigid



Part Number	Thread Size	Hose I.D.		A		Cutoff Allow. B		H Hex	W Hex
		inch	mm	inch	mm	inch	mm	inch	inch
#									
20151-2-3	1/8-27	3/16	5	1.71	43	1	25	7/16	5/8
20151-4-3	1/4-18	3/16	5	1.90	48	1-1/8	29	9/16	5/8
20151-2-4	1/8-27	1/4	6	1.90	48	1	25	1/2	5/8
20151-4-4	1/4-18	1/4	6	2.08	53	1-3/16	30	9/16	5/8
20151-4-5	1/4-18	5/16	8	2.17	55	1-7/16	37	9/16	3/4
20151-6-5	3/8-18	5/16	8	2.17	55	1-7/16	37	3/4	3/4
20151-4-6	1/4-18	3/8	10	2.61	66	1-7/16	37	3/4	7/8
20151-6-6	3/8-18	3/8	10	2.61	66	1-7/16	37	3/4	7/8
20151-8-6	1/2-14	3/8	10	2.80	71	1-9/16	40	7/8	7/8
20151-6-8	3/8-18	1/2	13	2.99	76	1-1/2	38	7/8	1-1/16
20151-8-8	1/2-14	1/2	13	3.17	81	1-11/16	43	7/8	1-1/16
20151-12-12	3/4-14	3/4	19	3.42	87	1-3/4	44	1-1/8	1-3/8
20151-16-16	1-11-1/2	1	25	3.74	95	2-1/4	57	1-3/8	1-9/16

Construction: Steel.
Add "C" for Stainless Steel.

51 series field attachable couplings are not intended for use on hose that has previously been in service.

For detailed ordering information, please consult price list or contact Parflex® Division.

Parker Hannifin Corporation | Parflex® Division | Ravenna, Ohio | parker.com/pfd

www.comoso.com

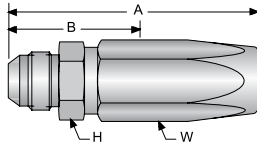

A Hose
 B Tubing
 C Coiled Air Hose & Fittings
 D Transportation
 E Fittings Series 5-1
 F Tooling, Equipment & Accessories
 G General Technical

A
Hose**20351 Male (JIC) 37° - Rigid**

Part Number	Thread Size	Hose I.D.		A		Cutoff Allow. B		H Hex	W Hex
		inch	mm	inch	mm	inch	mm	inch	inch
#									
20351-4-3	7/16-20	3/16	5	1.88	48	1-1/8	29	1/2	5/8
20351-5-4	1/2-20	1/4	6	2.06	52	1-1/8	29	9/16	5/8
20351-6-5	9/16-18	5/16	8	2.16	55	1-5/16	33	5/8	3/4
20351-6-6	9/16-18	3/8	10	2.61	66	1-7/16	37	3/4	7/8
20351-8-6	3/4-16	3/8	10	2.71	69	1-7/16	37	13/16	7/8
20351-8-8	3/4-16	1/2	13	3.08	78	1-5/8	41	7/8	1-1/16

Construction: Steel.

Add "C" for Stainless Steel.

B
TubingC
Coiled Air Hose
& Fittings

51 series field attachable couplings are not intended for use on hose that has previously been in service.

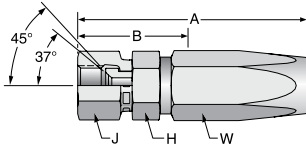
D
Transportation**20651 SAE (JIC) 37° Swivel**

Part Number	Thread Size	Hose I.D.		A		Cutoff Allow. B		H Hex	J Hex	W Hex
		inch	mm	inch	mm	inch	mm	inch	inch	inch
#										
20651-4-3	7/16-20	3/16	5	1.99	51	1-1/4	32	9/16	9/16	5/8
20651-4-4	7/16-20	1/4	6	2.18	55	1-1/4	32	9/16	9/16	5/8
20651-5-4	1/2-20	1/4	6	2.24	57	1-7/16	37	5/8	5/8	5/8
20651-6-4	9/16-18	1/4	6	2.34	59	1-7/16	37	11/16	11/16	5/8
20651-6-5	9/16-18	5/16	8	2.37	60	1-1/2	38	11/16	11/16	3/4
20651-6-6	9/16-18	3/8	10	2.74	70	1-7/16	37	11/16	11/16	7/8
20651-8-6	3/4-16	3/8	10	2.88	73	1-5/8	41	7/8	7/8	7/8
20651-8-8	3/4-16	1/2	13	3.25	83	1-3/4	44	7/8	7/8	1-1/16
20651-10-8	7/8-14	1/2	13	3.37	86	1-7/8	48	1	1	1-1/16
20651-12-12	1-1/16-12	3/4	19	3.75	95	2-1/8	54	1-1/4	1-1/4	1-3/8
20651-16-16	1/5/16-12	1	25	3.93	100	2-7/16	62	1-1/2	1-1/2	1-9/16

Construction: Steel.

Add "C" for Stainless Steel.

E
Fittings
Series 51F
Tooling, Equipment
& AccessoriesG
General Technical

20851 SAE 45° Swivel

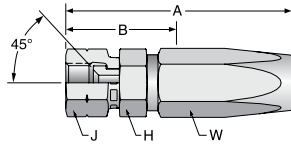

Part Number	Thread Size	Hose I.D.		A		Cutoff Allow. B		H Hex	J Hex	W Hex
		inch	mm	inch	mm	inch	mm	inch	inch	inch
#										
20851-6-6	5/8-18	3/8	10	2.82	72	1-9/16	40	3/4	3/4	7/8

Construction: Steel.

Add "C" for Stainless Steel.

51 series field attachable couplings are not intended for use on hose that has previously been in service.

23951 JIC 37° Swivel 90° Elbow Short Drop

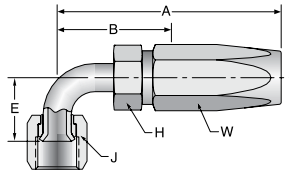

Part Number	Thread Size	Hose I.D.		A		Cutoff Allow. B		E		H Hex	J Hex	W Hex
		inch	mm	inch	mm	inch	mm	inch	mm	inch	inch	inch
#												
23951-4-3	7/16-20	3/16	5	1.77	45	1	25	0.83	21	3/8	9/16	5/8
23951-6-6	9/16-18	3/8	10	2.70	69	1-7/16	37	0.85	22	9/16	11/16	7/8
23951-8-6	3/4-16	3/8	10	2.90	74	1-5/8	41	1.09	28	11/16	7/8	7/8

Construction: Steel.

Add "C" for Stainless Steel.

For detailed ordering information, please consult price list or contact Parflex® Division.

Parker Hannifin Corporation | Parflex® Division | Ravenna, Ohio | parker.com/pfd

www.comoso.com



A Hose
 B Tubing
 C Coiled Air Hose & Fittings
 D Transportation
 E Fittings Series 5-1
 F Tooling, Equipment & Accessories
 G General Technical

A Hose

54 Series Visual Index

B Tubing

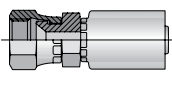
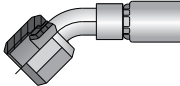
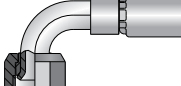
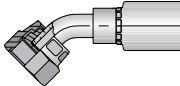
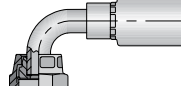
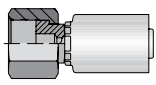
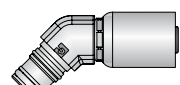
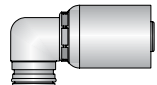
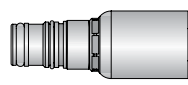
54 Series PERMANENT	106 Female SAE (JIC) 37° Swivel  E-9	137 Female (JIC) 37° Swl, 45° Elbow  E-10	139 Female (JIC) 37° Swl, 90° Elbow  E-10	1J7 Female Seal-Lok™ 45° Elbow  E-9	1J9 Female Seal-Lok™ 90° Elbow  E-9
	1JC Female Seal-Lok™ Str. Short O-ring  E-8	1WW Male Rapid Assembly, 45° Elb.  E-10	1WY Male Rapid Assembly, 90° Elb.  E-11	1WU Male Rapid Assembly, Straight  E-11	

C Coiled Air Hose & Fittings

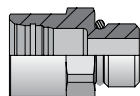

54 Series Adapter PERMANENT	685RA Female Rapid Assy. Adapter Male SAE  E-11
--	---

D Transportation

E Fittings Series 54

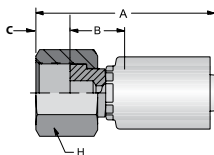
1JC54 Female Seal-Lok™ Straight Short O-ring Face Seal ISO 12151-1 SWSA



Part Number	Thread Size	Hose I.D.		A		Cutoff Allow. B		C		H Hex
		inch	mm	inch	mm	inch	mm	inch	mm	inch
#										
1JC54-4-4	9/16-18	1/4	6	1.38	35	5/8	16	.32	8	11/16
1JC54-6-6	11/16-16	3/8	10	1.58	40	9/16	14	.32	8	13/16

Construction: Steel.
Add "C" for Stainless Steel

F Tooling, Equipment & Accessories

G General Technical



1J754 Female Seal-Lok™ 45° Elbow O-ring Face Seal

ISO 12151-1 SWE45

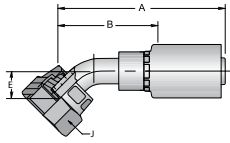

Part Number	Thread Size	Hose I.D.		A		Cutoff Allow. B		E		J Hex
		inch	mm	inch	mm	inch	mm	inch	mm	inch
#										
1J754-4-4	9/16-18	1/4	6	2.16	55	1-3/8	35	0.41	10	11/16

Construction: Steel.

Add "C" for Stainless Steel.

1J954 Female Seal-Lok™ 90° Elbow O-ring Face Seal Short Drop

ISO 12151-1 SWES90

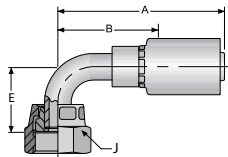

Part Number	Thread Size	Hose I.D.		A		Cutoff Allow. B		E		J Hex
		inch	mm	inch	mm	inch	mm	inch	mm	inch
#										
1J954-4-4	9/16-18	1/4	6	2.14	54	1-3/8	35	0.83	21	11/16
1J954-6-6	11/16-16	3/8	10	2.32	59	1-3/8	35	0.90	23	13/16

Construction: Steel.

Add "C" for Stainless Steel.

10654 Female SAE (JIC) 37° Swivel

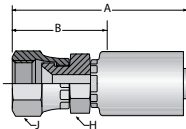

Part Number	Thread Size	Hose I.D.		A		Cutoff Allow. B		H Hex	J Hex
		inch	mm	inch	mm	inch	mm	inch	inch
#									
10654-4-4	7/16-20	1/4	6	1.75	45	1	25	9/16	9/16
10654-6-6	9/16-18	3/8	10	2.13	54	1-3/16	30	11/16	11/16

Construction: Steel.

Add "C" for Stainless Steel.

For detailed ordering information, please consult price list or contact Parflex® Division.

Parker Hannifin Corporation | Parflex® Division | Ravenna, Ohio | parker.com/pfd

www.comoso.com



E-9

Hose
A

Tubing
B

Coiled Air Hose
& Fittings
C

Transportation
D

Fittings
Series 5-4
E

Tooling, Equipment
& Accessories
F

General Technical
G

A Hose

13754 Female JIC 37° Swivel 45° Elbow

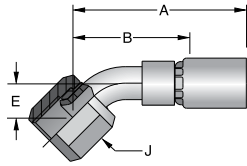

Part Number	Thread Size	Hose I.D.		A		Cutoff Allow. B		E		J Hex
		inch	mm	inch	mm	inch	mm	inch	mm	inch
#										
13754-4-4	7/16-20	1/4	6	2.08	53	1-1/4	32	.33	8	9/16

Construction: Steel.

Add "C" for Stainless Steel.

B Tubing

C Coiled Air Hose & Fittings

13954 Female JIC 37° Swivel 90° Elbow Short Drop

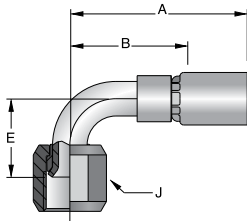

Part Number	Thread Size	Hose I.D.		A		Cutoff Allow. B		E		J Hex
		inch	mm	inch	mm	inch	mm	inch	mm	inch
#										
13954-4-4	7/16-20	1/4	6	1.97	50	1-3/16	30	.68	17	9/16
13954-6-6	9/16-18	3/8	10	2.30	59	1-5/8	41	.85	22	11/16

Construction: Steel.

Add "C" for Stainless Steel.

D Transportation

E Fittings Series 54

1WW54 Male Rapid Assembly - 45° Elbow

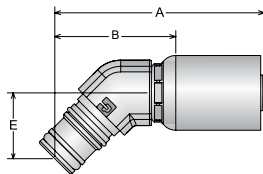

Part Number	Stem O.D.		Hose I.D.		A		Cutoff Allow. B		E	
	inch	mm	inch	mm	inch	mm	inch	mm	inch	mm
#										
1WW54-4-4	1/4	6	1/4	6	1.97	50	1-3/16	30	.67	17
1WW54-6-6	3/8	10	3/8	10	2.19	56	1-3/16	30	.69	18

Construction: Brass nipple, steel plated shell, Nitrile O-ring.

NOTE: Use with mating adapter PN 685RA.

F Tooling, Equipment & Accessories

G General Technical



1WY54 Male Rapid Assembly - 90° Elbow

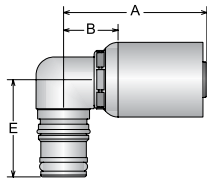

Part Number	Stem O.D.		Hose I.D.		A		Cutoff Allow. B		E	
	inch	mm	inch	mm	inch	mm	inch	mm	inch	mm
#										
1WY54-4-4	1/4	6	1/4	6	1.27	32	1/2	13	.90	23
1WY54-6-6	3/8	10	3/8	10	1.49	38	1/2	13	1.00	25

Construction: Brass nipple, steel plated shell, Nitrile O-ring.

NOTE: Use with mating adapter PN 685RA.

1WU54 Male Rapid Assembly - Straight

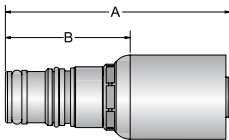

Part Number	Stem O.D.		Hose I.D.		A		Cutoff Allow. B	
	inch	mm	inch	mm	inch	mm	inch	mm
#								
1WU54-4-4	1/4	6	1/4	6	1.85	47	1-1/16	27
1WU54-6-6	3/8	10	3/8	10	2.13	54	1-1/8	29

Construction: Brass nipple, steel plated shell, Nitrile O-ring.

NOTE: Use with mating adapter PN 685RA.

685RA Adapter Female Rapid Assembly - Male SAE Straight Thread ORB

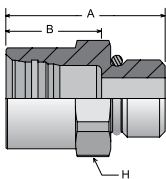

Part Number	Stem O.D.		Thread Size	A		H Hex
	inch	mm		inch	mm	inch
#						
685RA-4-4	1/4	6	7/16-20	1.05	27	11/16
685RA-6-4	3/8	10	7/16-20	1.15	29	3/4
685RA-4-6	1/4	6	9/16-18	1.12	28	3/4
685RA-6-6	3/8	10	9/16-18	1.15	29	3/4

Construction: Brass nipple, Nitrile O-ring.

NOTE: Use with mating fittings 1WU54, 1WW54, 1WY54.

For detailed ordering information, please consult price list or contact Parflex® Division.





Parker Hannifin Corporation | Parflex® Division | Ravenna, Ohio | parker.com/pfd

www.comoso.com

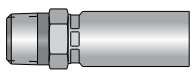
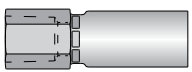
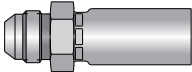
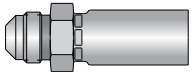
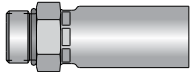
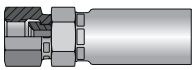
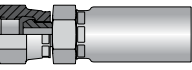
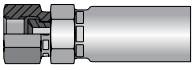
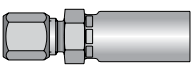
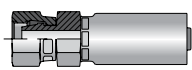
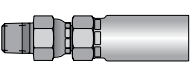
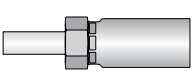

A Hose
 B Tubing
 C Coiled Air Hose & Fittings
 D Transportation
 E Fittings Series 54
 F Tooling, Equipment & Accessories
 G General Technical

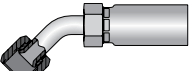
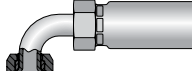
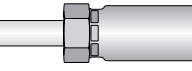
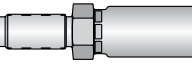
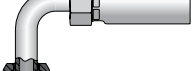
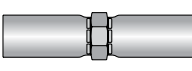
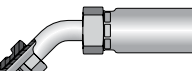
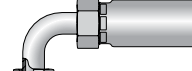
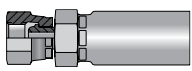
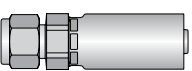
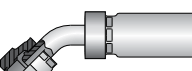
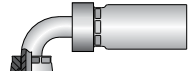
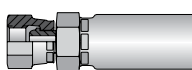
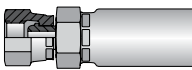
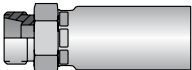
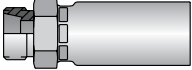
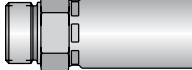
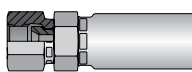
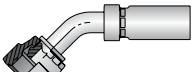
55/58 Series Visual Index

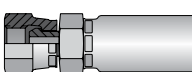
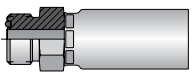
55/58 Series PERMANENT	101 Male Taper Pipe Rigid	102 Female Taper Pipe Rigid	103 Male (JIC) 37°	104 Male SAE 45°	105 Male Str. Thread O-ring
	 E-13	 E-14	 E-14	 E-15	 E-16
	106 SAE (JIC) 37° Swivel	107 Female Pipe Swivel	108 Female SAE 45° Swivel	111 Ferrul-Fix	112 SAE Flareless Swivel
	 E-16	 E-17	 E-17	 E-18	 E-18
	113 Male Pipe Swivel	11D Standpipe Light	11L Male Pipe Swivel 90° Elbow	137 FM JIC 37° Swivel 45° Elbow	139 FM JIC 37° Swivel 90° Elbow
	 E-19	METRIC  E-33	 E-19	 E-20	 E-21
	13D Standpipe Heavy	13E Male (JIC) 37° Long	141 FM JIC 37° Swivel 90° Lg Elbow	155 Hose Splicer	167 SAE Male Inverted 45° Elbow
	METRIC  E-34	 E-15	 E-22	 E-23	 E-23
	169 SAE Male Inverted 90° Elbow	192 Female BSP Pipe Swivel - Str. (60° Cone)	1AL A-Lok® Compression	1B1 Female BSP Pipe Swivel 45° Elb. (60° Cone)	1B2 Female BSP Pipe Swivel 90° Elb. (60° Cone)
	 E-24	 E-34	 E-28	 E-35	 E-35
	1C6 Female Swivel DIN 20078 HW w/o O-ring	1C9 Female Swivel DIN 20078 HW O-ring	1D0 Male Stud DIN 20078 Light	1D2 Male Stud DIN 20078 Heavy	1D9 Male BSPP
	METRIC  E-31	METRIC  E-31	METRIC  E-32	METRIC  E-32	METRIC  E-33
	1FU (JIS)/BSP 30° Flare Female Swivel	1G1 (JIS)/BSP 60° Cone FM Swivel 45° Elb.	1G2 (JIS)/BSP 60° Cone FM Swivel 90° Elb.	1GU (JIS)/BSP 60° Cone Female Swivel	1J0 Male Seal-Lok™ Rigid Str. w/O-ring
	 E-29	 E-30	 E-30	 E-29	 E-25



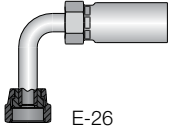
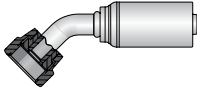
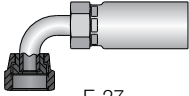
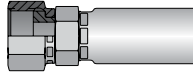
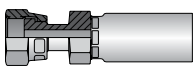
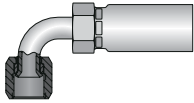
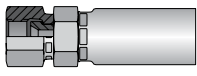
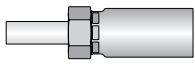
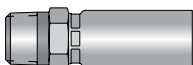

A Hose
 B Tubing
 C Coiled Air Hose & Fittings
 D Transportation
 E Fittings Series 55/58
 F Tooling, Equipment & Accessories
 G General Technical

55/58 Series PERMANENT	1J1 Female Seal-Lok™ 90° Elbow Long	1J7 Female Seal-Lok™ 45° Elbow	1J9 Female Seal-Lok™ 90° Elbow Short	1JC Female Seal-Lok™ Straight Short	1JS Female Seal-Lok™ Straight
	 E-26	 E-26	 E-27	 E-25	 E-24
	1L9 FM JIC 37° Swivel 90° Elbow, SPL Drop	1MU (JIS) Metric 30° Flare Female Swivel	1TU Universal Tube Stub End	1UT Male (JIS)/BSPT	
 E-22	METRIC  E-29	 E-27	 E-28		

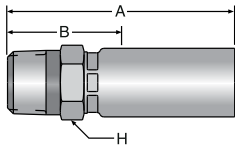
10155/10158 Male Taper Pipe Rigid



Part Number	Part Number	Thread Size	Hose I.D.		A		Cutoff Allow. B		H Hex
#	#								
55 Series	58 Series		inch	mm	inch	mm	inch	mm	inch
10155-2-3	—	1/8-27	3/16	5	1.94	49	1	25	9/16
10155-2-4	10158-2-4	1/8-27	1/4	6	2.13	54	1	25	5/8
10155-4-3	—	1/4-18	3/16	5	2.12	54	1-3/16	30	11/16
10155-4-4	10158-4-4	1/4-18	1/4	6	2.31	59	1-3/16	30	11/16
10155-4-5	—	1/4-18	5/16	8	2.37	60	1-3/16	30	11/16
10155-4-6	10158-4-6	1/4-18	3/8	10	2.66	68	1-5/16	33	3/4
10155-6-3	—	3/8-18	3/16	5	2.21	56	1-3/16	30	3/4
10155-6-4	10158-6-4	3/8-18	1/4	6	2.41	61	1-5/16	33	3/4
10155-6-5	—	3/8-18	5/16	8	2.47	63	1-5/16	33	3/4
10155-6-6	10158-6-6	3/8-18	3/8	10	2.66	68	1-5/16	33	3/4
10155-6-8	10158-6-8	3/8-18	1/2	13	2.85	72	1-5/16	33	7/8
10155-8-6	10158-8-6	1/2-14	3/8	10	2.91	74	1-9/16	40	15/16
10155-8-8	10158-8-8	1/2-14	1/2	13	3.09	78	1-9/16	40	15/16
10155-8-10	10158-8-10	1/2-14	5/8	16	3.20	81	1-1/2	38	1
10155-12-10	—	3/4-14	5/8	16	3.20	81	1-1/2	38	1-1/8
10155-12-12	10158-12-12	3/4-14	3/4	19	3.29	84	1-9/16	40	1-1/8
10155-16-16	10158-16-16	1-11-1/2	1	25	3.97	101	1-3/4	44	1-3/8

Construction: Steel.
 Add "B" for Brass.
 Add "C" for Stainless Steel.

For detailed ordering information, please consult price list or contact Parflex® Division.



A Hose
 B Tubing
 C Coiled Air Hose & Fittings
 D Transportation
 E Fittings Series 55/58
 F Tooling, Equipment & Accessories
 G General Technical

A Hose

10255/10258 Female Taper Pipe Rigid

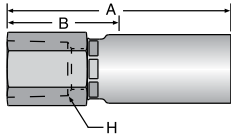

Part Number	Part Number	Thread Size	Hose I.D.		A		Cutoff Allow. B		H Hex
			inch	mm	inch	mm	inch	mm	inch
#	#								
55 Series	58 Series		inch	mm	inch	mm	inch	mm	inch
10255-4-4	10258-4-4	1/4-18	1/4	6	2.39	61	1-1/4	32	3/4
10255-6-4	—	3/8-18	1/4	6	2.60	66	1-1/2	38	7/8
10255-6-6	10258-6-6	3/8-18	3/8	10	2.84	72	1-1/2	38	7/8
10255-8-6	—	1/2-14	3/8	10	2.87	73	1-3/8	35	1-1/16
10255-8-8	10258-8-8	1/2-14	1/2	13	2.87	73	1-3/8	35	1-1/16

Construction: Steel.
 Add "B" for Brass.
 Add "C" for Stainless Steel.

B Tubing

C Coiled Air Hose & Fittings

10355/10358 Male (JIC) 37° - Rigid

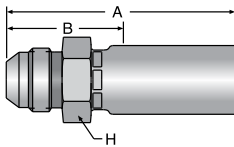

Part Number	Part Number	Thread Size	Hose I.D.		A		Cutoff Allow. B		H Hex
			inch	mm	inch	mm	inch	mm	inch
#	#								
55 Series	58 Series		inch	mm	inch	mm	inch	mm	inch
10355-4-3	—	7/16-20	3/16	5	2.17	55	1-3/16	30	9/16
10355-4-4	10358-4-4	7/16-20	1/4	6	2.31	58	1-3/16	30	5/8
10355-5-4	—	1/2-20	1/4	6	2.30	58	1-3/16	30	5/8
10355-5-5	—	1/2-20	5/16	8	2.30	58	1-3/16	30	5/8
10355-6-4	—	9/16-18	1/4	6	2.30	58	1-3/16	30	11/16
10355-6-5	—	9/16-18	5/16	8	2.30	58	1-3/16	30	11/16
10355-6-6	10358-6-6	9/16-18	3/8	10	2.65	67	1-1/4	32	3/4
10355-8-6	10358-8-6	3/4-16	3/8	10	2.68	68	1-3/8	35	13/16
10355-8-8	10358-8-8	3/4-16	1/2	13	2.87	73	1-3/8	35	7/8
10355-8-10	10358-8-10	3/4-16	5/8	16	3.10	79	1-7/16	36	1
10355-10-8	10358-10-8	7/8-14	1/2	13	3.03	77	1-9/16	40	15/16
—	10358-10-10	7/8-14	5/8	16	3.20	81	1-9/16	40	1
10355-12-10	10358-12-10	1-1/16-12	5/8	16	3.31	84	1-5/8	41	1-1/8
10355-12-12	10358-12-12	1-1/16-12	3/4	19	3.32	84	1-11/16	43	1-1/8
10355-16-16	10358-16-16	1-5/16-12	1	25	3.93	100	1-3/4	44	1-3/8

Construction: Steel.
 Add "B" for Brass.
 Add "C" for Stainless Steel.

D Transportation

E Fittings Series 55/58

F Tooling, Equipment & Accessories

G General Technical



13E55/13E58 Male (JIC) 37° Long

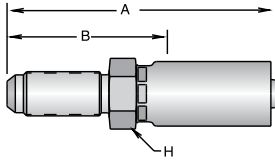

Part Number	Part Number	Thread Size	Hose I.D.		A		Cutoff Allow. B		H Hex
			inch	mm	inch	mm	inch	mm	inch
#	#								
55 Series	58 Series		inch	mm	inch	mm	inch	mm	inch
13E55-4-4	—	7/16-20	1/4	6	2.93	74	1-13/16	46	5/8
13E55-6-6	—	9/16-18	3/8	10	3.38	86	2	51	3/4
13E55-8-8	—	3/4-16	1/2	13	3.72	95	2-1/8	54	7/8

Construction: Steel.

Add "B" for Brass.

Add "C" for Stainless Steel.

NOTE: Bulkhead Locknut sold separately. WLN Locknuts are Manufactured by the Tube Fittings Division. Refer to Catalog 4300 for additional information.

10455/10458 Male SAE 45° - Rigid

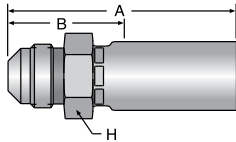

Part Number	Part Number	Thread Size	Hose I.D.		A		Cutoff Allow. B		H Hex
			inch	mm	inch	mm	inch	mm	inch
#	#								
55 Series	58 Series		inch	mm	inch	mm	inch	mm	inch
10455-4-3	—	7/16-20	3/16	5	2.06	52	1-1/8	29	9/16
10455-5-4	—	1/2-20	1/4	6	2.34	59	1-1/8	29	5/8
10455-6-5	—	5/8-18	5/16	8	2.55	65	1-1/4	32	3/4
10455-6-6	10458-6-6	5/8-18	3/8	10	2.74	70	1-1/4	32	3/4
10455-6-8	—	5/8-18	1/2	13	2.90	74	1-1/4	32	7/8
10455-8-8	10458-8-8	3/4-16	1/2	13	3.04	77	1-3/8	35	7/8
10455-12-12	10458-12-12	1-1/16-14	3/4	19	3.54	90	1-11/16	43	1-1/4

Construction: Steel.

Add "B" for Brass.

Add "C" for Stainless Steel.

For detailed ordering information, please consult price list or contact Parflex® Division.

Parker Hannifin Corporation | Parflex® Division | Ravenna, Ohio | parker.com/pfd

www.comoso.com



E-15

A
Hose

B
Tubing

C
Coiled Air Hose
& Fittings

D
Transportation

E
Fittings
Series 55/58

F
Tooling, Equipment
& Accessories

G
General Technical

A Hose

10555/10558 Male Straight Thread O-ring (BUNA N O-ring included)

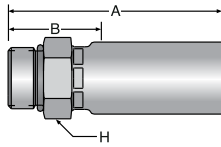

Part Number	Part Number	Thread Size	Hose I.D.		A		Cutoff Allow. B		H Hex
			inch	mm	inch	mm	inch	mm	inch
#	#								
55 Series	58 Series								
10555-4-3	—	7/16-20	3/16	4	1.98	50	1-1/8	29	9/16
10555-4-4	—	7/16-20	1/4	6	2.11	54	1	25	5/8
10555-4-5	—	7/16-20	5/16	8	2.11	54	1	25	5/8
10555-5-4	10558-5-4	1/2-20	1/4	6	2.11	54	1	25	5/8
10555-5-5	—	1/2-20	5/16	8	2.11	54	1	25	5/8
10555-6-3	—	9/16-18	3/16	4	1.89	48	1	25	11/16
10555-6-4	10558-6-4	9/16-18	1/4	6	2.14	54	1	25	11/16
10555-6-6	10558-6-6	9/16-18	3/8	10	2.42	61	1-1/8	29	3/4
10555-8-6	—	3/4-16	3/8	10	2.46	62	1-1/8	29	7/8
10555-8-8	10558-8-8	3/4-16	1/2	13	2.65	67	1-3/16	30	7/8
10555-10-8	10558-10-8	7/8-14	1/2	13	2.77	70	1-5/16	33	1

Construction: Steel.
 Add "B" for Brass.
 Add "C" for Stainless Steel.

B Tubing

C Coiled Air Hose & Fittings

10655/10658 SAE (JIC) 37° Swivel

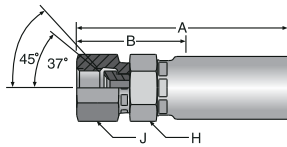

Part Number	Part Number	Thread Size	Hose I.D.		A		Cutoff Allow. B		H Hex	J Hex
			inch	mm	inch	mm	inch	mm	inch	inch
#	#									
55 Series	58 Series									
10655-3-3	—	3/8-24	3/16	5	2.23	57	1-5/16	33	9/16	9/16
10655-4-3	—	7/16-20	3/16	5	2.23	57	1-1/4	32	9/16	9/16
10655-5-3	—	1/2-20	3/16	5	2.24	57	1-1/4	32	9/16	5/8
10655-4-4	10658-4-4	7/16-20	1/4	6	2.36	60	1-3/16	30	5/8	9/16
10655-5-4	10658-5-4	1/2-20	1/4	6	2.43	62	1-1/4	32	5/8	5/8
10655-6-4	10658-6-4	9/16-18	1/4	6	2.45	62	1-5/16	33	5/8	11/16
10655-5-5	10658-5-5	1/2-20	5/16	8	2.46	62	1-1/4	32	5/8	5/8
10655-6-5	10658-6-5	9/16-18	5/16	8	2.48	63	1-1/4	32	5/8	11/16
10655-6-6	10658-6-6	9/16-18	3/8	10	2.70	69	1-5/16	33	11/16	11/16
10655-8-6	10658-8-6	3/4-16	3/8	10	2.89	73	1-1/2	38	11/16	7/8
10655-6-8	10658-6-8	9/16-18	1/2	13	2.96	75	1-3/8	35	7/8	11/16
10655-8-8	10658-8-8	3/4-16	1/2	13	3.08	78	1-1/2	38	7/8	7/8
10655-8-10	10658-8-10	3/4-16	5/8	16	3.30	84	1-5/8	41	1	15/16
10655-10-8	10658-10-8	7/8-14	1/2	13	3.12	79	1-5/8	41	7/8	1-1/16
10655-12-8	10658-12-8	1-1/16-12	1/2	13	3.21	82	1-3/4	44	1	1-1/4
10655-10-10	10658-10-10	7/8-14	5/8	16	3.30	84	1-5/8	41	1	1-1/16
10655-12-10	10658-12-10	1-1/16-12	5/8	16	3.40	86	1-3/4	44	1-1/8	1-5/16
10655-10-12	10658-10-12	7/8-14	3/4	19	3.36	85	1-11/16	43	1-1/8	1-1/16
10655-12-12	10658-12-12	1-1/16-12	3/4	19	3.40	86	1-3/4	44	1-1/8	1-1/4
—	10658-16-12	1-5/16-12	3/4	19	3.55	90	1-13/16	46	1-3/8	1-1/2
10655-16-16	10658-16-16	1-5/16-12	1	25	4.02	102	1-3/4	44	1-3/8	1-1/2

Construction: Steel.
 Add "B" for Brass.
 Add "C" for Stainless Steel.
 NOTE: Sizes -4, -5, -8 and -10 incorporate a dual seat.

D Transportation

E Fittings Series 55/58

F Tooling, Equipment & Accessories

G General Technical



10755/10758 Female Pipe Swivel

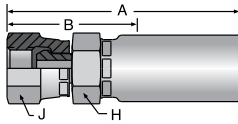

Part Number	Part Number	Thread Size	Hose I.D.		A		Cutoff Allow. B		H Hex	J Hex
			inch	mm	inch	mm	inch	mm	inch	inch
#	#									
55 Series	58 Series									
10755-4-4	10758-4-4	1/4-18	1/4	6	2.43	62	1-1/4	32	5/8	11/16
10755-4-5	—	1/4-18	5/16	8	2.39	61	1-3/16	30	11/16	11/16
10755-6-6	10758-6-6	3/8-18	3/8	10	2.61	66	1-3/16	30	11/16	7/8
10755-8-8	10758-8-8	1/2-14	1/2	13	2.93	74	1-5/16	33	7/8	1
—	10758-12-12	3/4-14	3/4	19	3.48	88	1-3/4	44	1-1/8	1-1/4
10755-16-16	10758-16-16	1-11-1/2	1	25	4.00	102	1-13/16	46	1-3/8	1-1/2

Construction: Steel.

Add "B" for Brass.

Add "C" for Stainless Steel.

10855/10858 Female SAE 45° Swivel

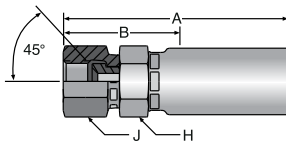

Part Number	Part Number	Thread Size	Hose I.D.		A		Cutoff Allow. B		H Hex	J Hex
			inch	mm	inch	mm	inch	mm	inch	inch
#	#									
55 Series	58 Series									
10855-6-4	—	5/8-18	1/4	6	2.55	65	1-3/8	35	5/8	3/4
10855-6-5	—	5/8-18	5/16	8	2.61	66	1-3/8	35	5/8	3/4
10855-6-6	10858-6-6	5/8-18	3/8	10	2.75	70	1-5/16	33	3/4	3/4
10855-12-12	10858-12-12	1-1/16-14	3/4	19	3.40	86	1-11/16	43	1-1/8	1-1/4

Construction: Steel.

Add "B" for Brass.

Add "C" for Stainless Steel.

For detailed ordering information, please consult price list or contact Parflex® Division.

Parker Hannifin Corporation | Parflex® Division | Ravenna, Ohio | parker.com/pfd

www.comoso.com



E-17

A
Hose

B
Tubing

C
Coiled Air Hose
& Fittings

D
Transportation

E
Fittings
Series 55/58

F
Tooling, Equipment
& Accessories

G
General Technical

A
Hose

11155/11158 Ferrul-Fix (Nut and Sleeve included)

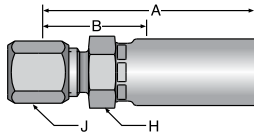

B
Tubing

Part Number	Part Number	Thread Size	Tube O.D.		Hose I.D.		A		Cutoff Allow. B		H Hex	J Hex
			inch	mm	inch	mm	inch	mm	inch	mm	inch	inch
#	#											
55 Series	58 Series		inch	mm	inch	mm	inch	mm	inch	mm	inch	inch
11155-6-4	—	9/16-18	3/8	10	1/4	6	2.34	59	1-1/8	32	11/16	11/16
11155-6-6	—	9/16-18	3/8	10	3/8	10	2.53	64	1-1/8	32	3/4	11/16
11155-8-6	—	3/4-16	1/2	13	3/8	10	2.63	67	1-5/16	33	7/8	7/8

Construction: Steel.

Add "C" for Stainless Steel.

"Ferrul-Fix" affords salvaging of bent tube section of combination tube-hose assemblies and quick, easy repair on the job. See page G-41 for Ferrule-Fix installation instructions.

NOTE: Nut Part Number is 111-size.
Sleeve Part Number is 110-size.

Nut and Sleeve are Manufactured by the Tube Fittings Division. Refer to Catalog 4300 for additional information.

C
Coiled Air Hose & Fittings

D
Transportation

11255/11258 SAE Flareless Swivel

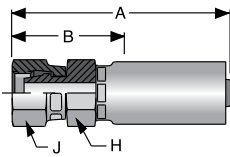

Part Number	Part Number	Thread Size	Hose I.D.		A		Cutoff Allow. B		H Hex	J Hex
			inch	mm	inch	mm	inch	mm	inch	inch
#	#									
55 Series	58 Series		inch	mm	inch	mm	inch	mm	inch	inch
11255-6-4	—	9/16-18	1/4	6	2.62	67	1-1/2	38	11/16	3/4
11255-6-6	—	9/16-18	3/8	10	2.82	72	1-1/2	38	3/4	3/4
11255-8-6	—	3/4-16	3/8	10	2.92	74	1-5/8	41	7/8	15/16

Construction: Steel.

Add "B" for Brass.

Add "C" for Stainless Steel.

E
Fittings Series 55/58

F
Tooling, Equipment & Accessories

G
General Technical

11355/11358 Male Pipe Swivel*

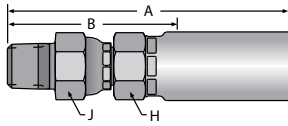

Part Number	Part Number	Thread Size	Hose I.D.		A		Cutoff Allow. B		H Hex	J Hex
			inch	mm	inch	mm	inch	mm	inch	inch
#	#									
55 Series	58 Series		inch	mm	inch	mm	inch	mm	inch	inch
11355-4-3	—	1/4-18	3/16	5	2.72	69	1-3/4	44	5/8	11/16
11355-4-4	11358-4-4	1/4-18	1/4	6	2.84	72	1-3/4	44	5/8	11/16
11355-4-5	—	1/4-18	5/16	8	2.84	72	1-3/4	44	5/8	11/16
11355-6-6	11358-6-6	3/8-18	3/8	10	3.12	79	1-13/16	46	3/4	3/4
11355-8-6	—	1/2-14	3/8	10	3.37	86	2-1/16	52	3/4	15/16
11355-8-8	11358-8-8	1/2-14	1/2	13	3.56	90	2-1/16	52	7/8	15/16
11355-12-12	11358-12-12	3/4-14	3/4	19	3.81	97	2-1/8	54	1-1/8	1-1/8
11355-16-16	11358-16-16	1-11-1/2	1	25	5.06	129	2-13/16	71	1-1/2	1-1/2

Construction: Steel.

Add "C" for Stainless Steel.

NOTE: *For use with petroleum based fluids.

WARNING: Fittings allow minor movement to relieve stress on hose but are not recommended for continued or extensive swiveling. Not recommended for use in CNG applications.

11L55/11L58 Male Pipe Swivel 90° Elbow*

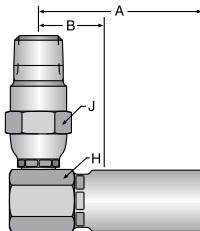

Part Number	Part Number	Thread Size	Hose I.D.		A		Cutoff Allow. B		H Hex	J Hex
			inch	mm	inch	mm	inch	mm	inch	inch
#	#									
55 Series	58 Series		inch	mm	inch	mm	inch	mm	inch	inch
11L55-4-4	—	1/4-18	1/4	6	1.94	49	13/16	21	11/16	11/16

Construction: Steel.

Add "C" for Stainless Steel.

*For use with petroleum based fluids.

NOTE: Use crimp Die Ring 80C-R1L with Parkrimp 1 Machine; crimp Die Ring 82C-R1L with KarryKrimp or MiniKrimp.

WARNING: Fittings allow minor movement under pressure to relieve stress on hose but are not recommended for continued or extensive swiveling. Fittings not recommended for use in CNG applications.

For detailed ordering information, please consult price list or contact Parflex® Division.

Parker Hannifin Corporation | Parflex® Division | Ravenna, Ohio | parker.com/pfd

www.comoso.com



A Hose
 B Tubing
 C Coiled Air Hose & Fittings
 D Transportation
 E Fittings Series 55/58
 F Tooling, Equipment & Accessories
 G General Technical

A
Hose

13755/13758 Female JIC 37° Swivel 45° Elbow

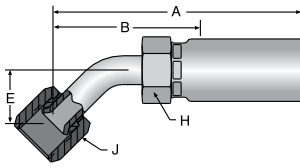

B
Tubing

Part Number	Part Number	Thread Size	Hose I.D.		A		Cutoff Allow. B		E		H Hex	J Hex
			inch	mm	inch	mm	inch	mm	inch	mm	inch	inch
#	#											
55 Series	58 Series		inch	mm	inch	mm	inch	mm	inch	mm	inch	inch
13755-4-3	—	7/16-20	3/16	5	2.49	63	1-1/2	38	0.33	8	9/16	9/16
13755-4-4	13758-4-4	7/16-20	1/4	6	2.49	63	1-1/2	38	0.33	8	5/8	9/16
13755-5-4	—	1/2-20	1/4	6	2.49	63	1-1/2	38	0.36	9	5/8	5/8
13755-6-5	—	9/16-18	5/16	8	2.73	69	1-9/16	40	0.39	10	5/8	11/16
13755-6-6	13758-6-6	9/16-18	3/8	10	2.91	74	1-9/16	40	0.39	10	3/4	11/16
13755-8-6	13758-8-6	3/4-16	3/8	10	3.18	81	1-13/16	46	0.55	14	3/4	7/8
13755-8-8	13758-8-8	3/4-16	1/2	13	3.37	86	1-13/16	46	0.55	14	7/8	7/8
13755-10-8	13758-10-8	7/8-14	1/2	13	3.42	87	1-7/8	48	0.63	16	7/8	1
—	13758-10-10	7/8-14	5/8	16	3.44	87	1-3/4	44	0.64	16	1-1/16	1
13755-12-12	13758-12-12	1-1/16-12	3/4	19	4.05	103	2-3/8	60	0.78	20	1-1/8	1-1/4
13755-16-16	13758-16-16	1-5/16-12	1	25	4.57	116	2-5/16	59	0.89	23	1-3/8	1-1/2

Construction: Steel.

Add "C" for Stainless Steel.

C
Coiled Air Hose & Fittings

D
Transportation

E
Fittings Series 55/58





F
Tooling, Equipment & Accessories

G
General Technical

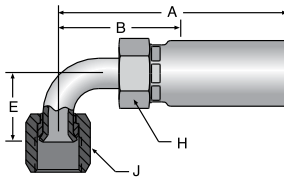

13955/13958 Female JIC 37° Swivel 90° Elbow Short Drop



Part Number #	Part Number #	Thread Size 	Hose I.D. 		A		Cutoff Allow. B		E		H Hex 	J Hex 
			inch	mm	inch	mm	inch	mm	inch	mm	inch	inch
13955-4-3	—	7/16-20	3/16	5	2.49	63	1-3/8	35	0.68	17	9/16	9/16
13955-4-4	13958-4-4	7/16-20	1/4	6	2.49	63	1-3/8	35	0.68	17	5/8	9/16
13955-5-4	—	1/2-20	1/4	6	2.49	63	1-9/16	40	0.77	20	5/8	5/8
13955-6-4	—	9/16-18	1/4	6	2.57	65	1-9/16	36	0.85	22	5/8	11/16
13955-6-5	—	9/16-18	5/16	8	2.73	69	1-1/2	38	0.85	22	5/8	11/16
13955-6-6	13958-6-6	9/16-18	3/8	10	2.91	74	1-1/2	38	0.91	23	11/16	11/16
13955-8-6	13958-8-6	3/4-16	3/8	10	3.18	81	1-9/16	40	1.14	29	3/4	7/8
13955-8-8	13958-8-8	3/4-16	1/2	13	3.37	86	1-5/8	41	1.09	28	7/8	7/8
13955-10-8	13958-10-8	7/8-14	1/2	13	3.42	87	1-3/4	44	1.23	31	7/8	1
—	13958-10-10	7/8-14	5/8	16	3.28	83	1-5/8	41	1.23	31	1-1/16	1
13955-12-12	13958-12-12	1-1/16-12	3/4	19	4.05	103	2-1/4	57	1.81	46	1-1/8	1-1/4
13955-16-16	13958-16-16	1-5/16-12	1	25	4.57	116	2-9/16	65	2.14	54	1-3/8	1-1/2

Construction: Steel.

Add "C" for Stainless Steel.

A
HoseB
TubingC
Coiled Air Hose
& FittingsD
TransportationE
Fittings
Series 55/58F
Tooling, Equipment
& AccessoriesG
General Technical

For detailed ordering information, please consult price list or contact Parflex® Division.

Parker Hannifin Corporation | Parflex® Division | Ravenna, Ohio | parker.com/pfd

www.comoso.com



A
Hose

14155/14158 Female JIC 37° Swivel 90° Elbow Long Drop

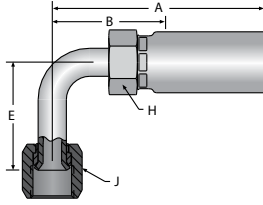

B
Tubing

Part Number	Part Number	Thread Size	Hose I.D.		A		Cutoff Allow. B		E		H Hex	J Hex
#	#											
55 Series	58 Series		inch	mm	inch	mm	inch	mm	inch	mm	inch	inch
14155-4-3	—	7/16-20	3/16	5	2.37	60	1-3/8	35	1.80	46	9/16	9/16
14155-4-4	—	7/16-20	1/4	6	2.57	65	1-7/16	36	1.80	46	5/8	9/16
14155-5-4	—	1/2-20	1/4	6	2.51	64	1-3/8	35	1.80	46	5/8	5/8
14155-6-5	—	9/16-18	5/16	8	2.73	69	1-9/16	40	2.18	55	5/8	11/16
14155-6-6	14158-6-6	9/16-18	3/8	10	2.92	74	1-9/16	40	2.13	54	11/16	11/16
14155-8-6	14158-8-6	3/4-16	3/8	10	3.00	76	1-5/8	41	2.52	64	3/4	7/8
14155-8-8	14158-8-8	3/4-16	1/2	13	3.18	81	1-5/8	41	2.43	62	7/8	7/8
14155-10-8	14158-10-8	7/8-14	1/2	13	3.39	86	1-13/16	46	2.57	65	7/8	1
14155-12-12	14158-12-12	1-1/16-12	3/4	19	3.91	99	2-3/16	56	3.73	95	1-1/8	1-1/4
14155-16-16	14158-16-16	1-5/16-12	1	25	4.62	117	2-3/8	60	4.33	110	1-3/8	1-1/2

Construction: Steel. Add "C" for Stainless Steel.

C
Coiled Air Hose & Fittings

D
Transportation

1L955/1L958 Female JIC 37° Swivel 90° Elbow Special Drop

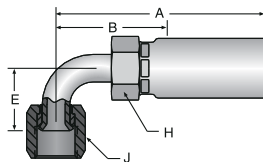

E
Fittings Series 55/58

Part Number	Part Number	Thread Size	Hose I.D.		A		Cutoff Allow. B		E		H Hex	J Hex
#	#											
55 Series	58 Series		inch	mm	inch	mm	inch	mm	inch	mm	inch	inch
1L955-4-3	—	7/16-20	3/16	5	2.31	59	1-3/8	35	0.88	22	9/16	9/16
1L955-4-4	—	7/16-20	1/4	6	2.47	63	1-3/8	35	0.88	22	5/8	9/16
1L955-5-4	—	1/2-20	1/4	6	2.53	64	1-7/16	36	0.88	22	5/8	5/8
1L955-6-5	—	9/16-18	5/16	8	2.69	68	1-1/2	38	1.12	28	5/8	11/16
1L955-6-6	1L958-6-6	9/16-18	3/8	10	2.88	73	1-7/16	36	1.12	28	11/16	11/16
1L955-8-6	1L958-8-6	3/4-16	3/8	10	3.00	76	1-5/8	41	1.61	41	3/4	7/8
1L955-8-8	1L958-8-8	3/4-16	1/2	13	3.19	81	1-5/8	41	1.38	35	7/8	7/8
1L955-10-8	1L958-10-8	7/8-14	1/2	13	3.68	93	2-1/8	54	1.75	44	7/8	1
1L955-12-12	1L958-12-12	1-1/16-12	3/4	19	4.29	109	2-1/2	64	2.06	52	1-1/8	1-1/4
1L955-16-16	1L958-16-16	1-5/16-12	1	25	5.14	131	2-3/4	70	2.50	64	1-3/8	1-1/2

Construction: Steel. Add "C" for Stainless Steel.

F
Tooling, Equipment & Accessories

G
General Technical



For detailed ordering information, please consult price list or contact Parflex® Division.

15555/15858 Hose Splicer

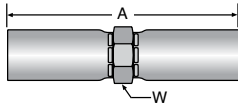

55 Series	58 Series	Hose I.D.		A		W Hex
#	#	⊙				⬡
Part Number	Part Number	inch	mm	inch	mm	inch
15555-4-4	15858-4-4	1/4	6	3.25	83	11/16
15555-5-5	15858-5-5	5/16	8	3.25	83	3/4
15555-6-6	15858-6-6	3/8	10	3.62	92	13/16
15555-8-8	15858-8-8	1/2	13	4.00	102	1
15555-12-12	15858-12-12	3/4	19	4.50	114	1-5/16
15555-16-16	15858-16-16	1	25	5.54	141	1-9/16

Construction: Steel

16755/16758 SAE Male Inverted Swivel 45° Elbow

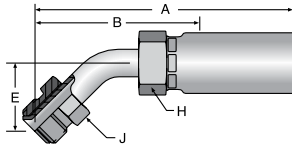

55 Series	Thread Size	Tube O.D.		Hose I.D.		A		Cutoff Allow. B		E		H Hex	J Hex
#	⌘	⊙		⊙								⬡	⬡
Part Number		inch	mm	inch	mm	inch	mm	inch	mm	inch	mm	inch	inch
16755-6-6	5/8-18	3/8	10	3/8	10	3.48	88	2-1/8	54	0.94	24	3/4	5/8

Construction: Steel.

Add "C" for Stainless Steel.

For detailed ordering information, please consult price list or contact Parflex® Division.

Parker Hannifin Corporation | Parflex® Division | Ravenna, Ohio | parker.com/pfd

www.comoso.com



A Hose
 B Tubing
 C Coiled Air Hose & Fittings
 D Transportation
 E Fittings Series 55/58
 F Tooling, Equipment & Accessories
 G General Technical

A
Hose

16955/16958 SAE Male Inverted Swivel 90° Elbow

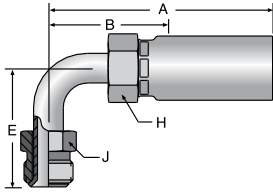

B
Tubing

Part Number	Part Number	Thread Size	Hose I.D.		A		Cutoff Allow. B		E		H Hex	J Hex
#	#											
55 Series	58 Series		inch	mm	inch	mm	inch	mm	inch	mm	inch	inch
16955-6-6	—	5/8-18	3/8	10	3.48	88	1-3/4	27	1.69	43	3/4	5/8

Construction: Steel.

Add "C" for Stainless Steel.

C
Coiled Air Hose & Fittings

D
Transportation

1JS55/1JS58 Female Seal-Lok™ Straight ISO 12151-1-SWSB

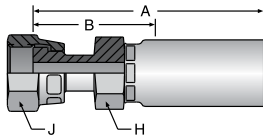

Part Number	Part Number	Thread Size	Hose I.D.		A		Cutoff Allow. B		H Hex	J Hex
#	#									
55 Series	58 Series		inch	mm	inch	mm	inch	mm	inch	inch
1JS55-4-3	—	9/16-18	3/16	5	2.23	57	1-1/4	32	9/16	11/16
1JS55-4-4	—	9/16-18	1/4	6	2.42	61	1-1/4	32	5/8	11/16
1JS55-6-4	—	11/16-16	1/4	6	2.48	63	1-1/4	32	11/16	13/16
1JS55-6-5	—	11/16-16	5/16	8	2.54	65	1-5/16	33	11/16	13/16
1JS55-6-6	1JS58-6-6	11/16-16	3/8	10	2.73	69	1-5/16	33	11/16	13/16
1JS55-8-6	—	13/16-16	3/8	10	3.00	76	1-5/8	41	7/8	15/16
1JS55-8-8	1JS58-8-8	13/16-16	1/2	13	3.20	81	1-5/8	41	7/8	15/16
1JS55-10-10	1JS58-10-10	1-14	5/8	16	3.53	90	1-7/8	48	1-1/8	1-1/8
1JS55-12-12	1JS58-12-12	1-3/16-12	3/4	19	3.75	95	2	51	1-1/4	1-3/8

Construction: Steel.

Add "C" for Stainless Steel.

E
Fittings Series 55/58

F
Tooling, Equipment & Accessories

G
General Technical



1JC55/1JC58 Female Seal-Lok™ Straight - Swivel - Short

ISO 12151-1-SWSA

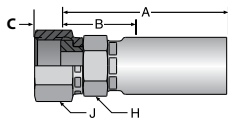

Part Number	Part Number	Thread Size	Hose I.D.		A		Cutoff Allow. B		C		H Hex	J Hex
			inch	mm	inch	mm	inch	mm	inch	mm	inch (mm)	inch (mm)
#	#											
55 Series	58 Series		inch	mm	inch	mm	inch	mm	inch	mm	inch (mm)	inch (mm)
1JC55-4-3	—	9/16-18	3/16	5	1.88	48	15/16	24	.32	8	9/16	11/16
1JC55-4-4	1JC58-4-4	9/16-18	1/4	6	2.16	55	1-1/16	25	.32	8	5/8	11/16
1JC55-6-4	1JC58-6-4	11/16-16	1/4	6	2.22	56	1-1/16	27	.32	8	11/16	13/16
1JC55-4-5	1JC58-4-5	9/16-18	5/16	8	2.22	56	1	27	.32	8	5/8	11/16
1JC55-6-5	1JC58-6-5	11/16-16	5/16	8	2.28	58	1-1/16	27	.32	8	11/16	13/16
1JC55-6-6	1JC58-6-6	11/16-16	3/8	10	2.47	63	1-1/16	27	.32	8	11/16	13/16
1JC55-6-6-SM	1JC58-6-6-SM	11/16-16	3/8	10	2.47	63	1-1/16	27	.32	8	(19)	(22)
1JC55-8-6	1JC58-8-6	13/16-16	3/8	10	2.56	65	1-3/16	30	.43	11	7/8	15/16
1JC55-8-6-SM	1JC58-8-6-SM	13/16-16	3/8	10	2.56	65	1-3/16	30	.43	11	(24)	(24)
1JC55-8-8	1JC58-8-8	13/16-16	1/2	13	2.75	70	1-3/16	30	.43	11	7/8	15/16
1JC55-10-8	1JC58-10-8	1-14	1/2	13	2.95	75	1-3/8	35	.53	13	1-1/8	1-1/8
—	1JC58-10-10	1-14	5/8	16	3.05	77	1-3/8	35	.53	13	1-1/8	1-1/8
1JC55-10-12	1JC58-10-12	1-14	3/4	19	3.15	80	1-3/8	35	.53	13	1-1/8	1-1/8
1JC55-12-8	—	1-3/16-12	1/2	13	3.00	76	1-7/16	36	.57	14	1-1/4	1-3/8
1JC55-12-10	1JC58-12-10	1-3/16-12	5/8	16	3.10	79	1-7/16	36	.57	14	1-1/4	1-3/8
1JC55-12-12	1JC58-12-12	1-3/16-12	3/4	19	3.20	81	1-7/16	36	.57	14	1-1/4	1-3/8
1JC55-16-16	1JC58-16-16	1-7/16-12	1	25	3.74	95	1-1/2	38	.58	15	1-1/2	1-5/8
—	1JC58-20-16	1-11/16-12	1	25	3.78	96	1-9/16	40	.59	15	1-5/8	1-3/8

Construction: Steel.

Add "C" for Stainless Steel.

1J055/1J058 Male Seal-Lok™ Rigid Straight (with Buna N O-ring)

ISO 12151-1-S

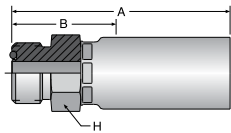

Part Number	Part Number	Thread Size	Hose I.D.		A		Cutoff Allow. B		H Hex
			inch	mm	inch	mm	inch	mm	inch (mm)
#	#								
55 Series	58 Series		inch	mm	inch	mm	inch	mm	inch (mm)
1J055-4-4	—	9/16-18	1/4	6	2.20	56	1-1/16	27	5/8
1J055-4-4-SM	—	9/16-18	1/4	6	2.20	56	1-1/16	27	(17)
1J055-6-6	1J058-6-6	11/16-16	3/8	10	2.53	63	1-1/8	29	3/4
1J055-6-6-SM	1J058-6-6-SM	11/16-16	3/8	10	2.47	63	1-1/8	29	(19)
1J055-8-6	—	13/16-16	3/8	10	2.62	67	1-1/4	32	7/8
1J055-8-6-SM	—	13/16-16	3/8	10	2.62	67	1-1/4	32	(24)
1J055-8-8	1J058-8-8	13/16-16	1/2	13	2.75	70	1-1/4	32	15/16
1J055-8-8-SM	1J058-8-8-SM	13/16-16	1/2	13	2.75	70	1-1/4	32	(24)

Construction: Steel.

Add "C" for Stainless Steel.

For detailed ordering information, please consult price list or contact Parflex® Division.

Parker Hannifin Corporation | Parflex® Division | Ravenna, Ohio | parker.com/pfdwww.comoso.com

E-25

A Hose

B Tubing

C Coiled Air Hose & Fittings

D Transportation

E Fittings Series 55/58

F Tooling, Equipment & Accessories

G General Technical

A
Hose

1J155/1J158 Female Seal-Lok™ Swivel 90° Elbow Long Drop ISO 12151-1-SWEL90

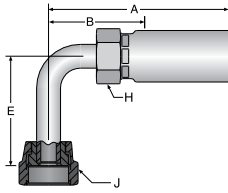
B
Tubing

Part Number	Part Number	Thread Size	Hose I.D.		A		Cutoff Allow. B		E		H Hex	J Hex
#	#											
55 Series	58 Series		inch	mm	inch	mm	inch	mm	inch	mm	inch	inch
1J155-4-3	—	9/16-18	3/16	5	2.30	58	1-5/16	33	1.80	46	9/16	11/16
1J155-4-4	—	9/16-18	1/4	6	2.45	62	1-5/16	46	1.80	46	9/16	11/16
1J155-6-6	1J158-6-6	11/16-16	3/8	10	2.94	75	1-3/4	44	2.13	54	11/16	13/16
1J155-8-6	—	13/16-16	3/8	10	2.94	75	1-5/8	41	2.52	64	3/4	15/16
1J155-8-8	1J158-8-8	13/16-16	1/2	13	3.21	82	1-11/16	43	2.52	64	7/8	15/16
—	1J158-10-10	1-14	5/8	16	3.35	85	1-11/16	43	2.76	70	1-1/16	1-1/8
1J155-12-12	1J158-12-12	1-3/16-12	3/4	19	3.86	98	2-1/8	54	3.78	96	1-1/8	1-3/8
1J155-16-16	1J158-16-16	1-7/16-12	1	25	4.42	112	2-3/8	60	4.50	114	1-3/8	1-5/8

Construction: Steel.

Add "C" for Stainless Steel.

C
Coiled Air Hose
& FittingsD
Transportation

1J755/1J758 Female Seal-Lok™ Swivel 45° Elbow ISO 12151-1-SWE45

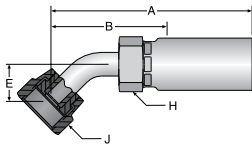
E
Fittings Series 55/58

Part Number	Part Number	Thread Size	Hose I.D.		A		Cutoff Allow. B		E		H Hex	J Hex
#	#											
55 Series	58 Series		inch	mm	inch	mm	inch	mm	inch	mm	inch	inch
1J755-4-4	1J758-4-4	9/16-18	1/4	6	2.66	68	1-1/2	38	0.41	10	5/8	11/16
1J755-6-4	—	11/16-16	1/4	6	2.74	70	1-5/8	41	0.43	11	5/8	13/16
1J755-6-6	1J758-6-6	11/16-16	3/8	10	2.98	76	1-5/8	43	0.43	11	3/4	13/16
1J755-8-6	—	13/16-16	3/8	10	3.23	82	1-15/16	49	0.59	15	3/4	15/16
1J755-8-8	1J758-8-8	13/16-16	1/2	13	3.43	87	1-15/16	49	0.59	15	7/8	15/16
—	1J758-10-10	1-14	5/8	16	3.56	90	1-7/8	48	0.65	17	1-1/16	1
1J755-12-12	1J758-12-12	1-3/16-12	3/4	19	3.67	93	2	51	0.81	21	1-1/8	1-3/8
1J755-16-16	1J758-16-16	1-7/16-12	1	25	5.10	130	2-7/8	73	0.94	24	1-3/8	1-5/8

Construction: Steel.

Add "C" for Stainless Steel.

F
Tooling, Equipment
& AccessoriesG
General Technical

1J955/1J958 Female Seal-Lok™ Swivel 90° Elbow Short Drop ISO 12151-1-SWES90

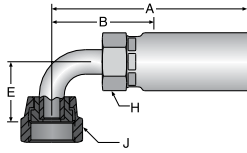

Part Number	Part Number	Thread Size	Hose I.D.		A		Cutoff Allow. B		E		H Hex	J Hex
#	#											
55 Series	58 Series		inch	mm	inch	mm	inch	mm	inch	mm	inch	inch
1J955-4-4	—	9/16-18	1/4	6	2.49	63	1-3/8	35	0.82	21	5/8	11/16
1J955-6-4	—	11/16-16	1/4	6	2.59	66	1-7/16	36	0.90	23	5/8	13/16
1J955-6-5	—	11/16-16	5/16	8	2.66	68	1-1/2	38	0.90	23	5/8	13/16
1J955-6-6	1J958-6-6	11/16-16	3/8	10	2.85	72	1-1/2	38	0.91	23	3/4	13/16
1J955-8-6	—	13/16-16	1/2	13	3.15	80	1-5/8	41	1.14	29	3/4	15/16
—	1J958-8-8	13/16-16	1/2	13	3.15	80	1-5/8	41	1.14	29	7/8	15/16
—	1J958-10-10	1-14	5/8	16	3.26	83	1-5/8	41	1.27	32	1-1/16	1
1J955-12-12	1J958-12-12	1-3/16-12	3/4	19	3.82	89	2-1/8	54	1.85	47	1-3/8	1-3/8
1J955-16-16	1J958-16-16	1-7/16-12	1	25	5.03	128	2-15/16	75	2.21	56	1-3/8	1-5/8

Construction: Steel.

Add "C" for Stainless Steel.

1TU55/1TU58 Universal Inch Tube Stub End

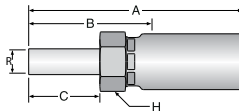

Part Number	Part Number	Diameter R	Hose I.D.		A		Cutoff Allow. B		C		H Hex
#	#										
55 Series	58 Series	inch	inch	mm	inch	mm	inch	mm	inch	mm	inch
1TU55-4-4	1TU58-4-4	1/4	1/4	6	2.60	66	1-1/2	38	0.72	18	5/8
1TU55-6-6	1TU58-6-6	3/8	3/8	10	2.91	74	1-1/2	38	0.78	20	3/4
1TU55-8-8	1TU58-8-8	1/2	1/2	13	3.35	85	1-13/16	46	1.03	26	7/8
1TU55-12-12	1TU58-12-12	3/4	3/4	19	3.66	93	1-15/16	49	1.03	26	1-1/8
1TU55-16-16	1TU58-16-16	1	1	25	4.41	112	2-3/16	56	1.29	33	1-3/8

Construction: Steel.

Add "C" for Stainless Steel.

NOTE: Use with A-Lok & CPI nuts, sleeves and adapters. These components are manufactured by Parker's Instrumentation Connectors Division. Refer to catalogs 4230 & 4233 for additional information.

For detailed ordering information, please consult price list or contact Parflex® Division.

Parker Hannifin Corporation | Parflex® Division | Ravenna, Ohio | parker.com/pfd

www.comoso.com



E-27

A
Hose

B
Tubing

C
Coiled Air Hose
& Fittings

D
Transportation

E
Fittings 55/58
Series

F
Tooling, Equipment
& Accessories

G
General Technical

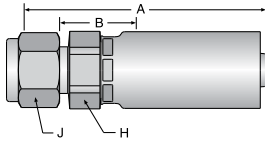
A
Hose**1AL55/1AL58 A-LOK® Compression (With Nut and Ferrule)**

Part Number	Part Number	Thread Size	Tube O.D.	Hose I.D.		A		Cutoff Allow. B		H Hex	J Hex
#	#										
55 Series	58 Series		inch	inch	mm	inch	mm	inch	mm	inch	inch
1AL55-4-4	1AL58-4-4	7/16-20	1/4	1/4	6	2.16	55	11/16	17	5/8	9/16
1AL55-6-6	1AL58-6-6	9/16-20	3/8	3/8	10	2.56	65	13/16	21	3/4	11/16
1AL55-8-8	1AL58-8-8	3/4-20	1/2	1/2	13	2.81	71	3/4	19	15/16	7/8

Construction: 316 Stainless nipple and shell.

NOTE: Nut part No. is **XNUX** or **XNUX-316** for stainless steel.
 Front ferrule part No. is **XFFX** or **XFFX-316** for stainless steel.
 Back ferrule part No. is **XBFX** or **XBFX-316** for stainless steel.
 X denotes dash size.

Nuts and Ferrules are Manufactured by the Instrumentation Products Division. Refer to Catalog 4300 for additional information.

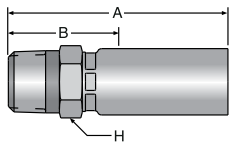
B
TubingC
Coiled Air Hose
& FittingsD
TransportationE
Fittings Series 55/58**1UT55/1UT58 Male Rigid (JIS)/BSPT**

Part Number	Part Number	Thread Size	Hose I.D.		A		Cutoff Allow. B		H Hex
#	#								
55 Series	58 Series		inch	mm	inch	mm	inch	mm	mm
1UT55-4-3	—	PT 1/4-19	3/16	5	2.20	56	1-1/4	32	19
1UT55-4-4	—	PT 1/4-19	1/4	6	2.36	60	1-1/4	32	19

Construction: Steel.

Add "C" for Stainless Steel.

F
Tooling, Equipment
& AccessoriesG
General Technical

1FU55/1FU58 (JIS)/BSP 30° Flare Female Swivel

ISO 228-1

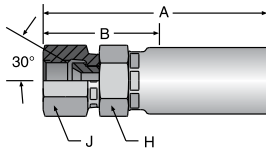

Part Number	Part Number	Thread Size	Hose I.D.		A		Cutoff Allow. B		H Hex	J Hex
			inch	mm	inch	mm	inch	mm	mm	mm
#	#									
55 Series	58 Series		inch	mm	inch	mm	inch	mm	mm	mm
1FU55-4-4	1FU58-4-4	PF 1/4-19	1/4	6	2.48	63	1-9/16	40	19	19
1FU55-6-6	1FU58-6-6	PF 3/8-19	3/8	10	2.88	73	1-11/16	43	22	22
1FU55-8-8	1FU58-8-8	PF 1/2-14	1/2	13	3.27	83	1-7/8	48	27	27
1FU55-12-12	1FU58-12-12	PF 3/4-14	3/4	19	3.58	91	1-3/16	31	36	36
1FU55-16-16	1FU58-16-16	PF 1-11	1	25	4.22	107	1-3/8	35	41	41

Construction: Steel.

Add "C" for Stainless Steel.

1GU55/1GU58 (JIS)/BSP 60° Cone Female Swivel

ISO 228-1

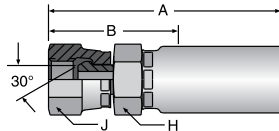

Part Number	Part Number	Thread Size	Hose I.D.		A		Cutoff Allow. B		H Hex	J Hex
			inch	mm	inch	mm	inch	mm	mm	mm
#	#									
55 Series	58 Series		inch	mm	inch	mm	inch	mm	mm	mm
1GU55-4-4	—	PF 1/4-19	1/4	6	2.44	62	1-1/4	32	19	19
1GU55-6-6	1GU58-6-6	PF 3/8-19	3/8	10	2.76	70	1-3/8	35	22	22
1GU55-8-8	—	PF 1/2-14	1/2	13	3.24	82	1-11/16	43	27	27
1GU55-12-12	—	PF 3/4-14	3/4	19	3.46	88	1-13/16	46	27	36

Construction: Steel.

Add "C" for Stainless Steel.

1MU55/1MU58 (JIS) Metric 30° Flare Female Swivel

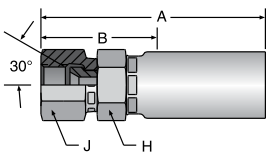

Part Number	Part Number	Thread Size	Hose I.D.		A		Cutoff Allow. B		H Hex	J Hex
			inch	mm	inch	mm	inch	mm	mm	mm
#	#									
55 Series	58 Series		inch	mm	inch	mm	inch	mm	mm	mm
1MU55-4-4	—	M14 x 1,5	1/4	6	2.41	61	1-5/16	33	19	19
1MU55-4-6	—	M14 x 1,5	3/8	10	2.75	70	1-3/8	35	19	19
1MU55-6-6	—	M18 x 1,5	3/8	10	2.86	73	1-1/2	38	22	24
1MU55-8-8	—	M22 x 1,5	1/2	13	3.19	81	1.63	41	27	27

Construction: Steel.

Add "C" for Stainless Steel.

For detailed ordering information, please consult price list or contact Parflex® Division.

Parker Hannifin Corporation | Parflex® Division | Ravenna, Ohio | parker.com/pfdwww.comoso.com

E-29

Hose
ATubing
BCoiled Air Hose
& Fittings
CTransportation
DFittings 55/58
Series
ETooling, Equipment
& Accessories
FGeneral Technical
G

A
Hose

1G155/1G158 (JIS)/BSP 60° Cone Female Swivel 45° Elbow ISO 228-1

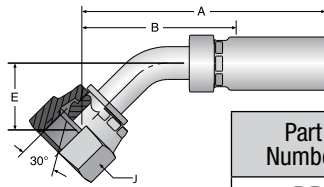

Part Number	Part Number	Thread Size	Hose I.D.		A		Cutoff Allow. B		E		J Hex
			inch	mm	inch	mm	inch	mm	inch	mm	mm
#	#										
55 Series	58 Series		inch	mm	inch	mm	inch	mm	inch	mm	mm
1G155-4-4	—	PF 1/4-19	1/4	6	3.30	84	2-3/16	56	0.79	20	19
1G155-6-6	—	PF 3/8-19	3/8	10	3.48	88	2-1/8	54	0.82	21	22
1G155-8-8	—	PF 1/2-14	1/2	13	4.27	108	2-11/16	68	1.16	30	27

Construction: Steel.

Add "C" for Stainless Steel.

B
Tubing

C
Coiled Air Hose
& Fittings

D
Transportation

1G255/1G258 (JIS)/BSP 60° Cone Female Swivel 90° Elbow ISO 228-1

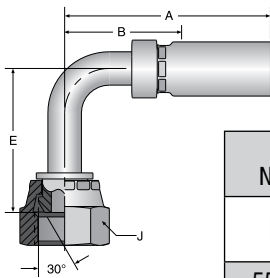

Part Number	Part Number	Thread Size	Hose I.D.		A		Cutoff Allow. B		E		J Hex
			inch	mm	inch	mm	inch	mm	inch	mm	mm
#	#										
55 Series	58 Series		inch	mm	inch	mm	inch	mm	inch	mm	mm
1G255-4-4	—	PF 1/4-19	1/4	6	2.57	65	1-7/16	37	0.94	24	19
1G255-6-6	—	PF 3/8-19	3/8	10	3.06	78	1-9/16	40	1.50	38	22
1G255-8-8	—	PF 1/2-14	1/2	13	3.26	83	1-11/16	43	1.81	46	27

Construction: Steel.

Add "C" for Stainless Steel.

E
Fittings Series 55/58

F
Tooling, Equipment
& Accessories

G
General Technical

1C655/1C658 Female Metric Swivel DIN 20078 Heavy Series

(Without O-ring) ISO 8434-1

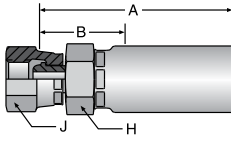

Part Number	Part Number	Thread Size	Hose I.D.		A		Cutoff Allow. B		H Hex	J Hex
			inch	mm	inch	mm	inch	mm	mm	mm
#	#									
55 Series	58 Series									
1C655-8-3	—	M16 x 1,5	3/16	5	2.25	57	1-3/8	35	19	19
1C655-10-4	1C658-10-4	M18 x 1,5	1/4	6	2.50	64	1-3/8	35	19	22
1C655-12-5	—	M20 x 1,5	5/16	8	2.57	65	1-7/16	37	24	24
1C655-14-6	—	M22 x 1,5	3/8	10	3.02	77	1-5/8	41	27	27
1C655-16-8	1C658-16-8	M24 x 1,5	1/2	13	3.19	81	1-5/8	41	27	30
1C655-20-12	—	M30 x 2	3/4	19	3.46	88	1-11/16	43	36	36
—	1C658-25-12	M36x2	3/4	19	3.64	92	1-7/8	48	41	46

Construction: Steel.

Add "C" for Stainless Steel.

1C955/1C958 Female Metric Swivel DIN 20078 Heavy Series

(With O-ring) ISO 12151-2-SWS

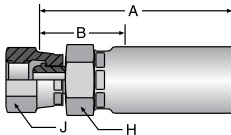

Part Number	Part Number	Thread Size	Hose I.D.		A		Cutoff Allow. B		H Hex	J Hex
			inch	mm	inch	mm	inch	mm	mm	mm
#	#									
55 Series	58 Series									
1C955-8-3	—	M16 x 1,5	3/16	5	2.15	55	1-1/4	32	19	19
1C955-10-4	1C958-10-4	M18 x 1,5	1/4	6	2.46	63	1-5/16	33	19	22
1C955-12-5	1C958-12-5	M20 x 1,5	5/16	8	2.54	65	1-7/16	37	24	24
1C955-14-6	1C958-14-6	M22 x 1,5	3/8	10	2.95	75	1-9/16	40	27	27
1C955-16-8	1C958-16-8	M24 x 1,5	1/2	13	3.18	81	1-9/16	40	24	30
1C955-20-12	1C958-20-12	M30 x 2	3/4	19	3.33	85	1-9/16	40	36	36
1C955-25-12	1C958-25-12	M36 x 2	3/4	19	3.55	90	1-13/16	46	41	46

Construction: Steel.

Add "C" for Stainless Steel.

For detailed ordering information, please consult price list or contact Parflex® Division.

Parker Hannifin Corporation | Parflex® Division | Ravenna, Ohio | parker.com/pfd

www.comoso.com



E-31

A Hose
 B Tubing
 C Coiled Air Hose & Fittings
 D Transportation
 E Fittings Series 55/58
 F Tooling, Equipment & Accessories
 G General Technical

A
Hose

1D055/1D058 Male Stud DIN 20078 Light Series

ISO 8434-1

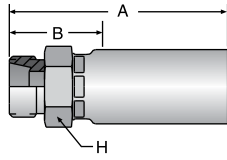

Part Number	Part Number	Thread Size	Hose I.D.		A		Cutoff Allow. B		H Hex
			inch	mm	inch	mm	inch	mm	
#	#								
55 Series	58 Series		inch	mm	inch	mm	inch	mm	mm
1D055-6-3	—	M12 x 1,5	3/16	5	1.93	49	1	25	15
1D055-8-4	—	M14 x 1,5	1/4	6	2.17	55	1	25	19
1D055-10-5	—	M16 x 1,5	5/16	8	2.28	58	1	25	19
1D055-12-5	—	M18 x 1,5	5/16	8	2.32	59	1-1/16	27	22
1D055-10-6	1D058-10-6	M16 x 1,5	3/8	10	2.52	64	1	26	22
1D055-12-6	1D058-12-6	M18 x 1,5	3/8	10	2.52	64	1-1/16	27	22
1D055-15-8	1D058-15-8	M22 x 1,5	1/2	13	2.80	71	1-3/16	30	27
1D055-18-12	—	M26 x 1,5	3/4	19	3.03	77	1-3/16	30	32
—	1D058-22-12	M30x2	3/4	19	3.11	79	1-1/4	32	36
—	1D058-28-16	36x2	1	25	3.54	90	1-1/4	32	41

Construction: Steel.

Add "C" for Stainless Steel.

B
TubingC
Coiled Air Hose
& FittingsD
TransportationE
Fittings Series 55/58F
Tooling, Equipment
& AccessoriesG
General Technical

1D255/1D258 Male Stud DIN 20078 Heavy Series

ISO 8434-1

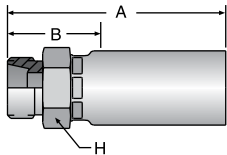

Part Number	Part Number	Thread Size	Hose I.D.		A		Cutoff Allow. B		H Hex
			inch	mm	inch	mm	inch	mm	
#	#								
55 Series	58 Series		inch	mm	inch	mm	inch	mm	mm
1D255-10-4	1D258-10-4	M18 x 1,5	1/4	6	2.28	58	1-1/8	29	22
1D255-12-5	—	M20 x 1,5	5/16	8	2.44	62	1-3/16	30	24
1D255-12-6	—	M20 x 1,5	3/8	10	2.64	67	1-3/16	30	24
1D255-14-6	1D258-14-6	M22 x 1,5	3/8	10	2.72	69	1-1/4	32	27
1D255-16-8	1D258-16-8	M24 x 1,5	1/2	13	2.87	73	1-1/4	32	27
1D255-20-12	1D258-20-12	M30 x 2	3/4	19	3.19	81	1-5/16	33	36
—	1D258-25-12	M36x2	3/4	19	3.27	83	1-3/8	35	41
—	1D258-30-16	M42x2	1	25	3.90	99	1-3/8	35	46

Construction: Steel.

Add "C" for Stainless Steel.

1D955/1D958 Male BSPP - Rigid

ISO 228-1

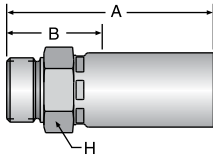

Part Number	Part Number	Thread Size	Hose I.D.		A		Cutoff Allow. B		H Hex
			inch	mm	inch	mm	inch	mm	mm
#	#								
55 Series	58 Series		inch	mm	inch	mm	inch	mm	mm
1D955-4-4	—	PF 1/4-19	1/4	6	2.30	59	1-1/8	29	19
1D955-6-6	—	PF 3/8-19	3/8	10	2.52	64	1-1/16	27	22
1D955-8-8	—	PF 1/2-14	1/2	12	2.87	73	1-1/4	32	27
—	1D958-16-16	PF 1-11	1	25	3.74	95	1-3/8	35	41

Construction: Steel.

Add "C" for Stainless Steel.

NOTE: When used in a port, a bonded seal must be used. Purchase from Parker's Tube Fittings Division. Ref. P/N D9DT-SIZE.

11D55/11D58 Metric Standpipe Light Series

ISO 8434-1

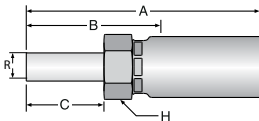

Part Number	Part Number	Diameter R		Hose I.D.		A		Cutoff Allow. B		C		H Hex
		mm	inch	inch	mm	inch	mm	inch	mm	inch	mm	mm
#	#											
55 Series	58 Series	mm	inch	inch	mm	inch	mm	inch	mm	inch	mm	mm
11D55-6-3	—	6	.236	3/16	5	2.37	60	1-7/16	36	0.87	22	14
11D55-8-4	—	8	.315	1/4	6	2.64	67	1-1/2	38	0.87	22	17
11D55-10-5	—	10	.394	5/16	8	2.76	70	1-7/16	36	0.91	23	17
11D55-10-6	11D58-10-6	10	.394	3/8	10	2.95	75	1-9/16	40	0.91	23	19
11D55-12-6	—	12	.472	3/8	10	3.15	80	1-3/4	45	1.02	26	19
11D55-15-8	11D58-15-8	15	.591	1/2	13	3.23	82	1-11/16	43	0.98	25	22
11D55-18-12	11D58-18-12	18	.709	3/4	19	3.66	93	1-7/8	48	0.98	25	30
11D55-22-12	11D58-22-12	22	.866	3/4	19	3.66	93	1-7/8	48	1.10	28	30
11D55-28-16	11D58-28-16	28	1.10	1	25	4.21	107	1-5/16	33	1.18	30	36

Construction: Steel.

Add "C" for Stainless Steel.

NOTE: Mates with Parker's Tube Fittings Division EO "L" Series Adapters.

For detailed ordering information, please consult price list or contact Parflex® Division.

Parker Hannifin Corporation | Parflex® Division | Ravenna, Ohio | parker.com/pfd

www.comoso.com



E-33

A
Hose

B
Tubing

C
Coiled Air Hose
& Fittings

D
Transportation

E
Fittings
Series 55/58

F
Tooling, Equipment
& Accessories

G
General Technical

A
Hose

13D55/13D58 Metric Standpipe Heavy Series

ISO 8434-1

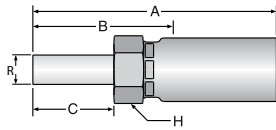

Part Number	Part Number	Diameter R		Hose I.D.		A		Cutoff Allow. B		C		H Hex
#	#	⌀		⊙								⬡
55 Series	58 Series	mm	inch	inch	mm	inch	mm	inch	mm	inch	mm	mm
13D55-8-3	—	8	.315	3/16	5	2.45	62	1-1/2	38	0.94	24	14
13D55-10-4	—	10	.394	1/4	6	2.80	71	1-11/16	43	0.94	24	17
13D55-12-5	—	12	.472	5/16	8	2.86	73	1-11/16	43	1.02	26	17
13D55-12-6	—	12	.472	3/8	10	3.05	77	1-11/16	43	1.02	26	19
13D55-14-6	—	14	.551	3/8	10	3.17	81	1-13/16	46	1.02	26	19
13D55-16-8	—	16	.630	1/2	13	3.44	87	1-7/8	48	1.18	30	22

Construction: Steel.

Add "C" for Stainless Steel.

NOTE: Mates with Parker's Tube Fittings Division E0 "S" Series Adapters.

B
TubingC
Coiled Air Hose
& FittingsD
Transportation

19255/19258 Female BSP Parallel Pipe Swivel Straight (60° Cone)

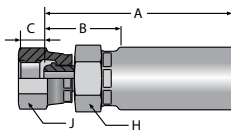

Part Number	Part Number	Thread Size	Hose I.D.		A		Cutoff Allow. B		C		H Hex	J Hex
#	#	⌀	⊙								⬡	⬡
55 Series	58 Series		inch	mm	inch	mm	inch	mm	inch	mm	mm	mm
19255-4-3	—	PF 1/4-19	3/16	5	2.01	51	1-1/16	27	0.22	6	17	19
19255-4-4	19258-4-4	PF 1/4-19	1/4	6	2.20	56	1-1/16	27	0.22	6	17	19
19255-6-5	—	PF 3/8-19	5/16	8	2.25	57	1-1/16	27	0.26	7	19	22
19255-6-6	19258-6-6	PF 3/8-19	3/8	10	2.44	62	1-1/16	27	0.26	7	19	22
19255-8-8	19258-8-8	PF 1/2-14	1/2	13	2.78	71	1-3/16	31	0.28	7	24	27
19255-12-12	19258-12-12	PF 3/4-14	3/4	19	3.06	78	1-5/16	33	0.36	9	32	32
19255-16-16	19258-16-16	PF 1-11	1	25	3.72	94	1-1/2	37	0.44	11	36	41

Construction: Steel.

Add "C" for Stainless Steel.

NOTE: When measuring overall length to the end of the nut, B+C dimensions must be used to calculate cut-off allowance.

E
Fittings Series 55/58F
Tooling, Equipment
& AccessoriesG
General Technical

1B155/1B158 Female BSP Parallel Pipe Swivel 45° Elbow (60° Cone) ISO 228-1

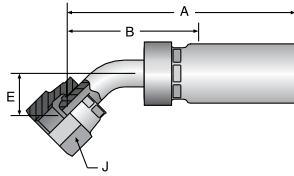

Part Number	Part Number	Thread Size	Tube O.D.		Hose I.D.		A		Cutoff Allow. B		E		J Hex
#	#												
55 Series	58 Series		inch	mm	inch	mm	inch	mm	inch	mm	inch	mm	
1B155-4-4	—	PF 1/4-19	1/4	6	1/4	6	3.03	77	1-7/8	48	.61	16	19
1B155-6-5	—	PF 3/8-19	3/8	10	5/16	8	3.60	91	2-1/4	57	.67	17	22
1B155-6-6	—	PF 3/8-19	3/8	10	3/8	10	3.60	91	2-1/4	57	.67	17	22
1B155-8-8	—	PF 1/2-14	1/2	13	1/2	13	4.28	109	2-11/16	68	.79	20	27

Construction: Steel.

Add "C" for Stainless Steel.

1B255/1B258 Female BSP Parallel Pipe Swivel 90° Elbow (60° Cone) ISO 228-1

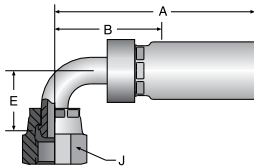

Part Number	Part Number	Thread Size	Tube O.D.		Hose I.D.		A		Cutoff Allow. B		E		J Hex
#	#												
55 Series	58 Series		inch	mm	inch	mm	inch	mm	inch	mm	inch	mm	
1B255-4-4	—	PF 1/4-19	1/4	6	1/4	6	2.39	61	1-1/4	32	1.14	29	19
1B255-6-5	—	PF 3/8-19	3/8	10	5/16	8	2.72	69	1-3/8	35	1.34	34	22
1B255-6-6	—	PF 3/8-19	3/8	10	3/8	10	2.81	71	1-1/2	38	1.37	35	22
1B255-8-8	—	PF 1/2-14	1/2	13	1/2	13	3.27	83	1-9/16	40	1.57	40	27
1B255-10-8	—	PF 5/8-14	1/2	13	1/2	13	3.28	83	1-11/16	43	1.89	48	30
1B255-12-12	—	PF 3/4-14	3/4	19	3/4	19	4.20	107	2-7/16	62	2.54	65	36

Construction: Steel.

Add "C" for Stainless Steel.







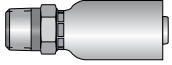
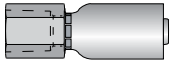
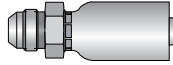
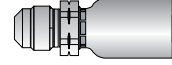
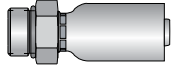
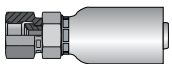
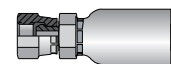
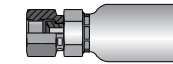
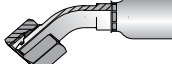
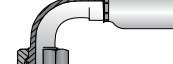
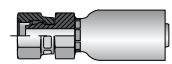
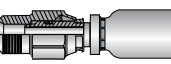
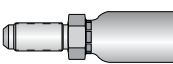
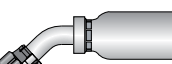
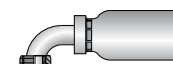
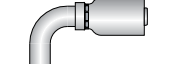

For detailed ordering information, please consult price list or contact Parflex® Division.

Parker Hannifin Corporation | Parflex® Division | Ravenna, Ohio | parker.com/pfd

www.comoso.com

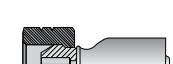
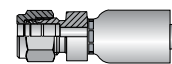

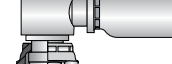
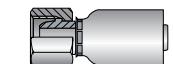
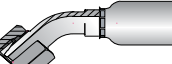
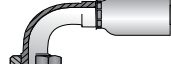
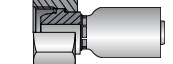
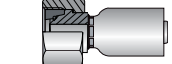

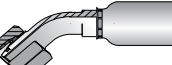
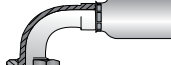
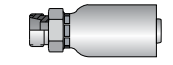
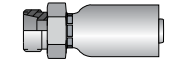
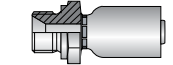

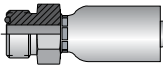
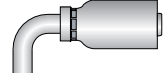
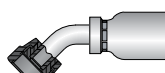
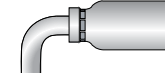
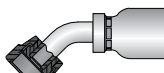
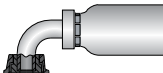
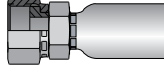
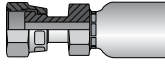
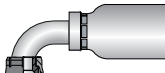
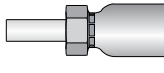
56 Series Visual Index

A Hose	B Tubing	C Coiled Air Hose & Fittings	D Transportation	E Fittings Series 56	F Tooling, Equipment & Accessories	G General Technical	101 Male Taper Pipe Rigid	102 Female Taper Pipe Rigid	103 Male (JIC) 37° Rigid	104 Male SAE 45° Rigid	105 Male Str. Thread O-ring
							 E-37	 E-37	 E-38	 E-38	 E-39
							106 SAE (JIC) 37° Swivel	107 Female Pipe Swivel	108 Female SAE 45° Swivel	10C M FM Swivel 24° O-ring 45° Elb. Lt.	11C M FM Swivel 24° O-ring 90° Elb. Lt.
							 E-39	 E-40	 E-40	METRIC  E-49	METRIC  E-49
							112 SAE Flareless Swivel	113 Male Pipe Swivel	13E Male (JIC) 37° Long	137 FM JIC 37° Swivel 45° Elbow	139 FM JIC 37° Swivel 90° Elb. Short Drop
							 E-40	 E-41	 E-41	 E-42	 E-42
							141 Female JIC 37° Swivel 90° Elbow-Lg	149 M Banjo Union	167 SAE Male Inverted Swivel 45° Elbow	169 SAE Male Inverted Swivel 90° Elbow	192 FM BSP Parallel Pipe Swivel Str.
							 E-43	METRIC  E-44	 E-43	 E-43	 E-50
							1AL A-Lok Compression	1B1 Female BSP Pipe Swivel 45° Elb. (60° Cone)	1B2 Female BSP Pipe Swivel 90° Elb. (60° Cone)	1B4 FM BSP Swivel 90° Elb. Block Type (60° Cone)	1C3 M FM Swivel Nut Light
							 E-49	 E-50	 E-51	 E-51	METRIC  E-52
							1C4 M FM Swivel 45° Elbow Lt.	1C5 M FM Swivel 90° Elbow Lt.	1C6 M FM Swivel DIN 20078 HW w/o O-ring	1C9 M FM Swivel DIN 20078 HW O-ring	1CA M FM Swivel 24° Lt. O-ring
							METRIC  E-52	METRIC  E-53	METRIC  E-53	METRIC  E-54	METRIC  E-54
							1CE M FM Swivel 24° O-ring 45° Elb.	1CF M FM Swivel 24° O-ring 90° Elb.	1D0 M Male Stud DIN 20078 Lt.	1D2 M Male Stud 24° Lt.	1D9 Male BSPP - Str. (60° Cone)
							METRIC  E-55	METRIC  E-55	METRIC  E-56	METRIC  E-56	METRIC  E-57

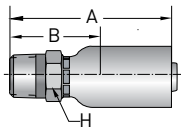
56 Series PERMANENT	1J0	Male Seal-Lok™ Rigid Str. w/O-ring	1J1	Female Seal-Lok™ 90° Elbow Long	1J2	Female Seal-Lok™ 30° Elbow	1J5	Female Seal-Lok™ 90° Elbow Med.	1J7	Female Seal-Lok™ 45° Elbow	
											
	E-46		E-46		E-46		E-47		E-47		
	1J9	Female Seal-Lok™ 90° Elbow Short	1JC	Female Seal-Lok™ Str. Swivel Short	1JS	Female Seal-Lok™ Straight	1L9	Female JIC 37° Swivel 90° Elb. Med.	1TU		Universal Inch Tube Stub End
											
E-48		E-45		E-45		E-44		E-48			

10156 Male Taper Pipe Rigid





Part Number	Thread Size	Hose I.D.		A		Cutoff Allow. B		H Hex
		inch	mm	inch	mm	inch	mm	inch
#								
10156-2-3	1/8-27	3/16	5	1.60	41	7/8	22	9/16
10156-4-3	1/4-18	3/16	5	1.82	46	1-1/8	28	9/16
10156-4-4	1/4-18	1/4	6	2.09	53	1-1/8	28	9/16
10156-4-6	1/4-18	3/8	10	2.16	55	1-3/16	30	11/16
10156-6-6	3/8-18	3/8	10	2.16	55	1-3/16	30	3/4
10156-8-8	1/2-14	1/2	13	2.55	65	1-7/16	37	7/8
10156-12-10	3/4-14	5/8	16	2.88	73	1-9/16	40	1-1/8
10156-12-12	3/4-14	3/4	19	2.97	75	1-5/8	41	1-1/16
10156-16-16	1-11-1/2	1	25	3.76	96	1-7/8	48	1-3/8

Construction: Steel.
 Add "C" for Stainless Steel.
 Note: Metric hex parts are available upon request.

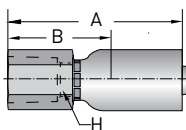
10256 Female Taper Pipe Rigid

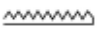

Part Number	Thread Size	Hose I.D.		A		Cutoff Allow. B		H Hex
		inch	mm	inch	mm	inch	mm	inch
#								
10256-4-4	1/4-18	1/4	6	1.99	51	1	25	11/16

Construction: Steel.
 Add "C" for Stainless Steel.

For detailed ordering information, please consult price list or contact Parflex® Division.

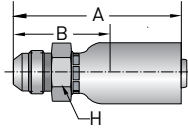

A Hose
 B Tubing
 C Coiled Air Hose & Fittings
 D Transportation
 E Fittings Series 56
 F Tooling, Equipment & Accessories
 G General Technical

A
Hose**10356 Male (JIC) 37° - Rigid**

Part Number	Thread Size	Hose I.D.		A		Cutoff Allow. B		H Hex
		inch	mm	inch	mm	inch	mm	inch
#								
10356-4-3	7/16-20	3/16	5	1.83	46	1-1/8	28	9/16
10356-4-4	7/16-20	1/4	6	2.10	53	1-1/8	28	9/16
10356-5-4	1/2-20	1/4	6	2.10	53	1-1/8	28	9/16
10356-6-4	9/16-18	1/4	6	2.14	54	1-3/16	30	11/16
10356-6-5	9/16-18	5/16	8	2.22	56	1-3/16	30	11/16
10356-5-6	1/2-20	3/8	10	2.14	54	1-1/8	28	5/8
10356-6-6	9/16-18	3/8	10	2.15	55	1-3/16	30	5/8
10356-8-6	3/4-16	3/8	10	2.25	57	1-1/4	32	13/16
10356-8-8	3/4-16	1/2	13	2.40	61	1-5/16	33	7/8
10356-10-8	7/8-14	1/2	13	2.60	66	1-1/2	38	15/16
10356-12-10	1-1/16-12	5/8	16	2.97	75	1-5/8	42	1-1/8
10356-12-12	1-1/16-12	3/4	19	3.07	78	1-3/4	44	1-1/8
10356-16-16	1-5/16-12	1	25	3.66	93	1-3/4	44	1-3/8

Construction: Steel.

Add "C" for Stainless Steel.

Note: Metric hex parts are available upon request.

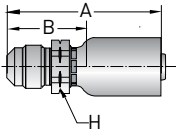
B
TubingC
Coiled Air Hose
& FittingsD
TransportationE
Fittings
Series 56F
Tooling, Equipment
& AccessoriesG
General Technical**10456 Male SAE 45° - Rigid**

Part Number	Thread Size	Hose I.D.		A		Cutoff Allow. B		H Hex
		inch	mm	inch	mm	inch	mm	inch
#								
10456-4-3	7/16-20	3/16	5	1.71	43	1	25	9/16
10456-5-4	1/2-20	1/4	6	2.11	54	1-1/8	28	9/16
10456-6-5	5/8-18	5/16	8	2.18	55	1-3/16	30	11/16
10456-6-6	5/8-18	1/2	13	2.16	55	1-3/16	30	11/16
10456-6-8	5/8-18	1/2	13	2.37	60	1-1/4	32	3/4
10456-8-8	3/4-16	1/2	13	0.25	64	1-3/8	35	7/8
10456-12-12	1-1/16-14	3/4	19	3.11	79	1-3/4	44	1-1/8

Construction: Steel.

Add "C" for Stainless Steel.

10556 Male Straight Thread O-ring (BUNA N O-ring included)

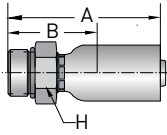

Part Number	Thread Size	Hose I.D.		A		Cutoff Allow. B		H Hex
		inch	mm	inch	mm	inch	mm	inch
#								
10556-4-3	7/16-20	3/16	4	1.61	41	15/16	24	9/16
10556-6-3	9/16-18	3/16	4	1.64	42	15/16	24	11/16
10556-4-4	7/16-20	1/4	6	1.84	47	7/8	22	9/16
10556-5-4	1/2-20	1/4	6	1.84	47	7/8	22	5/8
10556-6-4	9/16-18	1/4	6	1.91	49	15/16	24	11/16
10556-4-5	7/16-20	5/16	8	1.91	49	7/8	22	5/8
10556-5-5	1/2-20	5/16	8	1.91	49	7/8	22	5/8
10556-6-6	9/16-18	3/8	10	1.95	50	15/16	24	11/16
10556-8-6	3/4-16	3/8	10	1.98	50	1	25	7/8
10556-8-8	3/4-16	1/2	12	2.21	56	1-1/8	28	7/8
10556-10-8	7/8-14	1/2	12	2.28	58	1-3/16	30	1

Construction: Steel.

Add "C" for Stainless Steel.

Note: Metric hex parts are available upon request.

10656 SAE (JIC) 37° Swivel

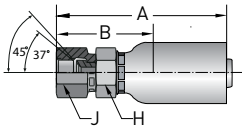

Part Number	Thread Size	Hose I.D.		A		Cutoff Allow. B		H Hex	J Hex
		inch	mm	inch	mm	inch	mm	inch	inch
#									
10656-3-3	3/8-24	3/16	5	1.91	49	1-3/16	30	1/2	1/2
10656-4-3	7/16-20	3/16	5	1.78	45	1-1/16	27	9/16	9/16
10656-5-3	1/2-20	3/16	5	1.84	47	1-1/8	28	9/16	5/8
10656-2-4	3/8-24	1/4	6	1.98	50	1	25	1/2	7/16
10656-4-4	7/16-20	1/4	6	2.05	52	1-1/16	27	9/16	9/16
10656-5-4	1/2-20	1/4	6	2.12	54	1-1/8	28	9/16	5/8
10656-6-4	9/16-18	1/4	6	2.14	54	1-3/16	30	11/16	9/16
10656-4-5	7/16-20	5/16	8	2.10	53	1-1/16	27	9/16	9/16
10656-5-5	1/2-20	5/16	8	2.21	56	1-3/16	30	5/8	5/8
10656-6-5	9/16-18	5/16	8	2.23	57	1-3/16	30	5/8	11/16
10656-4-6	7/16-20	3/8	10	2.09	53	1-1/8	28	9/16	9/16
10656-5-6	1/2-20	3/8	10	2.23	57	1-1/4	32	5/8	5/8
10656-6-6	9/16-18	3/8	10	2.22	56	1-1/4	32	11/16	11/16
10656-8-6	3/4-16	3/8	10	2.37	60	1-3/8	35	11/16	7/8
10656-6-8	9/16-18	1/2	13	2.42	61	1-5/16	33	3/4	11/16
10656-8-8	3/4-16	1/2	13	2.54	64	1-7/16	36	13/16	7/8
10656-10-8	7/8-14	1/2	13	2.64	67	1-1/2	38	7/8	1
10656-8-10	3/4-16	5/8	16	2.73	69	1-7/16	36	15/16	7/8
10656-10-10	7/8-14	5/8	16	2.99	76	1-11/16	43	15/16	1
10656-12-10	1-1/16-12	5/8	16	3.06	78	1-3/4	44	1-1/16	1-1/4
10656-10-12	7/8-14	3/4	19	2.88	73	1-1/2	38	1-1/16	1
10656-12-12	1-1/16-12	3/4	19	3.06	78	1-3/4	44	1-1/16	1-1/4
10656-16-12	1-5/16-12	3/4	19	3.27	83	1-15/16	49	1-1/4	1-1/2
10656-16-16	1-5/16-12	1	25	3.81	97	1-15/16	49	1-3/8	1-1/2
10656-20-16	1-5/8-12	1	25	3.96	101	2-1/16	52	1-5/8	2

Construction: Steel. Add "C" for Stainless Steel.

Note: Metric hex parts are available upon request. Sizes -4, -5, -8 and -10 incorporate a dual seat.

For detailed ordering information, please consult price list or contact Parflex® Division.

Parker Hannifin Corporation | Parflex® Division | Ravenna, Ohio | parker.com/pfd

www.comoso.com

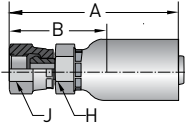

A
Hose**10756 Female Pipe Swivel**

Part Number	Thread Size	Hose I.D.		A		Cutoff Allow. B		H Hex	J Hex
		inch	mm	inch	mm	inch	mm	inch	inch
#									
10756-4-4	1/4-18	1/4	6	2.03	52	1-1/16	27	9/16	11/16
10756-4-5	1/4-18	5/16	8	2.09	53	1-1/16	27	9/16	11/16
10756-6-6	3/8-18	3/8	10	2.13	54	1-1/8	28	11/16	7/8
10756-8-8	1/2-14	1/2	13	2.40	61	1-5/16	33	7/8	1
10756-12-12	3/4-14	3/4	19	2.98	76	1-5/8	41	1-1/16	1-1/4
10756-16-16	1-11-1/2	1	25	3.74	95	1-7/8	48	1-3/8	1-1/2

Construction: Steel.

Add "C" for Stainless Steel.

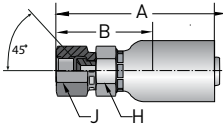
B
TubingC
Coiled Air Hose
& Fittings**10856 Female SAE 45° Swivel**

Part Number	Thread Size	Hose I.D.		A		Cutoff Allow. B		H Hex	J Hex
		inch	mm	inch	mm	inch	mm	inch	inch
#									
10856-6-4	5/8-18	1/4	6	2.19	56	1-1/4	32	11/16	3/4
10856-6-5	5/8-18	5/16	8	2.28	58	1-1/4	32	11/16	3/4
10856-6-6	5/8-18	3/8	10	2.36	60	1-3/8	35	11/16	3/4
10856-12-12	1-1/16-14	3/4	19	3.06	78	1-3/4	44	1-1/16	1-1/4

Construction: Steel.

Add "C" for Stainless Steel.

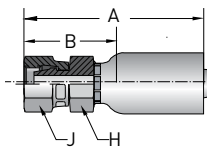
D
TransportationE
Fittings
Series 56**11256 SAE Flareless Swivel**

Part Number	Thread Size	Hose I.D.		A		Cutoff Allow. B		H Hex	J Hex
		inch	mm	inch	mm	inch	mm	inch	inch
#									
11256-6-4	9/16-18	1/4	6	2.14	54	1-3/16	30	11/16	9/16
11256-6-6	9/16-18	3/8	10	2.22	56	1-1/4	32	11/16	11/16
11256-8-6	3/4-16	3/8	10	2.37	60	1-3/8	35	11/16	7/8

Construction: Steel.

Add "C" for Stainless Steel.

F
Tooling, Equipment
& AccessoriesG
General Technical

11356 Male Pipe Swivel

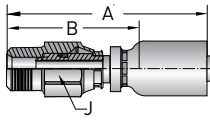

Part Number	Thread Size	Hose I.D.		A		Cutoff Allow. B		J Hex
		inch	mm	inch	mm	inch	mm	inch
#								
11356-2-3	1/8-27	3/16	5	2.85	73	2-1/8	54	5/8
11356-4-3	1/4-18	3/16	5	2.59	66	1-7/8	48	5/8
11356-4-4	1/4-18	1/4	6	2.95	75	2	50	5/8
11356-4-5	1/4-18	5/16	8	2.95	75	1-15/16	49	5/8
11356-6-6	3/8-18	3/8	10	3.06	78	2-1/16	52	3/4
11356-8-6	1/2-14	3/8	10	3.24	82	2-1/4	57	7/8
11356-8-8	1/2-14	1/2	13	3.37	86	2-1/4	57	7/8
11356-12-12	3/4-14	3/4	19	3.71	94	2-3/8	60	1-1/4
11356-16-16	1-11-1/2	1	25	4.64	118	2-3/4	70	1-1/2

Construction: Steel.

Add "C" for Stainless Steel.

NOTE: For use with petroleum based fluids.

WARNING: Fittings allow minor movement to relieve stress on hose but are not recommended for continued or extensive swiveling. Not recommended for use in CNG applications.

13E56 Male (JIC) 37° Long

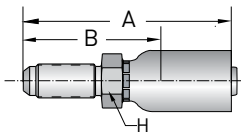

Part Number	Thread Size	Hose I.D.		A		Cutoff Allow. B		H Hex
		inch	mm	inch	mm	inch	mm	inch
#								
13E56-4-4	7/16-20	1/4	6	2.80	71	1-13/16	46	5/8
13E56-6-5	9/16-18	5/16	8	2.97	75	1-15/16	49	3/4
13E56-6-6	9/16-18	3/8	10	2.97	75	2	50	7/8
13E56-8-8	3/4-16	1/2	13	3.24	82	2-1/8	54	7/8

Construction: Steel.

Add "C" for Stainless Steel.

NOTE: Bulkhead Locknut sold separately. WLN Locknuts are manufactured by the Tube Fittings Division. Refer to Catalog 4300 for additional information.

For detailed ordering information, please consult price list or contact Parflex® Division.

Parker Hannifin Corporation | Parflex® Division | Ravenna, Ohio | parker.com/pfd

www.comoso.com



E-41

A
Hose

B
Tubing

C
Coiled Air Hose
& Fittings

D
Transportation

E
Fittings
Series 56

F
Tooling, Equipment
& Accessories

G
General Technical

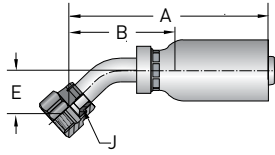
A
Hose**13756 Female JIC 37° Swivel 45° Elbow**

Part Number	Thread Size	Hose I.D.		A		Cutoff Allow. B		E		J Hex
		inch	mm	inch	mm	inch	mm	inch	mm	inch
#										
13756-4-3	7/16-20	3/16	5	1.93	49	1-1/4	32	.39	10	9/16
13756-4-4	7/16-20	1/4	6	2.19	56	1-1/4	32	.39	10	9/16
13756-5-4	1/2-20	1/4	6	2.46	62	1-1/2	38	.39	10	5/8
13756-6-4	9/16-18	1/4	6	2.24	57	1-1/4	32	.43	11	11/16
13756-6-5	9/16-18	5/16	8	2.53	64	1-1/2	38	.43	11	11/16
13756-6-6	9/16-18	3/8	10	2.57	65	1-9/16	40	.43	11	11/16
13756-8-6	3/4-16	3/8	10	2.76	70	1-3/4	44	.59	15	7/8
13756-8-8	3/4-16	1/2	13	2.72	69	1-5/8	41	.59	15	7/8
13756-10-8	7/8-14	1/2	13	2.87	73	1-3/4	45	.63	16	1
13756-10-10	7/8-14	5/8	16	3.23	83	2	50	.63	16	1
13756-12-10	1-1/16-12	5/8	16	3.74	95	2.40	61	.83	21	1-1/4
13756-12-12	1-1/16-12	3/4	19	3.86	98	2-1/2	64	.83	21	1-1/4
13756-16-16	1-5/16-12	1	25	4.53	115	2.63	67	.94	24	1-1/2

Construction: Steel.

Add "C" for Stainless Steel.

Note: Metric hex parts are available upon request.

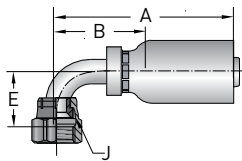
B
TubingC
Coiled Air Hose
& FittingsD
Transportation**13956 Female JIC 37° Swivel 90° Elbow Short Drop**

Part Number	Thread Size	Hose I.D.		A		Cutoff Allow. B		E		J Hex
		inch	mm	inch	mm	inch	mm	inch	mm	inch
#										
13956-4-3	7/16-20	3/16	5	1.75	44	1-1/16	27	.83	21	9/16
13956-4-4	7/16-20	1/4	6	2.01	51	1-1/16	27	.83	21	9/16
13956-5-4	1/2-20	1/4	6	2.01	51	1-1/16	27	.83	21	9/16
13956-6-4	9/16-18	1/4	6	2.01	51	1-1/16	27	.91	23	11/16
13956-6-5	9/16-18	5/16	8	2.14	54	1-1/8	28	.91	23	11/16
13956-6-6	9/16-18	3/8	10	2.22	56	1-1/4	32	.91	23	11/16
13956-8-6	3/4-16	3/8	10	2.55	65	1-9/16	40	1.14	29	7/8
13956-8-8	3/4-16	1/2	13	2.48	63	1-3/8	35	1.14	29	7/8
13956-10-8	7/8-14	1/2	13	2.60	66	1-1/2	38	1.26	32	1
13956-10-10	7/8-14	5/8	16	3.08	78	1-3/4	45	1.26	32	1
13956-12-10	1-1/16-12	5/8	19	3.39	86	2-1/16	52	1.89	48	1-1/4
13956-12-12	1-1/16-12	3/4	19	3.71	94	2-3/8	60	1.89	48	1-1/4
13956-16-16	1-5/16-12	1	25	4.50	114	2.60	66	2.20	56	1-1/2

Construction: Steel.

Add "C" for Stainless Steel.

Note: Metric hex parts are available upon request.

E
Fittings
Series 56F
Tooling, Equipment
& AccessoriesG
General Technical

14156 Female JIC 37° Swivel 90° Elbow Long Drop

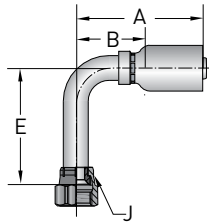

Part Number	Thread Size	Hose I.D.		A		Cutoff Allow. B		E		J Hex
		inch	mm	inch	mm	inch	mm	inch	mm	inch
#										
14156-4-3	7/16-20	3/16	5	1.73	44	1-1/16	27	1.81	46	9/16
14156-4-4	7/16-20	1/4	6	2.01	51	1-1/16	27	1.81	46	9/16
14156-5-4	1/2-20	1/4	6	2.01	51	1-1/16	27	1.81	46	5/8
14156-6-4	9/16-18	1/4	6	2.01	51	1-1/16	27	2.13	54	11/16
14156-6-5	9/16-18	5/16	8	2.14	54	1-1/8	28	2.13	54	11/16
14156-6-6	9/16-18	3/8	10	2.22	56	1-1/4	32	2.13	54	11/16
14156-8-6	3/4-16	3/8	10	2.22	56	1-1/4	32	2.52	64	7/8
14156-8-8	3/4-16	1/2	13	2.48	63	1-3/8	35	2.52	64	7/8
14156-10-8	7/8-14	1/2	13	2.48	63	1-3/8	35	2.76	70	1
14156-12-12	1-1/16-12	3/4	19	3.59	91	2-1/4	57	3.78	96	1-1/4
14156-16-16	1-5/16-12	1	25	4.36	111	2-1/2	63	4.49	114	1-1/2

Construction: Steel.

Add "C" for Stainless Steel.

16756 SAE Male Inverted Swivel 45° Elbow

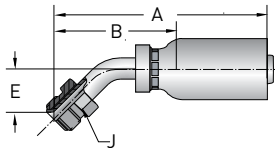

Part Number	Thread Size	Hose I.D.		A		Cutoff Allow. B		E		J Hex
		inch	mm	inch	mm	inch	mm	inch	mm	inch
#										
16756-6-6	5/8-18	3/8	10	2.90	74	1-3/4	44	.94	24	5/8

Construction: Steel.

Add "C" for Stainless Steel.

16956 SAE Male Inverted Swivel 90° Elbow

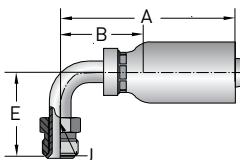

Part Number	Thread Size	Hose I.D.		A		Cutoff Allow. B		E		J Hex
		inch	mm	inch	mm	inch	mm	inch	mm	inch
#										
16956-6-6	5/8-18	3/8	10	1.65	42	1-9/16	40	1.70	43	5/8

Construction: Steel.

Add "C" for Stainless Steel.

For detailed ordering information, please consult price list or contact Parflex® Division.

Parker Hannifin Corporation | Parflex® Division | Ravenna, Ohio | parker.com/pfd

www.comoso.com



A Hose

B Tubing

C Coiled Air Hose & Fittings

D Transportation

E Fittings Series 56

F Tooling, Equipment & Accessories

G General Technical

A Hose

1L956 Female JIC 37° Swivel 90° Elbow Medium Drop

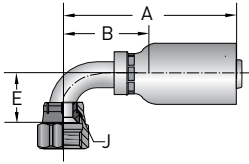

B Tubing

Part Number	Thread Size	Hose I.D.		A		Cutoff Allow. B		E		J Hex
		inch	mm	inch	mm	inch	mm	inch	mm	inch
#										
1L956-4-3	7/16-20	3/16	5	1.75	44	1-1/16	27	1.26	32	9/16
1L956-4-4	7/16-20	1/4	6	2.01	51	1-1/16	27	1.26	32	9/16
1L956-5-4	1/2-20	1/4	6	2.01	51	1-1/16	27	1.26	32	5/8
1L956-6-5	9/16-18	5/16	8	2.14	54	1-1/8	28	1.50	38	11/16
1L956-6-6	9/16-18	3/8	10	2.22	56	1-1/4	32	1.50	38	11/16
1L956-8-6	3/4-16	3/8	10	2.22	56	1-1/4	32	1.61	41	7/8
1L956-8-8	3/4-16	1/2	13	2.48	63	1-3/8	35	1.61	41	7/8
1L956-10-8	7/8-14	1/2	13	2.48	63	1-3/8	35	1.85	47	1
1L956-12-12	1-1/16-12	3/4	19	3.59	91	2-1/4	57	2.28	58	1-1/4
1L956-16-16	1-5/16-12	1	25	4.36	111	2-1/2	63	2.80	71	1-1/2

Construction: Steel.

Add "C" for Stainless Steel.

C Coiled Air Hose & Fittings

D Transportation

14956 – Banjo Union DIN 7642

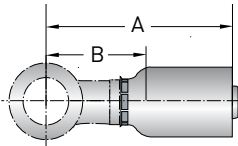

Part Number	Diameter R	Hose I.D.		A		Cutoff Allow. B	
		mm	inch	mm	inch	mm	inch
#							
14956-14-3	14	5	3/16	49	1.93	31	1.22
14956-12-4	12	6	1/4	50	1.97	25	1.50
14956-14-4	14	6	1/4	56	2.20	32	1.26
14956-12-5	12	8	5/16	54	2.13	29	1.14
14956-14-5	14	8	5/16	53	2.09	27	1.06
14956-16-6	16	10	3/8	58	2.28	33	1.30
14956-17-6	17	10	3/8	55	2.17	29	1.14

Construction: Steel.

E Fittings Series 56

F Tooling, Equipment & Accessories

G General Technical



1JS56 Female Seal-Lok™ Straight

ISO 12151-1-SWSB

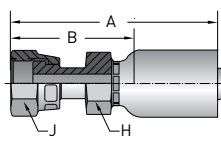

Part Number	Thread Size	Hose I.D.		A		Cutoff Allow. B		H Hex		J Hex	
		inch	mm	inch	mm	inch	mm	inch	mm	inch	mm
#											
1JS56-4-3	9/16-18	3/16	5	1.89	48	1-3/16	30	9/16		11/16	
1JS56-4-4	9/16-18	1/4	6	2.17	51	1-3/16	30	9/16		11/16	
1JS56-6-4	11/16-16	1/4	6	2.24	57	1-1/4	32	11/16		13/16	
1JS56-6-5	11/16-16	5/16	8	2.29	58	1-1/4	32	11/16		13/16	
1JS56-6-6	11/16-16	3/8	10	2.28	58	1-5/16	33	11/16		13/16	
1JS56-8-6	13/16-16	3/8	10	2.40	61	1-7/16	36	13/16		15/16	
1JS56-6-8	11/16-16	1/2	13	2.40	61	1-5/16	33	3/4		13/16	
1JS56-8-8	13/16-16	1/2	13	2.52	64	1-3/8	35	13/16		15/16	
1JS56-10-8	1-14	1/2	13	2.68	68	1-9/16	40	15/16		1-1/8	
1JS56-10-10	1-14	5/8	16	2.92	74	1-5/8	41	15/16		1-1/8	
1JS56-12-12	1-3/16-12	3/4	19	3.17	81	1-13/16	46	1-1/8		1-3/8	
1JS56-16-16	1-7/16-12	1	25	3.76	96	1-7/8	48	1-3/8		1-5/8	

Construction: Steel.

Add "C" for Stainless Steel.

Note: Metric hex parts are available upon request.

1JC56 Female Seal-Lok™ Straight - Swivel - Short

ISO 12151-1-SWSA

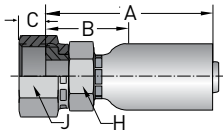

Part Number	Thread Size	Hose I.D.		A		Cutoff Allow. B		C		H Hex		J Hex	
		inch	mm	inch	mm	inch	mm	inch	mm	inch	mm	inch	mm
#													
1JC56-4-3	9/16-18	3/16	5	1.58	40	7/8	22	.32	8	9/16		11/16	
1JC56-4-4	9/16-18	1/4	6	1.86	47	7/8	22	.32	8	9/16		11/16	
1JC56-6-4	11/16-16	1/4	6	1.90	48	15/16	24	.34	9	11/16		13/16	
1JC56-4-5	9/16-18	5/16	8	1.81	46	13/16	21	.32	8	11/16		11/16	
1JC56-6-5	11/16-16	5/16	8	1.95	49	15/16	24	.34	9	11/16		13/16	
1JC56-4-6	9/16-18	3/8	10	1.91	48	15/16	24	.32	8	5/8		11/16	
1JC56-6-6	11/16-16	3/8	10	1.89	48	7/8	22	.34	9	11/16		13/16	
1JC56-8-6	13/16-16	3/8	10	2.00	51	1	25	.43	11	13/16		15/16	
1JC56-8-8	13/16-16	1/2	13	2.13	54	1	25	.43	11	13/16		15/16	
1JC56-10-8	1-14	1/2	13	2.30	58	1-3/16	30	.48	12	15/16		1-1/8	
1JC56-10-10	1-14	5/8	16	2.48	63	1-3/16	30	.48	12	15/16		1-1/8	
1JC56-12-10	1-3/16-12	5/8	16	2.61	66	1-5/16	33	.55	14	1-1/8		1-3/8	
1JC56-10-12	1-14	3/4	19	2.50	64	1-3/16	30	.48	12	1-1/8		1-1/8	
1JC56-12-12	1-3/16-12	3/4	19	2.54	65	1-3/16	30	.55	14	1-1/8		1-3/8	
1JC56-16-16	1-7/16-12	1	25	3.21	82	1-5/16	33	.56	14	1-3/8		1-5/8	

Construction: Steel.

Add "C" for Stainless Steel.

Note: Metric hex parts are available upon request.

For detailed ordering information, please consult price list or contact Parflex® Division.

Parker Hannifin Corporation | Parflex® Division | Ravenna, Ohio | parker.com/pfd

www.comoso.com



E-45

A
Hose

B
Tubing

C
Coiled Air Hose
& Fittings

D
Transportation

E
Fittings
Series 56

F
Tooling, Equipment
& Accessories

G
General Technical

A
Hose

1J056 Male Seal-Lok™ Rigid Straight w/O-ring ISO 12151-1-S

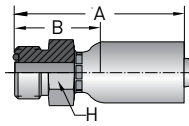

Part Number	Thread Size	Hose I.D.		A		Cutoff Allow. B		H Hex
		inch	mm	inch	mm	inch	mm	inch
#								
1J056-4-4	9/16-18	1/4	6	1.93	49	15/16	24	5/8
1J056-6-4	11/16-16	1/4	6	2.01	51	1-1/16	27	3/4
1J056-6-6	11/16-16	3/8	10	1.98	50	1	25	3/4
1J056-8-6	13/16-16	1/2	13	2.16	55	1-3/16	30	7/8
1J056-8-8	13/16-16	1/2	13	2.18	55	1-1/16	27	7/8

Construction: Steel.

Add "C" for Stainless Steel.

Note: Metric hex parts are available upon request.

B
TubingC
Coiled Air Hose
& Fittings

1J156 Female Seal-Lok™ Swivel 90° Elbow Long Drop ISO 12151-1-SWEL90

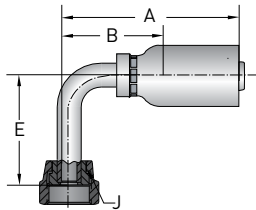

Part Number	Thread Size	Hose I.D.		A		Cutoff Allow. B		E		J Hex
		inch	mm	inch	mm	inch	mm	inch	mm	inch
#										
1J156-4-3	9/16-18	3/16	5	1.89	48	1-3/16	30	1.81	46	11/16
1J156-4-4	9/16-18	1/4	6	2.09	53	1-1/8	28	1.81	46	11/16
1J156-6-4	11/16-16	1/4	6	2.09	53	1-1/8	28	2.13	54	13/16
1J156-6-6	11/16-16	3/8	10	2.22	56	1-1/4	32	2.13	54	13/16
1J156-8-6	13/16-16	3/8	10	2.22	56	1-1/4	32	2.52	64	15/16
1J156-8-8	13/16-16	1/2	13	2.48	63	1-3/8	35	2.52	64	15/16
1J156-12-12	1-3/16-12	3/4	19	3.59	91	2-1/4	57	3.78	96	1-3/8
1J156-16-16	1-7/16-12	1	25	4.36	111	2-1/2	63	4.49	114	1-5/8

Construction: Steel.

Add "C" for Stainless Steel.

Note: Metric hex parts are available upon request.

D
TransportationE
Fittings
Series 56

1J256 Female Seal-Lok™ Swivel 30° Elbow

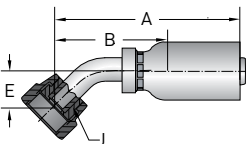

Part Number	Thread Size	Hose I.D.		A		Cutoff Allow. B		E		J Hex
		inch	mm	inch	mm	inch	mm	inch	mm	inch
#										
1J256-8-8	13/16-16	1/2	13	2.84	72	1-11/16	43	.43	11	15/16

Construction: Steel.

Add "C" for Stainless Steel.

F
Tooling, Equipment
& AccessoriesG
General Technical

1J556 Female Seal-Lok™ Swivel 90° Elbow Medium Drop

ISO 12151-1-SWEM90

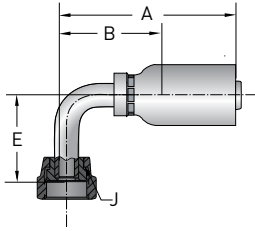

Part Number	Thread Size	Hose I.D.		A		Cutoff Allow. B		E		J Hex
		inch	mm	inch	mm	inch	mm	inch	mm	inch
#										
1J556-4-3	9/16-18	3/16	5	1.89	48	1-3/16	30	1.26	32	11/16
1J556-4-4	9/16-18	1/4	6	2.14	53	1-1/8	28	1.26	32	11/16
1J556-6-4	11/16-16	1/4	6	2.14	55	1-3/16	30	1.50	38	13/16
1J556-6-5	11/16-16	5/16	8	2.28	58	1-1/4	32	1.50	38	13/16
1J556-6-6	11/16-16	3/8	10	2.22	56	1-1/4	32	1.50	38	13/16
1J556-8-6	13/16-16	3/8	10	2.22	56	1-1/4	32	1.61	41	15/16
1J556-8-8	13/16-16	1/2	13	2.48	63	1-3/8	35	1.61	41	15/16
1J556-10-8	1-14	1/2	13	2.48	63	1-3/8	35	1.85	47	1-1/8
1J556-10-10	1-14	5/8	16	2.83	72	1-1/2	38	1.85	47	1-1/8
1J556-12-12	1-3/16-12	3/4	19	3.59	91	2-1/4	57	2.28	58	1-3/8
1J556-16-16	1-7/16-12	1	25	4.36	111	2-1/2	63	2.80	71	1-5/8

Construction: Steel.

Add "C" for Stainless Steel.

Note: Metric hex parts are available upon request.

1J756 Female Seal-Lok™ Swivel 45° Elbow

ISO 12151-1-SWE45

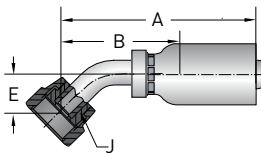

Part Number	Thread Size	Hose I.D.		A		Cutoff Allow. B		E		J Hex
		inch	mm	inch	mm	inch	mm	inch	mm	inch
#										
1J756-4-3	9/16-18	3/16	5	2.00	51	1-5/16	33	.39	10	11/16
1J756-4-4	9/16-18	1/4	6	2.25	57	1-1/4	32	.39	10	11/16
1J756-6-4	11/16-16	1/4	6	2.27	58	1-5/16	33	.43	11	13/16
1J756-6-5	11/16-16	5/16	8	2.32	59	1-3/8	35	.43	11	13/16
1J756-4-6	9/16-18	3/8	10	2.25	57	1-1/4	32	.39	10	11/16
1J756-6-6	11/16-16	3/8	10	2.35	60	1-3/8	35	.43	11	13/16
1J756-8-6	13/16-16	3/8	10	2.54	65	1-9/16	40	.59	15	15/16
1J756-8-8	13/16-16	1/2	13	2.72	69	1-5/8	41	.59	15	15/16
1J756-10-10	1-14	5/8	16	3.27	83	2	50	.63	16	1-1/8
1J756-12-12	1-3/16-12	3/4	19	3.86	98	2-1/2	64	.83	21	1-3/8
1J756-16-16	1-7/16-12	1	25	4.53	115	2.63	67	.94	24	1-5/8

Construction: Steel.

Add "C" for Stainless Steel.

Note: Metric hex parts are available upon request.

For detailed ordering information, please consult price list or contact Parflex® Division.

Parker Hannifin Corporation | Parflex® Division | Ravenna, Ohio | parker.com/pfd

www.comoso.com



E-47

A
Hose

B
Tubing

C
Coiled Air Hose
& Fittings

D
Transportation

E
Fittings
Series 56

F
Tooling, Equipment
& Accessories

G
General Technical

A
Hose

1J956 Female Seal-Lok™ Swivel 90° Elbow Short Drop ISO 12151-1-SWES90

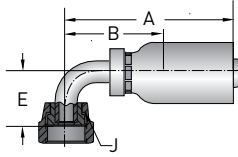

Part Number	Thread Size	Hose I.D.		A		Cutoff Allow. B		E		J Hex
		inch	mm	inch	mm	inch	mm	inch	mm	inch
#										
1J956-4-3	9/16-18	3/16	5	1.89	48	1-3/16	30	.83	21	11/16
1J956-4-4	9/16-18	1/4	6	2.14	53	1-1/8	28	.83	21	11/16
1J956-6-4	11/16-16	1/4	6	2.14	55	1-3/16	30	.91	23	13/16
1J956-6-5	11/16-16	5/16	8	2.28	58	1-1/4	32	.91	23	13/16
1J956-6-6	11/16-16	3/8	10	2.22	56	1-1/4	32	.91	23	13/16
1J956-8-6	13/16-16	3/8	10	2.22	56	1-1/4	32	1.14	29	15/16
1J956-8-8	13/16-16	1/2	13	2.48	63	1-3/8	35	1.14	29	15/16
1J956-10-8	1-14	1/2	13	2.48	63	1-3/8	35	1.26	32	1-1/8
1J956-10-10	1-14	5/8	16	3.08	78	1-3/4	45	1.26	32	1-1/8
1J956-12-12	1-3/16-12	3/4	19	3.71	94	2-3/8	60	1.89	48	1-3/8
1J956-16-16	1-7/16-12	1	25	4.50	114	2.60	66	2.20	56	1-5/8

Construction: Steel.

Add "C" for Stainless Steel.

Note: Metric hex parts are available upon request.

B
TubingC
Coiled Air Hose
& FittingsD
Transportation

1TU56 Universal Inch Tube Stub End

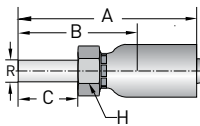

Part Number	Diameter R	Hose I.D.		A		Cutoff Allow. B		C		H Hex
		inch	mm	inch	mm	inch	mm	inch	mm	inch
#										
1TU56-4-4	1/4	1/4	6	2.35	60	1-3/8	35	.72	18	5/8
1TU56-6-4	3/8	1/4	6	2.41	61	1-7/16	36	.78	20	11/16
1TU56-6-6	3/8	3/8	10	2.46	62	1-7/16	36	.78	20	3/4
1TU56-8-8	1/2	1/2	13	2.68	68	1-9/16	40	1.03	26	3/4
1TU56-12-12	3/4	3/4	19	2.88	73	1-9/16	40	1.03	26	1
1TU56-16-16	1	1	25	4.03	102	1-7/8	48	1.03	26	1-1/4

Construction: Steel.

Add "C" for Stainless Steel.

Note: Use with A-Lok & CPI nuts, sleeves and adapters. These components are manufactured by Parker's Instrumentation Connectors Division. Refer to catalogs 4230 & 4233 for additional information.

E
Fittings
Series 56F
Tooling, Equipment
& AccessoriesG
General Technical

1AL56 A-LOK® Compression (With Nut and Ferrule)

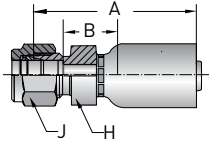

Part Number	Thread Size	Tube O.D.		Hose I.D.		A		Cutoff Allow. B		H Hex	J Hex
		inch	mm	inch	mm	inch	mm	inch	mm	inch	inch
#											
1AL56-4-4	7/16-20	1/4	6	1/4	6	1.91	49	5/8	16	9/16	9/16
1AL56-6-6	9/16-20	3/8	10	3/8	10	2.09	53	11/16	17	11/16	11/16
1AL56-8-8	3/4-20	1/2	13	3/8	10	2.21	56	5/8	16	7/8	7/8

Construction: 316 Stainless nipple and shell.

NOTE: Nut part No. is XNUX or XNUX-316 for stainless steel.
 Front ferrule part No. is XFFX or XFFX-316 for stainless steel.
 Back ferrule part No. is XBFX or XBFX-316 for stainless steel.
 X denotes dash size.

10C56 – Metric Female Swivel 24° With O-ring 45° Elbow Light Series, ISO 12151-2

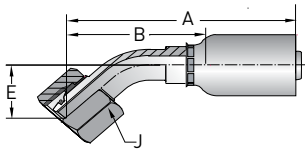

Part Number	Thread Size	Hose I.D.		A		Cutoff Allow. B		E		J Hex
		mm	inch	mm	inch	mm	inch	mm	inch	mm
#										
10C56-6-3	M14x1.5	5.0	3/16	58	2.28	40	1.57	16	0.63	17
10C56-8-3	M16x1.5	5	3/16	59	2.32	41	1.61	18	0.71	19
10C56-10-4	M18x1.5	6	1/4	64	2.52	40	1.57	17	0.67	22
10C56-12-5	M20x1.5	8	5/16	69	2.72	43	1.69	17	0.67	24
10C56-12-6	M20x1.5	10	3/8	75	2.95	49	1.93	20	0.79	24
10C56-16-8	M24x1.5	13	1/2	80	3.15	51	2.01	23	0.91	30

Construction: Steel.

Add "C" for Stainless Steel.

11C56 – Metric Female Swivel 24° With O-ring 90° Elbow Light Series, ISO 12151-2

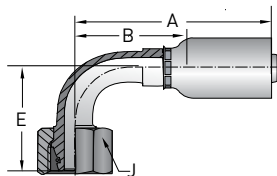

Part Number	Thread Size	Hose I.D.		A		Cutoff Allow. B		E		J Hex
		mm	inch	mm	inch	mm	inch	mm	inch	mm
#										
11C56-8-3	M16x1.5	5	3/16	48	1.89	30	1.18	29	1.14	19
11C56-10-4	M18x1.5	6	1/4	53	2.09	29	1.14	32	1.26	22
11C56-12-5	M20x1.5	8	5/16	65	2.56	39	1.54	34	1.34	24
11C56-12-6	M20x1.5	10	3/8	63	2.48	38	1.50	37	1.46	24
11C56-16-8	M24x1.5	13	1/2	68	2.68	40	1.57	45	1.77	30

Construction: Steel.

Add "C" for Stainless Steel.

For detailed ordering information, please consult price list or contact Parflex® Division.

Parker Hannifin Corporation | Parflex® Division | Ravenna, Ohio | parker.com/pfd

www.comoso.com



E-49

A
Hose

B
Tubing

C
Coiled Air Hose
& Fittings

D
Transportation

E
Fittings
Series 56

F
Tooling, Equipment
& Accessories

G
General Technical

A
Hose

19256 Female BSP Parallel Pipe Swivel Straight (60° Cone)

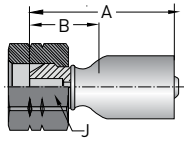
B
Tubing

Part Number	Thread Size	Hose I.D.		A		Cutoff Allow. B	
		mm	inch	mm	inch	mm	inch
#							
19256-4-3	G 1/4	5	3/16	35	1.38	17	0.67
19256-2-4	G 1/8	6	1/4	43	1.69	18	0.71
19256-4-4	G 1/4	6	1/4	42	1.65	17	0.67
19256-6-4	G 3/8	6	1/4	45	1.77	20	0.79
19256-4-5	G 1/4	8	5/16	47	1.85	21	0.83
19256-6-5	G 3/8	8	5/16	46	1.81	20	0.79
19256-6-6	G 3/8	10	3/8	46	1.81	21	0.83
19256-8-6	G 1/2	10	3/8	48	1.77	23	0.91
19256-6-8	G 3/8	13	1/2	53	2.09	25	0.98
19256-8-8	G 1/2	13	1/2	51	2.01	23	0.91
19256-10-8	G 5/8	13	1/2	49	1.93	22	0.87
19256-12-12	G 3/4	19	3/4	60	2.36	26	1.02
19256-16-16	G 1	25	1	74	2.91	26	1.02

Construction: Steel.

Add "C" for Stainless Steel.

C
Coiled Air Hose
& FittingsD
TransportationE
Fittings
Series 56

1B156 – Female BSP Parallel Pipe Swivel 45° Elbow (60° Cone) ISO 228-1

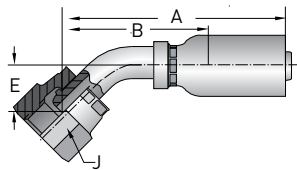

Part Number	Thread Size	Hose I.D.		A		E		Cutoff Allow. B		J Hex
		mm	inch	mm	inch	mm	inch	mm	inch	mm
#										
1B156-4-3	G 1/4	5	3/16	57	2.24	15	0.59	39	1.542	19
1B156-4-4	G 1/4	6	1/4	62	2.44	15	0.59	38	1.50	19
1B156-6-5	G 3/8	8	5/16	65	2.56	17	0.67	39	1.54	22
1B156-6-6	G 3/8	10	3/8	67	2.64	17	0.67	42	1.65	22
1B156-8-8	G 1/2	13	1/2	77	3.03	20	0.79	48	1.89	27
1B156-12-12	G 3/4	19	3/4	99	3.90	25	1.00	65	2.56	32
1B156-16-16	G 1	25	1	127	5.00	31	1.22	79	3.11	41

Construction: Steel.

Add "C" for Stainless Steel.

F
Tooling, Equipment
& AccessoriesG
General Technical

1B256 – Female BSP Parallel Pipe Swivel 90° Elbow (60° Cone) ISO 228-1

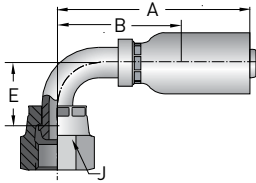

Part Number	Thread Size	Hose I.D.		A		E		Cutoff Allow. B		J Hex
		mm	inch	mm	inch	mm	inch	mm	inch	mm
#										
1B256-4-3	G 1/4	5	3/16	48	1.89	28	1.10	30	1.18	19
1B256-4-4	G 1/4	6	1/4	53	2.09	28	1.10	29	1.14	19
1B256-4-5	G 1/4	8	5/16	56	2.20	34	1.34	30	1.18	19
1B256-6-5	G 3/8	8	5/16	55	2.16	30	1.18	30	1.18	22
1B256-6-6	G 3/8	10	3/8	60	2.36	33	1.30	31	1.22	22
1B256-8-8	G 1/2	13	1/2	70	2.76	40	1.57	42	1.65	27
1B256-12-12	G 3/4	19	3/4	92	3.62	52	2.05	58	2.28	32
1B256-16-16	G 1	25	1	125	4.92	68	2.68	77	3.03	41

Construction: Steel.

Add "C" for Stainless Steel.

1B456 – Female BSP Swivel 90° Elbow Block Type (60° Cone) ISO 228-1

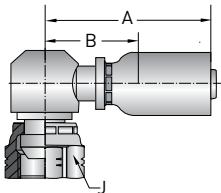

Part Number	Thread Size	Hose I.D.		A		Cutoff Allow. B		E		J Hex
		mm	inch	mm	inch	mm	inch	mm	inch	mm
#										
1B456-4-4	G 1/4	6	1/4	47	1.85	22	0.87	22	0.87	19
1B456-6-6	G 3/8	10	3/8	52	2.05	27	1.06	25	0.98	22
1B456-8-8	G 1/2	13	1/2	58	2.28	29	1.14	29	1.14	27

Construction: Steel.

For detailed ordering information, please consult price list or contact Parflex® Division.

Parker Hannifin Corporation | Parflex® Division | Ravenna, Ohio | parker.com/pfd

www.comoso.com



E-51

A
Hose

B
Tubing

C
Coiled Air Hose
& Fittings

D
Transportation

E
Fittings
Series 56

F
Tooling, Equipment
& Accessories

G
General Technical

A
Hose

1C356 – Metric Female Swivel Nut

Light Series, 24°/60°

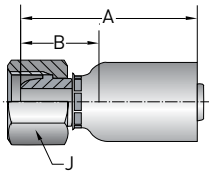

Part Number	Thread Size	Hose I.D.		A		Cutoff Allow. B		J Hex	
		mm	inch	mm	inch	mm	inch	mm	inch
#									
1C356-6-3	M12x1.5	5	3/16	37	1.46	20	0.79	14	
1C356-8-4	M14x1.5	6	1/4	44	1.73	20	0.79	17	
1C356-10-4	M16x1.5	6	1/4	45	1.77	21	0.83	19	
1C356-10-5	M16x1.5	8	5/16	46	1.81	20	0.79	19	
1C356-12-5	M18x1.5	8	5/16	47	1.85	21	0.83	22	
1C356-10-6	M16x1.5	10	3/8	46	1.81	21	0.83	19	
1C356-12-6	M18x1.5	10	3/8	47	1.85	21	0.83	22	
1C356-15-6	M22x1.5	10	3/8	46	1.81	21	0.83	27	
1C356-15-8	M22x1.5	13	1/2	50	1.97	21	0.83	27	
1C356-18-10	M26x1.5	16	5/8	57	2.24	25	0.98	32	
1C356-18-12	M26x1.5	19	3/4	58	2.28	24	0.94	32	
1C356-22-12	M30x2	19	3/4	60	2.36	27	1.06	36	

Construction: Steel.

Add "C" for Stainless Steel.

B
TubingC
Coiled Air Hose
& FittingsD
Transportation

1C456 – Metric Female Swivel 45° Elbow

Light Series, 24°/60°

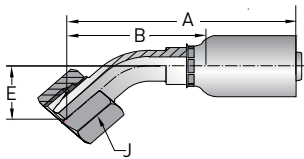

Part Number	Thread Size	Hose I.D.		A		Cutoff Allow. B		E		J Hex
		mm	inch	mm	inch	mm	inch	mm	inch	mm
#										
1C456-6-3	M12x1.5	5	3/16	57	2.24	40	1.57	16	0.63	14
1C456-8-4	M14x1.5	6	1/4	60	2.36	36	1.42	14	0.55	17
1C456-10-5	M16x1.5	8	5/16	62	2.44	37	1.46	15	0.59	19
1C456-10-6	M16x1.5	10	3/8	67	2.64	41	1.61	17	0.67	19
1C456-12-6	M18x1.5	10	3/8	72	2.83	47	1.85	18	0.71	22
1C456-15-8	M22x1.5	13	1/2	76	2.99	48	1.89	19	0.75	27

Construction: Steel.

Add "C" for Stainless Steel.

E
Fittings
Series 56F
Tooling, Equipment
& AccessoriesG
General Technical

1C556 – Metric Female Swivel 95° Elbow

Light Series, 24°/60°

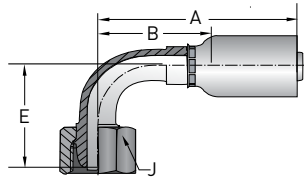

Part Number	Thread Size	Hose I.D.		A		Cutoff Allow. B		E		J Hex
		mm	inch	mm	inch	mm	inch	mm	inch	mm
#										
1C556-6-3	M12x1.5	5	3/16	48	1.89	30	1.18	30	1.18	14
1C556-8-4	M14x1.5	6	1/4	53	2.09	28	1.10	26	1.02	17
1C556-10-4	M16x1.5	6	1/4	53	2.09	28	1.10	27	1.06	19
1C556-12-5	M18x1.5	8	5/16	58	2.28	33	1.30	34	1.34	22
1C556-10-6	M16x1.5	10	3/8	63	2.48	38	1.50	33	1.30	19
1C556-12-6	M18x1.5	10	3/8	63	2.48	38	1.50	34	1.34	22
1C556-15-8	M22x1.5	13	1/2	72	2.83	44	1.73	39	1.54	27
1C556-18-12	M26x1.5	19	3/4	87	3.43	53	2.09	52	2.05	32

Construction: Steel.

Add "C" for Stainless Steel.

1C656 Female Metric Swivel DIN 20078

Heavy Series (Without O-ring) ISO 8434-1

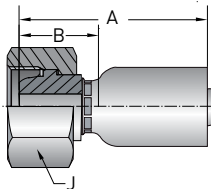

Part Number	Thread Size	Hose I.D.		A		Cutoff Allow. B		J Hex
		mm	inch	mm	inch	mm	inch	mm
#								
1C656-8-3	M16x1.5	5	3/16	38	1.50	20	0.79	19
1C656-10-4	M18x1.5	6	1/4	47	1.85	22	0.87	22
1C656-12-5	M20x1.5	8	5/16	50	1.97	24	0.94	24
1C656-12-6	M20x1.5	10	3/8	49	1.93	24	0.94	24
1C656-14-6	M22x1.5	10	3/8	49	1.93	23	0.89	27
1C656-16-8	M24x1.5	10	1/2	53	2.09	25	0.98	30
1C656-20-12	M30x2	13	3/4	61	2.40	27	1.06	36

Construction: Steel.

Add "C" for Stainless Steel.

For detailed ordering information, please consult price list or contact Parflex® Division.

Parker Hannifin Corporation | Parflex® Division | Ravenna, Ohio | parker.com/pfd

www.comoso.com



E-53

A
Hose

B
Tubing

C
Coiled Air Hose
& Fittings

D
Transportation

E
Fittings
Series 56

F
Tooling, Equipment
& Accessories

G
General Technical

A
Hose

1C956 Female Metric Swivel DIN 20078

Heavy Series, (With O-ring) ISO 12151-2-SWS

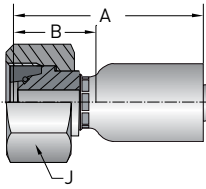

Part Number	Thread Size	Hose I.D.		A		Cutoff Allow. B		J Hex
		mm	inch	mm	inch	mm	inch	mm
#								
1C956-8-3	M16x1.5	5	3/16	41	1.61	23	0.91	19
1C956-8-4	M16x1.5	6	1/4	48	1.89	23	0.91	19
1C956-10-4	M18x1.5	6	1/4	48	1.89	23	0.91	22
1C956-12-4	M20x1.5	6	1/4	48	1.89	24	0.94	24
1C956-10-5	M18x1.5	8	5/16	49	1.93	23	0.91	22
1C956-12-5	M20x1.5	8	5/16	50	1.97	24	0.94	24
1C956-12-6	M20x1.5	10	3/8	49	1.93	24	0.94	24
1C956-14-6	M22x1.5	10	3/8	49	1.93	24	0.94	27
1C956-16-8	M24x1.5	13	1/2	56	2.17	27	1.06	30
1C956-20-12	M30x2	19	3/4	65	2.56	31	1.22	36
1C956-25-12	M36x2	19	3/4	66	2.60	32	1.30	46

Construction: Steel.

Add "C" for Stainless Steel.

B
TubingC
Coiled Air Hose
& FittingsD
Transportation

1CA56 – Metric Female Swivel 24° With O-ring

Light Series, ISO 12151-2-SWS

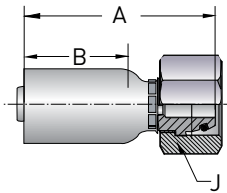

Part Number	Thread Size	Hose I.D.		A		Cutoff Allow. B		J Hex
		mm	inch	mm	inch	mm	inch	mm
#								
1CA56-6-3	M12x1.5	5	3/16	40	1.57	22	0.87	14
1CA56-6-4	M12x1.5	6	1/4	48	1.89	24	0.94	14
1CA56-8-4	M14x1.5	6	1/4	47	1.85	23	0.91	17
1CA56-10-4	M16x1.5	6	1/4	47	1.85	22	0.87	19
1CA56-12-4	M18x1.5	6	1/4	47	1.85	22	0.87	22
1CA56-10-5	M16x1.5	8	5/16	48	1.89	22	0.87	19
1CA56-12-5	M18x1.5	8	5/16	48	1.89	22	0.87	22
1CA56-10-6	M16x1.5	10	3/8	48	1.89	22	0.87	19
1CA56-12-6	M18x1.5	10	3/8	48	1.89	22	0.87	22
1CA56-15-6	M22x1.5	10	3/8	50	1.97	25	0.98	27
1CA56-12-8	M18x1.5	13	1/2	53	2.09	27	1.06	22
1CA56-15-8	M22x1.5	13	1/2	53	2.09	25	0.98	27
1CA56-18-8	M26x1.5	13	1/2	53	2.09	25	0.98	32
1CA56-18-10	M26x1.5	16	5/8	60	2.36	26	1.02	32
1CA56-18-12	M26x1.5	19	3/4	60	2.36	26	1.02	32
1CA56-22-12	M30x2	19	3/4	62	2.44	28	1.10	36
1CA56-28-16	M36x2	25	1	77	3.03	28	1.10	41

Construction: Steel.

Add "C" for Stainless Steel.

E
Fittings
Series 56F
Tooling, Equipment
& AccessoriesG
General Technical

1CE56 – Metric Female Swivel 24° With O-ring 45° Elbow Light Series, ISO 12151-2-SWE45

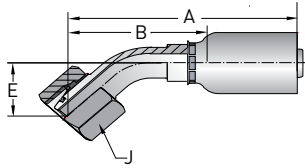

Part Number	Thread Size	Hose I.D.		A		Cutoff Allow. B		E		J Hex
		mm	inch	mm	inch	mm	inch	mm	inch	mm
#										
1CE56-6-3	M12x1.5	5	3/16	58	2.28	40	1.57	17	0.67	14
1CE56-8-4	M14x1.5	6	1/4	65	2.56	40	1.57	18	0.71	17
1CE56-10-4	M16x1.5	6	1/4	62	2.44	38	1.50	16	0.63	19
1CE56-10-5	M16x1.5	8	5/16	72	2.83	46	1.81	18	0.71	19
1CE56-10-6	M16x1.5	10	3/8	75	2.95	50	1.97	19	0.75	19
1CE56-12-6	M18x1.5	10	3/8	73	2.87	48	1.89	19	0.75	22
1CE56-15-8	M22x1.5	13	1/2	78	3.07	50	1.97	22	0.87	27
1CE56-18-10	M26x1.5	16	5/8	89	3.50	56	2.20	24	0.94	32
1CE56-18-12	M26x1.5	19	3/4	101	3.74	67	2.64	27	1.06	32
1CE56-22-12	M30x2	19	3/4	100	3.94	66	2.60	26	1.02	36
1CE56-28-16	M36x2	25	1	133	5.27	85	3.35	33	1.30	41

Construction: Steel.

Add "C" for Stainless Steel.

1CF56 – Metric Female Swivel 24° With O-ring 90° Elbow Light Series, ISO 12151-2-SWE90

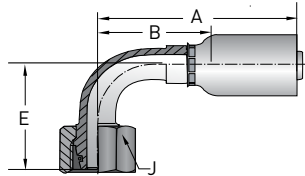

Part Number	Thread Size	Hose I.D.		A		Cutoff Allow. B		E		J Hex
		mm	inch	mm	inch	mm	inch	mm	inch	mm
#										
1CF56-6-3	M12x1.5	5	3/16	48	1.89	30	1.18	30	1.18	14
1CF56-6-4	M12x1.5	6	1/6	53	2.09	29	1.14	33	1.30	14
1CF56-8-4	M14x1.5	6	1/6	55	2.17	30	1.18	29	1.14	17
1CF56-10-4	M16x1.5	6	1/6	55	2.17	31	1.22	29	1.14	17
1CF56-10-5	M16x1.5	8	5/16	66	2.60	40	1.57	29	1.14	19
1CF56-12-5	M18x1.5	8	5/16	65	2.56	40	1.57	30	1.18	22
1CF56-10-6	M16x1.5	10	3/8	64	2.52	39	1.54	37	1.46	19
1CF56-12-6	M18x1.5	10	3/8	63	2.48	38	1.50	35	1.38	22
1CF56-15-8	M22x1.5	13	1/2	68	2.68	40	1.57	43	1.69	27
1CF56-18-10	M26x1.5	16	5/8	79	3.11	45	1.77	52	2.05	32
1CF56-22-12	M30x2	19	3/4	91	3.58	57	2.24	55	2.17	36
1CF56-28-16	M36x2	25	1	122	5.00	74	2.91	71	2.80	41

Construction: Steel.

Add "C" for Stainless Steel.

For detailed ordering information, please consult price list or contact Parflex® Division.

Parker Hannifin Corporation | Parflex® Division | Ravenna, Ohio | parker.com/pfdwww.comoso.com

E-55

A
HoseB
TubingC
Coiled Air Hose
& FittingsD
TransportationE
Fittings
Series 56F
Tooling, Equipment
& AccessoriesG
General Technical

A
Hose

1D056 - Male Stud DIN 20078

Light Series, ISO 8434-1

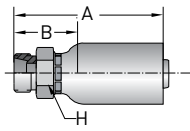

Part Number	Thread Size	Hose I.D.		A		Cutoff Allow. B		H Hex
		mm	inch	mm	inch	mm	inch	mm
#								
1D056-6-3	M12x1.5	5	3/16	41	1.61	23	0.91	12
1D056-6-4	M12x1.5	6	1/4	48	1.89	23	0.91	12
1D056-8-4	M14x1.5	6	1/4	47	1.85	23	0.91	14
1D056-10-5	M16x1.5	8	5/16	50	1.97	24	0.94	17
1D056-12-5	M18x1.5	8	5/16	52	2.05	26	1.02	19
1D056-10-6	M16x1.5	10	3/8	50	1.97	24	0.94	17
1D056-12-6	M18x1.5	10	3/8	50	1.97	24	0.94	19
1D056-15-6	M22x1.5	10	3/8	52	2.05	27	1.06	22
1D056-15-8	M22x1.5	13	1/2	55	2.16	27	1.06	22
1D056-18-10	M26x1.5	16	5/8	64	2.52	30	1.18	27
1D056-22-12	M30x2	19	3/4	68	2.68	34	1.34	30
1D056-28-16	M36x2	25	1	82	3.23	34	1.34	36

Construction: Steel.

Add "C" for Stainless Steel.

B
TubingC
Coiled Air Hose
& FittingsD
TransportationE
Fittings
Series 56F
Tooling, Equipment
& AccessoriesG
General Technical

1D256 - Metric Male Stud 24°

Light Series, ISO 12151-2

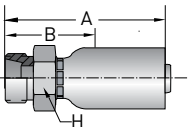

Part Number	Thread Size	Hose I.D.		A		Cutoff Allow. B		H Hex
		mm	inch	mm	inch	mm	inch	mm
#								
1D256-8-3	M16x1.5	5	3/16	42	1.65	25	0.98	17
1D256-10-4	M18x1.5	6	1/4	52	2.05	27	1.06	19
1D256-10-5	M18x1.5	8	5/16	53	2.09	27	1.06	19
1D256-12-5	M20x1.5	8	5/16	53	2.09	27	1.06	22
1D256-12-6	M20x1.5	10	3/8	53	2.09	27	1.06	22
1D256-14-6	M22x1.5	10	3/8	57	2.24	31	1.22	22
1D256-16-6	M24x1.5	10	3/8	57	2.24	31	1.22	24
1D256-16-8	M24x1.5	13	1/2	60	2.36	31	1.22	24
1D256-20-12	M30x2	19	3/4	72	2.83	38	1.50	32

Construction: Steel.

Add "C" for Stainless Steel.

1D956 Male BSPP - Straight (60° Cone) ISO 228-1

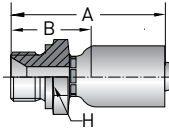

Part Number	Thread Size	Hose I.D.		A		Cutoff Allow. B		H Hex
		mm	inch	mm	inch	mm	inch	mm
#								
1D956-4-3	G 1/4	5	3/16	44	1.73	27	1.06	19
1D956-4-4	G 1/4	6	1/4	52	2.05	27	1.06	19
1D956-6-5	G 3/8	8	5/16	53	2.09	27	1.06	22
1D956-6-6	G 3/8	10	3/8	53	2.09	28	1.10	22
1D956-8-8	G 1/2	13	1/2	60	2.36	32	1.26	27
1D956-12-12	G 3/4	19	3/4	75	2.95	41	1.61	32
1D956-16-16	G 1	25	1	91	3.58	42	1.65	41

Construction: Steel.

Add "C" for Stainless Steel.

A
HoseB
TubingC
Coiled Air Hose
& FittingsD
TransportationE
Fittings
Series 56F
Tooling, Equipment
& AccessoriesG
General Technical

For detailed ordering information, please consult price list or contact Parflex® Division.

Parker Hannifin Corporation | Parflex® Division | Ravenna, Ohio | parker.com/pfd

www.comoso.com



E-57

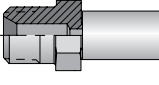
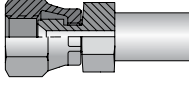
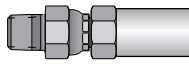
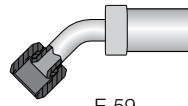
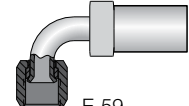
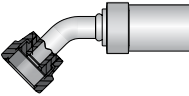
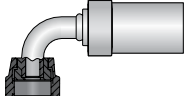
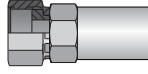

A Hose
 B Tubing
 C Coiled Air Hose & Fittings
 D Transportation
 E Fittings Series 57
 F Tooling, Equipment & Accessories
 G General Technical

57 Series Visual Index

57 Series PERMANENT	101 Male Taper Pipe Rigid	106 Female SAE (JIC) 37° Swivel	113 Male Pipe Swivel	137 FM (JIC) 37° Swivel 45° Elbow	139 FM (JIC) 37° Swivel 90° Elbow Short
	 E-58	 E-58	 E-59	 E-59	 E-59
	1J7 Seal-Lok™ 45° Elbow	1J9 Seal-Lok™ 90° Elbow	1JC Seal-Lok™ Straight Short		
	 E-60	 E-60	 E-60		

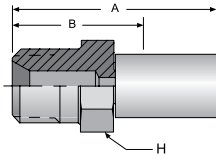
10157 Male Taper Pipe Rigid

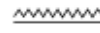



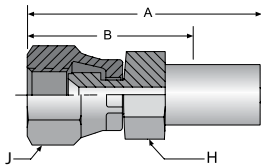

Part Number	Thread Size	Hose I.D.		A		Cutoff Allow. B		H Hex
		inch	mm	inch	mm	inch	mm	inch
#								
10157-2-2	1/8-27	1/8	3	1.35	34	3/4	19	1/2
10157-4-2	1/4-18	1/8	3	1.56	40	15/16	24	5/8

Construction: Steel.
 Add "C" for Stainless Steel.

10657 SAE (JIC) 37° Swivel



Part Number	Thread Size	Hose I.D.		A		Cutoff Allow. B		H Hex	J Hex
		inch	mm	inch	mm	inch	mm	inch	inch
#									
10657-2-2	5/16-24	1/8	3	1.63	41	1	25	1/2	1/2
10657-3-2	3/8-24	1/8	3	1.60	41	1	25	1/2	9/16
10657-4-2	7/16-20	1/8	3	1.68	43	1	25	1/2	5/8

Construction: Steel.
 Add "C" for Stainless Steel.
 NOTE: Size -4 incorporates a dual seat.

11357 Male Pipe Swivel*

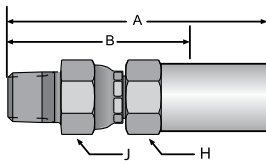

Part Number	Thread Size	Hose I.D.		A		Cutoff Allow. B		H Hex	J Hex
		inch	mm	inch	mm	inch	mm	inch	inch
#									
11357-2-2	1/8-27	1/8	3	1.96	50	1-5/16	33	1/2	1/2

Construction: Steel.

Add "C" for Stainless Steel.

NOTE: *For use with petroleum based fluids.

WARNING: Fittings allow minor movement to relieve stress on hose but are not recommended for continued or extensive swiveling.

13757 Female JIC 37° Swivel 45° Elbow

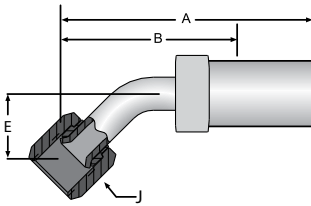

Part Number	Thread Size	Hose I.D.		A		Cutoff Allow. B		E		J Hex
		inch	mm	inch	mm	inch	mm	inch	mm	inch
#										
13757-4-2	7/16-20	1/8	3	1.98	50	1-5/16	33	0.33	8	9/16

Construction: Steel.

Add "C" for Stainless Steel.

13957 Female JIC 37° Swivel 90° Elbow Short Drop

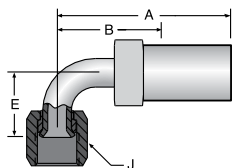

Part Number	Thread Size	Hose I.D.		A		Cutoff Allow. B		E		J Hex
		inch	mm	inch	mm	inch	mm	inch	mm	inch
#										
13957-4-2	7/16-20	1/8	3	1.87	48	1-1/4	32	0.68	17	9/16

Construction: Steel.

Add "C" for Stainless Steel.

For detailed ordering information, please consult price list or contact Parflex® Division.

Parker Hannifin Corporation | Parflex® Division | Ravenna, Ohio | parker.com/pfd

www.comoso.com



A Hose
 B Tubing
 C Coiled Air Hose & Fittings
 D Transportation
 E Fittings Series 57
 F Tooling, Equipment & Accessories
 G General Technical

A Hose

1J757 Seal-Lok™ 45° Elbow

ISO 12151-1-SWE45

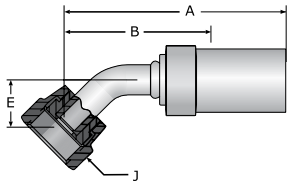

Part Number	Thread Size	Hose I.D.		A		Cutoff Allow. B		E		J Hex
		inch	mm	inch	mm	inch	mm	inch	mm	inch
1J757-4-2	9/16-18	1/8	3	2.07	53	1-7/16	36	0.39	10	11/16

Construction: Steel.

Add "C" for Stainless Steel.

B Tubing

C Coiled Air Hose & Fittings

1J957 Seal-Lok™ 90° Elbow

ISO 12151-1-SWE90

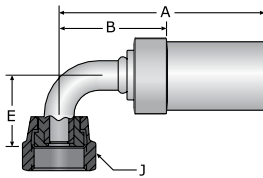

Part Number	Thread Size	Hose I.D.		A		Cutoff Allow. B		E		J Hex
		inch	mm	inch	mm	inch	mm	inch	mm	inch
1J957-4-2	9/16-18	1/8	3	2.04	52	1-7/16	36	0.83	21	11/16

Construction: Steel.

Add "C" for Stainless Steel.

D Transportation

E Fittings Series 57

1JC57 Seal-Lok™ Straight-Short

ISO 12151-1-SWSA

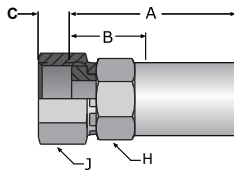

Part Number	Thread Size	Hose I.D.		A		Cutoff Allow. B		C		H Hex	J Hex
		inch	mm	inch	mm	inch	mm	inch	mm	inch	inch
1JC57-4-2	9/16-18	1/8	3	1.34	34	3/4	19	.32	8	5/8	11/16

Construction: Steel.

Add "C" for Stainless Steel.

NOTE: When measuring overall length to the end of the nut, B+C dimensions must be used to calculate cut-off allowance. Stainless steel fittings must be assembled with Karrykrimp2 or Parkimp2. See CrimpSource for more information.

F Tooling, Equipment & Accessories

G General Technical

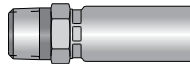
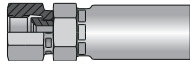
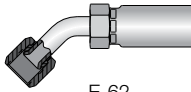
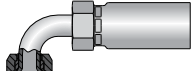
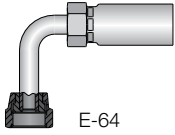
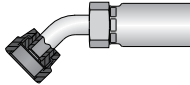
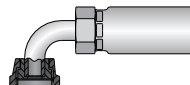
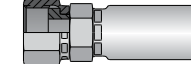
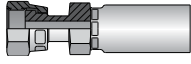

58H Series Visual Index

58H Series PERMANENT	101 Male Taper Pipe Rigid	106 SAE (JIC) 37° Swivel	137 Female JIC 37° Swivel 45° Elbow	139 Female JIC 37° Swivel 90° Elbow Sht	1J1 Seal-Lok™ 90° Elbow Long
					
	E-62	E-62	E-62	E-63	E-64
	1J7 Seal-Lok™ 45° Elbow	1J9 Seal-Lok™ 90° Elbow	1JC Seal-Lok™ Straight Short	1JS Seal-Lok™ Straight	
					
	E-64	E-64	E-63	E-63	

A
Hose

B
Tubing

C
Coiled Air Hose & Fittings

D
Transportation

E
Fittings Series 58H

F
Tooling, Equipment & Accessories

G
General Technical

For detailed ordering information, please consult price list or contact Parflex® Division.

Parker Hannifin Corporation | Parflex® Division | Ravenna, Ohio | parker.com/pfd

www.comoso.com



A Hose

10158H Male Taper Pipe Rigid

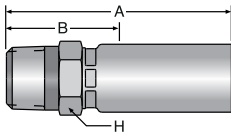

Part Number	NPTF Thread	Hose I.D.		A		Cutoff Allow. B		H Hex
		inch	mm	inch	mm	inch	mm	inch
#								
10158H-12-12	3/4-14	3/4	19	3.91	99	1-11/16	43	1-1/4
10158H-16-16	1-11-1/2	1	1	4.76	121	1-13/16	46	1-3/4

Construction: Steel.
Add "C" for Stainless Steel.

B Tubing

C Coiled Air Hose & Fittings

10658H (JIC) 37° Swivel

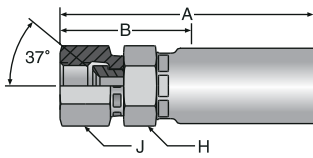

Part Number	Thread Size	Hose I.D.		A		Cutoff Allow. B		H Hex	J Hex
		inch	mm	inch	mm	inch	mm	inch	inch
#									
10658H-12-12	1-1/16-12	3/4	19	4.14	105	1-13/16	46	1-1/4	1-5/16
10658H-16-16	1-5/16-12	1	25	4.89	124	1-15/16	49	1-3/4	1-5/8

Construction: Steel.
Add "C" for Stainless Steel.

D Transportation

E Fittings Series 58H

13758H Female JIC 37° Swivel 45° Elbow

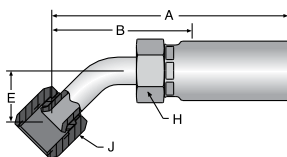

Part Number	Thread Size	Hose I.D.		A		Cutoff Allow. B		E		H Hex	J Hex
		inch	mm	inch	mm	inch	mm	inch	mm	inch	inch
#											
13758H-16-16	1-5/16-12	1	25	5.46	139	2-1/2	64	0.90	23	1-3/4	1-1/2

Construction: Steel.
Add "C" for Stainless Steel.

F Tooling, Equipment & Accessories

G General Technical



13958H Female JIC 37° Swivel 90° Elbow Short Drop

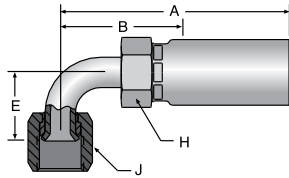

Part Number	Thread Size	Hose I.D.		A		Cutoff Allow. B		E		H Hex	J Hex
		inch	mm	inch	mm	inch	mm	inch	mm	inch	inch
#											
13958H-12-12	1-1/16-12	3/4	19	4.57	116	2-3/8	60	1.81	46	1-1/4	1-1/4
13958H-16-16	1-5/16-12	1	25	5.42	138	2-1/2	64	2.14	54	1-3/4	1-1/2

Construction: Steel.
Add "C" for Stainless Steel.

1JS58H Seal-Lok™ Straight - Long ISO 12151-1-SWSB

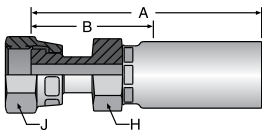

Part Number	Thread Size	Hose I.D.		A		Cutoff Allow. B		H Hex	J Hex
		inch	mm	inch	mm	inch	mm	inch	inch
#									
1JS58H-12-12	1-3/16-12	3/4	19	4.29	109	2-1/16	52	1-1/4	1-3/8
1JS58H-16-16	1-7/16-12	1	25	4.97	126	1-15/16	49	1-3/4	1-5/8

Construction: Steel.
Add "C" for Stainless Steel.

1JC58H Seal-Lok™ Straight-Short ISO 12151-1-SWSA

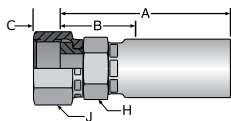

Part Number	Thread Size	Hose I.D.		A		Cutoff Allow. B		C		H Hex	J Hex
		inch	mm	inch	mm	inch	mm	inch	mm	inch	inch
#											
1JC58H-12-12	1-3/16-12	3/4	19	3.86	98	1-1/2	38	.57	14	1-1/4	1-3/8
1JC58H-16-16	1-7/16-12	1	25	4.66	119	1-11/16	43	.58	15	1-3/4	1-5/8

Construction: Steel.
Add "C" for Stainless Steel.

NOTE: When measuring overall length to the end of the nut, B+C dimensions must be used to calculate cut-off allowance. Stainless steel fittings must be assembled with Karrykrimp2 or Parkimp2. See CrimpSource for more information.

A Hose
 B Tubing
 C Coiled Air Hose & Fittings
 D Transportation
 E Fittings Series 58H
 F Tooling, Equipment & Accessories
 G General Technical

A
Hose**1J158H Seal-Lok™ 90° Elbow - Long Drop**

ISO 12151-1-SWEL90

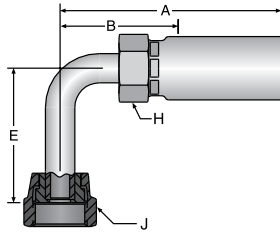

Part Number	Thread Size	Hose I.D.		A		Cutoff Allow. B		E		H Hex	J Hex
		inch	mm	inch	mm	inch	mm	inch	mm	inch	inch
#											
1J158H-12-12	1-3/16-12	3/4	19	4.38	111	1-7/8	48	3.78	96	1-1/4	1-3/8
1J158H-16-16	1-7/16-12	1	25	5.35	136	1-7/8	48	4.50	114	1-3/4	1-5/8

Construction: Steel.

Add "C" for Stainless Steel.

B
TubingC
Coiled Air Hose
& Fittings**1J758H Seal-Lok™ 45° Elbow**

ISO 12151-1-SWE45

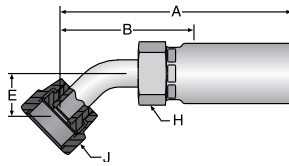

Part Number	Thread Size	Hose I.D.		A		Cutoff Allow. B		E		H Hex	J Hex
		inch	mm	inch	mm	inch	mm	inch	mm	inch	inch
#											
1J758H-12-12	1-3/16-12	3/4	19	4.51	115	2-5/16	59	0.81	21	1-1/4	1-3/8
1J758H-16-16	1-7/16-12	1	25	5.75	146	2-13/16	71	0.94	24	1-3/4	1-5/8

Construction: Steel.

Add "C" for Stainless Steel.

D
TransportationE
Fittings
Series 58H**1J958H Seal-Lok™ 90° Elbow - Short Drop**

ISO 12151-1-SWE90

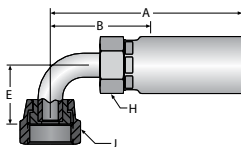



Part Number	Thread Size	Hose I.D.		A		Cutoff Allow. B		E		H Hex	J Hex
		inch	mm	inch	mm	inch	mm	inch	mm	inch	inch
#											
1J958H-12-12	1-3/16-12	3/4	19	4.40	112	2-3/16	56	1.85	47	1-1/4	1-3/8
1J958H-16-16	1-7/16-12	1	25	5.70	145	2-3/4	70	2.21	56	1-3/4	1-5/8



Construction: Steel.

Add "C" for Stainless Steel.

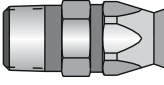
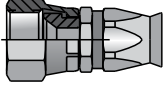
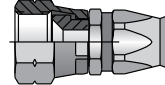
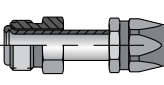
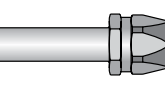
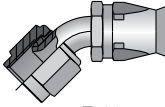
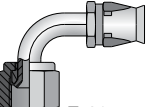
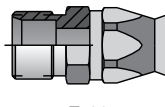
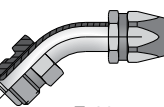
F
Tooling, Equipment
& AccessoriesG
General Technical

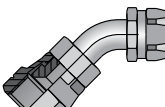
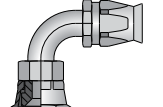
90 Series Visual Index

90 Series FIELD ATTACHABLE	201 Male Taper Pipe Rigid  E-66	206 SAE (JIC) 37° Swivel  E-66	208 SAE 45° Swivel  E-67	228 SAE Male Inverted Swivel Straight  E-67	234 Straight Tube  E-67	
	237 JIC 37° Swivel 45° Elbow  E-68	239 JIC 37° Swivel 90° Elbow Short  E-68	261 SAE Compression Air Brake  E-69	267 SAE Male Inverted Swivel 45° Elbow  E-69	269 SAE Male Inverted Swivel 90° Elbow  E-70	
	277 SAE 45° Swivel 45° Elbow  E-70	279 SAE 45° Swivel 90° Elbow  E-70				

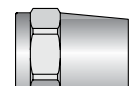
90 Series REPLACEMENT COMPONENTS	200 Replacement Socket  E-71	090 Replacement Ferrule  E-71	60HAB SAE Compression Airbrake Sleeve  E-71	61HAB SAE Compression Airbrake Nut  E-71
--	--	---	---	--

For detailed ordering information, please consult price list or contact Parflex® Division.



A Hose
 B Tubing
 C Coiled Air Hose & Fittings
 D Transportation
 E Fittings Series 90
 F Tooling, Equipment & Accessories
 G General Technical

A Hose

20190 Male Taper Pipe Rigid

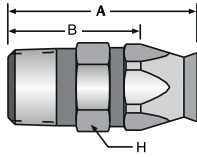

Part Number	Thread Size	Hose Size	A		Cutoff Allow. B		H Hex
			inch	mm	inch	mm	inch
#							
20190-2-4	1/8-27	-4	1.33	34	7/8	22	9/16
20190-4-4	1/4-18	-4	1.58	40	1-1/16	27	9/16
20190-4-5	1/4-18	-5	1.66	42	1-1/8	29	5/8
20190-4-6	1/4-18	-6	1.66	42	1-1/8	29	11/16
20190-6-6	3/8-18	-6	1.66	42	1-1/8	29	11/16
20190-6-8	3/8-18	-8	1.77	45	1-3/16	30	7/8
20190-8-8	1/2-14	-8	1.97	50	1-7/16	37	7/8
20190-8-10	1/2-14	-10	2.13	54	1-7/16	37	1
20190-12-12	3/4-14	-12	2.26	57	1-9/16	40	1-1/8
20190-12-16	3/4-14	-16	2.29	58	1-5/8	41	1-3/8
20190-16-16	1-11-1/2	-16	2.46	62	1-7/8	48	1-3/8
20190-20-20	1-1/4-11-1/2	-20	2.69	68	2-1/16	52	2

Construction: Brass nipple and ferrule, steel socket.

Add "C" for Stainless Steel.

B Tubing

C Coiled Air Hose & Fittings

D Transportation

20690 SAE (JIC) 37° Swivel

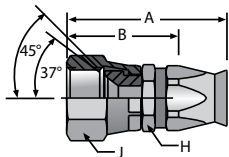

Part Number	Thread Size	Hose Size	A		Cutoff Allow. B		H Hex	J Hex
			inch	mm	inch	mm	inch	inch
#								
20690-4-4	7/16-20	-4	1.58	40	1-1/8	29	9/16	9/16
20690-5-5	1/2-20	-5	1.66	42	1-1/8	29	5/8	5/8
20690-6-6	9/16-18	-6	1.74	44	1-3/16	35	11/16	11/16
20690-8-6	3/4-16	-6	1.85	47	1-5/16	33	7/8	7/8
20690-8-8	3/4-16	-8	1.98	50	1-3/8	35	7/8	7/8
20690-8-10	3/4-16	-10	2.07	53	1-7/16	37	1	7/8
20690-10-10	7/8-14	-10	2.22	56	1-1/2	38	1	1
20690-12-12	1-1/16-12	-12	2.33	59	1-5/8	41	1-1/4	1-1/4
20690-16-16	1-5/16-12	-16	2.52	64	1-15/16	49	1-3/8	1-1/2
20690-20-20	1-5/8-12	-20	2.99	76	2-5/16	59	2	2

Construction: Brass nipple and ferrule, steel nut and socket.

Add "C" for Stainless Steel.

NOTE: Sizes -4, -5, -8 and -10 incorporate a dual seat.

E Fittings Series 90

F Tooling, Equipment & Accessories

G General Technical



20890 SAE 45° Swivel

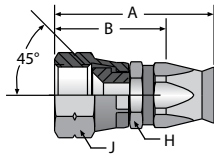

Part Number	Thread Size	Hose Size	A		Cutoff Allow. B		H Hex	J Hex
			inch	mm	inch	mm	inch	inch
#								
20890-6-6	5/8-18	-6	1.77	45	1-1/4	32	11/16	3/4
20890-12-12	1-1/16-14	-12	2.34	59	1-11/16	43	1-1/8	1-1/4

Construction: Brass nipple and ferrule, steel nut and socket.

Add "C" for Stainless Steel.

22890 SAE Male Inverted Swivel-Straight

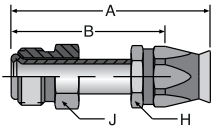

Part Number	Thread Size	Hose Size	A		Cutoff Allow. B		H Hex	J Hex
			inch	mm	inch	mm	inch	inch
#								
22890-4-4	7/16-24	-4	2.15	55	1-11/16	43	9/16	7/16
22890-5-5	1/2-20	-5	2.21	56	1-11/16	43	5/8	1/2
22890-5-6	1/2-20	-6	2.20	56	1-11/16	43	11/16	1/2
22890-6-6	5/8-18	-6	2.22	56	1-11/16	43	11/16	5/8
22890-8-8	3/4-18	-8	2.34	59	1-13/16	46	13/16	3/4
22890-10-10	7/8-18	-10	2.53	64	1-7/8	48	15/16	7/8
22890-12-12	1-1/16-16	-12	3.01	76	2-3/8	60	1-1/8	1-1/16

Construction: Brass ferrule, steel tube, nut and socket.

Add "C" for Stainless Steel.

23490 Straight Tube

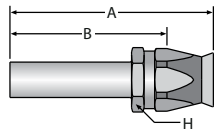

Part Number	Hose Size	Tube Size		A		Cutoff Allow. B		H Hex
		inch	mm	inch	mm	inch	mm	inch
#								
23490-8-8	-8	1/2	6	3.06	78	2-1/2	64	13/16
23490-8-10	-10	1/2	8	3.15	80	2-1/2	64	1
23490-10-8	-8	5/8	8	3.26	83	2-5/8	67	13/16
23490-10-10	-10	5/8	10	3.28	83	2-5/8	67	1
23490-12-12	-12	3/4	13	3.28	83	2-11/16	68	1-1/8

Construction: Brass nipple and ferrule, steel socket.

Add "C" for Stainless Steel.

NOTE: 26T90 fitting includes 23490 with the 60HAB sleeve and 61HAB nut.

For detailed ordering information, please consult price list or contact Parflex® Division.

Parker Hannifin Corporation | Parflex® Division | Ravenna, Ohio | parker.com/pfd

www.comoso.com



A Hose

B Tubing

C Coiled Air Hose & Fittings

D Transportation

E Fittings Series 90

F Tooling, Equipment & Accessories

G General Technical

A Hose

23790 JIC 37° Swivel 45° Elbow

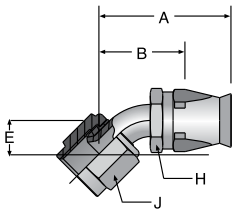

Part Number	Thread Size	Hose Size	A		Cutoff Allow. B		E		H Hex	J Hex
			inch	mm	inch	mm	inch	mm	inch	inch
#										
23790-4-4	7/16-20	-4	1.79	45	1-3/8	35	0.33	8	9/16	9/16
23790-5-5	1/2-20	-5	1.86	47	1-3/8	35	0.36	9	5/8	5/8
23790-6-6	9/16-18	-6	1.96	50	1-7/16	37	0.39	10	11/16	11/16
23790-8-6	3/4-16	-6	2.11	54	1-11/16	43	0.55	14	11/16	7/8
23790-8-8	3/4-16	-8	2.40	61	1-3/4	44	0.55	14	13/16	7/8
23790-10-10	7/8-14	-10	2.45	62	1-7/8	48	0.63	16	15/16	1
23790-12-12	1-1/16-12	-12	3.04	77	2-7/16	62	0.78	20	1-1/8	1-1/4
23790-16-16	1-5/16-12	-16	3.28	83	2-11/16	68	0.90	23	1-3/8	1-1/2
23790-20-20	1-5/8-12	-20	3.70	94	3-1/16	78	1.18	30	1-3/4	2

Construction: Brass ferrule, steel tube, nut and socket.

Add "C" for Stainless Steel.

B Tubing

C Coiled Air Hose & Fittings

D Transportation

23990 JIC 37° Swivel 90° Elbow Short Drop

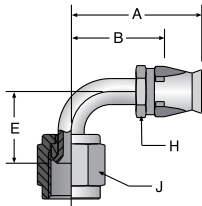

Part Number	Thread Size	Hose Size	A		Cutoff Allow. B		E		H Hex	J Hex
			inch	mm	inch	mm	inch	mm	inch	inch
#										
23990-4-4	7/16-20	-4	1.67	41	1-1/4	32	0.68	17	9/16	9/16
23990-5-5	1/2-20	-5	1.75	44	1-1/4	32	0.77	20	5/8	5/8
23990-6-6	9/16-18	-6	1.86	47	1-3/8	35	0.85	22	11/16	11/16
23990-8-6	3/4-16	-6	1.95	50	1-7/16	37	1.09	28	11/16	7/8
23990-8-8	3/4-16	-8	2.15	55	1-1/2	38	1.09	28	13/16	7/8
23990-10-10	7/8-14	-10	2.38	60	1-3/4	44	1.23	31	15/16	1
23990-12-12	1-1/16-12	-12	2.95	75	2-5/16	59	1.82	46	1-1/8	1-1/4
23990-16-16	1-5/16-12	-16	3.13	80	2-1/2	64	2.14	54	1-3/8	1-1/2
23990-20-20	1-5/8-12	-20	3.54	90	2-7/8	73	2.57	65	1-3/4	2

Construction: Brass ferrule, steel tube, nut and socket.

Add "C" for Stainless Steel.

E Fittings Series 90

F Tooling, Equipment & Accessories

G General Technical



26190 SAE Compression Air Brake

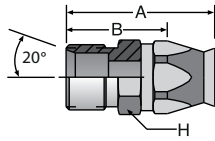

Part Number	Thread Size	Hose Size	A		Cutoff Allow. B		H Hex
			inch	mm	inch	mm	inch
#							
26190-8-8	11/16-20	-8	1.69	43	1-1/16	27	13/16
26190-8-10	11/16-20	-10	1.86	47	1-3/16	30	1
26190-10-10	13/16-18	-10	1.92	49	1-1/4	32	1
26190-12-10	1-18	-10	2.09	53	1-7/16	37	1
26190-12-12	1-18	-12	2.09	53	1-7/16	37	1-1/8

Construction: Brass nipple and ferrule, steel socket.

Add "B" for Brass nipple and socket.

Add "C" for Stainless Steel.

26790 SAE Male Inverted Swivel 45° Elbow

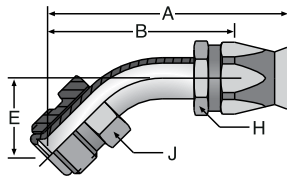

Part Number	Thread Size	Hose Size	A		Cutoff Allow. B		E		H Hex	J Hex
			inch	mm	inch	mm	inch	mm	inch	inch
#										
26790-4-4	7/16-24	-4	2.11	54	1-11/16	43	0.63	16	9/16	7/16
26790-5-5	1/2-20	-5	2.51	64	2	51	0.94	24	5/8	1/2
26790-5-6	1/2-20	-6	2.55	65	2-1/16	52	0.94	24	11/16	1/2
26790-6-6	5/8-18	-6	2.61	66	2-1/8	54	0.94	24	11/16	5/8
26790-8-8	3/4-18	-8	2.97	75	2-3/8	60	0.94	24	13/16	3/4
26790-8-10	3/4-18	-10	3.05	77	2-7/16	62	0.94	24	15/16	3/4
26790-10-10	7/8-18	-10	3.43	87	2-11/16	68	1.02	26	15/16	7/8
26790-12-12	1-1/16-16	-12	3.83	97	3-3/16	81	1.15	29	1-1/8	1-1/16

Construction: Brass ferrule, steel tube, nut and socket.

Add "C" for Stainless Steel.

For detailed ordering information, please consult price list or contact Parflex® Division.

Parker Hannifin Corporation | Parflex® Division | Ravenna, Ohio | parker.com/pfd

www.comoso.com



A Hose
 B Tubing
 C Coiled Air Hose & Fittings
 D Transportation
 E Fittings Series 90
 F Tooling, Equipment & Accessories
 G General Technical

A Hose

26990 SAE Male Inverted Swivel 90° Elbow

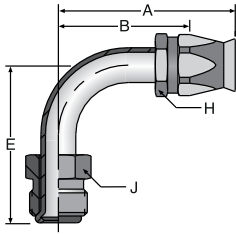

Part Number	Thread Size	Hose Size	A		Cutoff Allow. B		E		H Hex	J Hex
			inch	mm	inch	mm	inch	mm	inch	inch
#										
26990-4-4	7/16-24	-4	1.79	45	1-5/16	33	1.19	30	9/16	7/16
26990-5-5	1/2-20	-5	2.01	51	1-1/2	38	1.65	42	5/8	1/2
26990-5-6	1/2-20	-6	2.05	52	1-9/16	40	1.65	42	11/16	1/2
26990-6-6	5/8-18	-6	2.03	52	1-1/2	38	1.70	43	11/16	5/8
26990-8-8	3/4-18	-8	2.30	58	1-11/16	43	1.78	45	13/16	3/4
26990-8-10	3/4-18	-10	2.39	61	1-3/4	44	1.78	45	15/16	3/4
26990-10-10	7/8-18	-10	3.16	80	2-1/2	64	2.18	55	15/16	7/8
26990-12-12	1-1/16-16	-12	3.56	90	2-15/16	75	2.51	64	1-1/8	1-1/16

Construction: Brass ferrule, steel tube, nut and socket.

Add "C" for Stainless Steel.

B Tubing

C Coiled Air Hose & Fittings

27790 SAE 45° Swivel 45° Elbow

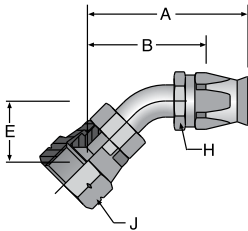

Part Number	Thread Size	Hose Size	A		Cutoff Allow. B		E		H Hex	J Hex
			inch	mm	inch	mm	inch	mm	inch	inch
#										
27790-6-6	5/8-18	-6	1.72	44	1-3/16	30	0.39	10	11/16	3/4
27790-12-12	1-1/16-14	-12	3.03	77	2-3/8	60	0.78	20	1-1/8	1-1/4

Construction: Brass ferrule, steel tube, nut and socket.

Add "C" for Stainless Steel.

D Transportation

E Fittings Series 90

27990 SAE 45° Swivel 90° Elbow

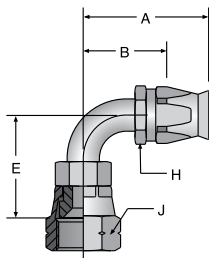

Part Number	Thread Size	Hose Size	A		Cutoff Allow. B		E		H Hex	J Hex
			inch	mm	inch	mm	inch	mm	inch	inch
#										
27990-4-4	7/16-20	-4	1.67	42	1-1/4	32	.68	17	9/16	9/16
27990-5-5	1/2-20	-5	1.75	44	1-1/4	32	.77	20	5/8	5/8
27990-6-6	5/8-18	-6	1.86	47	1-3/8	35	.85	22	11/16	3/4
27990-8-8	3/4-16	-8	2.09	53	1-1/2	38	1.09	28	13/16	7/8
27990-12-12	1-1/16-14	-12	2.95	75	2-5/16	39	1.82	46	1-1/8	1-1/4

Construction: Brass ferrule, steel tube, nut and socket.

Add "C" for Stainless Steel.

F Tooling, Equipment & Accessories

G General Technical



20090 Replacement Socket for Field Attachable Fittings

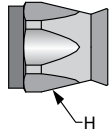

Part Number	H Hex
#	
	inch
20090-4	9/16
20090-5	5/8
20090-6	11/16
20090-8	7/8
20090-10	1
20090-12	1-1/8
20090-16	1-3/8
20090-20	1-3/4

Construction: Steel or Stainless Steel.
Add "C" for Stainless Steel.

60 HAB SAE Compression Airbrake Sleeve

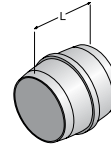

Part Number	Tube Size		L
	inch	mm	
#			
60HAB-4	1/4	6	.250
60HAB-6	3/8	10	.313
60HAB-8	1/2	13	.375
60HAB-10	5/8	16	.438
60HAB-12	3/4	19	.500

Construction: Brass.
NOTE: To be used with 13491N & 23490.

090 Replacement Ferrule for 90 Series Field Attachable Fittings

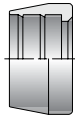

Part Number	Hose Size
#	
090-4B	-4
090-5B	-5
090-6B	-6
090-8B	-8
090-10B	-10
090-12B	-12
090-16B	-16
090-20B	-20

Construction: Brass.
Replace "B" with "C" for Stainless Steel.

61 HAB SAE Compression Airbrake Nut

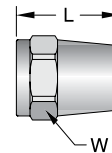

Part Number	Thread Size	Tube Size		L		W Hex
		inch	mm	inch	mm	
#						
61HAB-4	7/16-24	1/4	6	0.75	19	9/16
61HAB-6	7/32-24	3/8	10	1.13	29	5/8
61HAB-8	11/16-20	1/2	13	1.25	32	13/16
61HAB-10	13/16-18	5/8	16	1.38	35	15/16
61HAB-12	1-18	3/4	19	1.56	40	1-1/8

Construction: Brass.
NOTE: To be used with 13491N & 23490 Fittings.

For detailed ordering information, please consult price list or contact Parflex® Division.

Parker Hannifin Corporation | Parflex® Division | Ravenna, Ohio | parker.com/pfd

www.comoso.com



A Hose
 B Tubing
 C Coiled Air Hose & Fittings
 D Transportation
 E Fittings Series 90
 F Tooling, Equipment & Accessories
 G General Technical

A
Hose

91N/91 Series Visual Index

B
Tubing

C
Coiled Air Hose & Fittings

D
Transportation

E
Fittings Series 91

F
Tooling, Equipment & Accessories

G
General Technical

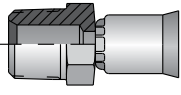
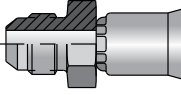
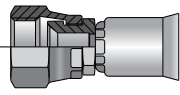
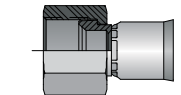
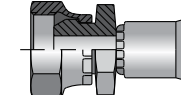
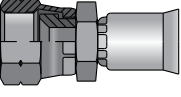
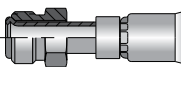
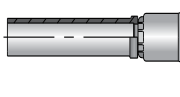
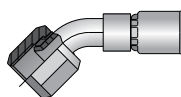
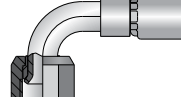
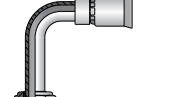
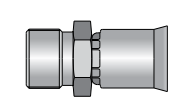
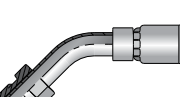
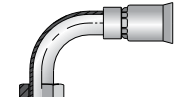
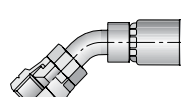
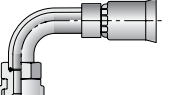
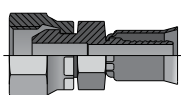
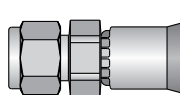
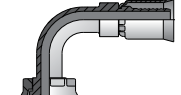
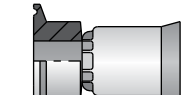
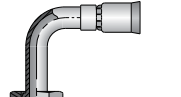
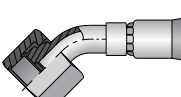
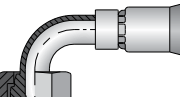
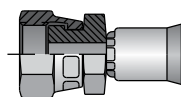
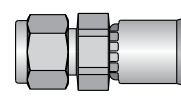
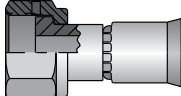
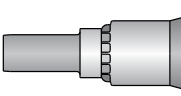
91N/91 Series PERMANENT	101 Male Taper Pipe Rigid  E-73	103 Male JIC 37°  E-73	106 JIC 37° Female Swivel  E-74	106 RD JIC 37° Female Swivel w/o Nip. Hex  E-74	107 Female Pipe Swivel  E-75
	108 Female SAE 45° Swivel  E-75	128 Male Inverted Swivel Straight  E-75	134 Straight Tube  E-76	137 Female JIC 37° Swivel 45° Elbow  E-76	139 Female JIC 37° Swivel 90° Elbow Sht.  E-77
141 Female JIC 37° Swivel 90° Elb Long  E-77	161 Compression Air Brake  E-78	167 SAE Male Inverted 45° Elbow  E-78	169 SAE Male Inverted 90° Elbow  E-79	177 SAE 45° Swivel 45° Elbow  E-79	
179 Female SAE 45° Swivel 90° Elbow  E-79	192 Female BSP Pipe Swivel - Str. (60° Cone)  E-84	1AL A-Lok® Compression  E-80	1B2 Female BSP Pipe Swivel 90° Elb. (60° Cone)  E-84	1FN Sanitary Flange  E-80	
1J1 Female Seal-Lok™ 90° Elbow Long  E-81	1J7 Female Seal-Lok™ 45° Elbow  E-81	1J9 Female Seal-Lok™ 90° Elbow Short  E-82	1JC Female Seal-Lok™ Swivel Straight Short  E-82	1P6 CPI® Compression w/nut and ferrule  E-80	
1Q1 Female Ultra Seal  E-83	1TU Universal Tube Stub  E-83				



10191N Male Taper Pipe Rigid

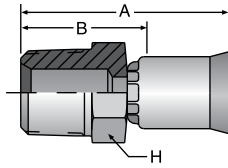

Part Number	Thread Size	Hose Size	A		Cutoff Allow. B		H Hex
			inch	mm	inch	mm	inch
#							
10191N-2-4	1/8-27	-4	1.27	32	3/4	19	7/16
10191N-4-4	1/4-18	-4	1.50	38	15/16	24	9/16
10191N-4-5	1/4-18	-5	1.55	39	15/16	24	9/16
10191N-4-6	1/4-18	-6	1.60	41	15/16	24	9/16
10191N-6-6	3/8-18	-6	1.65	58	1	25	11/16
10191N-6-8	3/8-18	-8	1.71	43	1	25	11/16
10191N-8-8	1/2-14	-8	1.94	49	1-1/4	32	7/8
10191N-8-10	1/2-14	-10	1.96	50	1-1/4	32	7/8
10191N-8-12	1/2-14	-12	2.42	61	1-1/4	32	1
10191N-12-12	3/4-14	-12	2.19	56	1-3/8	35	1-1/8
10191N-16-16	1-11-1/2	-16	2.46	62	1-1/2	38	1-3/8
10191-20-20	1-1/4-11-1/2	-20	3.05	77	2-1/16	52	1-3/4

Construction: Brass nipple, steel shell.

Add "B" for Brass nipple and shell.

Add "C" for Stainless Steel.

10391N Male (JIC) 37°

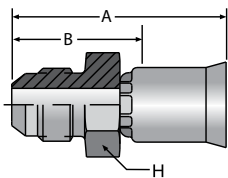

Part Number	Thread Size	Hose Size	A		Cutoff Allow. B		H Hex
			inch	mm	inch	mm	inch
#							
10391N-4-4	7/16-20	-4	1.37	35	13/16	21	1/2
10391N-5-5	1/2-20	-5	1.48	38	7/8	22	9/16
10391N-6-6	9/16-18	-6	1.64	42	1	25	11/16
10391N-8-8	3/4-16	-8	1.79	35	1-1/8	29	7/8
10391N-8-6	3/4-16	-6	1.73	44	1-1/16	27	7/8
10391N-10-10	7/8-14	-10	2.07	53	1-3/8	35	1
10391N-12-12	1-1/16-12	-12	2.10	53	1-5/16	33	1-1/8
10391N-16-16	1-5/16-12	-16	2.43	62	1-1/2	38	1-3/8

Construction: Brass nipple, steel shell.

Add "B" for Brass nipple and shell.

Add "C" for Stainless Steel.

For detailed ordering information, please consult price list or contact Parflex® Division.

Parker Hannifin Corporation | Parflex® Division | Ravenna, Ohio | parker.com/pfd

www.comoso.com



E-73

A
Hose

B
Tubing

C
Coiled Air Hose
& Fittings

D
Transportation

E
Fittings
Series 91

F
Tooling, Equipment
& Accessories

G
General Technical

A Hose

10691N SAE (JIC) 37° Swivel

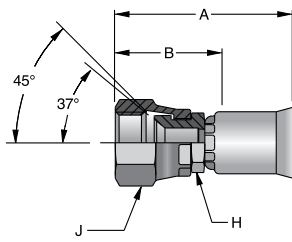

Part Number	Thread Size	Hose Size	A		Cutoff Allow. B		H Hex	J Hex
			inch	mm	inch	mm	inch	inch
#								
10691N-4-4	7/16-20	-4	1.43	36	7/8	22	3/8	9/16
10691N-5-5	1/2-20	-5	1.56	40	15/16	24	7/16	5/8
10691N-6-6	9/16-18	-6	1.63	41	1	25	1/2	11/16
10691N-6-8	9/16-18	-8	1.69	43	1	25	9/16	11/16
10691N-8-8	3/4-16	-8	1.89	48	1-3/16	30	11/16	7/8
10691N-8-10	3/4-16	-10	1.86	58	1-1/8	29	3/4	7/8
10691N-10-10	7/8-14	-10	2.03	52	1-5/16	33	13/16	1
10691N-12-12	1-1/16-12	-12	2.12	54	1-5/16	33	1	1-1/4
10691N-16-16	1-5/16-12	-16	2.45	62	1-9/16	40	1-1/4	1-1/2
10691-20-20	1-5/8-12	-20	2.98	76	1-13/16	46	1-11/16	2

Construction: Brass nipple, steel nut and shell.
 Add "B" for Brass nipple, nut and shell.
 Add "S" for Steel nipple, nut and shell.
 Add "C" for Stainless Steel.
 NOTE: Sizes -4, -5, -8 and -10 incorporate a dual seat.

B Tubing

C Coiled Air Hose & Fittings

D Transportation

10691NRD SAE (JIC) 37° Swivel

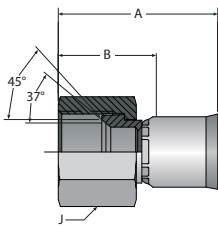

Part Number	Thread Size	Hose Size	A		Cutoff Allow. B		J Hex
			inch	mm	inch	mm	inch
#							
10691N-4-4-RD	7/16-20	-4	1.34	34	13/16	21	9/16
10691N-5-5-RD	1/2-20	-5	1.51	38	7/8	22	5/8
10691N-6-6-RD	9/16-18	-6	1.60	41	15/16	24	11/16
10691N-8-8-RD	3/4-16	-8	1.79	45	1-1/16	27	7/8
10691N-10-10-RD	7/8-14	-10	1.91	49	1-3/16	30	1
10691N-12-12-RD	1-1/16-12	-12	2.09	58	1-5/16	33	1-1/4
10691N-16-16-RD	1-5/16-12	-16	2.27	58	1-5/16	33	1-1/2

Construction: Brass nipple, steel nut and shell.
 Add "B" for Brass nipple, nut and shell.
 Add "C" for Stainless Steel.
 NOTE: Sizes -4, -5, -8 and -10 incorporate a dual seat.

E Fittings Series 91

F Tooling, Equipment & Accessories

G General Technical



10791N Female Pipe Swivel

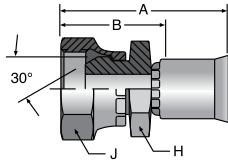

Part Number	Thread Size	Hose Size	A		Cutoff Allow. B		H Hex	J Hex
			inch	mm	inch	mm	inch	inch
#								
10791N-4-4	1/4-18	-4	1.50	38	15/16	24	9/16	11/16
10791N-6-6	3/8-18	-6	1.67	42	1	25	5/8	7/8
10791N-8-8	1/2-14	-8	1.83	46	1-1/8	29	3/4	1
10791N-12-12	3/4-14	-12	2.09	53	1-5/16	33	1	1-1/4
10791N-16-16	1-11-1/2	-16	2.26	57	1-5/16	33	1-3/16	1-3/8

Construction: Brass nipple, steel nut and shell.

Add "B" for Brass nipple, nut and shell.

Add "C" for Stainless Steel.

10891N SAE 45° Swivel

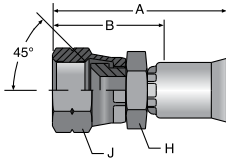

Part Number	Thread Size	Hose Size	A		Cutoff Allow. B		H Hex	J Hex
			inch	mm	inch	mm	inch	inch
#								
10891N-6-6	5/8-18	-6	1.69	43	1-1/16	27	5/8	3/4
10891N-12-12	1-1/16-14	-12	2.12	54	1-5/16	33	1	1-1/4

Construction: Brass nipple, steel nut and shell.

Add "S" for Steel nipple, nut and shell.

Add "C" for Stainless Steel.

12891N Male Inverted Swivel–Straight

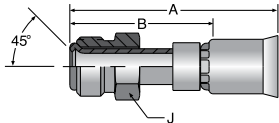

Part Number	Thread Size	Hose Size	A		Cutoff Allow. B		J Hex
			inch	mm	inch	mm	inch
#							
12891N-4-4	7/16-24	-4	2.09	53	1-1/2	38	7/16
12891N-5-5	1/2-20	-5	2.15	55	1-9/16	40	1/2
12891N-5-6	1/2-20	-6	2.23	57	1-9/16	40	1/2
12891N-6-6	5/8-18	-6	2.23	57	1-9/16	40	5/8
12891N-8-8	3/4-18	-8	2.31	59	1-5/8	41	3/4
12891N-10-10	7/8-18	-10	2.43	58	1-3/4	44	7/8
12891N-12-12	1-1/16-16	-12	2.50	64	1-11/16	43	1-1/16

Construction: Steel nipple, tube, nut and shell.

Add "C" for Stainless Steel.

For detailed ordering information, please consult price list or contact Parflex® Division.

Parker Hannifin Corporation | Parflex® Division | Ravenna, Ohio | parker.com/pfd

www.comoso.com



A Hose

B Tubing

C Coiled Air Hose & Fittings

D Transportation

E Fittings Series 91

F Tooling, Equipment & Accessories

G General Technical

A Hose

13491N Straight Tube

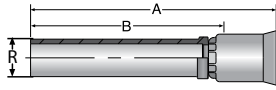

Part Number	Hose Size	Diameter R	A		Cutoff Allow. B	
			inch	mm	inch	mm
#						
13491N-8-8	-8	1/2	2.80	71	2-1/8	54
13491N-8-10	-10	1/2	2.81	71	2-1/8	54
13491N-10-10	-10	5/8	2.96	75	2-1/4	58
13491N-12-12	-12	3/4	3.37	86	2-9/16	65

Construction: Brass nipple, steel shell.
 Add "B" for Brass nipple and shell.
 Add "C" for Stainless Steel.
 NOTE: The 16T91N fitting includes 13491N with the 60HAB sleeve and 61HAB nut.

B Tubing

C Coiled Air Hose & Fittings

13791N JIC 37° Swivel 45° Elbow

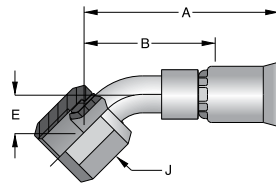

Part Number	Thread Size	Hose Size	A		Cutoff Allow. B		E		J Hex
			inch	mm	inch	mm	inch	mm	inch
#									
13791N-4-4	7/16-20	-4	1.74	44	1-3/16	30	0.33	8	9/16
13791N-5-5	1/2-20	-5	1.87	47	1-1/4	32	0.36	9	5/8
13791N-6-6	9/16-18	-6	1.94	49	1-5/16	33	0.43	11	11/16
13791N-8-8	3/4-16	-8	2.28	58	1-9/16	37	0.55	14	7/8
13791N-10-10	7/8-14	-10	2.42	61	1-11/16	43	0.64	43	1
13791N-12-12	1-1/16-12	-12	2.83	58	2-1/16	52	0.78	20	1-1/4
13791N-16-16	1-5/16-12	-16	3.18	81	2-1/4	57	0.89	23	1-1/2
13791-20-20	1-5/8-12	-20	3.67	93	2-9/16	65	1.10	28	2

Construction: Steel tube, nipple, nut and shell.
 Add "C" for Stainless Steel.

D Transportation

E Fittings Series 91

F Tooling, Equipment & Accessories

G General Technical

Non Standard. See page ii for information on non-standard products.



13991N JIC 37° Swivel 90° Elbow Short Drop

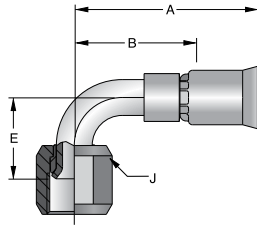

Part Number	Thread Size	Hose Size	A		Cutoff Allow. B		E		J Hex
			inch	mm	inch	mm	inch	mm	inch
#									
13991N-4-4	7/16-20	-4	1.62	41	1-1/16	37	0.68	17	9/16
13991N-5-5	1/2-20	-5	1.71	43	1-1/8	29	0.77	20	5/8
13991N-6-6	9/16-18	-6	1.91	49	1-1/4	32	0.91	23	11/16
13991N-8-8	3/4-16	-8	2.03	52	1-5/16	33	1.09	28	7/8
13991N-10-10	7/8-14	-10	2.27	58	1-9/16	37	1.23	43	1
13991N-12-12	1-1/16-12	-12	2.75	58	1-15/16	49	1.82	46	1-1/2
13991N-16-16	1-5/16-12	-16	3.15	80	2-3/16	56	2.14	52	1-1/2
13991-20-20	1-5/8-12	-20	3.53	90	2-7/16	62	1.18	30	2

Construction: Steel tube, nipple, nut and shell.

Add "C" for Stainless Steel.

14191N JIC 37° Swivel 90° Elbow Long Drop

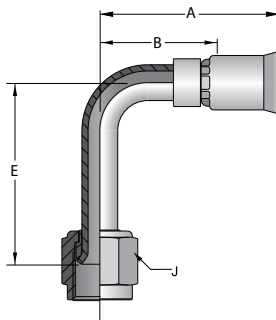

Part Number	Thread Size	Hose Size	A		Cutoff Allow. B		E		J Hex
			inch	mm	inch	mm	inch	mm	inch
#									
14191N-4-4	7/16-20	-4	1.66	42	1-1/8	29	1.80	46	9/16
14191N-5-5	1/2-20	-5	1.72	44	1-1/8	29	1.77	45	5/8
14191N-6-6	9/16-18	-6	1.93	49	1-5/16	33	2.13	54	11/16
14191N-8-8	3/4-16	-8	2.11	54	1-3/8	35	2.43	62	7/8
14191N-10-10	7/8-14	-10	2.34	59	1-5/8	41	2.57	65	1
14191N-12-12	1-1/16-12	-12	2.63	67	1-7/8	48	3.73	95	1-1/4
14191N-16-16	1-5/16-12	-16	3.15	80	2-3/16	56	4.33	110	1-1/2
14191-20-20	1-5/8-12	-20	4.00	102	2-15/16	75	5.28	134	2

Construction: Steel tube, nipple, nut and shell.

Add "C" for Stainless Steel.

For detailed ordering information, please consult price list or contact Parflex® Division.

Parker Hannifin Corporation | Parflex® Division | Ravenna, Ohio | parker.com/pfd

www.comoso.com



A Hose
 B Tubing
 C Coiled Air Hose & Fittings
 D Transportation
 E Fittings Series 91
 F Tooling, Equipment & Accessories
 G General Technical

A
Hose

16191N Compression Air Brake

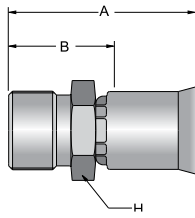

Part Number	Thread Size	Hose Size	A		Cutoff Allow. B		H Hex	
			inch	mm	inch	mm	inch	mm
#								
16191N-8-8	11/16-20	-8	1.61	41	15/16	24		3/4
16191N-8-10	11/16-20	-10	1.61	41	15/16	24		7/8
16191N-10-10	13/16-18	-10	1.82	46	1-1/8	29		15/16
16191N-12-12	1-18	-12	1.93	49	1-1/8	29		1-1/4

Construction: Brass nipple, steel shell.

Add "B" for Brass nipple and shell.

Add "C" for Stainless Steel.

B
Tubing

C
Coiled Air Hose
& Fittings

D
Transportation

16791N Male Inverted Swivel 45° Elbow

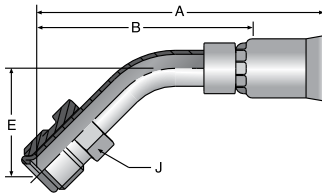

Part Number	Thread Size	Hose Size	A		Cutoff Allow. B		E		J Hex
			inch	mm	inch	mm	inch	mm	inch
#									
16791N-4-4	7/16-24	-4	2.05	52	1-1/2	38	0.63	16	7/16
16791N-5-5	1/2-20	-5	2.48	63	1-7/8	48	0.71	18	1/2
16791N-6-6	5/8-18	-6	2.60	66	1-15/16	49	0.96	24	5/8
16791N-8-8	3/4-18	-8	2.85	72	2-1/8	54	0.90	23	3/4
16791N-10-10	7/8-18	-10	3.30	84	2-5/8	67	1.02	43	7/8
16791N-12-12	1-1/16-16	-12	3.64	58	2-13/16	71	1.15	29	1-1/16

Construction: Steel tube, nipple, nut and shell.

Add "C" for Stainless Steel.

E
Fittings
Series 91

F
Tooling, Equipment
& Accessories

G
General Technical



16991N Male Inverted Swivel 90° Elbow

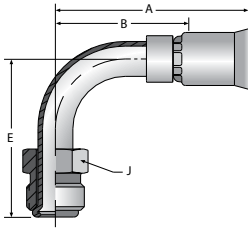

Part Number	Thread Size	Hose Size	A		Cutoff Allow. B		E		J Hex
			inch	mm	inch	mm	inch	mm	inch
#									
16991N-4-4	7/16-24	-4	1.72	44	1-3/16	30	1.19	30	7/16
16991N-5-5	1/2-20	-5	1.98	50	1-3/8	35	1.65	42	1/2
16991N-5-6	1/2-20	-6	2.03	52	1-7/16	37	1.65	42	1/2
16991N-6-6	5/8-18	-6	2.08	53	1-7/16	37	1.70	43	5/8
16991N-8-8	3/4-18	-8	2.18	55	1-1/2	38	1.87	43	3/4
16991N-10-10	7/8-18	-10	3.02	58	2-5/16	59	2.18	55	7/8
16991N-12-12	1-1/16-16	-12	3.36	85	2-9/16	64	2.51	64	1-1/16

Construction: Steel tube, nipple, nut and shell.

Add "C" for Stainless Steel.

17791N SAE 45° Swivel 45° Elbow

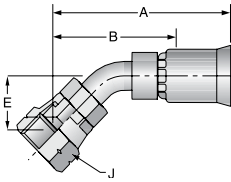

Part Number	Thread Size	Hose Size	A		Cutoff Allow. B		E		J Hex
			inch	mm	inch	mm	inch	mm	inch
#									
17791N-6-6	5/8-18	3/8	2.06	52	1-5/16	33	0.39	10	3/4
17791N-12-12	1-1/16-14	3/4	3.07	78	2-7/16	62	0.78	20	1-1/4

Construction: Steel tube, nipple, nut and shell.

Add "C" for Stainless Steel.

17991N SAE 45° Swivel 90° Elbow

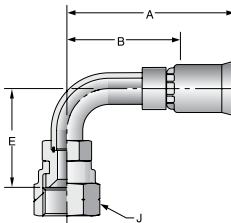

Part Number	Thread Size	Hose Size	A		Cutoff Allow. B		E		J Hex
			inch	mm	inch	mm	inch	mm	inch
#									
17991N-6-6	5/8-18	3/8	2.06	52	1-5/16	49	1.19	30	3/4
17991N-12-12	1-1/16-14	3/4	2.92	74	2-1/8	54	1.82	46	1-1/4

Construction: Steel tube, nipple, nut and shell.

Add "C" for Stainless Steel.

For detailed ordering information, please consult price list or contact Parflex® Division.

Parker Hannifin Corporation | Parflex® Division | Ravenna, Ohio | parker.com/pfd

www.comoso.com



E-79

A
Hose

B
Tubing

C
Coiled Air Hose
& Fittings

D
Transportation

E
Fittings
Series 91

F
Tooling, Equipment
& Accessories

G
General Technical

A Hose

1AL91N A-LOK® Compression

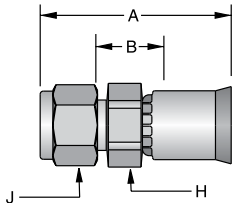

Part Number	Part Number	Hose Size	A		Cutoff Allow. B		H Hex	J Hex
			inch	mm	inch	mm	inch	inch
#	#							
w/nut & ferrule	w/o nut & ferrules							
1AL91N-4-4C	1AL91N-4-4NC	-4	1.30	33	7/16	11	1/2	9/16
1AL91N-4-5C	1AL91N-4-5NC	-5	1.35	34	7/16	11	1/2	9/16
1AL91N-6-6C	1AL91N-6-6NC	-6	1.53	39	1/2	13	5/8	11/16
1AL91N-8-8C	1AL91N-8-8NC	-8	1.61	41	7/16	11	13/16	7/8
1AL91N-12-12C	1AL91N-12-12NC	-12	1.86	47	1/2	13	1-1/8	1-1/8
1AL91N-16-16C	1AL91N-16-16NC	-16	2.11	58	7/16	11	1-3/8	1-1/2

Construction: Stainless steel nipple, nut, ferrules and shell.

NOTE: Nut part No. is **XNUX-316**;
 Front ferrule part No. is **XFFX-316**;
 Back ferrule part No. is **XBFX-316**.
 X denotes dash size.

Nuts and Ferrules are Manufactured by the Instrumentation Products Division. Refer to Catalog 4230/4233 for Installation Instructions and Replacement Components.

B Tubing

C Coiled Air Hose & Fittings

1P691N CPI® Compression (With Nut and Ferrule)

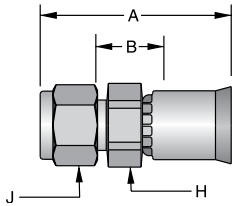

Part Number	Hose Size	A		Cutoff Allow. B		H Hex	J Hex
		inch	mm	inch	mm	inch	inch
#							
w/nut & ferrules							
1P691N-4-4C	-4	1.30	33	7/16	11	1/2	9/16
1P691N-6-6C	-6	1.53	39	1/2	13	5/8	11/16
1P691N-8-8C	-8	1.61	41	7/16	11	13/16	7/8

Construction: Stainless steel nipple and shell.

NOTE: Nut part No. is **XBZ-SS**;
 Ferrule part No. is **XTZ-SS**;
 X denotes dash size.

Nuts and Ferrules are Manufactured by the Instrumentation Products Division. Refer to Catalog 4230/4233 for Installation Instructions and Replacement Components.

D Transportation

E Fittings Series 91

1FN91N Sanitary Flange

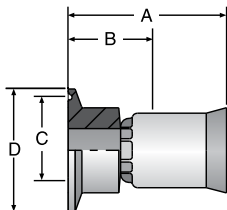

Part Number	Hose Size	A		Cutoff Allow. B		C		Flange Size D	
		inch	mm	inch	mm	inch	mm	inch	mm
#									
1FN91N-16-16C	-16	1.96	50	1-1/16	27	0.87	22	1.98	50

Construction: Stainless steel nipple and shell.

F Tooling, Equipment & Accessories

G General Technical



1J191N Female Seal-Lok™ Swivel 90° Elbow Long Drop

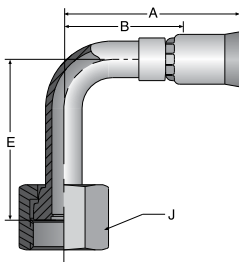

Part Number	Thread Size	Hose Size	A		Cutoff Allow. B		E		J Hex
			inch	mm	inch	mm	inch	mm	inch
#									
1J191N-4-4	9/16-18	-4	1.66	42	1-1/16	27	1.80	46	11/16
1J191N-4-5	9/16-18	-5	1.78	45	1-1/16	27	1.80	46	11/16
1J191N-6-5	11/16-16	-5	1.92	49	1-3/16	30	2.13	54	13/16
1J191N-6-6	11/16-16	-6	1.92	49	1-3/16	30	2.13	54	13/16
1J191N-8-6	13/16-16	-6	2.00	51	1-9/16	40	2.51	43	15/16
1J191N-8-8	13/16-16	-8	2.15	58	1-7/16	37	2.51	64	15/16
1J191N-10-10	1-14	-10	1.25	32	1-9/16	40	2.76	70	1-1/8
1J191N-12-12	1-3/16-12	-12	2.65	67	1-13/16	46	3.78	96	1-3/8
1J191N-16-16	1-7/16-12	-16	3.15	80	2-1/4	57	4.50	114	1-1/2

Construction: Steel tube, nipple, nut and shell.

Add "C" for Stainless Steel.

1J791N Female Seal-Lok™ Swivel 45° Elbow

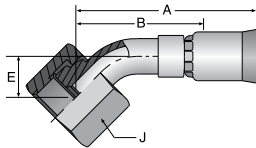

Part Number	Thread Size	Hose Size	A		Cutoff Allow. B		E		J Hex
			inch	mm	inch	mm	inch	mm	inch
#									
1J791N-4-4	9/16-18	-4	1.73	44	1-1/4	32	0.41	10	11/16
1J791N-4-6	9/16-18	-6	1.91	49	1-5/16	33	0.41	10	11/16
1J791N-6-6	11/16-16	-6	2.02	51	1-3/8	35	0.43	11	13/16
1J791N-8-8	13/16-16	-8	2.18	55	1-1/2	38	0.59	15	15/16
1J791N-8-10	13/16-16	-8	2.39	61	1-11/16	43	0.59	15	15/16
1J791N-10-10	1-14	-10	2.47	63	1-3/4	44	0.59	43	1-1/8
1J791N-12-12	1-3/16-12	-12	2.74	58	1-15/16	49	0.81	21	1-3/8
1J791N-16-16	1-7/16-12	-16	3.50	89	2-1/2	64	0.94	24	1-5/8

Construction: Steel tube, nipple, nut and shell.

Add "C" for Stainless Steel.

For detailed ordering information, please consult price list or contact Parflex® Division.

Parker Hannifin Corporation | Parflex® Division | Ravenna, Ohio | parker.com/pfd

www.comoso.com



A Hose
 B Tubing
 C Coiled Air Hose & Fittings
 D Transportation
 E Fittings Series 91
 F Tooling, Equipment & Accessories
 G General Technical

A
Hose

1J991N Female Seal-Lok™ Swivel 90° Elbow Short Drop

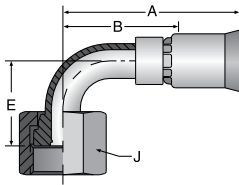

Part Number	Thread Size	Hose Size	A		Cutoff Allow. B		E		J Hex
			inch	mm	inch	mm	inch	mm	inch
#									
1J991N-4-4	9/16-18	-4	1.73	44	1-1/4	32	0.82	21	11/16
1J991N-6-6	11/16-16	-6	1.91	49	1-5/16	33	0.91	23	13/16
1J991N-8-8	13/16-16	-6	2.02	51	1-3/8	35	1.15	29	15/16
1J991N-10-10	1-14	-10	2.18	55	1-1/2	38	1.27	32	1-1/8
1J991N-12-12	1-3/16-12	-12	2.39	61	1-11/16	43	1.85	43	1-3/8
1J991N-16-16	1-7/16-12	-16	2.47	63	1-3/4	44	2.21	56	1-5/8

Construction: Steel tube, nipple, nut and shell.

Add "C" for Stainless Steel.

B
Tubing

C
Coiled Air Hose & Fittings

1JC91N Female Seal-Lok™ Swivel Straight

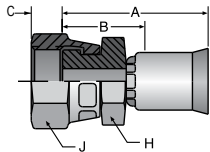

Part Number	Thread Size	Hose Size	A		Cutoff Allow. B		C		H Hex	J Hex
			inch	mm	inch	mm	inch	mm	inch	inch
#										
1JC91N-4-4	9/16-18	-4	1.46	37	5/8	16	.32	8	9/16	11/16
1JC91N-6-6	11/16-16	-6	1.62	41	11/16	17	.32	8	5/8	13/16
1JC91N-8-8	13/16-16	-8	1.93	49	13/16	21	.43	11	3/4	15/16
1JC91N-10-10	1-14	-10	2.05	52	7/8	22	.53	13	15/16	1-1/8
1JC91N-12-10	1-3/16-12	-10	2.05	52	1-1/4	32	.57	14	15/16	1-3/8
1JC91N-12-12	1-3/16-12	-12	2.05	58	1-1/4	32	.57	14	15/16	1-3/8
1JC91N-16-16	1-7/16-12	-16	2.56	65	1-1/16	27	.58	15	1-3/8	1-5/8
1JC91N-20-16	1-11/16-12	-16	2.30	58	1-3/8	35	.59	15	1-5/8	1-7/8
1JC91-20-20	1-11/16-12	-20	2.68	68	1-11/16	43	.59	15	1-11/16	1-7/8

Construction: Steel nipple, nut and shell.

Add "B" for Brass nipple, nut and shell.

Add "C" for Stainless Steel.

D
Transportation

E
Fittings Series 91

F
Tooling, Equipment & Accessories

G
General Technical



1Q191N Ultra Seal

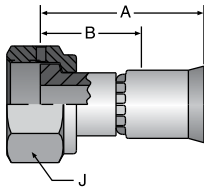

Part Number	Thread Size	Hose Size	A		Cutoff Allow. B		J Hex
			inch	mm	inch	mm	inch
#							
1Q191N-8-8C	7/8-20	-8	1.62	41	15/16	24	1

Construction: Stainless Steel.

1TU91N Universal Tube Stub

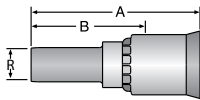

Part Number	Hose Size	Diameter R	A		Cutoff Allow. B	
			inch	mm	inch	mm
#						
1TU91-2-3C	-3	1/8	1.33	34	7/8	22
1TU91-3-3C	-3	3/16	1.33	34	7/8	22
1TU91N-4-4C	-4	1/4	1.63	41	1-1/16	27
1TU91N-4-5C	-5	1/4	1.70	43	1-1/16	27
1TU91N-6-6C	-6	3/8	1.81	46	1-3/16	30
1TU91N-8-8C	-8	1/2	2.72	58	1-7/16	37
1TU91N-8-10C	-10	1/2	2.14	54	1-7/16	37
1TU91N-10-10C	-10	5/8	2.14	54	1-7/16	37
1TU91N-12-12C	-12	3/4	2.24	57	1-7/16	37
1TU91N-16-16C	-16	1	2.73	69	1-3/4	44

Construction: Stainless Steel.

NOTE: Use with A-Lok & CPI nuts, sleeves and adapters. These components are manufactured by Parker's Instrumentation Connectors Division. Refer to catalogs 4230 & 4233 for additional information.

For detailed ordering information, please consult price list or contact Parflex® Division.



A Hose
 B Tubing
 C Coiled Air Hose & Fittings
 D Transportation
 E Fittings Series 91
 F Tooling, Equipment & Accessories
 G General Technical

A
Hose

19291N Female BSP Parallel Pipe Swivel Straight (60° Cone)

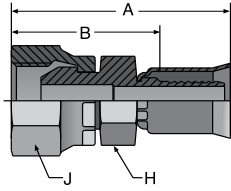

Part Number	Thread Size	Hose Size	A		Cutoff Allow. B		H Hex	J Hex
			inch	mm	inch	mm	inch	inch
#								
19291N-8-8	PF-1/2-14	-8	1.99	51	1-5/16	33	27	27
19291N-12-12	PF-3/4-14	-12	2.35	60	1-9/16	40	36	36

Construction: Steel nipple, nut and shell.

Add "B" for Brass nipple, nut and shell.

Add "C" for Stainless Steel.

B
Tubing

C
Coiled Air Hose
& Fittings

1B291N Female BSP Parallel Pipe Swivel - 90° Elbow (60° Cone)

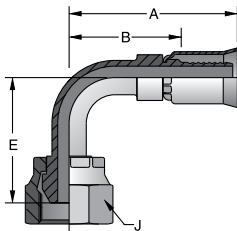

Part Number	Thread Size	Hose Size	A		Cutoff Allow. B		E		J Hex
			inch	mm	inch	mm	inch	mm	inch
#									
1B291N-8-8	PF-1/2-14	-8	2.04	52	1-3/8	35	1.57	40	27
1B291N-12-12	PF-3/4-14	-12	2.93	74	2-1/8	54	2.54	65	36

Construction: Steel nipple, nut and shell.

Add "C" for Stainless Steel.

D
Transportation

E
Fittings
Series 91

F
Tooling, Equipment
& Accessories



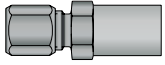
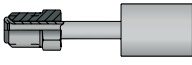
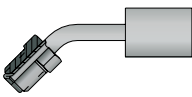
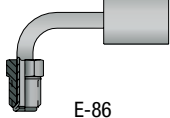

G
General Technical

92 Series Visual Index

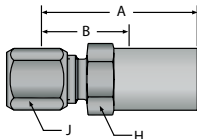
92 Series PERMANENT	111	Ferrule Fix	128	SAE Male Inverted Swivel Straight	167	SAE Male Inverted 45° Elbow	169	SAE Male Inverted 90° Elbow
	 E-85		 E-85		 E-86		 E-86	

11192 Ferrule-Fix (Nut and Sleeve Included)



Part Number	Thread Size	Hose Size		A		Cutoff Allow. B		H Hex	J Hex
		inch	mm	inch	mm	inch	mm	inch	inch
#									
11192-3-3	3/8-24	3/16	5	1.37	35	15/16	24	5/8	7/16

Construction: Steel.

Add "C" for Stainless Steel.



"Ferrule-Fix" affords salvaging of bent tube section of combination tube-hose assemblies and quick, easy repair on the job. See page G-41 for Ferrule-Fix installation instructions.

NOTE: Nut Part Number is 111-size.
Sleeve Part Number is 110-size.

Nuts and Ferrules are Manufactured by the Instrumentation Products Division. Refer to Catalog 4230/4233 for additional information.

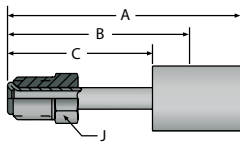
12892 SAE Male Inverted Swivel Straight



Part Number	Thread Size	Hose Size		A		Cutoff Allow. B		C		J Hex
		inch	mm	inch	mm	inch	mm	inch	mm	inch
#										
12892-3-3C	3/8-24	3/16	5	2.01	55	1-1/2	38	1.25	32	7/16

Construction: Stainless Steel.

For detailed ordering information, please consult price list or contact Parflex® Division.

Parker Hannifin Corporation | Parflex® Division | Ravenna, Ohio | parker.com/pfd

www.comoso.com



E-85

A Hose
 B Tubing
 C Coiled Air Hose & Fittings
 D Transportation
 E Fittings Series 92
 F Tooling, Equipment & Accessories
 G General Technical

A Hose

16792 SAE Male Inverted Swivel 45° Elbow

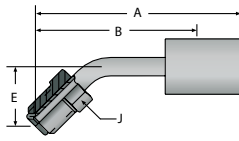

Part Number	Thread Size	Hose Size		A		Cutoff Allow. B		E		J Hex
		inch	mm	inch	mm	inch	mm	inch	mm	inch
#										
16792-3-3C	3/8-24	3/16	5	2.36	60	1-15/16	50	0.62	16	3/8

Construction: Stainless Steel.

B Tubing

C Coiled Air Hose & Fittings

16992 SAE Male Inverted Swivel 90° Elbow

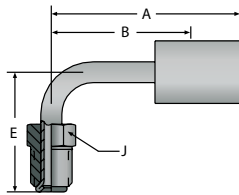

Part Number	Thread Size	Hose Size		A		Cutoff Allow. B		E		J Hex
		inch	mm	inch	mm	inch	mm	inch	mm	inch
#										
16992-3-3C	3/8-24	3/16	5	1.45	37	1	25	1.25	32	3/8

Construction: Stainless Steel.

D Transportation

E Fittings Series 92

F Tooling, Equipment & Accessories

G General Technical



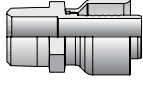
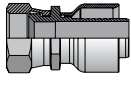
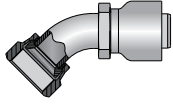
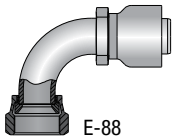
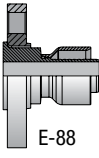
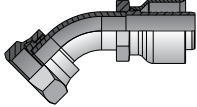
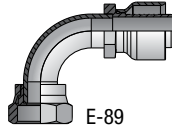
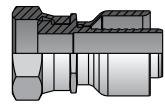

93N Series Visual Index

93N Series PERMANENT	101	Male Taper Pipe Rigid	106	Female JIC 37° Swivel	137	Female JIC 37° Swivel 45° Elbow	139	Female JIC 37° Swivel 90° Elbow Sht.	14K	ANSI B16.5 Flange
	 E-87		 E-87		 E-88		 E-88		 E-88	
 E-89		 E-89		 E-89						

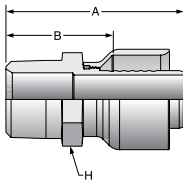
10193N Male Taper Pipe Rigid





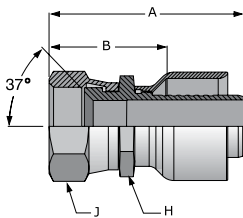

Part Number	Thread Size	Hose Size		A		Cutoff Allow. B		H Hex
		inch	mm	inch	mm	inch	mm	inch
#								
10193N-8-8	1/2-14	1/2	13	2.09	53	1-1/2	38	7/8
10193N-12-12	3/4-14	3/4	19	2.70	69	1-5/8	41	1-1/8
10193N-16-16	1-11-1/2	1	25	3.03	77	1-13/16	46	1-3/8
10193N-20-20	1-1/4-11-1/2	1-1/4	32	3.20	58	1-7/8	48	1-11/16
10193N-24-24	1-1/2-11-1/2	1-1/2	38	3.76	96	2-1/16	52	2
10193N-32-32	2-11-1/2	2	51	3.97	101	2-5/16	59	2-1/2

Construction: Steel nipple, nut and shell.
Add "C" for Stainless Steel.

10693N (JIC) 37° Female Swivel



Part Number	Thread Size	Hose Size		A		Cutoff Allow. B		H Hex	J Hex
		inch	mm	inch	mm	inch	mm	inch	inch
#									
10693N-6-6	9/16-18	3/8	10	1.69	43	1-3/32	28	3/4	11/16
10693N-8-8	3/4-16	1/2	13	2.02	51	1-3/8	35	7/8	7/8
10693N-10-10	7/8-14	5/8	16	2.51	64	1-11/16	43	1	1
10693N-12-12	1-1/16-12	3/4	19	2.86	73	1-3/4	44	1-1/8	1-1/4
10693N-16-16	1-5/16-12	1	25	3.11	79	1-13/16	46	1-3/8	1-1/2
10693N-20-20	1-5/8-12	1-1/4	32	3.28	83	2	51	1-3/4	2
10693N-24-24	1-7/8-12	1-1/2	38	3.92	58	2-1/4	57	2	2-1/4
10693N-32-32	2-1/2-12	2	51	4.12	105	2-7/16	62	2-1/2	2-7/8

Construction: Steel nipple, nut and shell.
Add "C" for Stainless Steel.

For detailed ordering information, please consult price list or contact Parflex® Division.



A Hose
 B Tubing
 C Coiled Air Hose & Fittings
 D Transportation
 E Fittings Series 93
 F Tooling, Equipment & Accessories
 G General Technical

A Hose

13793N JIC 37° Swivel 45° Elbow

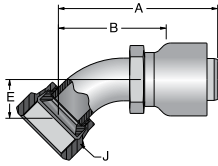

Part Number	Thread Size	Hose Size	A		Cutoff Allow. B		E		J Hex
			inch	mm	inch	mm	inch	mm	inch
#									
13793N-12-12	1-1/16-12	-12	3.37	86	2-1/4	57	.78	20	1-1/4
13793N-16-16	1-5/16-12	-16	3.71	94	2-5/8	67	.90	23	1-1/2
13793N-20-20	1-5/8-12	-20	4.06	103	2-3/4	70	1.18	43	2
13793N-24-24	1-7/8-12	-24	5.76	146	4-1/4	108	1.47	37	2-1/4

Construction: Steel nipple, nut and shell.
Add "C" for Stainless Steel.

B Tubing

C Coiled Air Hose & Fittings

13993N JIC 37° Swivel 90° Elbow Short Drop

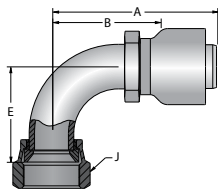

Part Number	Thread Size	Hose Size	A		Cutoff Allow. B		E		J Hex
			inch	mm	inch	mm	inch	mm	inch
#									
13993N-8-8	3/4-16	-8	2.20	56	1-9/16	40	1.09	28	7/8
13993N-10-10	7/8-14	-10	2.41	61	1-11/16	43	1.23	31	1
13993N-12-12	1-1/16-12	-12	3.28	83	2-3/16	56	1.82	46	1-1/4
13993N-16-16	1-5/16-12	-16	3.71	94	2-1/2	64	2.14	54	1-1/2
13993N-20-20	1-5/8-12	-20	3.89	99	2-9/16	65	2.57	43	2
13993N-24-24	1-7/8-12	-24	5.72	58	4-1/4	108	3.17	81	2-1/4

Construction: Steel nipple, nut and shell.
Add "C" for Stainless Steel.

D Transportation

E Fittings Series 93

14K93N ANSI B16.5 Flange

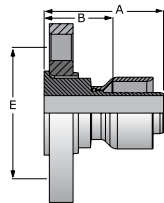

Part Number	Hose Size		Flange Diameter		A		Cutoff Allow. B		Bolt Spacing E	
	inch	mm	inch	mm	inch	mm	inch	mm	inch	mm
#										
14K93N-8-8	1/2	13	3-1/2	89	2.03	52	1-3/8	35	2-3/8	60
14K93N-12-12	3/4	19	3-7/8	98	2.70	69	1-3/4	44	2-3/4	70
14K93N-16-16	1	25	4-1/4	108	2.84	72	1-5/8	41	3-1/8	79
14K93N-20-20	1-1/4	32	4-5/8	117	2.98	76	1-5/8	41	3-1/2	89
14K93N-24-24	1-1/2	38	5	127	3.45	88	1-3/4	44	3-7/8	98
14K93N-32-32	2	51	6	152	3.62	58	2	51	4-3/4	121

Construction: Steel nipple and shell, stainless steel flange.
NOTE: Also available in PAGE Fittings.

F Tooling, Equipment & Accessories

G General Technical



1JC93N Seal-Lok™ Swivel Straight Short

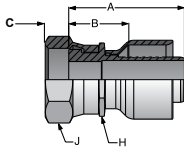

Part Number	Thread Size	Hose Size		A		Cutoff Allow. B		C		H Hex	J Hex
		inch	mm	inch	mm	inch	mm	inch	mm	inch	inch
#											
1JC93N-12-12	1-3/16-12	3/4	19	2.30	58	1-3/8	35	.57	14	1-3/8	1-3/8
1JC93N-16-16	1-7/16-12	1	25	2.61	66	1-3/8	35	.58	15	1-3/8	1-5/8
1JC93N-20-20	1-11/16-12	1-1/4	32	2.65	67	1-5/16	33	.59	15	1-7/8	1-7/8

Construction: Steel nipple, nut and shell. Add "C" for Stainless Steel.

NOTE: Also available in PAGE Fittings. When measuring overall length to the end of the nut, B+C dimensions must be used to calculate cut-off allowance. Stainless steel fittings must be assembled with Karrykrimp2 or Parkimp2. See CrimpSource for more information.

1J793N Seal-Lok™ 45° Elbow

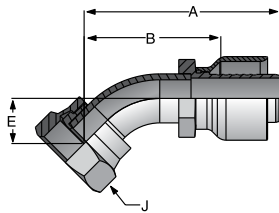

Part Number	Thread Size	Hose Size		A		Cutoff Allow. B		E		J Hex
		inch	mm	inch	mm	inch	mm	inch	mm	inch
#										
1J793N-20-20	1-11/16-12	1-1/4	32	4.25	108	2-15/16	75	1.00	25	1-7/8

Construction: Steel nipple, tube, nut and shell.

Add "C" for Stainless Steel.

NOTE: Also available in PAGE Fittings.

1J993N Seal-Lok™ 90° Elbow Short Drop

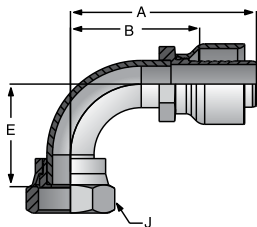

Part Number	Thread Size	Hose Size		A		Cutoff Allow. B		E		J Hex
		inch	mm	inch	mm	inch	mm	inch	mm	inch
#										
1J993N-20-20	1-11/16-12	1-1/4	32	4.36	111	3-1/16	78	2.51	64	1-7/8

Construction: Steel nipple, tube, nut and shell.

Add "C" for Stainless Steel.

NOTE: Also available in PAGE Fittings.

For detailed ordering information, please consult price list or contact Parflex® Division.

Parker Hannifin Corporation | Parflex® Division | Ravenna, Ohio | parker.com/pfd

www.comoso.com



A Hose
 B Tubing
 C Coiled Air Hose & Fittings
 D Transportation
 E Fittings Series 93
 F Tooling, Equipment & Accessories
 G General Technical

A Hose
 B Tubing
 C Coiled Air Hose & Fittings
 D Transportation
 E Fittings Series 94/95
 F Tooling, Equipment & Accessories
 G General Technical

94/95 Series Visual Index

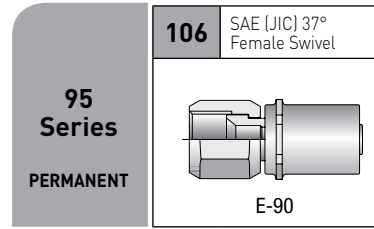
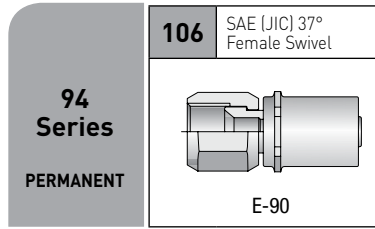

10694 SAE (JIC) 37° Female Swivel

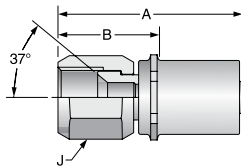

Part Number	Thread Size	Hose Size	A		Cutoff Allow. B		J Hex
			inch	mm	inch	mm	
#							
10694-6-6	9/16-18	-6	1.76	45	15/16	24	11/16
10694-8-8	3/4-16	-8	2.09	53	1-3/16	30	7/8
10694-10-10	7/8-14	-10	2.30	58	1-5/16	33	1
10694-12-12	1-1/16-12	-12	2.45	62	1-5/16	33	1-1/4
10694-16-16	1-5/16-12	-16	2.72	69	1-7/16	37	1-1/2

Construction: Steel nipple, nut and shell.
 Add "C" for Stainless Steel.

10695 SAE (JIC) 37° Female Swivel

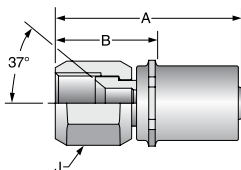

Part Number	Thread Size	Hose Size	A		Cutoff Allow. B		J Hex
			inch	mm	inch	mm	
#							
10695-4-4	7/16-20	-4	1.76	45	15/16	24	11/16
10695-6-6	9/16-18	-6	2.09	53	1-3/16	30	7/8
10695-8-8	3/4-16	-8	2.30	58	1-5/16	33	1
10695-12-12	1-1/16-12	-12	2.45	62	1-5/16	33	1-1/4
10695-16-16	1-5/16-12	-16	2.72	69	1-7/16	37	1-1/2

Construction: Steel nipple, nut and shell.
 Add "C" for Stainless Steel.

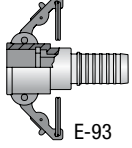
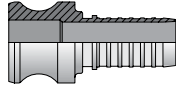
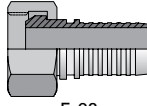
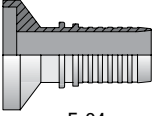
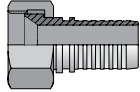
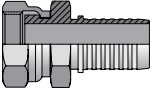
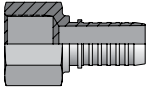
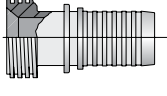
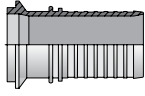
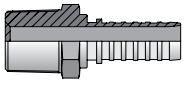
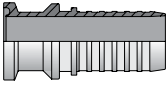
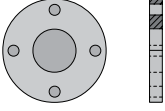
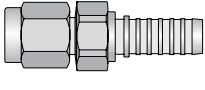
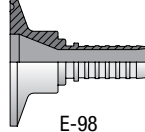
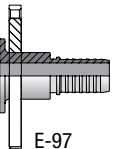
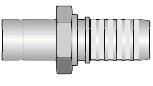

PAGE Fittings Visual Index

PAGE Fittings PERMANENT	CL-S Female Cam & Groove  E-93	E-S Male Cam & Groove  E-93	FBS-S Female Sanitary Bevel Seat  E-93	FIL-S Female I-Line® Sanitary  E-94	FJX-S Female JIC 37° Swivel  E-96	
	FORFS-S Female Seal-Lok™ Swivel Short  E-96	FP-S Female NPTF Pipe Rigid  E-95	MBS-S Male Sanitary Bevel Seat  E-94	MIL-S Male I-Line® Sanitary  E-94	MP-S Male NPTF Pipe Rigid  E-95	
	MSAN-S Mini Sanitary Flange  E-98	PF ANSI Flange  E-97	PLCF-S Female A-Lok® Compression  E-96	SAN-S Sanitary Flange & Step Downs  E-98	SFR-S Flange Retainer  E-97	
	TUBE-S A-Lok® Male Stand pipe-Rigid "V" Notch  E-97					

NOTE:

The PAGE fitting call-out does not follow traditional Parker fitting nomenclature. The end size and hose size are reversed.

PAGE fittings require a PAGE collar. See pg. E-92.

Length calculations for PAGE hose assemblies are typically made sealing surface to sealing surface per the NAHAD Fluoropolymer Hose Assembly Specification Guidelines unless otherwise requested by customer at time of order.

For detailed ordering information, please consult price list or contact Parflex® Division.

Parker Hannifin Corporation | Parflex® Division | Ravenna, Ohio | parker.com/pfd

www.comoso.com



E-91

A
Hose

B
Tubing

C
Coiled Air Hose & Fittings

D
Transportation

E
Fittings Series PAGE

F
Tooling, Equipment & Accessories

G
General Technical

PAGE Fitting Collars - Size & Style

PAGE COLLARS	Hose	Collar # Size	04	06	08	12	16	20	24	32	40	48	64
	STW STB	ST300	ST300	ST300	ST300	ST300	ST300	ST300	ST300	ST300			
SCW SCB	SC300	SC300	SC300	SC300	SC300	SC300	SC300	SC300	SC300	SC300			
PCW PCB	PC300	PC300	PC300	PC300	PC300	PC300	PC300	PC300	PC300	PC300			
SCWV SCBV	SC300			SC300	SC300	SC300	SC300	SC300	SC300	SC300	SC300	SC300	SC300
PCWV PCBV	PC300			PC300	PC300	PC300	PC300	PC300	PC300	PC300	PC300	PC300	PC300
SBFW SBFB	SBF300		SBF300	SBF300	SBF300	SBF300		SBF300					
RCTW RCTB	RC300			RC300	RC300	RC300	RC300	RC300	RC300	RC300	RC300	RC300	RC300

By Size

Inserts & Collars Sold Separately

Examples:

If you need a Female JIC Swivel Fitting for a 08-SCW Hose (1/2" Convolute), place an order for (1) 08-08 FJX-S and (1) 08-SC300.

If you need a Male Pipe Fitting for a 12-RCTW Hose, place an order for (1) 12-12 MP-S and (1) 12-RC300.

By Style

Size	ST300	SC300	PC300	SBF300	RC300
	For use with STW/STB	For use with SCW/SCB, SCWV/SCBV	For use with PCW/PCB, PCWV/PCBV	For use with SBFW/SBFB	For use with RCTW/RCTB
1/4"	04-ST300	04-SC300	04-PC300	—	—
3/8"	06-ST300	06-SC300	06-PC300	06-SBF300	—
1/2"	08-ST300	08-SC300	08-PC300	08-SBF300	08-RC300
3/4"	12-ST300	12-SC300	12-PC300	12-SBF300	12-RC300
1"	16-ST300	16-SC300	16-PC300	16-SBF300	16-RC300
1-1/4"	20Z-ST300	20-SC300	20-PC300	—	20-RC300
1-1/2"	24Z-ST300	24-SC300	24-PC300	24-SBF300	24-RC300
2"	—	32-SC300	32-PC300	—	32-RC300
3"	—	48-SC300	48-PC300	—	48-RC300
4"	—	64-SC300	64-PC300	—	64-RC300

Construction: Stainless Steel.

NOTE: also available in carbon steel "CS".

NOTE: The PAGE fitting call-out does not follow traditional Parker fitting nomenclature. The end size and hose size are reversed. Length calculations for PAGE hose assemblies are typically made sealing surface to sealing surface per the NAHAD Fluoropolymer Hose Assembly Specification Guidelines unless otherwise requested by customer at time of order.



For detailed ordering information, please consult price list or contact Parflex® Division.

Parker Hannifin Corporation | Parflex® Division | Ravenna, Ohio | parker.com/pfd

www.comoso.com

CL-S Female Cam & Groove

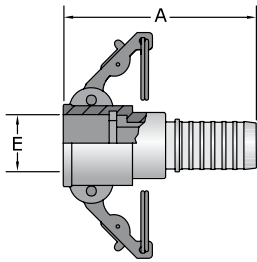

Part Number	Hose I.D.		A		E	
	inch	mm	inch	mm	inch	mm
#	⊙					
16-16CL-S	1	25	4.2	107	1.44	37
24-24CL-S	1-1/2	38	5.2	132	2.10	53
32-32CL-S	2	51	6.0	152	2.48	63
48-48CL-S	3	76	7.2	183	3.60	91
64-64CL-S	4	102	7.8	198	4.70	119

Construction: Stainless Steel.

NOTE: Also available as encapsulated female cam under part number TEC-S and TECL-S.

E-S Male Cam & Groove

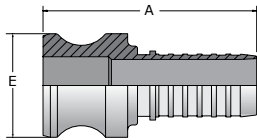

Part Number	Hose I.D.		A		E	
	inch	mm	inch	mm	inch	mm
#	⊙					
12-12E-S	3/4	19	2.60	66	1.26	32
16-16E-S	1	25	2.91	74	1.44	37
20-20E-S	1-1/4	32	3.64	93	1.78	45
24-24E-S	1-1/2	38	4.03	102	2.10	53
32-32E-S	2	51	4.75	121	2.48	63
48-48E-S	3	76	5.75	146	3.60	91
64-64E-S	4	102	5.88	149	4.70	119

Construction: Stainless Steel.

FBS-S Female Sanitary Bevel Seat

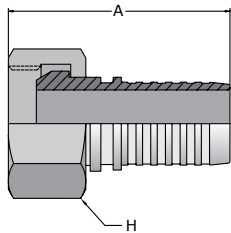

Part Number	Acme Thread	Hose I.D.		A	
		inch	mm	inch	mm
#		⊙			
16-16FBS-S	1-1/2-8	1	25	2.74	70
24-24FBS-S	2-8	1-1/2	38	3.41	87
32-32FBS-S	2-1/2-8	2	51	3.94	100
40-40FBS-S	3-8	2-1/2	64	4.37	110
48-48FBS-S	3-1/2-8	3	76	4.85	123
64-64FBS-S	4-5/8-6	4	102	5.24	133

Construction: Stainless Steel.

NOTE: The PAGE fitting call-out does not follow traditional Parker fitting nomenclature. The end size and hose size are reversed. Length calculations for PAGE hose assemblies are typically made sealing surface to sealing surface per the NAHAD Fluoropolymer Hose Assembly Specification Guidelines unless otherwise requested by customer at time of order.

For detailed ordering information, please consult price list or contact Parflex® Division.

Parker Hannifin Corporation | Parflex® Division | Ravenna, Ohio | parker.com/pfd

www.comoso.com



E-93

A
Hose

B
Tubing

C
Coiled Air Hose
& Fittings

D
Transportation

E
Fittings
Series PAGE

F
Tooling, Equipment
& Accessories

G
General Technical

A
Hose

MBS-S Male Sanitary Bevel Seat

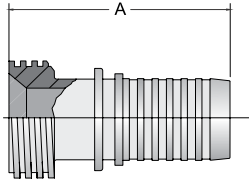

Part Number	Acme Thread	Hose I.D.		A	
		inch	mm	inch	mm
#					
16-16MBS-S	1-1/2-8	1	25	2.74	70
24-24MBS-S	2-8	1-1/2	38	3.41	87
32-32MBS-S	2-1/2-8	2	51	3.94	100
40-40MBS-S	3-8	2-1/2	64	4.37	110
48-48MBS-S	3-1/2-8	3	76	4.85	123
64-64MBS-S	4-5/8-6	4	102	5.24	133

Construction: Stainless Steel.

B
TubingC
Coiled Air Hose
& Fittings

FIL-S Female I-Line® Sanitary

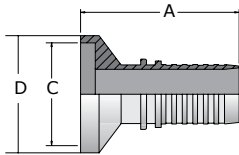

Part Number	Hose I.D.	A		Flange Size C		D		
		inch	mm	inch	mm	inch	mm	
#								
16-16FIL-S	1	25	2.60	66	1.25	32	2.00	51
24-24FIL-S	1-1/2	38	3.43	87	1.76	45	2.00	51
32-32FIL-S	2	51	4.23	107	2.26	57	2.64	67
40-40FIL-S	2-1/2	64	4.42	112	2.76	70	3.31	84
48-48FIL-S	3	76	4.84	123	3.31	84	3.87	98

Construction: Stainless Steel.

D
TransportationE
Fittings
Series PAGE

MIL-S Male I-Line® Sanitary

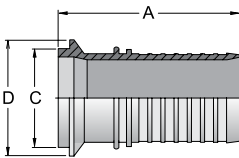

Part Number	Hose I.D.	A		Flange Size C		D		
		inch	mm	inch	mm	inch	mm	
#								
16-16MIL-S	1	13	2.60	66	1.25	32	2.00	51
24-24MIL-S	1-1/2	19	3.43	87	1.76	45	2.00	51
32-32MIL-S	2	25	4.23	107	2.26	57	2.64	67
40-40MIL-S	2-1/2	64	4.42	112	2.76	70	3.31	84
48-48MIL-S	3	76	4.84	123	3.31	84	3.87	98

Construction: Stainless Steel.

F
Tooling, Equipment
& AccessoriesG
General Technical

NOTE: The PAGE fitting call-out does not follow traditional Parker fitting nomenclature. The end size and hose size are reversed. Length calculations for PAGE hose assemblies are typically made sealing surface to sealing surface per the NAHAD Fluoropolymer Hose Assembly Specification Guidelines unless otherwise requested by customer at time of order.



For detailed ordering information, please consult price list or contact Parflex® Division.

FP-S Female NPTF Pipe-Rigid

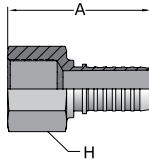

Part Number	Thread Size	Hose I.D.		A		H Hex
		inch	mm	inch	mm	inch
#						
04-04FP-S	1/4-18	1/4	6	1.63	41	3/4
06-06FP-S	3/8-18	3/8	10	1.73	44	7/8
08-08FP-S	1/2-14	1/2	13	2.25	57	1-1/16
12-12FP-S	3/4-14	3/4	19	2.60	66	1-5/16
16-16FP-S	1-11 1/2	1	25	2.85	72	1-5/8
20-20FP-S	1 1/4-11 1/2	1-1/4	32	3.50	89	2
24-24FP-S	1 1/2-11 1/2	1-1/2	38	3.63	92	2-3/8
32-32FP-S	2-11 1/2	2	51	4.25	108	2-7/8

Construction: Stainless Steel.

MP-S Male NPTF Pipe-Rigid

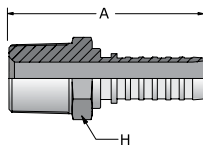

Part Number	Thread Size	Hose I.D.		A		H Hex
		inch	mm	inch	mm	inch
#						
04-04MP-S	1/4-18	1/4	6	1.63	41	9/16
06-06MP-S	3/8-18	3/8	10	1.76	45	11/16
08-08MP-S	1/2-14	1/2	13	2.34	59	7/8
12-12MP-S	3/4-14	3/4	19	2.59	66	1-1/8
16-16MP-S	1-11 1/2	1	25	3.00	76	1-3/8
20-20MP-S	1 1/4-11 1/2	1-1/4	32	3.39	86	1-3/4
24-24MP-S	1 1/2-11 1/2	1-1/2	38	3.89	99	2
32-32MP-S	2-11 1/2	2	51	4.58	116	2-1/2
40-40MP-S	2-1/2 8	2-1/2	64	5.28	134	3
48-48MP-S	3-8	3	76	5.93	151	3-3/4
64-64MP-S	4-8	4	102	6.82	173	4-5/8

Construction: Stainless Steel.

NOTE: The PAGE fitting call-out does not follow traditional Parker fitting nomenclature. The end size and hose size are reversed. Length calculations for PAGE hose assemblies are typically made sealing surface to sealing surface per the NAHAD Fluoropolymer Hose Assembly Specification Guidelines unless otherwise requested by customer at time of order.

For detailed ordering information, please consult price list or contact Parflex® Division.

Parker Hannifin Corporation | Parflex® Division | Ravenna, Ohio | parker.com/pfd

www.comoso.com



E-95

A
Hose

B
Tubing

C
Coiled Air Hose
& Fittings

D
Transportation

E
Fittings
Series PAGE

F
Tooling, Equipment
& Accessories

G
General Technical

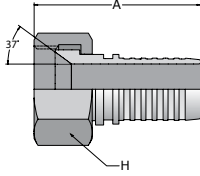
A
Hose**FJX-S Female JIC 37° Swivel**

Part Number	Thread Size	Hose I.D.		A		H Hex
		inch	mm	inch	mm	inch
#						
04-04FJX-S	7/16-20	1/4	6	1.44	37	9/16
06-06FJX-S	9/16-18	3/8	10	1.65	42	11/16
08-08FJX-S	3/4-16	1/2	13	2.13	54	7/8
12-12FJX-S	1-1/16-12	3/4	19	2.54	65	1-1/4
16-16FJX-S	1-5/16-12	1	25	2.76	70	1-1/2
20-20FJX-S	1-5/8-12	1-1/4	32	3.25	83	2
24-24FJX-S	1-7/8-12	1-1/2	38	3.73	95	2-1/4
32-32FJX-S	2-1/2-12	2	51	4.55	116	2-7/8
40-40FJX-S	3-12	2-1/2	64	4.76	121	3-3/8

Construction: Stainless Steel.

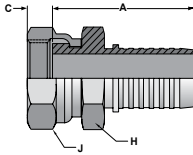
B
TubingC
Coiled Air Hose
& Fittings**FORFS-S Female Seal-Lok® Swivel-Short**

Part Number	Thread Size	Hose I.D.		A		C		H Hex	J Hex
		inch	mm	inch	mm	inch	mm	inch	inch
#									
04-04FORFS-S	9/16-18	1/4	6	1.50	38	.32	8	9/16	11/16
06-06FORFS-S	11/16-16	3/8	10	1.85	47	.32	8	11/16	13/16
08-08FORFS-S	13/16-16	1/2	13	2.00	51	.43	11	13/16	15/16
12-12FORFS-S	1-3/16-12	3/4	19	2.30	58	.57	14	1-1/8	1-3/8
16-16FORFS-S	1-7/16-12	1	25	2.50	64	.58	15	1-3/8	1-5/8
24-24FORFS-S	2-12	1-1/2	38	3.98	101	.59	15	2	2-1/4

Construction: Stainless Steel.

NOTE: When measuring overall length to the end of the nut, B+C dimensions must be used to calculate cut-off allowance. Stainless steel fittings must be assembled with Karrykrimp2 or Parkrimp2. See CrimpSource for more information.

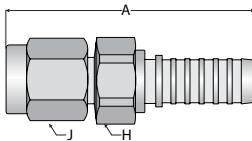
D
TransportationE
Fittings
Series PAGE**PLCF-S Female A-LOK® Compression (With Nut & Ferrules)**

Part Number	Thread Size	Hose I.D.		A		H Hex	J Hex
		inch	mm	inch	mm	inch	inch
#							
04-04PLCF-S	7/16-20	1/4	6	1.52	39	9/16	9/16
06-06PLCF-S	9/16-20	3/8	10	1.63	41	11/16	11/16
08-08PLCF-S	3/4-20	1/2	13	2.05	52	7/8	7/8
12-12PLCF-S	1-20	3/4	19	2.30	58	1-1/8	1-1/8
16-16PLCF-S	1-5/16-20	1	25	2.57	65	1-3/8	1-1/2

Construction: Stainless Steel.

NOTE: The PAGE fitting call-out does not follow traditional Parker fitting nomenclature. The end size and hose size are reversed. Length calculations for PAGE hose assemblies are typically made sealing surface to sealing surface per the NAHAD Fluoropolymer Hose Assembly Specification Guidelines unless otherwise requested by customer at time of order.

F
Tooling, Equipment
& AccessoriesG
General Technical

For detailed ordering information, please consult price list or contact Parflex® Division.

TUBE-S A-LOK® Male Standpipe-Rigid with "V" Notch

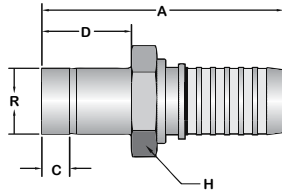

Part Number	Diameter R		Hose I.D.		A		C		D		H Hex
	inch	mm	inch	mm	inch	mm	inch	mm	inch	mm	inch
#	/		⊙								⬡
04-04TUBE-S	1/4	6	1/4	6	1.75	45	.18	5	.66	17	7/16
06-06TUBE-S	3/8	10	3/8	10	2.06	52	.25	6	.85	2	5/8
08-08TUBE-S	1/2	13	1/2	13	2.56	65	.34	9	.97	25	3/4
12-12TUBE-S	3/4	19	3/4	19	2.86	73	.40	10	1.02	26	1-1/8
16-16TUBE-S	1	25	1	25	3.34	85	.52	13	1.30	33	1-3/8
20-20TUBE-S	1-1/4	32	1-1/4	32	4.05	10	.50	13	1.75	45	1-3/4

Construction: Stainless Steel.

PF ANSI B16.5 Flange

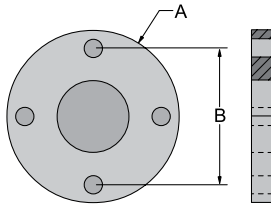

Carbon Steel (Epoxy Coated)	316 Stainless Steel	304 Stainless Steel	Flange Diameter A		Hose I.D.		Bolt Spacing B	
#	#	#	/		⊙			
Flange	Flange	Flange	inch	mm	inch	mm	inch	mm
08-PF150	08-PF156	08-PF154	3-1/2	89	1/2	13	2-3/8	60
12-PF150	12-PF156	12-PF154	3-7/8	98	3/4	19	2-3/4	70
16-PF150	16-PF156	16-PF154	4-1/4	108	1	25	3-1/8	79
20-PF150	20-PF156	20-PF154	4-5/8	117	1-1/4	32	3-1/2	89
24-PF150	24-PF156	24-PF154	5	127	1-1/2	38	3-7/8	98
32-PF150	32-PF156	32-PF154	6	152	2	51	4-3/4	120
40-PF150	40-PF156	40-PF154	7	178	2-1/2	64	5-1/2	140
48-PF150	48-PF156	48-PF154	7-1/2	191	3	76	6	152
64-PF150	64-PF156	64-PF154	9	229	4	102	7-1/2	191

NOTE: Also available in 300 lb. flange and other materials. Contact Customer Service for options.

SFR-S Flange Retainer

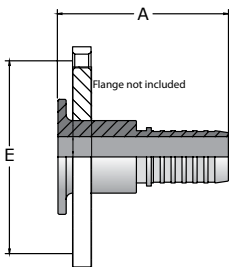

Part Number	Flange Diameter		Hose I.D.		A		Bolt Spacing E	
#	⊙		⊙					
	inch	mm	inch	mm	inch	mm	inch	mm
08-08SFR-S	3-1/2	89	1/2	13	2.30	58	2-3/8	60
12-12SFR-S	3-7/8	98	3/4	19	2.60	66	2-3/4	70
16-16SFR-S	4-1/4	108	1	25	3.00	76	3-1/8	79
20-20SFR-S	4-5/8	117	1-1/4	32	3.25	83	3-1/2	89
24-24SFR-S	5	127	1-1/2	38	3.65	93	3-7/8	98
32-32SFR-S	6	152	2	51	4.25	108	4-3/4	120
40-40SFR-S	7	178	2-1/2	64	5.00	127	5-1/2	140
48-48SFR-S	7-1/2	191	3	76	5.50	140	6	152
64-64SFR-S	9	229	4	102	7.00	178	7-1/2	191

Construction: Stainless Steel.

NOTE: The PAGE fitting call-out does not follow traditional Parker fitting nomenclature. The end size and hose size are reversed. Length calculations for PAGE hose assemblies are typically made sealing surface to sealing surface per the NAHAD Fluoropolymer Hose Assembly Specification Guidelines unless otherwise requested by customer at time of order.

For detailed ordering information, please consult price list or contact Parflex® Division.

Parker Hannifin Corporation | Parflex® Division | Ravenna, Ohio | parker.com/pfdwww.comoso.com

E-97

A Hose

B Tubing

C Coiled Air Hose & Fittings

D Transportation

E Fittings Series PAGE

F Tooling, Equipment & Accessories

G General Technical

A
Hose

MSAN-S Mini Sanitary Flange

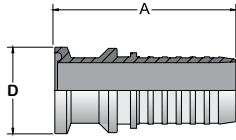

Part Number	Hose I.D.		A		Flange Size D	
	inch	mm	inch	mm	inch	mm
#	⊙					
04-04MSAN-S	1/4	6	1.47	37	.98	25
04-08MSAN-S	1/4	6	1.50	38	.98	25
06-06MSAN-S	3/8	10	1.53	39	.98	25
06-08MSAN-S	3/8	10	1.53	39	.98	25
06-12MSAN-S	3/8	10	1.66	42	.98	25
08-08MSAN-S	1/2	13	1.90	48	.98	25
08-12MSAN-S	1/2	13	1.94	49	.98	25
12-12MSAN-S	3/4	19	2.16	55	.98	25
16-16MSAN-S	1	25	2.27	58	1.34	34

Construction: Stainless Steel. Compliant ASME-BPE

NOTE: The PAGE fitting call-out does not follow traditional Parker fitting nomenclature. The end size and hose size are reversed.

NOTE: The PAGE fitting call-out does not follow traditional Parker fitting nomenclature. The end size and hose size are reversed. Length calculations for PAGE hose assemblies are typically made sealing surface to sealing surface per the NAHAD Fluoropolymer Hose Assembly Specification Guidelines unless otherwise requested by customer at time of order.

B
TubingC
Coiled Air Hose & FittingsD
Transportation

SAN-S Sanitary Flange & Step-Downs

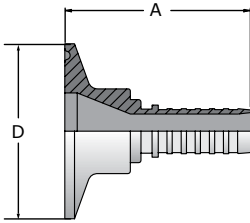

Part Number	Hose I.D.		A		Flange Size D	
	inch	mm	inch	mm	inch	mm
#	⊙					
08-08SAN-S	1/2	13	2.11	54	1.98	50
08-16SAN-S	1/2	13	2.11	54	1.98	50
08-24SAN-S	1/2	13	2.34	59	1.98	50
12-12SAN-S	3/4	19	2.32	59	1.98	50
16-16SAN-S	1	25	2.45	62	1.98	50
12-24SAN-S	3/4	19	2.34	59	1.98	50
16-24SAN-S	1	25	2.32	59	1.98	50
24-24SAN-S	1-1/2	38	3.10	79	1.98	50
24-32SAN-S	1-1/2	38	3.12	79	2.52	64
32-32SAN-S	2	51	3.67	93	2.52	64
40-40SAN-S	2-1/2	64	4.00	102	3.05	77
48-48SAN-S	3	76	4.50	114	3.58	91
64-64SAN-S	4	102	4.75	121	4.68	119

Construction: Stainless Steel. Compliant ASME-BPE

NOTE: The PAGE fitting call-out does not follow traditional Parker fitting nomenclature. The end size and hose size are reversed.



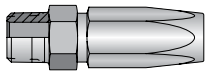
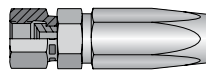

E
Fittings Series PAGEF
Tooling, Equipment & AccessoriesG
General Technical

BA Series Visual Index

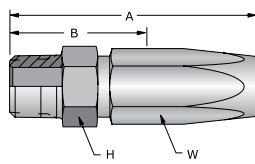
BA Series FIELD ATTACHABLE	201	Male Taper Pipe Rigid	206	SAE (JIC) 37° Swivel
	 E-99		 E-99	

201BA Male Taper Pipe Rigid





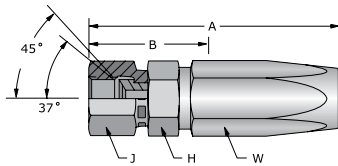

Part Number	Thread Size	Hose I.D.		A		Cutoff Allow. B		H Hex	W Hex
		inch	mm	inch	mm	inch	mm	inch	inch
#									
201BA-4-4	1/4-18	1/4	6	2.43	62	1-1/4	32	5/8	3/4
201BA-6-6	3/8-18	3/8	10	2.62	67	1-1/4	32	3/4	7/8

Construction: Steel.

206BA Female SAE (JIC) 37° Swivel



Part Number	Thread Size	Hose I.D.		A		Cutoff Allow. B		H Hex	J Hex	W Hex
		inch	mm	inch	mm	inch	mm	inch	inch	inch
#										
206BA-6-4	9/16-18	1/4	6	2.62	67	1-3/8	35	11/16	11/16	3/4
206BA-6-6	9/16-18	3/8	10	2.76	70	1-3/8	35	3/4	3/4	7/8
206BA-8-8	3/4-16	1/2	13	3.26	83	1-11/16	43	7/8	7/8	1-1/16

Construction: Steel.

NOTE: Size -8 incorporates a dual seat.

For detailed ordering information, please consult price list or contact Parflex® Division.

Parker Hannifin Corporation | Parflex® Division | Ravenna, Ohio | parker.com/pfd

www.comoso.com



E-99

A
Hose

B
Tubing

C
Coiled Air Hose & Fittings

D
Transportation

E
Fittings Series BA

F
Tooling, Equipment & Accessories



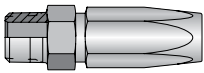
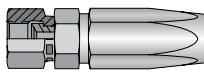
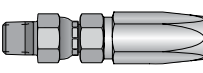

G
General Technical

BU Series Visual Index

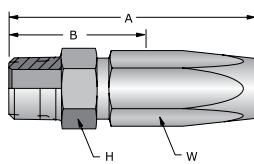
BU Series PERMANENT	201 Male Taper Pipe Rigid	206 SAE (JIC) 37° Swivel	213 Male Taper Pipe Swivel
			
	E-100	E-100	E-100

201BU Male Taper Pipe Rigid





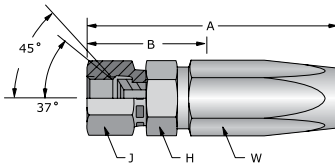

Part Number	Thread Size	Hose I.D.		A		Cutoff Allow. B		H Hex	W Hex
		inch	mm	inch	mm	inch	mm	inch	inch
#									
201BU-2-2	1/8-27	1/8	3	1.50	38	1	25	7/16	7/16

Construction: Steel.

206BU Female SAE (JIC) 37° Swivel







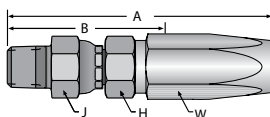

Part Number	Thread Size	Hose I.D.		A		Cutoff Allow. B		H Hex	J Hex	W Hex
		inch	mm	inch	mm	inch	mm	inch	inch	inch
#										
206BU-3-2	3/8-24	1/8	3	1.72	44	1-3/16	30	1/2	9/16	7/16
206BU-4-2	7/16-20	1/8	3	1.77	45	1-3/16	30	9/16	9/16	7/16
206BU-4-3	7/16-20	1/8	3	1.89	48	1-1/16	27	9/16	9/16	7/16

Construction: Steel.

NOTE: Size -4 incorporates a dual seat.

213BU Male Taper Pipe Swivel



Part Number	Thread Size	Hose I.D.		A		Cutoff Allow. B		H Hex	J Hex	W Hex
		inch	mm	inch	mm	inch	mm	inch	inch	inch
#										
213BU-2-2	1/8-27	1/8	3	2.07	53	1-1/2	38	1/2	1/2	7/16

Construction: Steel.

WARNING: Fittings allow minor movement to relieve stress on hose but are not recommended for continued or extensive swiveling. Not recommended for use in CNG applications.

CY Series Visual Index

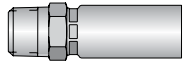
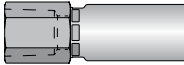
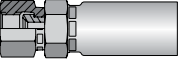
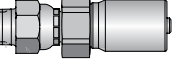
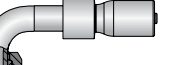
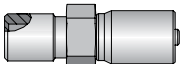
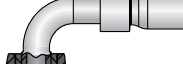
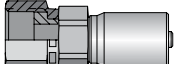
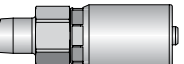
CY Series PERMANENT	101 Male Taper Pipe Rigid	102 Female Pipe Thread	106 Female SAE JIC 37° Swivel	113 Male Pipe Swivel	139 Female JIC 37° Swivel 90° Elbow Sht.
	 E-102	 E-102	 E-102	 E-103	 E-103
	1GK Bulkhead w/Zerk Port Integrated	1J9 Female Seal-Lok™ 90° Elbow Sht.	1JC Female Seal-Lok™ Swivel Straight Short	1LM Male Grease	
 E-103	 E-104	 E-104	 E-104		

A
Hose

B
Tubing

C
Coiled Air Hose & Fittings

D
Transportation

E
Fittings Series CY

F
Tooling, Equipment & Accessories

G
General Technical

For detailed ordering information, please consult price list or contact Parflex® Division.

Parker Hannifin Corporation | Parflex® Division | Ravenna, Ohio | parker.com/pfd

www.comoso.com



A Hose

101CY Male Taper Pipe Rigid

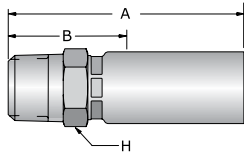

Part Number	Thread Size	Hose I.D.		A		Cutoff Allow. B		H Hex
		inch	mm	inch	mm	inch	mm	inch
#								
101CY-2-2	1/8-27	1/8	3	1.31	33	13/16	21	7/16
101CY-2-3	1/8-27	3/16	5	1.72	44	15/16	24	1/2
101CY-4-2	1/4-18	1/8	3	1.51	38	1	25	9/16
101CY-4-3	1/4-18	3/16	5	1.91	49	1-1/8	29	9/16

Construction: Steel.
Add "C" for Stainless Steel.

B Tubing

C Coiled Air Hose & Fittings

102CY Female Pipe Thread

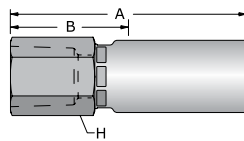

Part Number	Thread Size	Hose I.D.		A		Cutoff Allow. B		H Hex
		inch	mm	inch	mm	inch	mm	inch
#								
102CY-2-3	1/8-27	3/16	5	1.97	50	1-1/16	27	1/2

Construction: Steel.
Add "C" for Stainless Steel.

D Transportation

106CY Female SAE (JIC) 37° Swivel

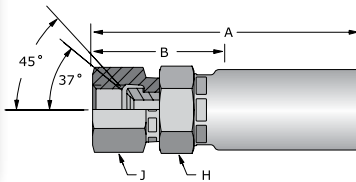

Part Number	Thread Size	Hose I.D.		A		Cutoff Allow. B		H Hex	J Hex
		inch	mm	inch	mm	inch	mm	inch	inch
#									
106CY-2-2	Flare 5/16-24	1/8	3	1.52	39	15/16	24	7/16	7/16
106CY-3-2	Flare 3/8-24	1/8	3	1.55	39	1	25	1/2	1/2
106CY-4-2	Flare 7/16-20	1/8	3	1.58	40	1	25	7/16	9/16
106CY-4-3	Flare 7/16-20	3/16	5	1.98	50	1-1/16	27	9/16	9/16

Construction: Steel.
Add "C" for Stainless Steel.
NOTE: Sizes -4 incorporates a dual seat.

E Fittings Series CY

F Tooling, Equipment & Accessories

G General Technical

113CY Male Pipe Swivel*

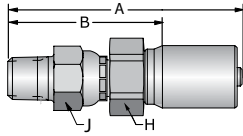

Part Number	Thread Size	Hose I.D.		A		Cutoff Allow. B		H Hex	J Hex
		inch	mm	inch	mm	inch	mm	inch	inch
#									
113CY-2-2	1/8-27	1/8	3	1.89	48	1-5/16	33	1/2	1/2
113CY-2-3	1/8-27	3/16	3	2.29	58	1-3/8	35	1/2	1/2

Construction: Steel.

Add "C" for Stainless Steel.

*NOTE: For use with petroleum based fluids.

WARNING: Fittings allow minor movement to relieve stress on hose but are not recommended for continued or extensive swiveling. Not recommended for use in CNG applications.

139CY Female JIC 37° Swivel 90° Elbow Short Drop

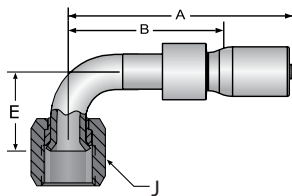

Part Number	Thread Size	Hose I.D.		A		Cutoff Allow. B		E		J Hex
		inch	mm	inch	mm	inch	mm	inch	mm	inch
#										
139CY-4-2	7/16-20	1/8	3	1.61	41	1-1/8	29	0.83	21	9/16
139CY-4-3	7/16-20	3/16	5	1.90	48	1	25	0.83	21	9/16

Construction: Steel.

Add "C" for Stainless Steel.

1GKCY Bulkhead with Integrated Zerk Port

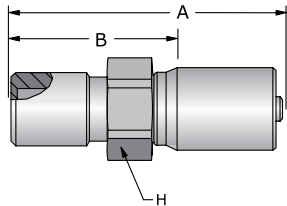

Part Number	Thread Size	Hose I.D.		A		Cutoff Allow. B		H Hex
		inch	mm	inch	mm	inch	mm	inch
#								
1GKCY-2-2	1/8-27 NPSM Male w/1/4-28 UNF Female	1/8	3	1.45	37	7/8	22	1/2
1GKCY-2-3	1/8-27 NPSM Male w/1/4-28 UNF Female	3/16	5	1.86	47	15/16	24	1/2
1GKCY-2-2-L77*	1/8-27 NPSM Male w/1/4-28 UNF Female	1/8	3	1.71	43	1-1/4	32	1/2
1GK91N-2-4**	1/8-27 NPSM Male w/1/4-28 UNF Female	3/16	5	1.46	37	15/16	24	1/2

Construction: Steel.

Add "C" for Stainless Steel.

NOTE: *Long bulkhead for use with plates under 3/4" thick. Uses 2GK-NUT, sold separately.

**Use with 919 hoses.

A Hose
 B Tubing
 C Coiled Air Hose & Fittings
 D Transportation
 E Fittings Series CY
 F Tooling, Equipment & Accessories
 G General Technical

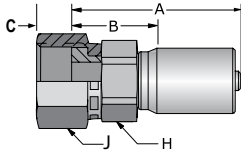
A
Hose**1JCCY Female Seal-Lok™ Swivel Straight Short**

Part Number	Thread Size	Hose I.D.		A		Cutoff Allow. B		C		H Hex	J Hex
		inch	mm	inch	mm	inch	mm	inch	mm	inch	inch
#											
1JCCY-4-2	9/16-18	1/8	3	1.29	33	3/4	19	.32	8	9/16	11/16

Construction: Steel.

Add "C" for Stainless Steel.

NOTE: When measuring overall length to the end of the nut, B+C dimensions must be used to calculate cut-off allowance. Stainless steel fittings must be assembled with Karrykrimp2 or Parkimp2. See CrimpSource for more information.

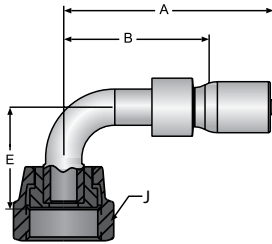
B
TubingC
Coiled Air Hose
& Fittings**1J9CY Female O-ring Face Seal Swivel Short Drop**

Part Number	Thread Size	Hose I.D.		A		Cutoff Allow. B		E		J Hex
		inch	mm	inch	mm	inch	mm	inch	mm	inch
#										
1J9CY-4-2	9/16-18	1/8	3	1.81	46	1-1/4	32	.83	21	11/16

Construction: Steel.

Add "C" for Stainless Steel.

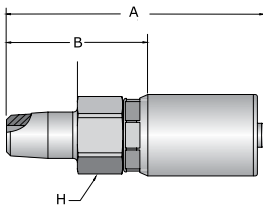
D
TransportationE
Fittings
Series CY**1LMCY Male Grease**

Part Number	Thread Size	Hose I.D.		A		Cutoff Allow. B		H Hex
		inch	mm	inch	mm	inch	mm	inch
#								
1LMCY-2-2	1/4-28	1/8	3	1.26	32	11/16	17	3/8

Construction: Steel.

Add "C" for Stainless Steel.

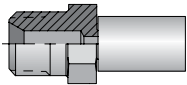
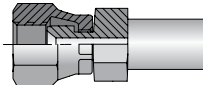
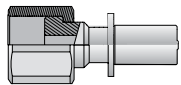
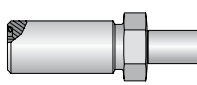

F
Tooling, Equipment
& AccessoriesG
General Technical

SF Series Visual Index

SF Series PERMANENT	101	Male Taper Pipe Rigid	106	JIC 37° Swivel	1JS	Female Seal-Lok™ Swivel Long	1JB	Male Seal-Lok™ Bulkhead w/O-ring
	 E-105		 E-105		 E-106		 E-106	

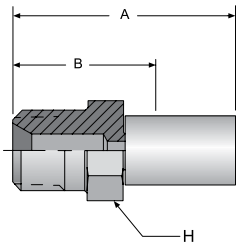
101SF Male Taper Pipe Rigid





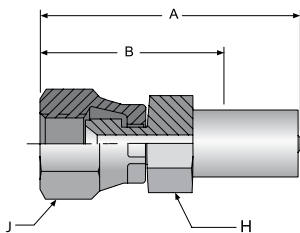

Part Number	Thread Size	Hose I.D.		A		Cutoff Allow. B		H Hex
		inch	mm	inch	mm	inch	mm	inch
#								
101SF-2-1	1/8-27	.090	2.3	1.13	29	3/4	19	7/16

Construction: Steel

106SF JIC 37° Swivel



Part Number	Thread Size	Hose I.D.		A		Cutoff Allow. B		H Hex	J Hex
		inch	mm	inch	mm	inch	mm	inch	inch
#									
106SF-2-1	5/16-24	.090	2.3	1.37	35	15/16	24	7/16	1/2

Construction: Steel

For detailed ordering information, please consult price list or contact Parflex® Division.

Parker Hannifin Corporation | Parflex® Division | Ravenna, Ohio | parker.com/pfd

www.comoso.com



E-105

A Hose
 B Tubing
 C Coiled Air Hose & Fittings
 D Transportation
 E Fittings Series SF
 F Tooling, Equipment & Accessories
 G General Technical

A
Hose

1JSSF Female Seal-Lok™ Swivel Long

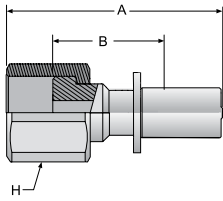

Part Number	Thread Size	Hose I.D.		A		Cutoff Allow. B		H Hex
		inch	mm	inch	mm	inch	mm	inch
#								
1JSSF-4-1	9/16-18	.090	2.3	1.50	88	3/4	19	11/16

Construction: Steel

B
Tubing

C
Coiled Air Hose & Fittings

D
Transportation

1JBSF Male Seal-Lok™ Bulkhead with O-ring

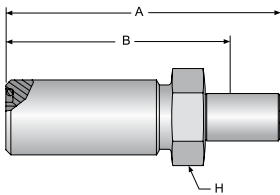

Part Number	Thread Size	Hose I.D.		A		Cutoff Allow. B		H Hex
		inch	mm	inch	mm	inch	mm	inch
#								
1JBSF-4-1	9/16-18	.090	2.3	2.06	52	1-11/16	43	5/8

Construction: Steel

NOTE: Bulkhead Locknut sold separately.





WLNL Locknuts are manufactured by the Tube Fittings Division. Refer to Catalog 4300 for additional information.

E
Fittings Series SF

F
Tooling, Equipment & Accessories

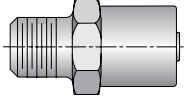
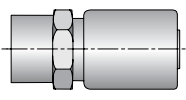
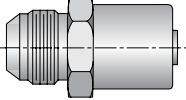
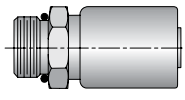
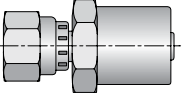
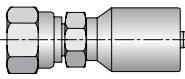
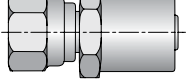
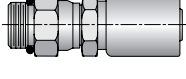
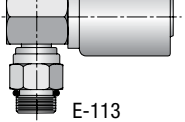
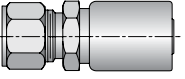
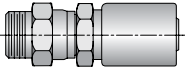
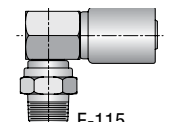
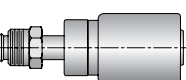
G
General Technical

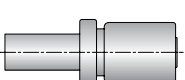
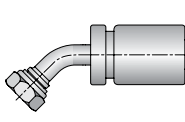
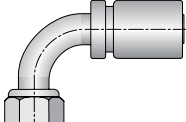
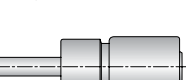
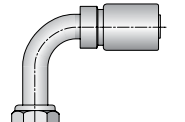
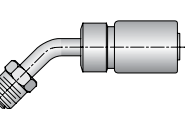
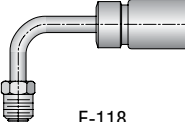
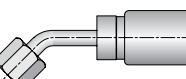
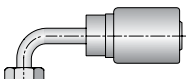
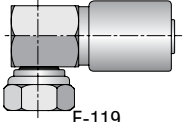
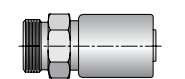
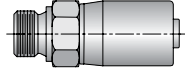
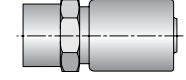
HY Series Visual Index

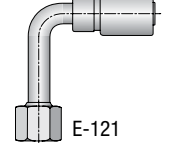
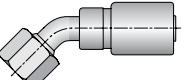
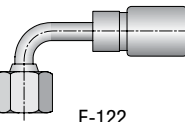
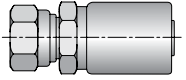
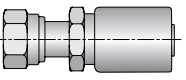
HY Series PERMANENT	101 Male NPTF Pipe Rigid  E-108	102 Female NPTF Pipe Rigid  E-109	103 Male (JIC) 37°  E-109	105 Male SAE Str. Thread Rigid w/O-ring  E-110	106 SAE (JIC) 37° Swivel  E-111
	107 Female NPSM Pipe Swivel (60° cone)  E-112	108 Female SAE 45° Swivel  E-112	10G Male SAE Str. Thread Swivel w/O-ring  E-113	10L Male SAE Str. Thread Swivel 90° Elbow  E-113	111 Male Ferulok Flare-less Rigid  E-114
	113 Male NPTF Pipe Swivel  E-114	11L Male NPTF Pipe Swivel 90° Elbow  E-115	128 Male Inverted SAE 45° Swivel  E-115	129 Male Inverted SAE 90° Swivel  E-116	134 Male Standpipe Rigid  E-116
	137 FM SAE (JIC) 37° Swivel 45° Elbow  E-116	139 FM SAE (JIC) 37° Swivel 90° Elbow  E-117	13D Male Standpipe Metric S Rigid  E-120	141 JIC 37° Swivel 90° Elbow Long  E-117	167 SAE Male Inverted 45° Elbow  E-118
	169 SAE Male Inverted 90° Elbow  E-118	177 SAE 45° Swivel 45° Elbow  E-118	179 SAE 45° Swivel 90° Elbow  E-119	193 Female (JIC) 37° Swivel 90° Elbow BT  E-119	1D0 Male Metric L Rigid  E-119
	1D9 Male BSPP  E-120	1GJ Female Grease Connection - SPL  E-120	1J0 Male Seal-Lok™ Rigid Str. w/O-ring  E-123	1J1 Seal-Lok™ 90° Elbow Long  E-121	1J7 Seal-Lok™ 45° Elbow  E-121
	1J9 Seal-Lok™ 90° Elbow  E-122	1JC Seal-Lok™ Swivel Short  E-122	1JS Seal-Lok™ Swivel Long  E-123		

For detailed ordering information, please consult price list or contact Parflex® Division.



A Hose
 B Tubing
 C Coiled Air Hose & Fittings
 D Transportation
 E Fittings Series HY
 F Tooling, Equipment & Accessories
 G General Technical

A Hose

101HY Male NPTF Pipe Rigid

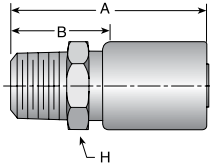

B Tubing

C Coiled Air Hose & Fittings

D Transportation

E Fittings Series HY

F Tooling, Equipment & Accessories

G General Technical

Part Number	Thread Size	Hose I.D.		A		Cutoff Allow. B		H Hex
		inch	mm	inch	mm	inch	mm	inch
#								
101HY-2-4	1/8x27	1/4	6	2.34	59	1.00	25	5/8
101HY-4-4	1/4x18	1/4	6	2.53	64	1.19	30	9/16
101HY-4-5	1/4x18	5/16	8	2.56	65	1.22	31	11/16
101HY-4-6	1/4x18	3/8	10	2.55	65	1.19	30	11/16
101HY-6-4	3/8x18	1/4	6	2.53	64	1.19	30	3/4
101HY-6-5	3/8x18	5/16	8	2.56	65	1.22	31	3/4
101HY-6-6	3/8x18	3/8	10	2.55	65	1.19	30	3/4
101HY-6-8	3/8x18	1/2	13	2.72	69	1.38	35	7/8
101HY-8-4	1/2x14	1/4	6	2.72	69	1.38	35	7/8
101HY-8-6	1/2x14	3/8	10	2.73	69	1.38	35	7/8
101HY-8-7	1/2x14	13/32	10	2.73	69	1.38	35	7/8
101HY-8-8	1/2x14	1/2	13	2.91	74	1.41	40	7/8
101HY-8-10	1/2x14	5/8	16	2.94	75	1.59	40	1-1/8
101HY-8-12	1/2x14	3/4	19	3.08	78	1.50	38	1-1/4
101HY-12-8	3/4x14	1/2	13	2.91	74	1.56	40	1-1/16
101HY-12-10	3/4x14	5/8	16	2.98	76	1.59	40	1-1/8
101HY-12-12	3/4x14	3/4	19	3.08	78	1.50	38	1-1/4
101HY-12-16	3/4x14	1	25	3.23	82	1.63	41	1-3/8
101HY-16-12	1x11-1/2	3/4	19	3.27	83	1.69	43	1-3/8
101HY-16-14	1x11-1/2	7/8	22	3.27	83	1.78	43	1-3/8
101HY-16-16	1x11-1/2	1	25	3.42	87	1.81	46	1-3/8
101HY-20-20	1-1/4x11-1/2	1-1/4	32	3.84	98	2.00	51	1-3/4

Construction: Steel

Add "C" for Stainless Steel.

NOTE: Stainless steel fittings must be assembled with Karrykrimp 2 or Parkrimp 2. See CrimpSource for more information.



For detailed ordering information, please consult price list or contact Parflex® Division.

Parker Hannifin Corporation | Parflex® Division | Ravenna, Ohio | parker.com/pfd

www.comoso.com

102HY Female NPTF Pipe Rigid

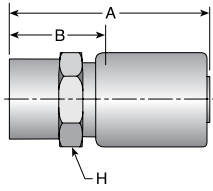

Part Number	Thread Size	Hose I.D.		A		Cutoff Allow. B		H Hex
		inch	mm	inch	mm	inch	mm	inch
#								
102HY-2-4	1/8x27	1/4	6	2.34	59	1.00	25	5/8
102HY-4-4	1/4x18	1/4	6	2.47	63	1.13	29	11/16
102HY-4-6	1/4x18	3/8	10	2.48	63	1.13	29	11/16
102HY-6-4	3/8x18	1/4	6	2.47	63	1.13	29	7/8
102HY-6-6	3/8x18	3/8	10	2.48	63	1.13	29	7/8
102HY-8-6	1/2x14	3/8	10	2.75	70	1.41	36	1
102HY-8-8	1/2x14	1/2	13	2.84	72	1.50	38	1
102HY-12-12	3/4x14	3/4	19	2.83	72	1.25	32	1-1/4
102HY-16-16	1x11-1/2	1	25	3.27	83	1.66	42	1-1/2

Construction: Steel

103HY Male JIC 37° Rigid

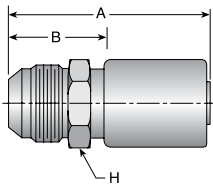

Part Number	Thread Size	Hose I.D.		A		Cutoff Allow. B		H Hex
		inch	mm	inch	mm	inch	mm	inch
#								
103HY-4-4	7/16x20	1/4	6	2.52	64	1.19	30	5/8
103HY-5-4	1/2x20	1/4	6	2.52	64	1.19	30	5/8
103HY-6-4	9/16x18	1/4	6	2.53	64	1.19	30	11/16
103HY-6-5	9/16x18	5/16	8	2.56	65	1.22	31	11/16
103HY-6-6	9/16x18	3/8	10	2.54	65	1.19	30	11/16
103HY-6-8	9/16x18	1/2	13	2.72	69	1.38	35	7/8
103HY-8-6	3/4x16	3/8	10	2.64	67	1.28	33	13/16
103HY-8-8	3/4x16	1/2	13	2.81	71	1.47	37	7/8
103HY-10-6	7/8x14	3/8	10	2.81	71	1.47	37	1
103HY-10-8	7/8x14	1/2	13	2.91	74	1.56	40	1
103HY-10-10	7/8x14	5/8	16	2.98	76	1.59	40	1-1/8
103HY-10-12	7/8x14	3/4	19	3.08	78	1.50	38	1-1/4
103HY-12-8	1-1/16x12	1/2	13	3.02	77	1.66	42	1-1/8
103HY-12-10	1-1/16x12	5/8	16	3.09	78	1.72	44	1-1/8
103HY-12-12	1-1/16x12	3/4	19	3.19	81	1.63	41	1-1/4
103HY-14-12	1-3/16x12	3/4	19	3.19	81	1.63	41	1-1/4
103HY-16-12	1-5/16x12	3/4	19	3.23	82	1.66	42	1-3/8
103HY-16-16	1-5/16x12	1	25	3.39	86	1.78	45	1-3/8
103HY-20-16	1-5/8x12	1	25	3.44	87	1.81	46	1-3/4
103HY-20-20	1-5/8x12	1-1/4	32	3.83	97	2.00	51	1-3/4

Construction: Steel

For detailed ordering information, please consult price list or contact Parflex® Division.

Parker Hannifin Corporation | Parflex® Division | Ravenna, Ohio | parker.com/pfd

www.comoso.com



A Hose
 B Tubing
 C Coiled Air Hose & Fittings
 D Transportation
 E Fittings Series HY
 F Tooling, Equipment & Accessories
 G General Technical

A
Hose

105HY Male SAE Straight Thread Rigid (with O-ring)

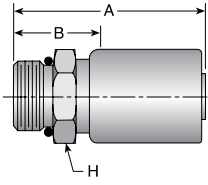

Part Number	Thread Size	Hose I.D.		A		Cutoff Allow. B		H Hex
		inch	mm	inch	mm	inch	mm	inch
#								
105HY-4-4	7/16x20	1/4	6	2.33	59	0.97	25	9/16
105HY-5-4	1/2x20	1/4	6	2.33	59	0.97	25	5/8
105HY-6-4	9/16x18	1/4	6	2.42	61	1.06	27	11/16
105HY-6-6	9/16x18	3/8	10	2.38	60	1.03	26	11/16
105HY-8-6	3/4x16	3/8	10	2.42	61	1.06	27	7/8
105HY-8-8	3/4x16	1/2	13	2.59	66	1.25	32	7/8
105HY-10-6	7/8x14	3/8	10	2.55	65	1.19	30	1
105HY-10-8	7/8x14	1/2	13	2.66	68	1.31	33	1
105HY-10-10	7/8x14	5/8	16	2.80	71	1.41	36	1-1/8
105HY-12-8	1-1/16x12	1/2	13	2.81	71	1.47	37	1-1/4
105HY-12-10	1-1/16x12	5/8	16	2.83	72	1.44	37	1-1/4
105HY-12-12	1-1/16x12	3/4	19	2.92	74	1.34	34	1-1/4
105HY-16-12	1-5/16x12	3/4	19	2.92	74	1.34	34	1-1/2
105HY-16-16	1-5/16x12	1	25	3.08	78	1.47	37	1-1/2

Construction: Steel

NOTE: O-ring not compatible with Phosphate Ester fluids.

B
Tubing

C
Coiled Air Hose
& Fittings

D
Transportation

E
Fittings
Series HY

F
Tooling, Equipment
& Accessories

G
General Technical

106HY Female JIC 37°Swivel

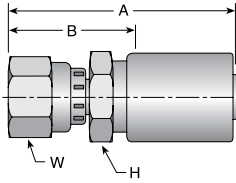

Part Number	Thread Size	Hose I.D.		A		Cutoff Allow. B		H Hex	W Hex
		inch	mm	inch	mm	inch	mm	inch	inch
#									
106HY-3-4	3/8x24	1/4	6	2.58	66	1.22	31	9/16	1/2
106HY-4-4	7/16x20	1/4	6	2.60	66	1.25	32	9/16	9/16
106HY-4-6	7/16x20	3/8	10	2.67	68	1.31	33	3/4	9/16
106HY-5-4	1/2x20	1/4	6	2.65	67	1.31	33	9/16	5/8
106HY-5-5	1/2x20	5/16	8	2.69	68	1.34	34	5/8	5/8
106HY-5-6	1/2x20	3/8	10	2.73	69	1.38	35	3/4	5/8
106HY-6-4	9/16x18	1/4	6	2.67	68	1.31	33	9/16	11/16
106HY-6-5	9/16x18	5/16	8	2.70	69	1.34	34	5/8	11/16
106HY-6-6	9/16x18	3/8	10	2.69	68	1.34	34	11/16	11/16
106HY-8-6	3/4x16	3/8	10	2.72	69	1.38	35	7/8	7/8
106HY-8-8	3/4x16	1/2	13	2.90	74	1.41	40	7/8	7/8
106HY-8-10	3/4x16	5/8	16	2.98	76	1.59	40	1-1/8	7/8
106HY-8-12	3/4x16	3/4	19	3.08	78	1.53	39	1-1/4	7/8
106HY-10-6	7/8x14	3/8	10	2.81	71	1.47	37	7/8	1
106HY-10-8	7/8x14	1/2	13	2.98	76	1.63	41	1	1
106HY-10-10	7/8x14	5/8	16	3.06	78	1.69	43	1-1/8	1
106HY-10-12	7/8x14	3/4	19	3.16	80	1.59	40	1-1/4	1
106HY-12-6	1-1/16x12	3/8	10	3.00	76	1.66	42	1-1/8	1-1/4
106HY-12-8	1-1/16x12	1/2	13	3.05	77	1.69	43	1-1/8	1-1/4
106HY-12-10	1-1/16x12	5/8	16	3.12	79	1.75	44	1-1/8	1-1/4
106HY-12-12	1-1/16x12	3/4	19	3.22	82	1.66	42	1-1/4	1-1/4
106HY-12-16	1-1/16x12	1	25	3.38	86	1.75	44	1-3/8	1-1/4
106HY-14-12	1-3/16x12	3/4	19	3.23	82	1.66	42	1-1/4	1 3/8
106HY-16-12	1-5/16x12	3/4	19	3.30	84	1.72	44	1-3/8	1-1/2
106HY-16-14	1-5/16x12	7/8	22	3.30	84	1.72	44	1-3/8	1-1/2
106HY-16-16	1-5/16x12	1	25	3.45	88	1.84	47	1-3/8	1-1/2
106HY-16-20	1-5/16x12	1-1/4	32	3.84	98	2.00	51	1-3/4	1-1/2
106HY-20-16	1-5/8x12	1	25	3.70	94	2.09	53	1-3/4	2
106HY-20-20	1-5/8x12	1-1/4	32	4.09	104	2.25	57	2	2

Construction: Steel

For detailed ordering information, please consult price list or contact Parflex® Division.

Parker Hannifin Corporation | Parflex® Division | Ravenna, Ohio | parker.com/pfd

www.comoso.com



A Hose
B Tubing
C Coiled Air Hose & Fittings
D Transportation
E Fittings Series HY
F Tooling, Equipment & Accessories
G General Technical

A
Hose

107HY Female NPSM Pipe Swivel (60° Cone)

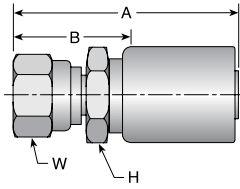

Part Number	Thread Size	Hose I.D.		A		Cutoff Allow. B		H Hex	W Hex
		inch	mm	inch	mm	inch	mm	inch	inch
#									
107HY-4-4	1/4x18	1/4	6	2.66	68	1.31	33	9/16	11/16
107HY-6-4	3/8x18	1/4	6	2.72	69	1.38	35	3/4	7/8
107HY-6-6	3/8x18	3/8	10	2.55	65	1.19	30	3/4	7/8
107HY-8-8	1/2x14	1/2	13	2.91	74	1.56	40	1	1
107HY-12-8	3/4x14	1/2	13	3.05	77	1.69	43	1-1/4	1-1/4
107HY-12-12	3/4x14	3/4	19	3.22	82	1.66	42	1-1/4	1-1/4
107HY-16-16	1x11-1/2	1	25	3.39	86	1.78	45	1-3/8	1-1/2

Construction: Steel

B
Tubing

C
Coiled Air Hose & Fittings

D
Transportation

108HY Female SAE 45° Swivel

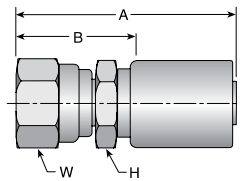

Part Number	Thread Size	Hose I.D.		A		Cutoff Allow. B		H Hex	W Hex
		inch	mm	inch	mm	inch	mm	inch	inch
#									
108HY-4-4	7/16x20	1/4	6	2.60	66	1.26	32	9/16	9/16
108HY-5-4	1/2x20	1/4	6	2.66	68	1.31	33	9/16	5/8
108HY-5-5	1/2x20	5/16	8	2.68	68	1.34	34	5/8	5/8
108HY-6-4	5/8x18	1/4	6	2.73	69	1.38	35	11/16	3/4
108HY-6-5	5/8x18	5/16	8	2.76	70	1.41	36	5/8	3/4
108HY-6-6	5/8x18	3/8	10	2.75	70	1.41	36	11/16	3/4
108HY-8-6	3/4x16	3/8	10	2.73	69	1.38	35	13/16	7/8
108HY-8-8	3/4x16	1/2	13	2.90	74	1.56	40	7/8	7/8
108HY-8-12	3/4x16	3/4	19	3.17	81	1.59	40	1-1/4	7/8
108HY-10-8	7/8x14	1/2	13	2.98	76	1.63	41	1	1
108HY-10-10	7/8x14	5/8	16	3.06	78	1.69	43	1-1/8	1
108HY-12-10	1-1/16x12	5/8	16	3.33	85	1.94	49	1-1/8	1-1/4
108HY-12-12	1-1/16x12	3/4	19	3.41	87	1.84	47	1-1/4	1-1/4

Construction: Steel

E
Fittings Series HY

F
Tooling, Equipment & Accessories

G
General Technical

10GHY Male SAE Straight Thread Swivel (with O-ring)

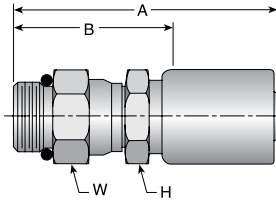

Part Number	Thread Size	Hose I.D.		A		Cutoff Allow. B		H Hex	W Hex
		inch	mm	inch	mm	inch	mm	inch	inch
#									
10GHY-4-4*	7/16x20	1/4	6	3.00	76	1.66	42	9/16	5/8
10GHY-5-4*	1/2x20	1/4	6	3.00	76	1.66	42	9/16	5/8
10GHY-6-4	9/16x18	1/4	6	3.16	80	1.81	46	5/8	11/16
10GHY-6-6	9/16x18	3/8	10	3.14	80	1.78	45	11/16	11/16
10GHY-8-6	3/4x16	3/8	10	3.24	82	1.88	48	13/16	7/8
10GHY-8-8	3/4x16	1/2	13	3.36	85	2.00	51	7/8	7/8
10GHY-10-8	7/8x14	1/2	13	3.44	87	2.09	53	1	1
10GHY-12-8	1-1/16x12	1/2	13	3.66	93	2.31	59	1-1/4	1-1/4
10GHY-12-12	1-1/16x12	3/4	19	3.89	99	2.31	59	1-1/4	1-1/4
10GHY-16-16	1-5/16x12	1	25	3.95	100	2.34	59	1-3/8	1-1/2

Construction: Steel

NOTE: Fitting allows minor movement under pressure to relieve stress on hose but is not to be used on extensive or continuous swiveling. O-ring not compatible with Phosphate Ester fluids.

10LHY Male SAE Straight Thread Swivel 90° Elbow (with O-ring)

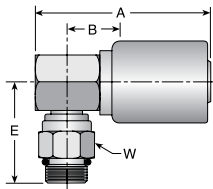

Part Number	Thread Size	Hose I.D.		A		Cutoff Allow. B		E		W Hex
		inch	mm	inch	mm	inch	mm	inch	mm	inch
#										
10LHY-4-4	7/16x20	1/4	6	2.31	59	0.97	25	1.63	41	11/16
10LHY-6-4	9/16x18	1/4	6	2.31	59	0.97	25	1.66	42	7/8
10LHY-6-6	9/16x18	3/8	10	2.33	59	0.97	25	1.66	42	11/16
10LHY-8-4	3/4x16	1/4	6	2.31	59	0.94	24	1.75	44	7/8
10LHY-8-6	3/4x16	3/8	10	2.33	59	0.97	25	1.73	44	7/8
10LHY-8-8	3/4x16	1/2	13	3.00	76	1.09	28	1.80	46	7/8
10LHY-10-8	7/8x14	1/2	13	3.00	76	1.09	28	1.88	48	1
10LHY-12-12	1-1/16x12	3/4	19	2.77	70	1.19	30	2.23	57	1-1/4

Construction: Steel

NOTE: Fitting allows minor movement under pressure to relieve stress on hose but is not to be used on extensive or continuous swiveling.

A Hose
B Tubing
C Coiled Air Hose & Fittings
D Transportation
E Fittings Series HY
F Tooling, Equipment & Accessories
G General Technical

A Hose

111HY Male Ferulok Flareless Rigid (24° Cone w/Nut and Ferrule)

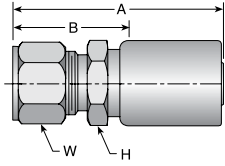

Part Number	Thread Size	Hose I.D.		A		Cutoff Allow. B		H Hex	W Hex
		inch	mm	inch	mm	inch	mm	inch	inch
#									
111HY-4-4	7/16x20	1/4	6	2.42	61	1.06	27	9/16	9/16
111HY-4-6	7/16x20	3/8	10	2.44	62	1.09	28	3/4	9/16
111HY-5-6	1/2x20	3/8	10	2.44	62	1.09	28	3/4	5/8
111HY-6-4	9/16x18	1/4	6	2.44	62	1.09	28	5/8	11/16
111HY-6-6	9/16x18	3/8	10	2.45	62	1.09	28	11/16	11/16
111HY-8-6	3/4x16	3/8	10	2.61	66	1.25	32	7/8	7/8
111HY-8-8	3/4x16	1/2	13	2.72	69	1.38	35	7/8	7/8
111HY-10-8	7/8x14	1/2	13	2.78	71	1.44	37	1	1
111HY-12-12	1-1/16x12	3/4	19	3.02	77	1.44	37	1-1/4	1-1/4

Construction: Steel

NOTE: The Parker Ferrule-Fix fitting makes it possible to salvage the bent tube section from a hose assembly for quick, easy on the job repairs. See page G-41 for Ferrule-Fix installation instructions.

B Tubing

C Coiled Air Hose & Fittings

D Transportation

113HY Male NPTF Pipe Swivel

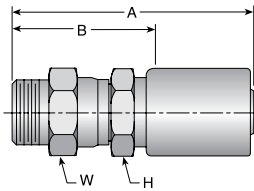

Part Number	Thread Size	Hose I.D.		A		Cutoff Allow. B		H Hex	W Hex
		inch	mm	inch	mm	inch	mm	inch	inch
#									
113HY-2-4	1/8x27	1/4	6	2.97	75	1.63	41	9/16	5/8
113HY-4-4	1/4x18	1/4	6	3.06	78	1.72	44	9/16	5/8
113HY-4-6	1/4x18	3/8	10	3.17	81	1.81	46	11/16	11/16
113HY-6-4	3/8x18	1/4	6	3.13	80	1.78	45	5/8	11/16
113HY-6-6	3/8x18	3/8	10	3.11	79	1.75	44	11/16	11/16
113HY-6-8	3/8x18	1/2	13	3.31	84	1.97	50	7/8	7/8
113HY-8-6	1/2x14	3/8	10	3.38	86	2.03	52	7/8	7/8
113HY-8-8	1/2x14	1/2	13	3.50	89	2.16	55	7/8	7/8
113HY-12-12*	3/4x14	3/4	25	3.95	100	2.38	60	1-1/4	1-1/4
113HY-16-16*	1x11-1/2	1	25	4.23	107	2.63	67	1-1/2	1-1/2

Construction: Steel

NOTE: Fitting allows minor movement under pressure to relieve stress on hose but is not to be used for continuous swiveling. See Hose Products Catalog 4400 for pressure limitations.

E Fittings Series HY

F Tooling, Equipment & Accessories

G General Technical



11LHY Male NPTF Pipe Swivel 90° Elbow

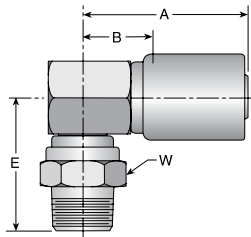

Part Number	Thread Size	Hose I.D.		A		Cutoff Allow. B		E		W Hex
		inch	mm	inch	mm	inch	mm	inch	mm	inch
#										
11LHY-2-4	1/8x27	1/4	6	2.31	59	0.97	25	1.50	38	5/8
11LHY-4-4	1/4x18	1/4	6	2.31	59	0.97	25	1.69	43	11/16
11LHY-4-6	1/4x18	3/8	10	2.33	59	0.97	25	1.69	43	11/16
11LHY-6-4	3/8x18	1/4	6	2.31	59	0.97	25	1.63	41	11/16
11LHY-6-6	3/8x8	3/8	10	2.33	59	0.97	25	1.63	41	11/16
11LHY-8-6	1/2x14	3/8	10	2.73	69	0.97	25	1.88	48	7/8
11LHY-8-8	1/2x14	1/2	13	3.00	76	1.09	28	1.93	49	7/8

Construction: Steel

128HY Male Inverted SAE 45° Swivel

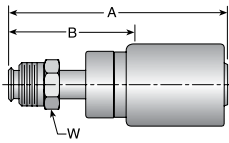

Part Number	Thread Size	Hose I.D.		A		Cutoff Allow. B		W Hex
		inch	mm	inch	mm	inch	mm	inch
#								
128HY-3-4	3/8x24	1/4	6	3.09	78	1.75	44	3/8
128HY-4-4	7/16x24	1/4	6	3.28	83	1.94	49	7/16
128HY-5-4	1/2x20	1/4	6	3.34	85	2.00	51	1/2
128HY-5-6	1/2x20	3/8	10	3.17	81	1.81	46	1/2
128HY-6-5	5/8x18	5/16	8	3.75	95	2.41	61	5/8
128HY-6-6	5/8x18	3/8	10	3.73	95	2.38	60	5/8
128HY-7-6	1 1/16x18	3/8	10	3.73	95	2.38	60	11/16
128HY-8-6	3/4x18	3/8	10	3.42	87	2.06	52	3/4
128HY-8-8	3/4x18	1/2	13	3.66	93	2.31	59	3/4

Construction: Steel

For detailed ordering information, please consult price list or contact Parflex® Division.



A Hose
 B Tubing
 C Coiled Air Hose & Fittings
 D Transportation
 E Fittings Series HY
 F Tooling, Equipment & Accessories
 G General Technical

A Hose

129HY Female Inverted SAE 45° Rigid

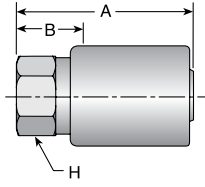

Part Number	Thread Size	Hose I.D.		A		Cutoff Allow. B		H Hex
		inch	mm	inch	mm	inch	mm	inch
#								
129HY-5-4	1/2x20	1/4	6	2.25	57	0.91	23	5/8
129HY-6-6	5/8x18	3/8	10	2.25	57	0.91	23	7/8

Construction: Steel

B Tubing

134HY Male Standpipe Rigid (Inch Size Tube O.D.)

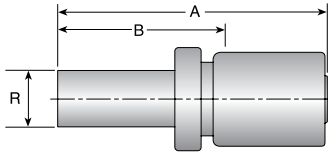

Part Number	Diameter R		Hose I.D.		A		Cutoff Allow. B	
	inch	mm	inch	mm	inch	mm	inch	mm
#								
134HY-6-6	3/8	10	3/8	10	3.17	81	1.81	46
134HY-8-6	1/2	13	3/8	10	3.33	85	1.97	50
134HY-12-12	3/4	19	3/4	19	3.89	99	2.31	59

Construction: Steel

C Coiled Air Hose & Fittings

D Transportation

137HY Female JIC 37° Swivel 45° Elbow Short Drop

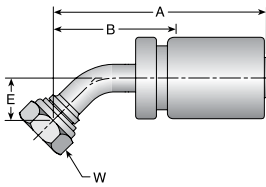

Part Number	Thread Size	Hose I.D.		A		Cutoff Allow. B		E		W Hex
		inch	mm	inch	mm	inch	mm	inch	mm	inch
#										
137HY-4-4	7/16x20	1/4	6	2.59	66	1.32	34	0.39	10	9/16
137HY-5-4	1/2x20	1/4	6	3.27	83	1.91	49	0.36	9	5/8
137HY-6-4	9/16x18	1/4	6	2.70	69	1.43	36	0.43	10	3/4
137HY-6-5	9/16x18	5/16	8	3.34	85	2.00	51	0.39	11	11/16
137HY-6-6	9/16x18	3/8	10	2.72	69	1.44	37	0.43	11	11/16
137HY-8-6	3/4x16	3/8	10	2.88	73	1.60	41	0.58	15	7/8
137HY-8-8	3/4x16	1/2	13	3.10	79	1.81	46	0.59	15	7/8
137HY-10-8	7/8x14	1/2	13	3.20	81	1.91	49	0.63	16	1
137HY-10-10	7/8x14	5/8	16	3.29	84	1.93	49	0.63	16	1
137HY-12-10	1-1/16x12	5/8	16	3.94	100	2.56	65	0.77	20	1-1/8
137HY-12-12	1-1/16x12	3/4	19	3.82	97	2.29	58	0.83	21	1-1/4
137HY-16-12	1-5/16x12	3/4	19	4.35	110	2.78	71	0.89	23	1-1/2
137HY-16-16	1-5/16x12	1	25	4.31	109	2.69	68	0.89	23	1-1/2

Construction: Steel

E Fittings Series HY

F Tooling, Equipment & Accessories

G General Technical



139HY Female JIC 37° Swivel 90° Elbow Short Drop

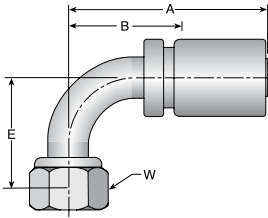

Part Number	Thread Size	Hose I.D.		A		Cutoff Allow. B		E		W Hex
		inch	mm	inch	mm	inch	mm	inch	mm	inch
#										
139HY-4-4	7/16x20	1/4	6	2.40	61	1.13	29	0.83	21	9/16
139HY-5-4	1/2x20	1/4	6	2.50	64	1.23	31	0.83	21	5/8
139HY-6-4	9/16x18	1/4	6	2.65	67	1.38	35	0.91	23	3/4
139HY-6-5	9/16x18	5/16	8	3.25	83	1.91	49	0.86	22	11/16
139HY-6-6	9/16x18	3/8	10	2.57	65	1.29	33	0.91	23	11/16
139HY-6-8	9/16x18	1/2	13	3.41	87	2.06	52	0.86	22	11/16
139HY-8-6	3/4x16	3/8	10	2.64	67	1.37	35	1.14	29	7/8
139HY-8-8	3/4x16	1/2	13	2.85	72	1.56	40	1.14	29	7/8
139HY-10-8	7/8x14	1/2	13	3.01	76	1.72	44	1.26	32	1
139HY-10-10	7/8x14	5/8	16	3.09	78	1.73	44	1.26	32	1
139HY-10-12	7/8x14	3/4	19	3.25	83	1.69	43	1.23	31	1
139HY-12-8	1-1/16x12	1/2	13	3.61	92	2.25	57	1.83	46	1-1/4
139HY-12-10	1-1/16x12	5/8	16	3.61	92	2.25	57	1.89	48	1-1/4
139HY-12-12	1-1/16x12	3/4	19	3.68	93	2.15	55	1.89	48	1-1/4
139HY-16-12	1-5/16x12	3/4	19	4.33	110	2.78	71	2.14	54	1-1/2
139HY-16-16	1-5/16x12	1	25	4.31	109	2.69	68	2.31	59	1-1/2

Construction: Steel

141HY Female JIC 37° Swivel 90° Elbow Long Drop

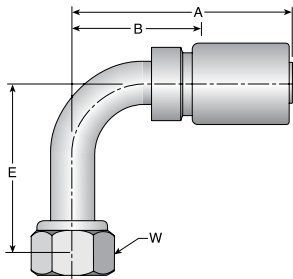

Part Number	Thread Size	Hose I.D.		A		Cutoff Allow. B		E		W Hex
		inch	mm	inch	mm	inch	mm	inch	mm	inch
#										
141HY-4-4	7/16x20	1/4	6	2.68	68	1.41	36	1.81	46	9/16
141HY-5-4	1/2x20	1/4	6	3.16	80	1.81	46	1.77	45	5/8
141HY-6-4	9/16x18	1/4	6	2.89	73	1.62	41	2.13	54	11/16
141HY-6-6	9/16x18	3/8	10	2.76	70	1.49	39	2.13	54	11/16
141HY-8-6	3/4x16	3/8	10	2.85	72	1.58	40	2.52	64	7/8
141HY-8-8	3/4x16	1/2	13	2.89	73	1.60	41	2.52	64	7/8
141HY-10-8	7/8x14	1/2	13	3.01	76	1.72	44	2.76	70	1
141HY-12-12	1-1/16x12	3/4	19	3.59	91	2.03	52	3.73	95	1-1/4
141HY-16-16	1-5/16x12	1	25	4.56	116	2.94	75	4.33	110	1-1/2

Construction: Steel

For detailed ordering information, please consult price list or contact Parflex® Division.

Parker Hannifin Corporation | Parflex® Division | Ravenna, Ohio | parker.com/pfd

www.comoso.com



E-117

A Hose
B Tubing
C Coiled Air Hose & Fittings
D Transportation
E Fittings Series HY
F Tooling, Equipment & Accessories
G General Technical

A Hose

167HY Male Inverted SAE 45° Swivel 45° Elbow

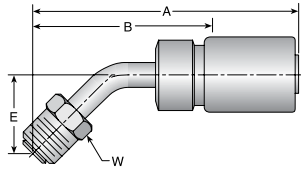

Part Number	Thread Size	Hose I.D.		A		Cutoff Allow. B		E		W Hex
		inch	mm	inch	mm	inch	mm	inch	mm	inch
#										
167HY-4-4	7/16x24	1/4	6	3.31	84	1.97	50	0.78	20	7/16
167HY-5-4	1/2x20	1/4	6	3.55	90	2.19	56	0.88	22	1/2
167HY-5-6	1/2x20	3/8	10	3.38	86	2.03	52	0.88	22	1/2
167HY-6-6	5/8x18	3/8	10	4.16	106	2.81	71	0.94	24	5/8
167HY-8-8	3/4x18	1/2	13	4.22	107	2.88	73	1.06	27	3/4

Construction: Steel

B Tubing

C Coiled Air Hose & Fittings

169HY Male Inverted SAE 45° Swivel 90° Elbow

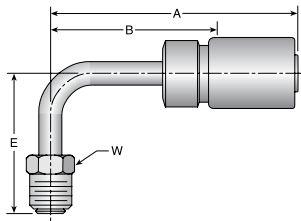

Part Number	Thread Size	Hose I.D.		A		Cutoff Allow. B		E		W Hex
		inch	mm	inch	mm	inch	mm	inch	mm	inch
#										
169HY-3-4	3/8x24	1/4	6	3.09	78	1.75	44	1.38	35	3/8
169HY-4-4	7/16x24	1/4	6	3.28	83	1.94	49	1.47	37	7/16
169HY-4-6	7/16x24	3/8	10	3.11	79	1.75	44	1.47	37	7/16
169HY-5-4	1/2x20	1/4	6	3.52	89	2.16	55	1.66	42	1/2
169HY-5-6	1/2x20	3/8	10	3.34	85	2.00	51	1.66	42	1/2
169HY-6-5	5/8x18	5/16	8	4.05	103	2.69	68	1.69	43	5/8
169HY-6-6	5/8x18	3/8	10	4.03	102	2.69	68	1.69	43	5/8
169HY-7-6	11/16x18	3/8	10	4.16	106	2.81	71	1.69	43	11/16
169HY-8-8	3/4x18	1/2	13	4.09	104	2.75	70	1.88	48	3/4

Construction: Steel

D Transportation

E Fittings Series HY

177HY Female SAE 45° Swivel 45° Elbow

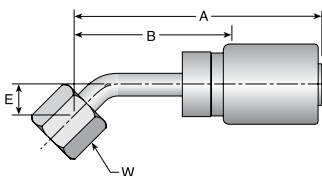

Part Number	Thread Size	Hose I.D.		A		Cutoff Allow. B		E		W Hex
		inch	mm	inch	mm	inch	mm	inch	mm	inch
#										
177HY-6-6	5/8x18	3/8	10	3.33	85	1.97	50	0.39	10	3/4
177HY-12-12	1-1/16x14	3/4	19	4.03	102	2.44	62	0.77	20	1-1/4

Construction: Steel

F Tooling, Equipment & Accessories

G General Technical

179HY Female SAE 45° Swivel 90° Elbow

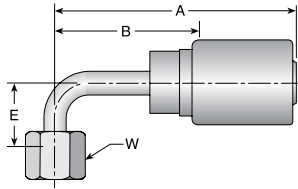

Part Number	Thread Size	Hose I.D.		A		Cutoff Allow. B		E		W Hex
		inch	mm	inch	mm	inch	mm	inch	mm	inch
#										
179HY-6-5	5/8x18	5/16	8	3.25	83	1.91	49	0.86	22	3/4
179HY-6-6	5/8x18	3/8	10	3.23	82	1.88	48	0.86	22	3/4
179HY-12-12	1-1/16x14	3/4	19	3.98	101	2.39	61	1.83	46	1-1/4

Construction: Steel

193HY Female JIC 37° Swivel 90° Elbow (Block Type)

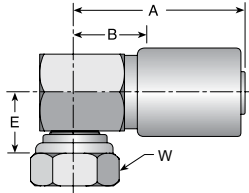

Part Number	Thread Size	Hose I.D.		A		Cutoff Allow. B		E		W Hex
		inch	mm	inch	mm	inch	mm	inch	mm	inch
#										
193HY-6-6	9/16x18	3/8	10	2.33	59	0.97	25	0.78	20	11/16
193HY-8-6	3/4x16	3/8	10	2.33	59	0.97	25	0.82	21	7/8
193HY-8-8	3/4x16	1/2	13	3.00	76	1.09	28	0.85	22	7/8
193HY-12-12	1-1/16x12	3/4	19	3.33	85	1.19	30	0.99	25	1-1/4

Construction: Steel

1D0HY Male Metric L Rigid (24° Cone) ISO 12151-2

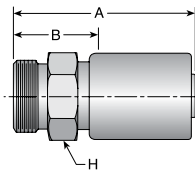

Part Number	Thread Size		Hose I.D.		A		Cutoff Allow. B		H Hex
	mm		inch	mm	inch	mm	inch	mm	inch
#									
1D0HY-6-4	6	M12x1.5	1/4	6	2.36	60	1.00	25	14
1D0HY-8-4	8	M14x1.5	1/4	6	2.36	60	1.00	25	17
1D0HY-10-4	10	M16x1.5	1/4	6	2.40	61	1.03	26	19
1D0HY-10-6	10	M16x1.5	3/8	10	2.42	61	1.06	27	19
1D0HY-12-6	12	M18x1.5	3/8	10	2.42	61	1.06	27	22
1D0HY-15-6	15	M22x1.5	3/8	10	2.52	64	1.16	29	24
1D0HY-15-8	15	M22x1.5	1/2	13	2.63	67	1.28	33	24
1D0HY-18-10	18	M26x1.5	5/8	16	2.71	69	1.31	33	27

Construction: Steel

For detailed ordering information, please consult price list or contact Parflex® Division.

Parker Hannifin Corporation | Parflex® Division | Ravenna, Ohio | parker.com/pfd

www.comoso.com



A Hose

B Tubing

C Coiled Air Hose & Fittings

D Transportation

E Fittings Series HY

F Tooling, Equipment & Accessories

G General Technical

A Hose

13DHY Male Standpipe Metric S Rigid End Connection per ISO 8434-1-SDS

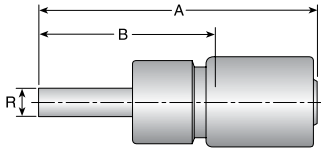

Part Number	Diameter R		Hose I.D.		A		Cutoff Allow. B	
	mm	inch	inch	mm	inch	mm	inch	mm
#	Ø		⊙					
13DHY-16-8	16	0.63	1/2	13	3.53	90	2.16	55
13DHY-30-16	30	1.18	1	25	4.15	105	2.53	64

Construction: Steel

B Tubing

C Coiled Air Hose & Fittings

1D9HY Male BSP Parallel Pipe Rigid (60° Cone) ISO 228-1

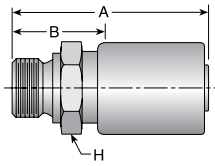

Part Number	Thread Size	Hose I.D.		A		Cutoff Allow. B		H Hex
		inch	mm	inch	mm	inch	mm	inch
#	⌀	⊙						⬡
1D9HY-4-4	1/4x19	1/4	6	2.40	61	1.03	26	13/16
1D9HY-6-6	3/8x19	3/8	10	2.55	65	1.19	30	7/8
1D9HY-8-6	1/2x14	3/8	10	2.65	67	1.28	33	1-1/16
1D9HY-8-8	1/2x14	1/2	13	2.83	72	1.47	37	1-1/16

Construction: Steel

NOTE: When used in a port, a bonded seal must be used.

D Transportation

E Fittings Series HY

1GJHY Female Grease Connection -SPL- PTF Taper Thread Rigid 1/2 x 27

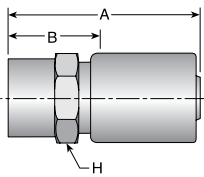

Part Number	Thread Size	Hose I.D.		A		Cutoff Allow. B		H Hex
		inch	mm	inch	mm	inch	mm	inch
#	⌀	⊙						⬡
1GJHY-8-4	1/2x27	1/4	6	2.41	61	1.06	27	3/4

Construction: Steel

F Tooling, Equipment & Accessories

G General Technical

1J1HY Female Seal-Lok™ Swivel 90° Elbow Long Drop ISO 12151-1 - SWEL90

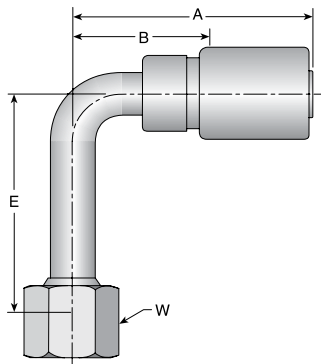

Part Number	Thread Size	Hose I.D.		A		Cutoff Allow. B		E		W Hex
		inch	mm	inch	mm	inch	mm	inch	mm	inch
#										
1J1HY-4-4	9/16x18	1/4	6	2.68	68	1.41	36	1.81	46	11/16
1J1HY-6-4	11/16x16	1/4	6	2.89	73	1.62	41	2.13	54	13/16
1J1HY-6-6	11/16x16	3/8	10	2.76	70	1.49	38	2.13	54	13/16
1J1HY-8-6	13/16x16	3/8	10	2.85	72	1.58	40	2.52	64	15/16
1J1HY-8-8	13/16x16	1/2	13	2.94	75	1.65	42	2.52	64	15/16
1J1HY-10-8	1x14	1/2	13	3.01	76	1.72	44	2.76	70	1-1/8
1J1HY-10-10	1x14	5/8	16	3.42	87	2.03	52	2.76	70	1-1/8
1J1HY-12-12	1-3/16x12	3/4	19	3.68	93	2.15	55	3.78	96	1-3/8
1J1HY-16-16	1-7/16x12	1	25	4.45	113	2.84	72	4.50	114	1-5/8

Construction: Steel

1J7HY Female Seal-Lok™ Swivel 45° Elbow ISO 12151-1 - SWE45

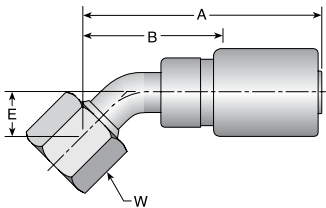

Part Number	Thread Size	Hose I.D.		A		Cutoff Allow. B		E		W Hex
		inch	mm	inch	mm	inch	mm	inch	mm	inch
#										
1J7HY-4-4	9/16x18	1/4	6	2.59	66	1.32	34	0.39	10	11/16
1J7HY-6-4	11/16x16	1/4	6	2.70	69	1.43	36	0.43	11	13/16
1J7HY-6-6	11/16x16	3/8	10	2.72	69	1.44	37	0.43	11	13/16
1J7HY-6-8	11/16x16	1/2	13	3.41	87	2.06	52	0.44	11	13/16
1J7HY-8-4	13/16x16	1/4	6	2.95	75	1.68	43	0.59	15	15/16
1J7HY-8-6	13/16x16	3/8	10	2.89	73	1.62	41	0.59	15	15/16
1J7HY-8-8	13/16x16	1/2	13	3.10	79	1.81	46	0.59	15	15/16
1J7HY-10-8	1x14	1/2	13	3.20	81	1.91	49	0.63	16	1-1/8
1J7HY-10-10	1x14	5/8	16	3.29	84	1.93	49	0.63	16	1-1/8
1J7HY-10-12	1x14	3/4	19	3.69	94	2.13	54	0.69	18	1-1/8
1J7HY-12-10	1-3/16x12	5/8	16	3.74	104	2.38	60	0.83	21	1-3/8
1J7HY-12-12	1-3/16x12	3/4	19	3.82	97	2.29	58	0.83	21	1-3/8
1J7HY-16-12	1-7/16x12	3/4	19	4.39	112	2.84	72	0.97	25	1-5/8
1J7HY-16-16	1-7/16x12	1	25	4.55	116	2.94	75	0.97	25	1-5/8

Construction: Steel

For detailed ordering information, please consult price list or contact Parflex® Division.

Parker Hannifin Corporation | Parflex® Division | Ravenna, Ohio | parker.com/pfd

www.comoso.com



E-121

A Hose
 B Tubing
 C Coiled Air Hose & Fittings
 D Transportation
 E Fittings Series HY
 F Tooling, Equipment & Accessories
 G General Technical

A Hose

1J9HY Female Seal-Lok™ Swivel 90° Elbow Short Drop ISO 12151-1 - SWES90

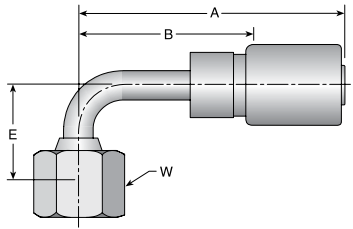

B Tubing

Part Number	Thread Size	Hose I.D.		A		Cutoff Allow. B		E		W Hex
		inch	mm	inch	mm	inch	mm	inch	mm	inch
#										
1J9HY-4-4	9/16x18	1/4	6	2.40	61	1.13	29	0.83	21	11/16
1J9HY-4-6	9/16x18	3/8	10	3.08	78	1.72	44	0.83	21	11/16
1J9HY-6-4	11/16x16	1/4	6	2.65	67	1.38	35	0.91	23	13/16
1J9HY-6-5	11/16x16	5/16	8	3/14	80	1.72	44	0.91	23	13/16
1J9HY-6-6	11/16x16	3/8	10	2.57	65	1.29	33	0.91	23	13/16
1J9HY-6-8	11/16x16	1/2	13	2.77	70	1.48	38	0.91	23	13/16
1J9HY-8-6	13/16x16	3/8	10	2.64	67	1.37	35	1.14	29	15/16
1J9HY-8-8	13/16x16	1/2	13	2.85	72	1.56	40	1.14	29	15/16
1J9HY-10-8	1x14	1/2	13	3.01	76	1.72	44	1.26	32	1-1/8
1J9HY-10-10	1x14	5/8	16	3.09	78	1.73	44	1.26	32	1-1/8
1J9HY-10-12	1x14	3/4	19	3.52	89	1.97	50	1.33	34	1-1/8
1J9HY-12-8	1-3/16x12	1/2	13	3.84	98	2.39	61	1.89	48	1-3/8
1J9HY-12-10	1-3/16x12	5/8	16	3.61	92	2.25	57	1.89	48	1-3/8
1J9HY-12-12	1-3/16x12	3/4	19	3.68	93	2.15	55	1.89	48	1-3/8
1J9HY-16-12	1-7/16x12	3/4	19	4.27	108	2.69	68	2.25	57	1-5/8
1J9HY-16-16	1-7/16x12	1	25	4.45	113	2.84	72	2.25	57	1-5/8
1J9HY-20-16	1-11/16x12	1	25	4.77	121	3.16	80	2.51	64	1-7/8

Construction: Steel

C Coiled Air Hose & Fittings

D Transportation

1JCHY Female Seal-Lok™ Swivel Short ISO 12151-1 - SWSA

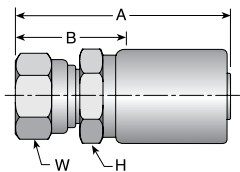

Part Number	Thread Size	Hose I.D.		A		Cutoff Allow. B		H Hex	W Hex
		inch	mm	inch	mm	inch	mm	inch	inch
#									
1JCHY-4-4	9/16x18	1/4	6	2.61	66	0.94	24	9/16	11/16
1JCHY-6-6	11/16x16	3/8	10	2.69	68	0.94	24	11/16	13/16
1JCHY-8-8	13/16x16	1/2	13	2.91	74	1.13	29	7/8	15/16
1JCHY-12-12	1-3/16x12	3/4	19	3.31	84	1.13	29	1-1/4	1-3/8

Construction: Steel

E Fittings Series HY

F Tooling, Equipment & Accessories

G General Technical



1JOHY Male Seal-Lok™ Rigid (with O-ring) ISO 1215-1 - S

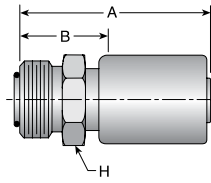

Part Number	Thread Size	Hose I.D.		A		Cutoff Allow. B		H Hex
		inch	mm	inch	mm	inch	mm	inch
#								
1JOHY-4-4	9/16x18	1/4	6	2.36	60	1.00	25	5/8
1JOHY-6-6	11/16x16	3/8	10	2.49	63	1.13	29	3/4
1JOHY-8-8	13/16x16	1/2	13	2.69	68	1.34	34	7/8
1JOHY-12-8	1-3/16x12	1/2	13	2.91	74	1.56	40	1-1/4

Construction: Steel

1JSHY Female Seal-Lok™ Swivel Long ISO 12151-1 - SWSB

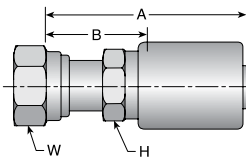

Part Number	Thread Size	Hose I.D.		A		Cutoff Allow. B		H Hex	W Hex
		inch	mm	inch	mm	inch	mm	inch	inch
#									
1JSHY-4-4	9/16x18	1/4	6	2.59	66	1.25	32	9/16	11/16
1JSHY-6-4	11/16x16	1/4	6	2.67	68	1.31	33	5/8	13/16
1JSHY-6-5	11/16x16	5/16	8	2.70	69	1.34	34	5/8	13/16
1JSHY-6-6	11/16x16	3/8	10	2.75	70	1.34	34	11/16	13/16
1JSHY-8-6	13/16x16	3/8	10	2.84	72	1.50	38	7/8	15/16
1JSHY-8-8	13/16x16	1/2	13	2.95	75	1.59	40	7/8	15/16
1JSHY-10-8	1x14	1/2	13	3.16	80	1.81	46	15/16	1-1/8
1JSHY-10-10	1x14	5/8	16	3.17	81	1.78	45	1-1/8	1-1/8
1JSHY-10-12	1x14	3/4	19	3.27	83	1.69	43	1-1/4	1-1/8
1JSHY-12-10	1-3/16x12	5/8	16	3.20	81	1.81	46	1-1/8	1-3/8
1JSHY-12-12	1-3/16x12	3/4	19	3.30	84	1.72	44	1-1/4	1-3/8
1JSHY-16-12	1-7/16x12	3/4	19	3.44	87	1.88	48	1-3/8	1-5/8
1JSHY-16-16	1-7/16x12	1	25	3.59	91	1.97	50	1-3/8	1-5/8
1JSHY-20-16	1-11/16x12	1	25	3.47	88	1.75	59	1-5/8	1-7/8
1JSHY-20-20	1-11/16x12	1-1/4	32	3.98	101	2.16	55	1-3/4	1-7/8

Construction: Steel

For detailed ordering information, please consult price list or contact Parflex® Division.

Parker Hannifin Corporation | Parflex® Division | Ravenna, Ohio | parker.com/pfd

www.comoso.com



A Hose
B Tubing
C Coiled Air Hose & Fittings
D Transportation
E Fittings Series HY
F Tooling, Equipment & Accessories
G General Technical

A
Hose

LV Series Visual Index



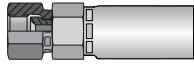

B
Tubing

LV Series PERMANENT	106	SAE (JIC) 37° Swivel
		
E-124		

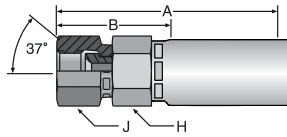
C
Coiled Air Hose & Fittings

106LV SAE (JIC) 37° Swivel



Part Number	Thread Size	Hose I.D.		A		Cutoff Allow. B		H Hex	J Hex
		inch	mm	inch	mm	inch	mm	inch	inch
#									
106LV-4-3	7/16-20	3/16	6	1.93	49	15/16	24	9/16	9/16
106LV-12-12	1-1/16-12	3/4	19	4.12	105	1-13/16	46	1-1/8	1-1/4
106LV-16-16	1-5/16-12	1	25	4.81	122	1-13/16	46	1-3/8	1-1/2

Construction: Steel nipple, nut and shell.

Add "C" for Stainless Steel.

D
Transportation

E
Fittings Series LV

F
Tooling, Equipment & Accessories

G
General Technical



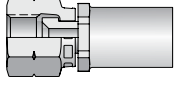
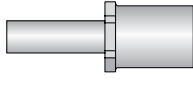
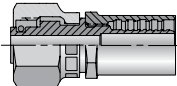

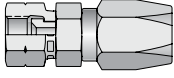
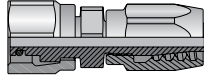
MS Series Visual Index

MS Series FIELD ATTACHABLE	108 SAE 45° Swivel	134 Straight Tube	1TF Marine Tube Connector
	 E-125	 E-125	 E-126

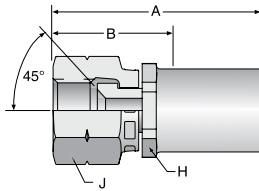
MS Series FIELD ATTACHABLE	208 SAE 45° Swivel	2TF Marine Tube Connector
	 E-126	 E-126

108MS Permanent SAE 45° Swivel (Brass)





Part Number	Thread Size	Hose I.D.		A		Cutoff Allow. B		H Hex	J Hex
		inch	mm	inch	mm	inch	mm	inch	inch
#									
108MS-6-5B	5/8-18	5/16	8	1.72	44	1-1/8	29	5/8	13/16
108MS-6-6B	5/8-18	3/8	10	1.82	46	1-1/16	27	3/4	13/16

Construction: Brass.

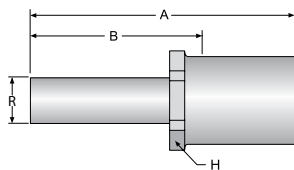
134MS Permanent Straight Tube (Brass)



Part Number	Diameter R		Hose I.D.		A		Cutoff Allow. B		H Hex
	inch	mm	inch	mm	inch	mm	inch	mm	inch
#									
134MS-6-5B	3/8	10	5/16	8	2.00	51	1-3/8	35	5/8
134MS-6-6B	3/8	10	3/8	10	2.08	53	1-3/8	35	3/4

Construction: Brass.

For detailed ordering information, please consult price list or contact Parflex® Division.

Parker Hannifin Corporation | Parflex® Division | Ravenna, Ohio | parker.com/pfd

www.comoso.com



A Hose
 B Tubing
 C Coiled Air Hose & Fittings
 D Transportation
 E Fittings Series MS
 F Tooling, Equipment & Accessories
 G General Technical

A Hose

1TFMS Permanent Marine Tube Connector (Brass)

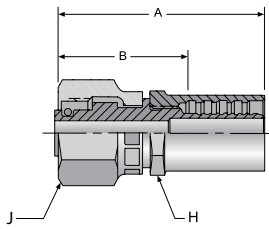

Part Number	Thread Size	Hose I.D.		A		Cutoff Allow. B		J Hex	H Hex
		inch	mm	inch	mm	inch	mm	inch	inch
#									
1TFMS-6-5B	9/16-24	5/16	8	1.70	43	1 1/16	27	3/4	5/8

Construction: Brass.

NOTE: Connector Mates are Manufactured by the Fluid Systems Connection Division. Refer to Catalog 3501E for Ordering, Installation Instructions and Replacement Components.

B Tubing

C Coiled Air Hose & Fittings

208MS Field-Attachable SAE 45° Swivel (Brass)

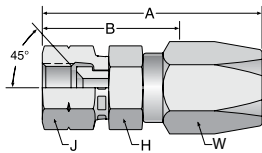

Part Number	Thread Size	Hose I.D.		A		Cutoff Allow. B		J Hex	H Hex	W Hex
		inch	mm	inch	mm	inch	mm	inch	inch	inch
#										
208MS-6-5B	5/8-18	5/16	8	2.06	52	1 5/16	33	13/16	5/8	13/16
208MS-6-6B	5/8-18	3/8	10	2.37	60	1 7/16	37	13/16	5/8	13/16

Construction: Brass.

D Transportation

E Fittings Series MS

2TFMS Field-Attachable Marine Tube Connector (Brass)

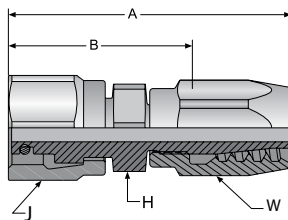

Part Number	Thread Size	Hose I.D.		A		Cutoff Allow. B		J Hex	H Hex	W Hex
		inch	mm	inch	mm	inch	mm	inch	inch	inch
#										
2TFMS-6-5B	9/16-24	5/16	8	2.02	51	1 5/16	33	3/4	5/8	3/4

Construction: Brass.

NOTE: Connector Mates are Manufactured by the Fluid Systems Connection Division. Refer to Catalog 3501E for more information.

F Tooling, Equipment & Accessories

G General Technical

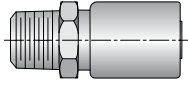
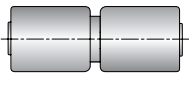

SQ Series Visual Index

SQ Series PERMANENT	101	Male Taper Pipe Rigid	1HU	SQ Mender
	 E-127		 E-127	

1HUSQ Mender

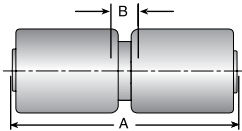

Part Number		Hose I.D.		A		Cutoff Allow. B	
#		⊙					
Hose		inch	mm	inch	mm	inch	mm
S410	1HUSQ-10-10	5/8	16	3.90	100	5/16	8
S612	1HUSQ-12-12	3/4	19	3.70	94	9/16	14
S616	1HUSQ-16-16	1	25	3.99	101	9/16	14
S620	1HUSQ-20-20	1-1/4	32	4.53	115	9/16	14
S912	1HUSQ-12-12	3/4	19	3.70	94	9/16	14
S916	1HUSQ-16-16	1	25	3.99	101	9/16	14

Construction: Steel

NOTE: See pg. G-42 for swage die selection.

101SQ Male Taper Pipe Rigid

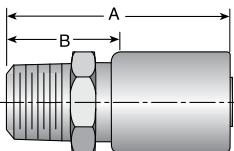

Part Number		Hose I.D.		A		Cutoff Allow. B	
#		⊙					
Hose		inch	mm	inch	mm	inch	mm
S612	101SQ-12-12	3/4	19	3.08	78	1-1/2	38
S616	101SQ-16-16	1	25	3.42	87	1-13/16	46
S620	101SQ-20-20	1-1/4	32	3.84	98	2	51
S912	101SQ-12-12	3/4	19	3.08	78	1-1/2	38
S916	101SQ-16-16	1	25	3.42	87	1-13/16	46

Construction: Steel

NOTE: See pg. G-42 for swage die selection.

For detailed ordering information, please consult price list or contact Parflex® Division.



A Hose
 B Tubing
 C Coiled Air Hose & Fittings
 D Transportation
 E Fittings Series SQ
 F Tooling, Equipment & Accessories
 G General Technical

Tooling Equipment & Accessories



MiniKrimp™

Karrykrimp

Karrykrimp 2

Parkrimp2

Pumps

Accessories



Table of Contents

Crimpers

Karrykrimp	F-10
Karrykrimp 2	F-11
MiniKrimp™	F-5
Parkrimp 2	F-12

Pumps

Air Over Hydraulic Pumps	F-13
Electric Pumps	F-14
Hand Pumps.....	F-13 : F-14

Conversion Kits

Hydraulic Press, Gates, Weatherhead.....	F-16
--	------

Sewer Hose Swager & Swage Tooling

SQ-101-SW Swager/Mender	F-13
-------------------------------	------

Accessories

Cut-off Tools	F-17
Dies (Parkrimp 2)	F-15
Die Racks	F-15
Hose Guards/Sleeves.....	F-18 : F-23
Vise Blocks.....	F-14
Hose Insertion Depth Blocks.....	F-14





Technical

MiniKrimp Assembly Detail	F-8 : F-9
Spring/Armor/PVC Guard Selection Tables.....	F-18 : F-19











Tooling, Equipment & Accessories Visual Index

MiniKrimp™	94C-001-PFD	94C-002-PFD	Hose Stand 94C-MKS
	 F-5	 F-5	 F-7

Karrykrimp	Karrykrimp 82C-061L-PFD	Karrykrimp Bench Mount 82C-KKB-PFD	Karrykrimp2 85C-061L-PFD	Karrykrimp 2 Bench Mount 85C-KKB-PFD
	 F-10	 F-10	 F-11	 F-11

Parkrimp 2	Parkrimp 2 83C-081-PFD
	 F-12

Swagers, Swager Tooling	Swager Mender SQ-101-SW
	 F-13

Pumps	Hand Pump 015301	Hand Pump 82C-0HP-PFD	Hand Pump 85C-0HP-PFD	Air/Hydraulic Pump 025399	Air/Hydraulic Pump 82C-0AP
	 F-13	 F-14	 F-14	 F-13	 F-13
	Electric Pump 82C-0EP-PFD	Electric Pump 85C-0EP-PFD			
	 F-14	 F-14			

Parkrimp Dies	Dies	Die Storage Racks
	 F-15	 F-15

For detailed ordering information, please consult price list or contact Parflex® Division.



Parker Hannifin Corporation | Parflex® Division | Ravenna, Ohio | parker.com/pfd



www.comoso.com







A Hose
B Tubing
C Coiled Air Hose & Fittings
D Transportation
E Fittings
F Tooling, Equipment & Accessories
G General Technical

Tooling, Equipment & Accessories Visual Index

Conversion Kits	Hydraulic Press Kit	Weatherhead Kit	Gates Kit
	 F-16	 F-16	 F-16

Vise Blocks	Vise Blocks VBS & VBL	Hose Insertion Depth Blocks	TH-9-1-xxx TH-8-1-xxx
	 F-14		 F-14

Cutoff Tools	Hose Cutoff Machine 332T-115V	Push-Lok Cut-Off 885140	Hose Cutter HTC	Hose Cutter TH11-1	Plastic Tube Cutter PTC
	 F-17	 F-17	 F-17	 F-17	 F-17

Hose Guards & Sleeves	AG Flat Steel Armor	AS Partek Sleeve	CNG CNGG Guard Kit	FS Fire Sleeve	HBR Bend Restrictor
	 F-19	 F-20*	 F-18	 F-20*	 F-18
	MG External Anti-Kink Casing	PSG and SSG Pre-Made Spring	PSG Parker Spiral Guard	PV Clear Vinyl	SG Steel Spring Guard
	 F-20*	 F-19	 F-23	 F-18	 F-19
	2613 Internal Flat Spring	2625 External Round Spring	2740 External Flat Spring	2799 Internal Round Spring	
	 F-20*	 F-20*	 F-20*	 F-20*	

* Items on page F-20 are for PTFE hose.



Crimping Machines

MiniKrimp™ Hand Pump Model Part No. 94C-001-PFD

The Parker Hannifin MiniKrimp is the best portable crimper on the market. By utilizing a one-piece, high-strength cast aluminum frame, the MiniKrimp is light, robust and highly corrosion resistant.

For use with 54, 55, 56, 57, 58, 91, 91N, 92, 93N, CY, MS, SF and HY Series fittings



Features

- Lightweight, portable, compact all-in-one unit
- Unit with pump weighs only 42 pounds
- 10,000 psi and 30+ tons of force
- No gauges to set - exclusive Parkalign™ feature positions the fitting correctly every time
- Removable pusher design for easy die change
- Hand pump easily removed for use with jumper hose for bench-mounted units (Part No.- 015309)
- No additional power source required for operation
- Capable of crimping a majority of thermoplastic, rubber, PTFE and specialty hoses up to 3/4" I.D.

Specifications

- Dimensions: 6" Deep, 13" Wide, 15" High
- Weight: 42 lbs with hand pump
- Rating: 30 tons force @ 10,000 psi maximum
- Full Cycle Time: Approximately 30 seconds

Standard Equipment

Part Number		Description	Individual
94C-001-PFD	94C-002-PFD		Part Number
●	●	Base unit	94C-080-PFD
●		Hand pump	015301
	●	Air over hydraulic pump kit with tubing and adapters	025399
●	●	Silver die ring	82C-R01-PFD

MiniKrimp™ Air Over Hydraulic Model Part No. 94C-002-PFD

The Parker Hannifin MiniKrimp is the best portable crimper on the market. By utilizing a one-piece, high-strength cast aluminum frame, the MiniKrimp is light, robust and highly corrosion resistant.

For use with 54, 55, 56, 57, 58, 91, 91N, 92, 93N, CY, MS, SF and HY Series fittings



Features

- Lightweight, portable, compact all-in-one unit
- Unit with pump weighs only 45 pounds
- 10,000 psi and 30+ tons of force
- No gauges to set - exclusive Parkalign™ feature positions the fitting correctly every time
- Removable pusher design for easy die change
- Air pump utilizes a rugged activation and release lever for greater durability
- Can operate with as little as 60 psi air pressure (60-100 psi, 9 CFM recommended)
- Capable of crimping a majority of thermoplastic, rubber, PTFE and specialty hoses up to 3/4" I.D.

Specifications

- Dimensions: 6" Deep, 12" Wide, 15" High
- Weight: 45 lbs with air/hydraulic pump
- Rating: 30 tons force @ 10,000 psi maximum
- Full Cycle Time: Approximately 30 seconds

Operating Parameters

Reference Crimpsource™ online or appropriate catalog (4660 or 4400) of the Parker division that supplies the hose for detailed crimp specifications as exceptions do occur based on the particular hose type, size, and fitting material.
www.parker.com/crimpsource

For detailed ordering information, please consult price list or contact Parflex® Division.

Parker Hannifin Corporation | Parflex® Division | Ravenna, Ohio | parker.com/pfd

www.comoso.com



F-5

A Hose

B Tubing

C Coiled Air Hose & Fittings

D Transportation

E Fittings

F Tooling, Equipment & Accessories

G General Technical

MiniKrimp™ Crimping Machine Accessories



Upright Vise Mount

Part No. 015307

- Machined and bent from high strength steel
- Mount connects to the bottom of the MiniKrimp using four 3/8-16 bolts (not included)
- Once connected, MiniKrimp can be clamped into a vise for operation



Table Mount

Part No. 015306

- Machined and bent from high strength steel
- Mount connects to the bottom of the MiniKrimp using four 3/8-16 bolts (not included)
- MiniKrimp can then be mounted to a table using the four 3/8" clearance holes on the other side of the plate (bolts not included)



High Pressure Hose Assembly

Part No. 015309

- Parker 10,000 psi, 1/4" I.D. hose with 3/8" female JIC connections on both ends (PN HP0606060604-72")
- Hose is 6' long
- Hose is used when a flexible connection is required between the MiniKrimp and a hydraulic pressure source



Replacement Connector

Part No. 015308

- Replacement stainless-steel bent tube rigid connector
- For use with 94C-001-PFD (MiniKrimp Hand Pump Model)



Replacement Connector

Part No. 025349

- Replacement stainless-steel bent tube rigid connector
- For use with 94C-002-PFD (MiniKrimp Air Over Hydraulic Model)

Note: The hydraulic connectors shown on this page are designed exclusively for use with the MiniKrimp. No other connectors are approved for use with the MiniKrimp without expressed written consent from Parker Parflex Division's technical support. Any worn connectors should be replaced immediately.



High Pressure Hose Assembly

Part No. 045234

- Parker 10,000 psi, 1/4" I.D. hose with quick coupler
- Hose is designed to be used when mounting a hand pump to the 94C-MKS MiniKrimp stand's base

ie: HP Hose Assembly with 3000 Series quick disconnects
 PN HP0101040604-36 (12" guard) with 3050-2/3010-2 coupler and nippler



Folding Stand

Part No. 94C-MKS

(See pictures below for configuration examples)

- Lightweight folding stand designed exclusively for the MiniKrimp portable crimper
- Fold up design is easy to store
- Mounting hardware and safety instructions are included
- Patented design



Hand Pump
MiniKrimp™

Hand Pump
MiniKrimp™

Air Over Hydraulic
MiniKrimp™

Air Over Hydraulic
MiniKrimp™ and
Folding Stand

For detailed ordering information, please consult price list or contact Parflex® Division.

Parker Hannifin Corporation | Parflex® Division | Ravenna, Ohio | parker.com/pfd

www.comoso.com



MiniKrimp™ Assembly Detail & Parts List

Hand Pump Model

Part No.	Description	Qty.
015301	2 Speed Light Weight Hand Pump	1
015302	Hardened Steel Sleeve	1
015303	Custom Cylinder	1
015304	Aluminum Frame	1
015305	Cup Pusher	1
015306	Bent Tube Assembly	1
015310	3/8" x 3/8" Shoulder Bolt	1
015415	Spring Plunger	1
6 CTX-S	3/8" 37° to 1/4" NPT Elbow	1
6-6 CTX-S	3/8" 37° to 3/8" NPT Elbow	1
822011	Die Separator	1
822012	Spring	1
822031	Retention Ring	1
82C-R01-PFD	Silver Die Ring	1
015411	3/8-16 18-8 SS SHCS 2.5" Long	2
015413	1/4-20 18-8 SS Lock Washer	2
015414	1/4-20 18-8 SS Flat Washer	2
015412	1/4-20 18-8 SS SHCS .75" Long	4

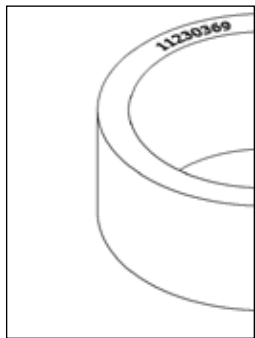
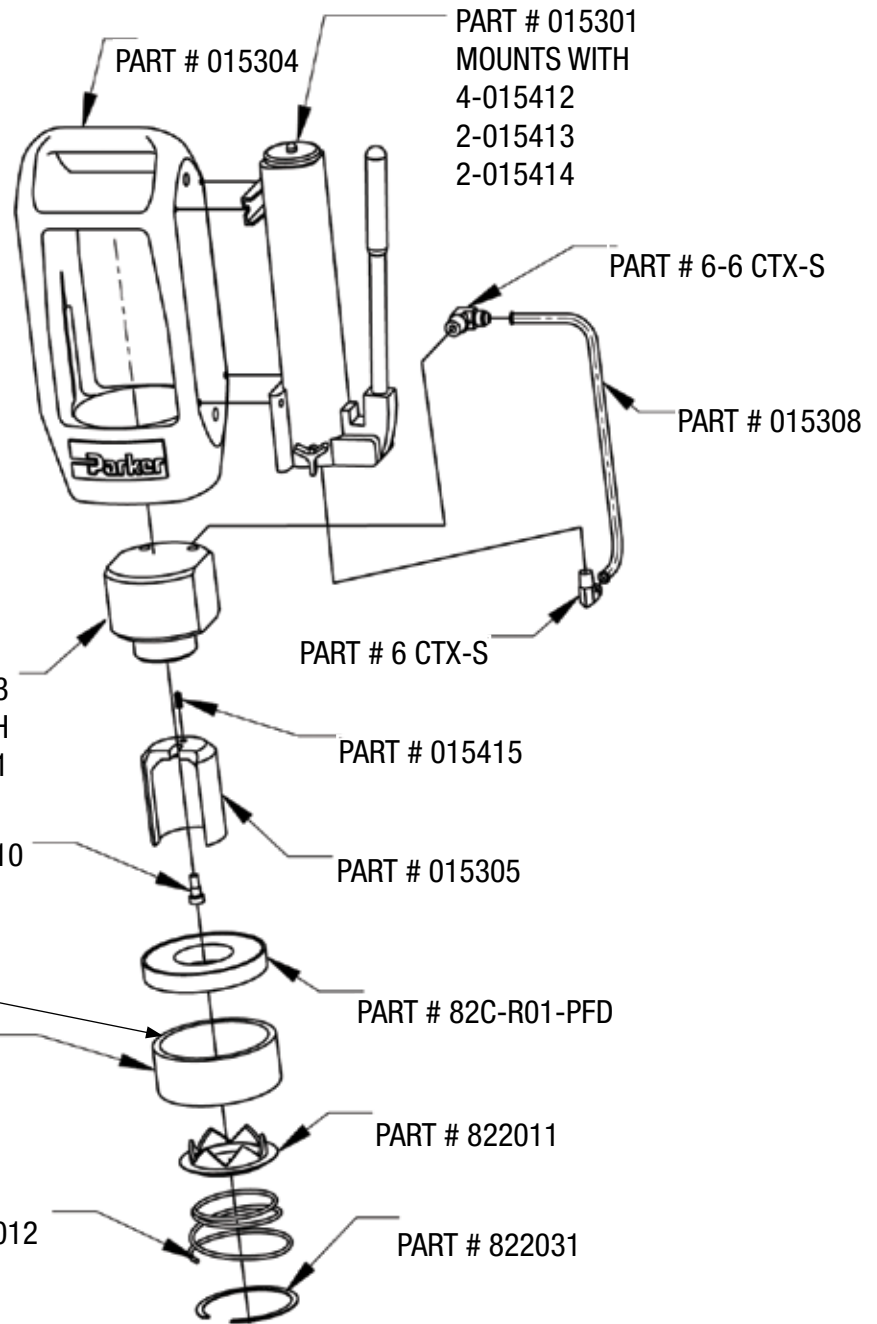

MiniKrimp™ Serial Number



Air Over Hydraulic Model

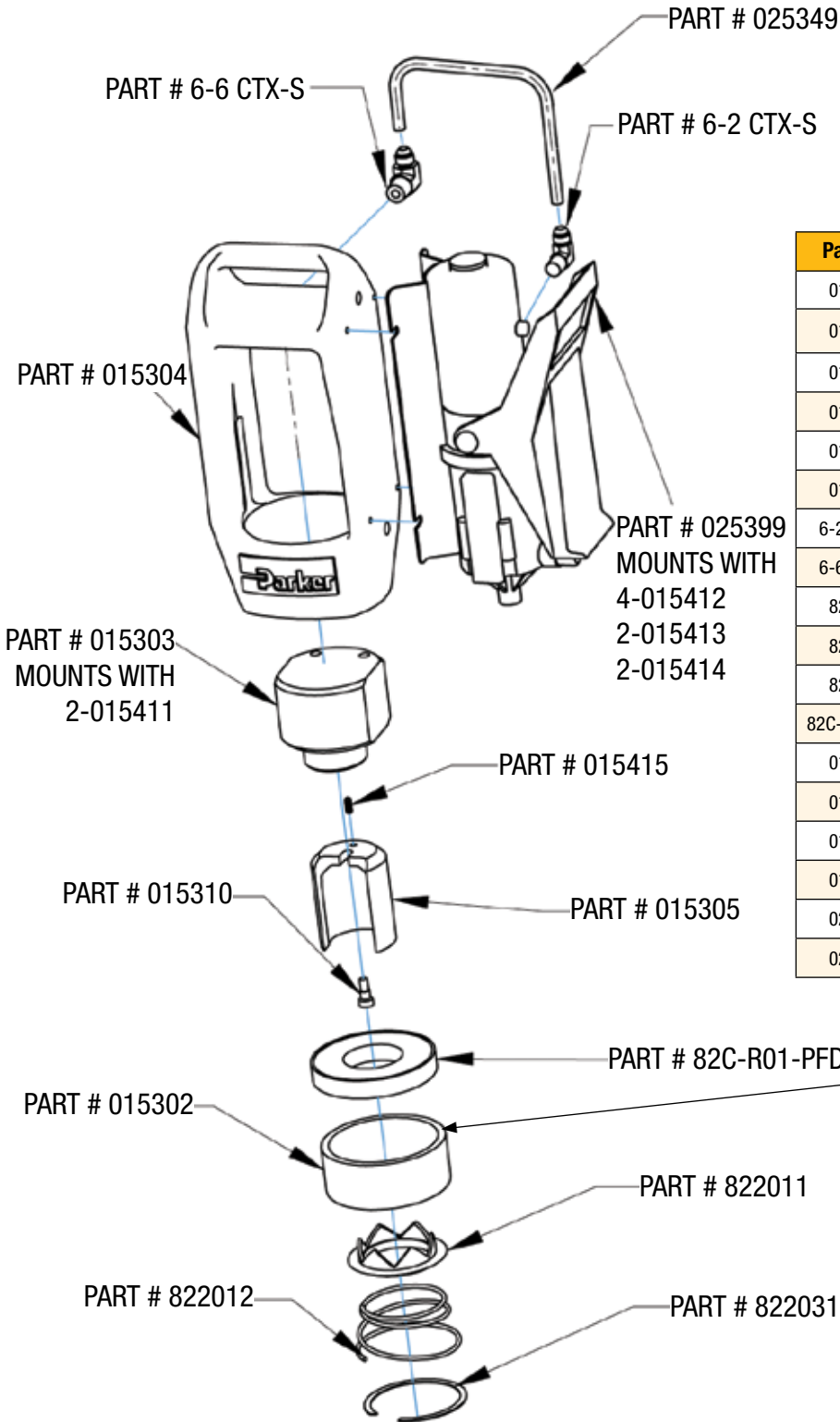

Part No.	Description	Qty.
015302	Hardened Steel Sleeve	1
015303	Custom Cylinder	1
015304	Aluminum Frame	1
015305	Cup Pusher	1
015310	3/8" x 3/8" Shoulder Bolt	1
015415	Spring Plunger	1
6-2 CTX-S	3/8" 37° to 1/8" NPT Elbow	1
6-6 CTX-S	3/8" 37° to 3/8" NPT Elbow	1
822011	Die Separator	1
822012	Spring	1
822031	Retention Ring	1
82C-R01-PFD	Silver Die Ring	1
015411	3/8-16 18-8 SS SHCS 2.5" Long	2
015413	1/4-20 18-8 SS Lock Washer	2
015414	1/4-20 18-8 SS Flat Washer	2
015412	1/4-20 18-8 SS SHCS .75" Long	4
025349	Bent Tube Assembly	1
025399	Air Powered Pump	1

A Hose
 B Tubing
 C Coiled Air Hose & Fittings
 D Transportation
 E Fittings
 F Tooling, Equipment & Accessories
 G General Technical

For detailed ordering information, please consult price list or contact Parflex® Division.

Parker Hannifin Corporation | Parflex® Division | Ravenna, Ohio | parker.com/pfd

www.comoso.com



Karrykrimp

Part No. 82C-061L-PFD

The Karrykrimp is now available in a modular design with all the familiar Parkrimp System advantages.

The same unit now offers portability and bench mountability.



Capability

- Crimps most hoses up to 1-1/4 I.D. (check crimpsource for details)

Features

- Portable, compact rugged design
- Numerous portable power unit options available
- Pivoting pusher design for easy die change out
- Increased height enables longer bent tube fittings to be crimped
- For use with 54, 55, 56, 57, 58, 91, 91N, 92, 93N, CY, MS, SF and HY Series fittings

Specifications

- Dimensions: 15" wide, 12" deep, 30" high
- Weight: 60 lbs (without power unit)
- Rating: 30 ton force @ 10,000 psi maximum
- Full Cycle Time: 30 seconds

Standard Equipment

Part Number			Description	Individual
82C-CHD-PFD	82C-061L-PFD	82C-KKB-PFD		Part Number
●	●	●	Crimp Head	82C-CHD-PFD
		●	Bench Power Unit Assembly	85C-1PH-PFD
●	●	●	Silver die ring	82C-R01-PFD
●	●	●	Black die ring	82C-R02-PFD
	●		Hose Assembly	85C-00L-PFD
	●		Stand Assembly	85C-STD-PFD

Karrykrimp Bench Mount

Part No. 82C-KKB-PFD



View Video Tutorial

Capability

- Crimps most hoses up to 1-1/4 I.D. (check crimpsource for details)

Features

- Faster cycle times on bench mounted units
- Pivoting pusher design for easy die change out
- Compact bench mount design
- Increased height enables longer bent tube fittings to be crimped
- For use with 54, 55, 56, 57, 58, 91, 91N, 92, 93N, CY, MS, SF and HY Series fittings

Specifications

- Dimensions: 17" wide, 23" deep, 27-1/2" high
- Weight: 146 lbs
- Rating: 30 ton force @ 10,000 psi maximum
- Full Cycle Time: 11 seconds
- Hydraulic Fluid: AW32 oil

This unit is designed to make about 400 crimps per day and is not designed to be a production crimper. Exceeding these suggested production amounts will significantly reduce the life expectancy of the crimper components.

Note:

Motor is dual voltage, 50/60hz suitable for 208-230/115v, 1ph, 60hz and 220-230/110v, ph, 50hz. Motor can be rewired by a qualified electrician to operate at alternate voltage.

Karrykrimp 2

Part No. 85C-061L-PFD

The Karrykrimp 2 is now available in a modular design with all the familiar Parkrimp System advantages.

The same unit now offers portability and bench mountability.



Capability

- Crimps most hoses up to 1-1/4 I.D. (check crimpsource for detail)

Features

- Portable, compact rugged design
- Numerous portable power unit options available
- Pivoting pusher design for easy die change out
- For use with 54, 55, 57, 58, 91, 91N, 92, 93N, CY, MS, SF and HY Series fittings

Specifications

- Dimensions: 14" wide, 14" deep, 31-1/2" high
- Weight: 120 lbs (without power unit)
- Rating: 60 ton force @ 10,000 psi maximum
- Full Cycle Time: 20 seconds

Standard Equipment

Part Number			Description	Individual
85C-CHD-PFD	85C-061L-PFD	85C-KKB-PFD		Part Number
●	●	●	Crimp Head	85C-CHD-PFD
		●	Bench Power Unit Assembly	85C-1PH-PFD
●	●	●	Silver die ring	85C-R01-PFD
●	●	●	Black die ring	85C-R02-PFD
	●		Hose Assembly	85C-00L-PFD
	●		Stand Assembly	85C-STD-PFD

Karrykrimp 2 Bench Mount

Part No. 85C-KKB-PFD



View Video Tutorial



Capability

- Crimps most hoses up to 1-1/4 I.D. (check crimpsource for detail)

Features

- Faster cycle times on bench mounted units
- Pivoting pusher design for easy die change out
- Compact bench mount design
- For use with 54, 55, 57, 58, 91, 91N, 92, 93N, CY, MS, SF and HY Series fittings

Specifications

- Dimensions: 17" wide, 23" deep, 28" high
- Weight: 208 lbs
- Rating: 60 ton force @ 10,000 psi maximum
- Full Cycle Time: 17 seconds
- Hydraulic Fluid: AW32 oil

This unit is designed to make about 400 crimps per day and is not designed to be a production crimper. Exceeding these suggested production amounts will significantly reduce the life expectancy of the crimper components.

Note:

Motor is dual voltage, 50/60hz suitable for 208-230/115v, 1ph, 60hz and 220-230/110v, ph, 50hz. Motor can be rewired by a qualified electrician to operate at alternate voltage.

For detailed ordering information, please consult price list or contact Parflex® Division.

Parker Hannifin Corporation | Parflex® Division | Ravenna, Ohio | parker.com/pfd

www.comoso.com



F-11

A Hose

B Tubing

C Coiled Air Hose & Fittings

D Transportation

E Fittings

F Tooling, Equipment & Accessories

G General Technical

Parkrimp 2

Part No. 83C-081-PFD



View video tutorial

Capability

- Crimps hoses up to 2" I.D.
(reference crimp source for details)

Features

- Easy to use vertical design
- Crimps full range of Parker hoses from 1/8" through 2" I.D.
- For use with 54, 55, 56, 57, 58, 58H, 91, 91N, 92, 93N, CY, LV, MS, SF and HY Series fittings

Specifications

- Dimensions: 31" wide, 24" deep, 77" high
- Weight: 842 lbs (Head is 558 lbs and base is 284 lbs)
- Rating: 125 ton force @ 5,000 psi maximum
- Full Cycle Time: 30 seconds without adapter bowl
20 seconds with adapter bowl
- Hydraulic oil: Enerpac oil only

Standard Equipment

Part Number				Description	Individual
83C-001-PFD	83C-081-PFD	83C-002-PFD	83C-082-PFD		Part Number
●	●	●	●	Parkrimp 2 crimper head assembly	83C-080-PFD
●	●			Parkrimp 2 stand assembly with 230/460 volt, 3 phase, 50/60 Hz power unit (wired for 230 volt)	83C-S40-PFD
		●	●	Parkrimp 2 stand assembly with 230 volt, 1 phase, 50/60 Hz power unit	83C-S20-PFD
●	●	●	●	Adapter bowl	83C-OCB-PFD
●	●	●	●	Spacer ring	83C-R02-PFD
●	●	●	●	Spacer Plate	83C-R02H-PFD



For detailed ordering information, please consult price list or contact Parflex® Division.

Crimper Pumps

Air/Hydraulic Pump Part No. 82C-0AP-PFD

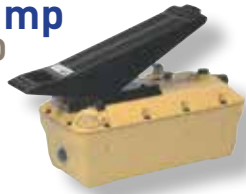

(for use with the MiniKrimp, Karrykrimp and Karrykrimp 2)
Lightweight pump operates with 80-110 psi shop air pressure and delivers 10,000 psi

- Length: 15"
- Width: 6"
- Height: 6"
- Intake Port Size: 1/4" NPTF
- Output Port Size: 3/8" NPTF
- Weight: 14 lbs
- Hydraulic Fluid: Enerpac oil only

Air/Hydraulic Pump Part No. 025399



(for use with the MiniKrimp)
Lightweight pump operates with 80-110 psi shop air pressure and delivers 10,000 psi

- Length: 13"
- Width: 4-1/2"
- Height: 5"
- Intake Port Size: 1/4" NPTF
- Output Port Size: 1/8" NPTF
- Weight: 12 lbs.
- Hydraulic Fluid: Enerpac oil only

Hand Pump Part No. 015301



(for use with the MiniKrimp)
Ease of operation hand pump delivers 10,000 psi

- Length: 13-3/8"
- Width: 3-1/4"
- Height: 3-5/8"
- Port Size: 1/4" NPTF
- Weight: 4.7 lbs.
- Hydraulic Fluid: Enerpac oil only

Swagers



SQ-101-SW Swager/Mender

- Used for field assembly or repair on Predator S6 and S9 hoses

For detailed ordering information, please consult price list or contact Parflex® Division.

Parker Hannifin Corporation | Parflex® Division | Ravenna, Ohio | parker.com/pfd

www.comoso.com



F-13

A Hose

B Tubing

C Coiled Air Hose & Fittings

D Transportation

E Fittings

F Tooling, Equipment & Accessories

G General Technical

Hand Pump

Part No. 82C-0HP-PFD



(for use with the MiniKrimp, Karrykrimp and Karrykrimp 2)

Ease of operation hand pump delivers 10,000 psi

- Length: 13-3/8"
- Width: 3-1/4"
- Height: 3-5/8"
- Port Size: 1/4" NPTF
- Weight: 4.7 lbs.
- Hydraulic Fluid: Enerpac oil only

Hand Pump

Part No. 85C-0HP-PFD



(for use with the MiniKrimp, Karrykrimp and Karrykrimp 2)

Ease of operation hand pump delivers 10,000 psi

- Length: 29"
- Width: 13"
- Height: 11"
- Port Size: 3/8" NPTF
- Weight: 61 lbs
- Hydraulic Fluid: Enerpac oil only

Electric Pump

Part No. 82C-0EP-PFD



(for use with the MiniKrimp, Karrykrimp and Karrykrimp 2)

Ease of operation electric pump delivers 10,000 psi

- Length: 13"
- Width: 13"
- Height: 15"
- Port Size: 3/8" NPTF
- Weight: 31 lbs
- Hydraulic Fluid: Enerpac oil only
- 115 volt, 1 phase, 50/60 Hz, 9 amp

Electric Pump

Part No. 85C-0EP-PFD



(for use with the MiniKrimp, Karrykrimp and Karrykrimp 2)

Heavy duty electric pump delivers 10,000 psi at a faster cycle time

- Length: 19"
- Width: 11"
- Height: 17"
- Port Size: 3/8" NPTF
- Weight: 59 lbs
- Hydraulic Fluid: Enerpac oil only
- 115 volt, 1 phase, 50/60 Hz, 20 amp

Vise Blocks

For Parflex Hose Sizes



Part Number	Hose Size	
	VBS	-3
-4		1/4
-5		5/16
-6		3/8
-8		1/2
VBL	-12	3/4
	-16	1

Hose Insertion Dept Blocks

Part No. TH9-1-xxx

Part No. TH8-1-xxx



Part Number	Description
TH8-1-55-58	55 & 58 Series. All sizes.
TH9-1-56	56 Series. All sizes.
TH9-1-58H	58H Series. All sizes.
TH9-1-54A	54 Series All sizes.
TH9-1-91N	91N Series. All sizes.
TH9-1-93N-20-32	93N Series. Sizes: -20, -24, -32
TH9-1-93N-6-16	93N Series. Sizes: -6, -12, -16
TH9-1-94-95	94 & 95 Series. All sizes.
TH9-1-CY-SF	CY & SF Series. All sizes.
TH9-1-MS	MS Series. All sizes.
TH9-1-HY	HY Series. All sizes.

Parflex Parkrimp Dies



Parkrimp dies, specifically engineered for thermoplastic and fluoropolymer hose:

- Linked die segments
- Pre-matched and assembled
- Fitting size color coded

Color Code	
Size	Color
-1.5	GR
-2	BR
-3	GR
-4	R
-5	P

Color Code	
Size	Color
-6	Y
-8	BL
-10	O
-12	G
-16	B

Color Code	
Size	Color
-20	W
-24	R
-32	G

Parkrimp Approved Silver Die Rings	
Machine	Approved Die
Parkrimp 2	NA*
Karrykrimp and MiniKrimp	82C-R01-PFD
Karrykrimp 2	85C-R01-PFD

*No additional silver die rings required.

Note: 1) Parflex dies have been designed for use with the silver die ring. Silver die rings are to be used with all Parflex hoses unless otherwise specified.

2) For most Parker products, Crimp Die information and selection charts can be found online at www.parker.com/crimpsource. Access instructions are on pg. G-13.

Die Racks



Die Storage Rack

Part No. 80C-0DR-PFD/83C-0DR-PFD

- Holds small and large Parkrimp dies
- Can be bolted together to a work bench

Description	Part No.
Storage 3 small dies	80C-0DR-PFD
Storage 2 large dies	83C-0DR-PFD



Swivel Die Rack

Part No. 80C-SDR-XXXX-PFD

- Holds up to 30 Parkrimp dies
- Powder coated, heavy duty steel construction
- Consist of base unit and up to 5 circular holders
- Floor or bench mounted

Description	Part No.
Swivel Die Rack and Small Die Holder	80C-SDR-SM-PFD
Swivel Die Rack and Large Die Holder	80C-SDR-LG-PFD
Swivel Die Rack Base	80C-SDR-BASE-PFD

For detailed ordering information, please consult price list or contact Parflex® Division.

Parker Hannifin Corporation | Parflex® Division | Ravenna, Ohio | parker.com/pfd

www.comoso.com



F-15

A Hose

B Tubing

C Coiled Air Hose & Fittings

D Transportation

E Fittings

F Tooling, Equipment & Accessories

G General Technical

Conversion Kits



Hydraulic Press Kit

Specifications

- Required Height from Press Base to Press Ram: 10 inches
- Required Width of Bowl Diameter: 5 inches
- Bowl Rating: 30 tons force maximum
- Minimum Required Press Capacity: Hose Size 1/4" to 1/2" needs a 20 ton press
Hose size 5/8" to 1-1/4" needs a 30 ton press

Standard Equipment

Each component must be ordered separately	Individual
Description	Part Number
Bowl Assembly	8PC-030-PFD
Pusher	8PC-00P-PFD
Silver Die Ring	81C-R01-PFD
Black Die Ring	81C-R02-PFD



Weatherhead Conversion Kit

Weatherhead T-400 crimper to utilize Parker Parkrimp No-Skive fittings.

Standard Equipment

Each component must be ordered separately	Individual
Description	Part Number
Bowl Assembly	8PC-030-PFD
Pusher	8PC-00P-PFD
Silver Die Ring	81C-R01-PFD
Black Die Ring	81C-R02-PFD



Gates Conversion Kit

Convert Gates 701, 703 and 707 bottom loading crimpers to utilize Parker Parkrimp No-Skive fittings.

Standard Equipment

Each component must be ordered separately	Individual
Description	Part Number
Bowl Assembly	8PC-030-PFD
Silver Die Ring	81C-R01-PFD
Black Die Ring	81C-R02-PFD

Cutting Tools



Hose Cut-Off Machine Part No. 332T-115V-PFD

Features

- For quick, easy cutting of spiral reinforced hose up to 1-1/4" I.D.
- Moving parts shielded by guards

Specifications

- Dimensions: 13" wide x 26" long x 22" high
- Shipping Weight: 71 lbs.

Standard Equipment

Part Number	Description	Individual Part Number
332T-115V-PFD		
●	Hose Cut-Off Machine with 1-1/2 HP, 3450 RPM, 115/230V single phase electric motor wired for 115V	
●	Scallop Cutting Blade (8" with 5/8" arbor size)	24398-PFD

Optional Equipment

Smooth Cutting Blade (580661-PFD)



Push-Lok Cut-Off & Assembly Tool Part No. 881540-PFD

- Combines hose cutter and toggle action press
- Cuts and assembles Parker 83FR in sizes 1/4" through 3/4" I.D.



Hose & Tubing Cutter Part No. HTC

- Special V-block design with easy adjustable blade ensures a straight, clean cut
- Minimal flattening of hose/tubing during cutting - Straight, square cut enhances fitting retention
- Cuts up to 1" O.D. hose or tubing (Non-wire reinforced thermoplastic hose and tubing and rubber hose and tubing)
- Replacement blades: HTC-RB



Hose Cut-Off Tool Part No. TH11-1-PFD

- Designed for quick, easy cutting of textile reinforced hose
- Squarely cuts fiber reinforced hoses in sizes 1/4" through 3/4" I.D.



Plastic Tube Cutter Part No. PTC

- Razor-edged tube cutter
- Closes automatically, assuring clean and square cuts
- May be used with most plastic tubing up to 5/8" I.D.

Description	Part Number
Replacement Blades.....	PTC-001-RB

For detailed ordering information, please consult price list or contact Parflex® Division.

Hose Guards

Parker hose guards prolong the life of hoses that are exposed to rugged operating conditions. In addition to protecting the hose from abrasion and cutting, they limit the bending radius which prevents kinking.

PV - Clear Vinyl Hose Guard

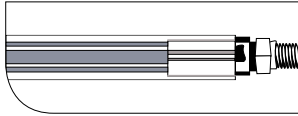

Part Number	Guard I.D.		Standard Length	
	inch	mm	feet	mtr.
#	⊙			
PV97-1	0.44	11	100	30.5
PV139-1	0.56	14	100	30.5
PV1611-1	0.68	17	100	30.5
PV2014-1	0.87	22	50	15.2
PV2420-1	1.25	32	50	15.2
PV3224-1	1.50	38	50	15.2

HBR - Hose Bend Restrictor (Black Elastomer)

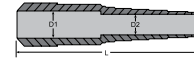

Part Number	Hose Size	L		D1		D2	
		inch	mm	inch	mm	inch	mm
#	⊙						
HBR-4	1/4	6	5	127	.600	15	.500
HBR-6	3/8	10	6	152	.640	16	.625

Parker reserves the right to change dimensions and performance parameters without notice.

5CNG/CNGLT - Black Vinyl CNG Hose Guard

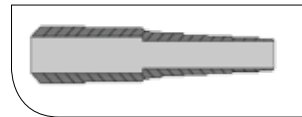

Hose Part Number	Hose Guard Part Number
#	#
5CNG-3	CNGG5-3
5CNG-4	CNGG5-4
5CNG-6	HBR-6
5CNG-8	CNGG5-8
5CNG/CNGLT-12	CNGG5-12
5CNG/CNGLT-16	CNGG5-16

- Use with Parflex CNG hose
- Contact Parflex Division for information on Hose Guard Kits.

Metallic Spring Guards

Use Spring Guards for protection from abrasion and extreme physical abuse.

SSG & PSG - Pre-made Spring Guards

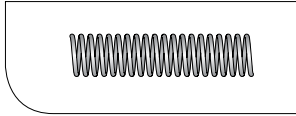

Plated, hard-drawn steel wire

Part Number	Hose O.D. (reference)		Standard Length	
	inch	mm	inch	mm
#	⊙			
55SSG-3	0.44	11	6	152
55SSG-4	0.55	14	6	152
55SSG-5	0.61	15	6	152
55SSG-6	0.68	17	6	152
55SSG-8	0.83	21	6	152
55SSG-12	1.09	28	7	178

Special configurations available upon request.
Contact factory.

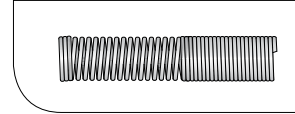

For CNG Hose (Stainless Steel)

Part Number	Hose Max. O.D.		Standard Length	
	inch	mm	inch	mm
#	⊙			
3PSG-3	0.46	12	5.30	135
3PSG-4	0.54	14	6.25	159
5PSG-4	0.57	14	6.25	159
5PSG-6	0.68	17	6.50	165
5PSG-8	0.90	23	6.50	165

SG - Steel Spring Guards (Plated, hard-drawn steel wire)

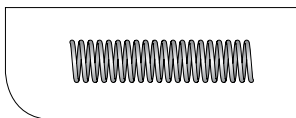

Part Number	Hose O.D. (reference)		Standard Length	
	inch	mm	feet	mtr.
#	⊙			
55SG-3	0.47	12	25	7.6
55SG-4	0.55	14	25	7.6
55SG-5	0.61	16	25	7.6
55SG-6	0.67	17	25	7.6
55SG-8	0.83	21	25	7.6
55SG-12	1.09	28	10	3
55SG-16	1.35	34	10	3
58SG-12	1.18	30	10	3
58SG-16	1.51	38	10	3

AG - Flat Steel Armor Guards

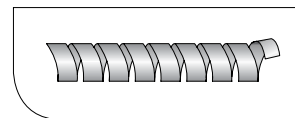

Part Number	Guard I.D.		Standard Length	
	inch	mm	feet	mtr.
#	⊙			
55AG-3	0.47	12	25	7.6
55AG-4	0.55	14	25	7.6
55AG-5	0.61	16	25	7.6
55AG-6	0.67	17	25	7.6
55AG-8	0.83	21	25	7.6
55AG-12	1.09	28	10	3
55AG-16	1.35	34	10	3
58AG-12	1.18	30	10	3
58AG-16	1.51	38	10	3

For detailed ordering information, please consult price list or contact Parflex® Division.

Parker Hannifin Corporation | Parflex® Division | Ravenna, Ohio | parker.com/pfd

www.comoso.com



A Hose
 B Tubing
 C Coiled Air Hose & Fittings
 D Transportation
 E Fittings
 F Tooling, Equipment & Accessories
 G General Technical

Guards for PTFE Hoses



AS



2625, 2799

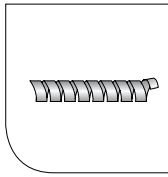

2740, 2613



FS

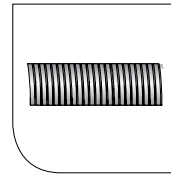

MG

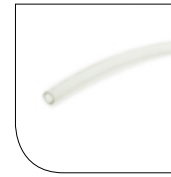

PV

Hose		Max. O.D.	Partek Sleeve	External Round Spring	Internal Round Spring	External Flat Spring	Internal Flat Spring	Fire Sleeve	External Anti-Kink Casing	Clear Vinyl Sleeve
919/929	-3	0.25	-	2625-10	-	2740-10	-	-	-	PV75-1
	-4	0.32	-	2625-11	-	2740-11	-	FS-F-5	MG-038-015C	PV86-1
	-5	0.40	-	2625-14	-	2740-14	-	FS-F-7	MG-044-015C	PV97-1
	-6	0.46	AS-Y-11/AS-B-11	2625-15	-	2740-16	-	FS-F-8	MG-050-015C	PV108-1
	-8	0.56	AS-Y-11/AS-B-11	2625-19	-	2740-19	2613-13CR	FS-F-10	MG-062-015C	PV1310-1
	-10	0.66	AS-Y-13/AS-B-13	2625-22	-	2740-22	2613-16CR	FS-F-12	MG-075-015C	PV1411-1
	-12	0.79	AS-Y-15/AS-B-15	2625-26	-	2740-26	2613-20CR	FS-F-14	MG-081-015C	PV1814-1
	-16	1.05	AS-Y-17/AS-B-17	2625-34	-	2740-34	2613-28CR	FS-F-20	MG-112-015C*	PV2218-1
	-20	1.32	AS-Y-22/AS-B-22	2625-44	-	2740-44	2613-37CR	FS-F-24	MG-144-015C	-
939	-4	0.48	AS-Y-11/AS-B-11	2625-16	-	2740-18	-	FS-F-10	-	-
	-6	0.59	AS-Y-13/AS-B-13	2625-20	-	2740-20	-	FS-F-11	-	-
	-8	0.75	AS-Y-15/AS-B-15	2625-25	-	2740-25	-	FS-F-14	-	-
	-10	0.88	AS-Y-17/AS-B-17	2625-29	-	2740-30	-	FS-F-16	-	-
	-12	1.09	AS-Y-19/AS-B-19	2625-36	-	2740-36	-	FS-F-20	-	-
	-16	1.33	AS-Y-27/AS-B-27	2625-44	2799-16CR	2740-44	-	FS-F-24	-	-
	-20	1.75	AS-Y-35/AS-B-35	2625-58	2799-20CR	2740-58	-	FS-F-32	-	-
	-24	2.05	AS-Y-39/AS-B-39	2625-67	2799-24CR	2740-70	-	FS-F-38	-	-
	-32	2.56	AS-Y-47/AS-B-47	2625-83	2799-32CR	2740-83	-	FS-F-48	-	-
943	-6	0.49	AS-Y-11/AS-B-11	2625-17	-	2740-18	-	FS-F-10	-	-
	-8	0.62	AS-Y-13/AS-B-13	2625-21	-	2740-21	2613-13CR	FS-F-11	-	-
	-10	0.73	AS-Y-15/AS-B-15	2625-24	-	2740-23	2613-16CR	FS-F-14	-	-
	-12	0.99	AS-Y-17/AS-B-17	2625-33	-	2740-35	2613-20CR	FS-F-18	-	-
	-16	1.39	AS-Y-27/AS-B-27	2625-45	-	2740-46	2613-28CR	FS-F-24	-	-

NOTE: *MG-112-015C to be used on 919-16 only.
Partek sleeves come in yellow and black.
All internal guards are fabricated from 300 series stainless steel.
All external guards are plated steel.



For detailed ordering information, please consult price list or contact Parflex® Division.

Spring Guards & Armor Guards

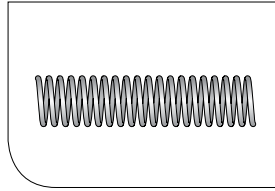
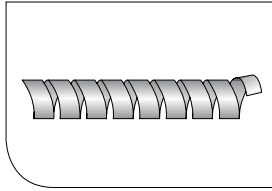

Hose Style	Armor Guards/Spring Guards								
	55AG-3 55SG-3	55AG-4 55SG-4	55AG-5 55SG-5	55AG-6 55SG-6	55AG-8 55SG-8	55AG-12 55SG-12	55AG-16 55SG-16	58AG-12 58SG-12	58AG-16 58SG-16
510A/510C/518C/518D	-2,-3	-4	-5	-6	-8		-16	-12	
515H	-3,-4	-5	-6		-8				
520N/528N	-3	-4	-5	-6	-8	-10			
526BA	-3	-4		-6					
527BA	-3		-4						
53DM/538DM	-3	-4		-5	-6	-8,-10		-12	
540N/540P/540R	-2,-3	-4	-5	-6	-8	-12			
55LT	-2,-3	-4	-5	-6	-8	-12			
560/560R	-3	-4	-5	-6	-8	-10		-12	
563		-4		-6	-8				
56DH/568DH	1.5,-2								
569			-4						
573X	-3								
575X	-3	-4		-6	-8			-12	
580N/H580N/588N				-4	-6	-8,-10		-12	-16
590		-3	-4	-6	-8	-10		-12	-16
593								-12	-16
83FR		-4		-6	-8	-12			
1035A		-4		-6					
1035HT	-3	-4		-6					
B9	-3	-4	-5	-6	-8	-10			
D6			-4	-5	-6	-8,-10	-12		-16
D6R		-4	-5	-6	-8	-10	-12		
H6		-4	-5	-6	-8	-10	-12		
HFS			-4	-5	-6			-12	-16
HFSR		-4	-5	-6	-8	-12	-16		
HFS2			-4		-6	-8,-10		-12	-16
HFS2R			-4	-6	-8			-12	-16
HJK				-4					
HLB	-2,-3								
HTB/M8				-4	-6	-8,-10	-12		-16
HTBR			-4		-6	-8,-10			
MSH		-5		-6					
PTH	-3								
R6			-4		-6	-8		-12	
S5N					-8				
S6/S9							-12		-16
SLH					-8				

For detailed ordering information, please consult price list or contact Parflex® Division.

Parker Hannifin Corporation | Parflex® Division | Ravenna, Ohio | parker.com/pfd

www.comoso.com



PVC Guards



Hose Style	PVC Guards						
	PV97-1	PV139-1	PV1611-1	PV2014-1	PV2218-1	PV2420-1	PV3224-1
510A/510C/518C/518D	-2	-3	-4,-5,-6	-8	-10	-12	-16
515H	-3		-5,-6				
520N/528N		-3	-4,-5	-6,-8	-10		
526BA		-3	-4	-6			
527BA		-3	-4				
53DM/538DM		-3	-4,-5	-6	-8,-10	-12	
540N/540P/540R	-2	-3	-4,-5	-6,-8	-12		
55LT		-3	-4,-5	-6,-8		-12	
560/560R		-3	-4,-5,-6	-8	-10	-12	
563			-4	-6,-8			
56DH/568DH	-1.5, -2						
569			-4				
573X		-3					
575X		-3	-4	-6,-8		-12	
580N/H580N/588N					-8,-10	-12	
590		-3	-4	-6,-8	-10	-12	-16
593						-12	-16
83FR			-4,-6	-8	-12		
1035A			-4	-6			
1035HT		-3	-4	-6			
B9	-3		-4,-5,-6		-10		
D6			-4,-5	-6,-8	-10	-12	
D6R			-4,-5,-6	-8	-10	-12	
H6			-4,-5	-6,-8	-10	-12	
HFS			-4,-5	-6,-8	-12		-16
HFSR			-4,-5,-6	-8	-12		-16
HFS2			-4	-6,-8	-10	-12	-16
HFS2R			-4,-6	-8	-10,-12		-16
HJK			-4				
HLB		-3					
HTB/M8			-4	-6	-8,-10	-12	
HTBR			-4	-6	-8,-10	-12	
MSH			-5,-6				
PTH		-3					
R6			-4	-6	-8	-10	-12
S5N				-8			
S6/S9						-12	-16
SLH				-8	-10	-12	-16



For detailed ordering information, please consult price list or contact Parflex® Division.

PSG – Parker Spiral Guard



Features

- High-strength and resilient, Spiral Guard protects hose and cable with superior anti-crush performance
- Exceptionally smooth facing and rounded edges prevent Spiral Guard from getting caught on rough surfaces
- Easy installation and routing
- Low friction interior minimizes wear on hose
- For bundling, organizing and protecting hose and cable, Parflex Spiral Guard is the superior solution for mining operations - In fact, it delivers more advantages than cut pipe or sleeving at a competitive price or less
- Spiral Guard is available in:
 - An MSHA/FRAS approved version for underground mining
 - A standard version (with yellow stripe) for surface applications not requiring fire-resistant, anti-static properties

Applications



- Mining
- Automotive
- Mobile Equipment

Part Number	Hose O.D. Range		Package Qty.		1-Wire Braid Size		2-Wire Braid Size		Multi-Spiral Size		Weight	
	mm	inch	mtr.	feet	inch	mm	inch	mm	inch	mm	lbs./ft.	kg./mtr.
#	◎										lbs	kg
PSG 12	10 – 13	.394-.512	20	65.6	-		-		-		.034	.015
PSG 16 FRAS or PSG 16	12 – 17	.472-.669	20	65.6	1/4	6	1/4	6	-		.040	.018
PSG 20 FRAS or PSG 20	16 – 22	.630-.866	20	65.6	3/8	10	1/4 3/8	6 10	3/8	10	.060	.027
PSG 25 FRAS or PSG 25	22 – 28	.866-1.10	20	65.6	1/2 5/8	13 16	1/2 5/8	13 16	1/2 5/8	13 16	.101	.046
PSG 32 FRAS or PSG 32	27 – 33	1.06-1.30	20	65.6	3/4	19	5/8 3/4	16 19	5/8 3/4	16 19	.151	.068
PSG 40 FRAS or PSG 40	33 – 42	1.30-1.65	20	65.6	1	25	1	25	1	25	.235	.107
PSG 50 FRAS or PSG 50	42 – 55	1.65-2.17	20	65.6	1-1/4 1-1/2	32 38	1-1/4	32	1-1/4	32	.268	.122
PSG 63 FRAS or PSG 63	52 – 65	2.05-2.56	20	65.6	2	51	1-1/2	38	1-1/2	38	.402	.182
PSG 75 FRAS or PSG 75	65 – 80	2.56-3.15	10	32.8	-		2	51	2	51	.637	.289
PSG 90 FRAS or PSG 90	80 – 150	3.15-5.91	10	32.8	-		-		-		.771	.350
PSG 110 FRAS or PSG 110	150 – above	5.91-above	10	32.8	-		-		-		1.00	.454

Temperature Range: -148°F to 212°F (-100°C to 100°C)

For detailed ordering information, please consult price list or contact Parflex® Division.

Parker Hannifin Corporation | Parflex® Division | Ravenna, Ohio | parker.com/pfd

www.comoso.com



General Technical

Hose Assembly Instructions

Hose Selection, Installation
& Maintenance

Die Selection & Crimp Charts

Materials

Government Agency
& Specifications



Table of Contents

Hose Selection, Installation & Maintenance

Intro	G-4
Selection of Hose Diameter.....	G-5
Calculation of Hose Length.....	G-6
Volumetric Expansion of Hose	G-7
Hose Permeation Data (510/510A).....	G-8
Pressure Rating of Hose End Connections.....	G-9
Selection, Installation & Maintenance	G-10

Hose Assembly & Crimping Instructions

How To Use Crimpsource	G-13
Permanent Crimp, Series 56	G-14
MiniKrimp™ Assembly, Series 56	G-17
Permanent Crimp, Series 54, 55, 58, 58H, 92, CY, HY, LV, MS, SF.....	G-20
MiniKrimp™ Assembly	G-23
Field Attachable, Series 51, BU & MS.....	G-26
PTFE Permanent Crimp, Series 91, 91N & 93N.....	G-28
PTFE Permanent Crimp, Series PAGE.....	G-31
PTFE Field Attachable, Series 90.....	G-33
Sewer Hose SQ-Swage Assembly Instructions.....	G-36
Twin/Multi-Line Separation.....	G-39



Technical Data

Ferrul-Fix Installation Instructions	G-41
Die Selection & Swage Specification Chart (Sewer Hose)	G-42
Hose Fitting Insertion Values	G-43
Hose Fitting Thread Guide	G-44
Media to Fitting & Seal Compatibility Guide	G-45
Metal Tube & Fitting Material Compatibility Guide	G-47
O-Ring Material Selection Guide	G-49
Metals Corrosion Scale	G-50
Materials to Parflex Part Number	G-51
Media to Hose Material Compatibility Guide	G-52
Media to Plastic Tubing Material Compatibility Guide	G-56
Metric Conversion Chart	G-59

Other

Government Agency & Specifications	G-60
Parker Safety Guide	G-61
ENERPAC Warranty	G-65
Offer of Sale	G-66
Part Number Index	i
Key Word Index	v

Hose
A

Tubing
B

Coiled Air Hose
& Fittings
C

Transportation
D

Fittings
E

Tooling, Equipment
& Accessories
F

General Technical
G

For detailed ordering information, please consult price list or contact Parflex® Division.

Parker Hannifin Corporation | Parflex® Division | Ravenna, Ohio | parker.com/pfd

www.comoso.com



G-3

General Technical Introduction

B Tubing

Hose Assembly Tutorial

Crimping

- **Steps for crimping** are clearly marked with sequences showing product distinctions between products lines.
 - Crimping section, as well as universal preparations, for all hoses appear first. The new, global 56 series fitting assembly instructions are segmented on pages **G:13-G:16**. Segmented instructions have also been added for the PAGE hose product line on pages **G:13-G:16**.
 - Field attachable assemblies appear next

C Coiled Air Hose & Fittings

Twin/Multi-Line Hose

- Review **twin/multi-line hose separation**, pg. G-39 if applicable – this will give you information before proceeding to the assembly pages – Not following this procedure may cause permanent damage to hoses.

D Transportation

*The PARKRIMP crimping system is the same for all standard Parker portable or bench style crimpers.

Please note: You must become familiar with your own specific crimper to determine its operational features. Please review thoroughly and understand your operator's manual included with your machine. Never use a crimper beyond its recommended published capacities. Crimp specifications can be found in this catalog and online by accessing Crimp Source. www.parker.com/crimpsource

F Fittings

F Tooling, Equipment & Accessories

G General Technical



Selection of Hose Diameter

From Flow Rate and Velocity

The Fluid Velocity Nomogram gives the velocity of a liquid as a function of flow rate and inside diameter of the fluid line. The commonly recommended maximum velocities for hydraulic oil systems at 200°F or less are indicated for guidance.

Example: At 10 gpm, what is the minimum size within the recommended velocity range for a hydraulic pressure line?

The dashed line drawn from the 10 gpm mark on the left hand line to the maximum velocity of 20 fps intersects the middle line at .438" (7/16" I. D. hose or tubing). For a hose application, use 1/2" I. D., the nearest common standard size.

This chart is based on the following formulas:

$$v_{\text{fps}} = \frac{.321Q}{\frac{bd^2}{4}}$$

Q = gal per min
d = hose or tube I. D. (inch)

$$\text{cu. ft./min.} = .1337 Q$$

The cu. ft. per min. value is the actual volume flow rate under flowing conditions. For air, standard cfm of free air = 7.81 actual cfm when the inlet air is at 100 psig, 68°F.

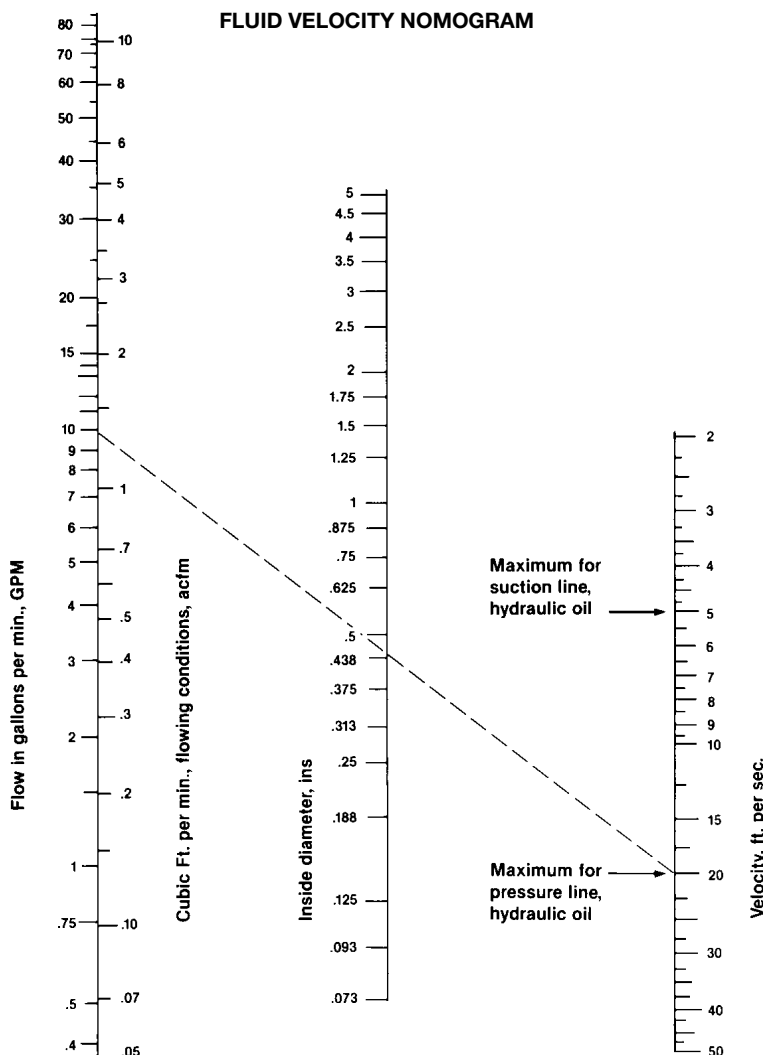

For detailed ordering information, please consult price list or contact Parflex® Division.

Parker Hannifin Corporation | Parflex® Division | Ravenna, Ohio | parker.com/pfd

www.comoso.com



Calculation of Hose Length

For Over-the-Sheave Applications

The exact cutoff length for an optimum over-the-sheave assembly depends on the particular mechanical arrangement of the machine. A method for finding an approximate starting point is as follows:

1. Assemble hose with one coupling as shown in diagram.
2. Measure hose length from point 1 to point 2 with hose taut (.985 accounts for 1.56 stretch).
LO = length
3. Calculation of insert allowance (x) may be found from the coupling dimension tabulations in the fittings section or from direct measurement on the coupling. A 1.5% stretch allowance is provided in this formula.
4. Calculate hose cutoff or free length LF:

$$LF = 0.985 LO + 2x$$
 Where LF includes coupling, insert allowance on both ends.
5. Couple the remaining hose end, check crimp, and assemble on the machine.

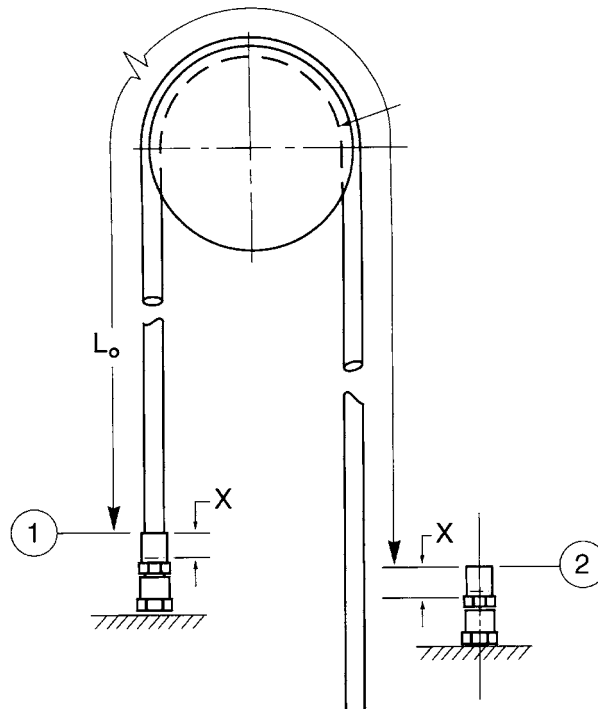

Volumetric Expansion of Hose

Hydraulic hoses expand under pressure. On some applications, customers can use the differences in expansion between hoses to tune systems for better performance or even noise reduction. Parflex has tested a select list of hoses and determined the rate of expansion in cubic centimeters per foot of hose (cc/ft).

To calculate the volumetric expansion of a hose, substitute the desired pressure into the "X" values in the appropriate equation. For other hoses, please contact the division.

Hose Part Number	Volumetric Expansion at Maximum Working Pressure		Equation for Volumetric Expansion
	(psi)	(cc/ft)	Y=(cc/ft) X=(psi)
510C-3/518C-3	3250	2.33	Y=0.0007X+0.0581
510C-4/518C-4	3000	2.71	Y=0.0009X+0.0059
510C-5/518C-5	2500	3.41	Y=0.0013X+0.1647
510C-6/518C-6	2250	4.32	Y=0.0019X+0.0471
510C-8/518C-8	2250	7.36	Y=0.0032X+0.1637
510C-12/518C-12	1250	8.99	Y = 0.00745x - 0.29910
510C-16/518C-16	1000	15.33	Y = 0.01573x - 0.44928
520N-3/528N-3	5000	1.13	Y = 0.0002x + 0.1621
520N-4/528N-4	5000	2.05	Y = 0.00031x + 0.47589
520N-5/528N-5	4500	2.63	Y = 0.00048x + 0.48415
520N-6/528N-6	4000	2.87	Y = 0.00053x + 0.75151
520N-8/528N-8	3500	3.64	Y = 0.00086x + 0.64994
520N-10/528N-10	2750	4.25	Y = 0.001x + 1.505
53DM-3/538DM-3	3000	1.36	Y = 0.00039x + 0.13035
53DM-4/538DM-4	3000	1.90	Y = 0.00062x + 0.02373
53DM-5/538DM-5	3000	2.78	Y = 0.0009x + 0.0403
53DM-6/538DM-6	3000	3.19	Y = 0.0010x + 0.0647
53DM-8/538DM-8	3000	4.68	Y = 0.0016x + 0.0384
53DM-10/538DM-10	3000	9.82	Y = 0.0033x - 0.2254
540N-2/548N-2	3000	1.11	Y = 0.00036x + 0.04607
540N-3/548N-3	3000	1.75	Y = 0.00057x + 0.03059
540N-4/548N-4	2750	2.33	Y = 0.00079x + 0.14354
540N-5/548N-5	2500	3.46	Y = 0.00124x + 0.31870
540N-6/548N-6	2250	4.06	Y = 0.00174x + 0.15045
540N-8/548N-8	2000	6.05	Y = 0.0030x + 0.0928
540N-12/548N-12	1250	10.26	Y = 0.0081x - 0.2671
560-3	3500	0.575	Y = 0.00017x + 0.00875
560-4	3250	0.757	Y = 0.0002x + 0.1172
560-5	3000	0.729	Y = 0.00021x + 0.09887
560-6	2750	1.33	Y = 0.0004x + 0.1918
560-8	2500	1.98	Y = 0.0007x + 0.2093
560-10	2000	3.04	Y = 0.0012x + 0.5704

Hose Part Number	Volumetric Expansion at Maximum Working Pressure		Equation for Volumetric Expansion
	(psi)	(cc/ft)	Y=(cc/ft) X=(psi)
575X-3	5000	1.69	Y = 0.0003x + 0.2119
575X-4	5000	2.05	Y = 0.0003x + 0.5601
575X-6	5000	2.71	Y = 0.0004x + 0.8412
575X-8	5000	4.59	Y = 0.00064x + 1.41795
575X-12	5000	12.52	Y = 0.00192x + 2.92038
575X-16	5000	16.81	Y = 0.0028x + 2.9560
590-3	5000	0.646	Y = 0.00013x + 0.01692
590-4	5000	0.888	Y = 0.00016x + 0.09821
590-6	4000	1.87	Y = 0.00038x + 0.32317
590-8	3500	2.17	Y = 0.00049x + 0.43765
590-10	3000	3.69	Y = 0.00095x + 0.82449
590-12	2500	4.20	Y = 0.0013x + 0.8216
590-16	2000	6.21	Y = 0.0026x + 1.0558
D604	3000	1.80	Y = 0.00044x + 0.51607
D606	3000	2.00	Y = 0.0006x + 0.2892
D608	3000	2.88	Y = 0.00057x + 1.20744
D610	3000	2.08	Y = 0.00061x + 0.23127
D612	3000	5.53	Y = 0.00142x + 1.21743
D616	3000	7.33	Y = 0.00205x + 1.24905
H604	3000	1.80	Y = 0.00044x + 0.51607
H605	3000	1.35	Y = 0.00036x + 0.26536
H606	3000	2.00	Y = 0.0006x + 0.2892
H608	3000	2.88	Y = 0.00057x + 1.20744
H610	3000	2.08	Y = 0.00061x + 0.23127
H612	3000	5.53	Y = 0.00142x + 1.21743

The actual volumetric expansion achieved is influenced by multiple variables including fluid properties, hose routing and application temperature. The volumetric expansion calculation is only a general guideline and must be verified by actual testing in the end-use application. No performance warranty in design is expressed or implied by this calculation. Parker recommends that the user review and understand all the precautions listed in the Parker Safety Guide for Selecting and Using Hose, Fittings and Accessories, bulletin BUL. 4400-b.1.

For detailed ordering information, please consult price list or contact Parflex® Division.

Parker Hannifin Corporation | Parflex® Division | Ravenna, Ohio | parker.com/pfd

www.comoso.com



Hose Permeation Data (510A)

Permeation Rate at 120°F (Pound per Linear Hose Foot per Year)

Hose Size	R12	R22	R507	R404A	R502	R134A
-2	-	.28	-	-	.03	-
-3	-	.30	.08	.07	-	-
-4	-	.71	.15	.10	-	-
-6	-	1.11	-	-	.87	-

Permeation Rate at 212°F (Pound per Linear Hose Foot per Year)

Hose Size	R12	R22	R507	R404A	R502	R134A
-2	-	-	-	-	-	-
-3	-	1.25	-	-	-	-
-4	.08	2.32	-	-	-	.07
-6	-	-	-	-	-	-

Notes:

1. Data is for comparison only. Actual results may vary due to differences in application temperature and pressure.
2. Data is collected in highly controlled tests per UL1963.
3. Parker Safety Guide for Selecting and Using Hose, Tubing, Fittings and Related Accessories, Section 2.6:

Permeation: Permeation (that is, seepage through the Hose) will occur from inside the Hose to outside when Hose is used with gases, liquid and gas fuels, and refrigerants (including but not limited to such materials as helium, diesel fuel, gasoline, natural gas, or LPG). This permeation may result in high concentrations of vapors which are potentially flammable, explosive, or toxic, and in loss of fluid. Dangerous explosions, fires, and other hazards can result when using the wrong Hose for such applications.

The system designer must take into account the fact that this permeation will take place and must not use Hose if this permeation could be hazardous. The system designer must take into account all legal, government, insurance, or any other special regulations which govern the use of fuels and refrigerants. Never use a Hose even though the fluid compatibility is acceptable without considering the potential hazardous effects that can result from permeation through the Hose Assembly.

Permeation of moisture from outside the Hose to inside the Hose will also occur in Hose assemblies, regardless of internal pressure. If this moisture permeation would have detrimental effects (particularly, but not limited to refrigeration and air conditioning systems), incorporation of sufficient drying capacity in the system or other appropriate system safeguards should be selected and used.

Pressure Rating of Hose End Connections

The maximum dynamic working pressure of the hose assembly is the lesser of the rated working pressure of the hose and the end connections used.

PRESSURE RATINGS HOSE ASSEMBLIES - psi

PRESSURE OF THE HOSE AND THE END CONNECTIONS USED

Hose End Connection Description	Part Number Codes	Inch Size Fittings (psi)													
		-2	-4	-5	-6	-8	-10	-12	-16	-20	-24	-32	-40	-48	-64
Hose End	Part	Inch Size Fittings													
Male Pipe (NPTF)	01	12,000	12,000		10,000	10,000		7,500	6,500	5,000	3,000	2,500			
Female Pipe (NPTF, NPSM)	02 & 07	7,500	7,000		6,000	5,000		4,000	3,000	2,500	2,000	2,000			
Male Pipe (BSP)	91 & D9	5,000	9,000		8,000	6,250		5,000	4,000	3,500	3,000	3,000			
Female Pipe (BSP)	92, B1, B2 & B4	5,000	9,000		8,000	6,250	5,500	5,000	4,000	3,500	3,000	3,000			
Female Pipe (JIS)	FU, GU, MU & UT		5,000		5,000	5,000		4,000	3,000	2,500	1,500	1,500			
O-Ring Swivel and 45° Flare	13, 1L, S2, 0G, 0L, 48, 08, 77 & 79		3,000	3,000	3,000	3,000	2,750	2,250	2,000	1,625	1,250	1,125			
37° Flare and Straight Thread	03, 05, 06, 37, 39, 41, L7 & L9		6,000	6,000	5,000	5,000	5,000	5,000	4,000	3,000	2,500	2,500			
Flare	04														
SAE Flareless	TU & AL		6,000	6,000	5,600	5,600	4,200	4,200	3,500	3,500	3,000	3,000			
SAE Inverted Flare	28, 67 & 69		2,750	2,500	2,250	2,000									
Seal-Lok®* (O-Ring Face Seal)	JM, JC, JS, J0, J1, J5, J7 & J9		6,000		6,000	6,000	6,000	6,000	6,000	4,000	4,000				
Specialty	TU, AL		6,000	6,000	5,600	5,600	4,200	4,200	3,500	3,500	3,000	3,000			

Hose End Connection	Part Number Codes	Metric Fittings (psi)															
		-6	-8	-10	-12	-14	-15	-16	-18	-20	-22	-25	-28	-30	-35	-38	-42
DIN Light "L" without O-Ring	C3, C4, C5 & 1D	3,500	3,500	3,500	3,500		3,500		2,250		2,250		1,400		1,400		1,400
DIN Light "L" with O-Ring	D0, CA, CE & CF	4,500	4,500	4,500	4,500		4,500		2,250		2,250		2,250		2,250		2,250
DIN Heavy "S" without O-Ring	C6, C7, C8 & 3D		9,000	9,000	9,000	9,000		5,750		5,750		5,750		3,500		3,500	
DIN Heavy "S" with O-Ring	C9, 0C, 1C & D2		9,000	9,000	9,000	9,000		6,000		6,000		6,000		6,000		4,500	

NOTE: All the above ratings are based on low carbon steel hose fittings. Higher pressure ratings can be attained with medium carbon and alloy steel hose fittings and mating adapters.

PRESSURE RATING OF HOSE - psi

THE MAXIMUM WORKING PRESSURES OF HOSES ARE LISTED ON PAGE A-10 : A-17 WITH EACH HOSE DESCRIPTION IN SECTION A.

For detailed ordering information, please consult price list or contact Parflex® Division.

Parker Hannifin Corporation | Parflex® Division | Ravenna, Ohio | parker.com/pfd

www.comoso.com



Selection, Installation & Maintenance

Recommended Practices for Hydraulic Hose Assemblies

wrong

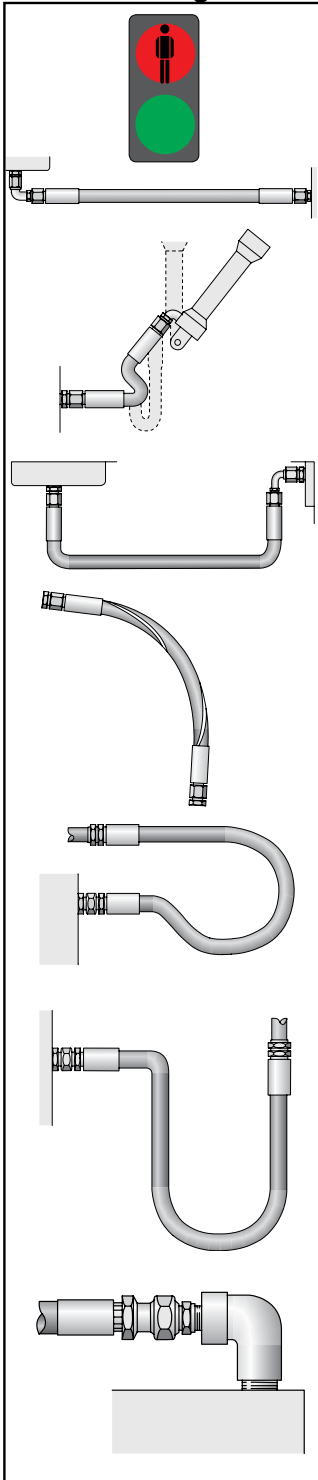

The routing of the hose assembly and the environment in which the hose assembly operates directly influence the service life of the hose assembly. The following diagrams indicate the correct routing of hose assemblies that will maximize its service life and assure a safe working functionality.

When hose installation is straight, there must be enough slack in the hose to allow for changes in length that occur when pressure is applied. When pressurized, hose that is too short may pull loose from its hose fittings or stress the hose fitting connections, causing premature metallic or seal failures.

The hose length must be determined so that the hose assembly has enough slack to allow the system components to move or vibrate without creating tension in the hose.

However, do not allow too much slack and therefore introduce the risk of the hose snagging on other equipment or rubbing on other components.

Mechanical straining of the hoses needs to be avoided, so the hose must not be bent below its minimum bend radius or twisted during installation. The minimum bending radii for each hose is stated in the hose tables in the catalogue.

The plane of movement must also be considered and the hose routing selected accordingly.

Hose routing also plays an important role on the selection of the hose fittings, as the correct fittings can avoid straining the hoses, unnecessary hose length or multiple threaded joints.

right

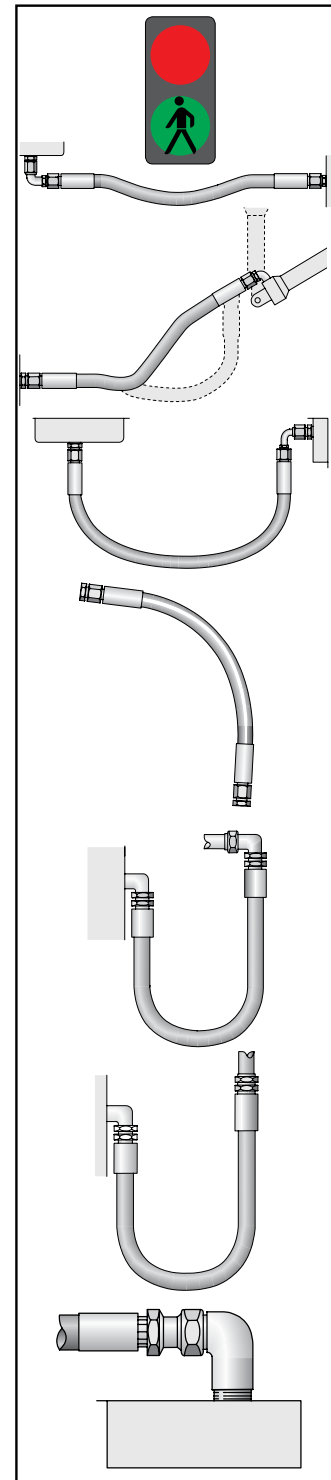

wrong

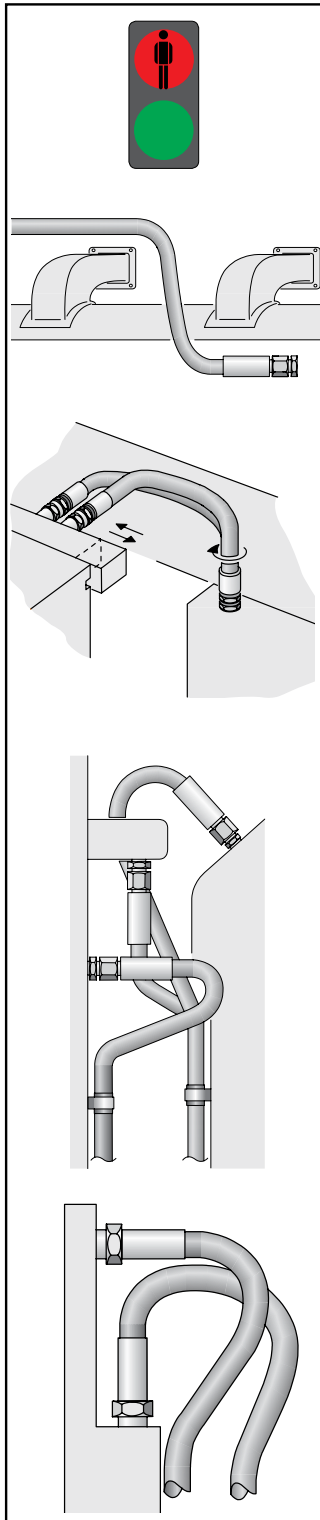

Correct clamping (holding/supporting) of the hose should be exercised to securely route the hose or to avoid the hose contacting surfaces that will cause the hose damage. It is however, vital that the hose be allowed to keep its functionality as a “flexible-pipe” and not be restricted from changing in length when under pressure.

It should also be noted that hoses for high- and low-pressure lines shall not be crossed or clamped together, as the difference in changes in length could wear the hose covers.

Hose should not be bent in more than one plane. If hose follows a compound bend, it shall be coupled into separate segments or clamped into segments that each flex in only one plane.

Hoses should be kept away from hot parts as high ambient temperatures shorten hose life.

Protective insulation may need to be used in unusually high ambient temperature areas.

While the importance of the functionality is primary, the aesthetics and practicality of the installation should also be considered in the design.

Maintenance might be necessary at some point in the future, so prohibitive design routings should be avoided.

right

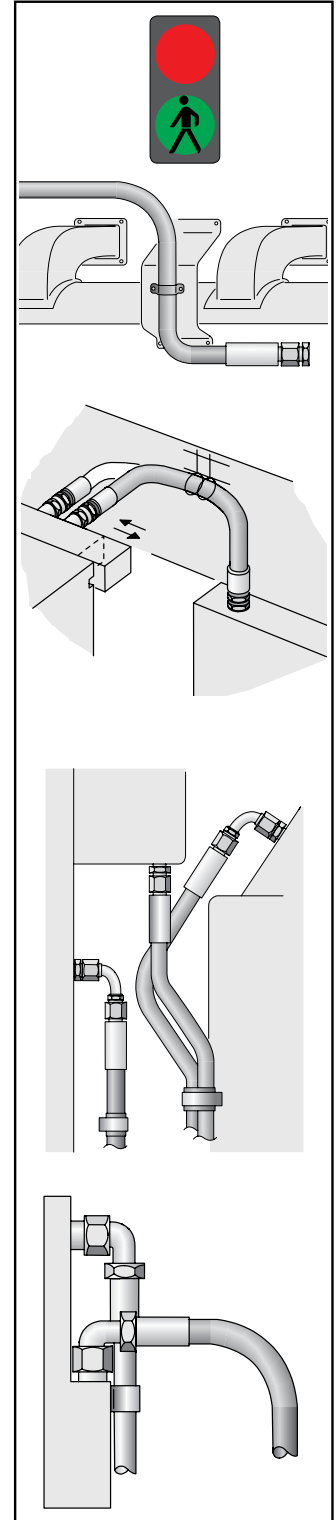

Selection, Installation & Maintenance (cont.)

Recommended Practices for Hydraulic Hose Assemblies

wrong

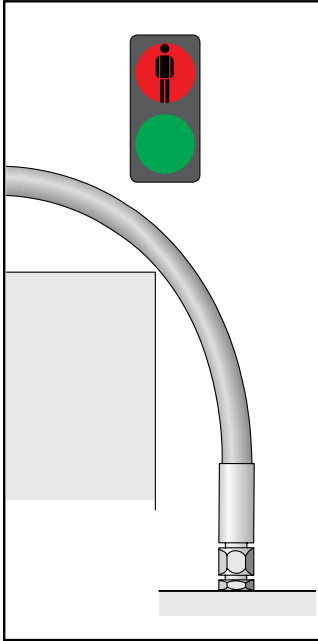

Abrasive influences

In general care should be taken so that the hose is not exposed to direct surface contact that will cause abrasive wearing of the outer cover (either hose to object or hose to hose contact). If however, the application is such that this cannot be avoided, either a hose with a higher abrasion resistant hose cover or a protective sleeve need to be used.

right

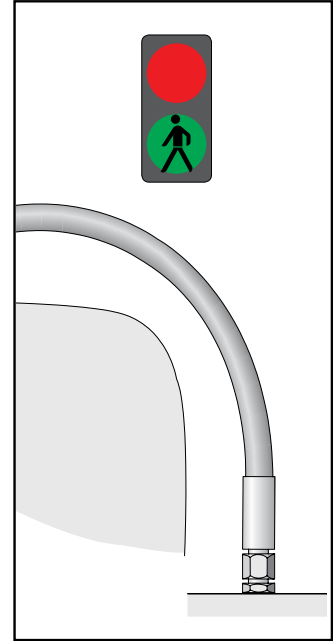

Hose Assembly and Crimping

How To Use Crimpsource

1

Data



The most **up-to-date** information for crimping is located at www.parker.com/crimpsource. Not only is it accurate, but it is easy.

NOTE: If the hose does not come up, then you cannot crimp that hose on the machine you selected.

If the fitting you choose doesn't come up, then that series is not available for that hose. Same with size.

2

Make your Selections

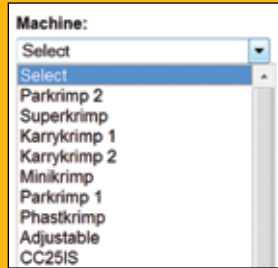

Choose the correct machine.

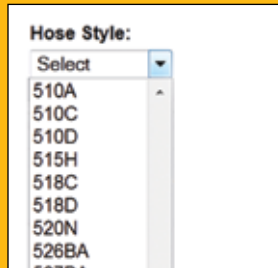

Choose the hose you are crimping.

Note If the hose does not come up, then the crimper chosen does not work with the selected hose.

3

Make your Selections

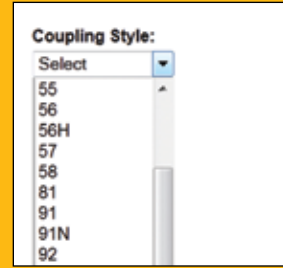

Choose the fitting style.

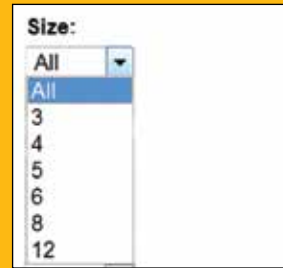

Choose the fittings size. Once you have selected values from each field, hit the search button.

Note If the chosen fitting/size doesn't come up, the series/size is not available for that hose.

4

Review The Results

Home Print

Hose Style: **540N** Coupling Style: **56** Crimper: **Minikrimp** Hose Description: **Meets or exceeds SAE 100R7**

Size	Die	Die Ring	Crimp Diameter	Crimp Length	Hose Insertion	Drawing
Parker Parflex Crimp Dies						
-8	80C-P08		82C-R01	0.850	FULL	1-1/8 PKFull

Comments

PFD: Crimp diameter is measured four places, 45 degrees apart, at the top, then middle and bottom of the crimp.

PFD: Crimp diameter tolerance on all Parkrimp Crimpers is $\pm 0.010"$ ($\pm 0.25\text{mm}$) unless otherwise specified. Crimp length tolerance is $\pm 0.030"$ ($\pm 0.76\text{mm}$).

PFD: Align measurement caliper or micrometer on the center of crimp impressions avoiding the crimp ribs.

PFD: Crimp diameter tolerance on all Adjustable Crimpers is $\pm 0.005"$ ($\pm 0.13\text{mm}$). Crimp length tolerance is $\pm 0.030"$ ($\pm 0.76\text{mm}$).

PFD: Reference Parker Fluid Connector Group (FCG) Safety Bulletin 4400-B.1 (www.parker.com/safety)

For detailed ordering information, please consult price list or contact Parflex® Division.

Parker Hannifin Corporation | Parflex® Division | Ravenna, Ohio | parker.com/pfd

www.comoso.com



G-13

A Hose

B Tubing

C Coiled Air Hose & Fittings

D Transportation

E Fittings

F Tooling, Equipment & Accessories

G General Technical

Hose Assembly and Crimping

Permanent Crimp Series 56

CAUTION: There are several different sections for Hose Assembly and Crimping. Be sure you are in the section that corresponds to the fitting series you are using. See Table of Contents for listing.

1

Inspection

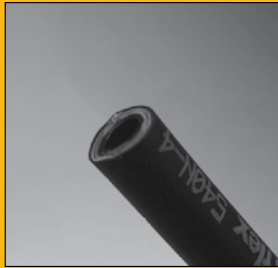

Hose – Visually inspect both ends of hose for square cut. Remove any burrs, loose fibers or wires.



Fittings – Verify fitting series corresponds to the selected hose. Visually inspect fitting(s) for a through-hole, threads and damage.

2

Assembly Prep



Insertion Depth – Shown is a 56 series fitting. Using Parflex Depth Insertion Block (part# TH9-1-56), mark the hose with the proper insertion depth line. On some fittings such as 55 Series, this depth is represented by a dashed or knurled line on the crimp shell.



Lubrication (as required) – Using an SAE 20 weight lubricating oil, lightly lubricate inside of hose end.

Warning

Do not use lubricating oil when installing fittings on hose used in oxygen service. When installing fittings on hose used in oxygen service, lubricate with a non-oil based soap solution. Failure to do so may result in an explosion and personal injury when hose is used.

3

Assembly



Assemble hose – Push hose into fitting all the way to depth insertion mark. (If fitting does not readily slide onto hose, perform the next step.)

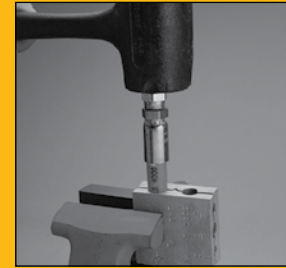

Using Parker VBS or VBL (vise blocks) and a rubber mallet, tap fitting onto hose until bottom of fitting shell is aligned with depth insertion mark.

Hose Assembly and Crimping

Permanent Crimp Series 56 (cont.)

4

Die Selection

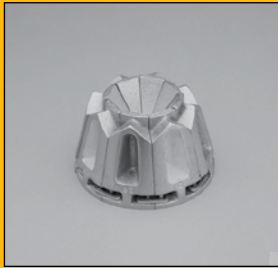

Select proper Parkrimp die set. (Reference Crimp Die Selection on Crimpsource online at www.parker.com/crimpsource)

6

Die & Spacer Ring

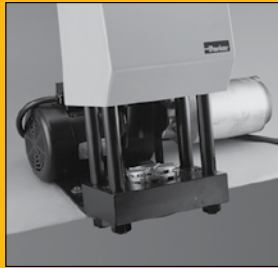

Crimp Die – Place die set into bowl.



Die Ring – Place applicable die ring on top of die. Position ring so it is centered on die.

(Reference Crimp Die Selection on Crimpsource online at www.parker.com/crimpsource)

7

Crimp



Assemble hose – Insert hose and fitting from bottom of crimper and up through die set. Position fitting so bottom of fitting skirt rests on die step (PARKALIGN® feature).

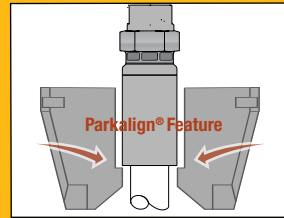

While holding hose and fitting in position on die step, crimp fitting onto hose until die ring contacts base plate.

Warning

Keep fingers and hands away from die-pusher area. Failure to do so may result in personal injury.

Note

Pump on crimper must not exceed the rated pressure of the crimper being used. Parker Hannifin will not accept responsibility for the operation of or provide warranty coverage for a crimper that is operated by a power unit other than equipment supplied by Parker Hannifin for the express purpose of operating the crimper.

5

Lubricate Bowl



Grease frequently using a premium, quality, lithium-base grease. Apply a thin layer of grease on bowl of crimper base plate.

For detailed ordering information, please consult price list or contact Parflex® Division.

Parker Hannifin Corporation | Parflex® Division | Ravenna, Ohio | parker.com/pfd

www.comoso.com



G-15

A Hose

B Tubing

C Coiled Air Hose & Fittings

D Transportation

E Fittings

F Tooling, Equipment & Accessories

G General Technical

Hose Assembly and Crimping

Permanent Crimp Series 56 (cont.)

8

Measure & Inspect



Measure and verify hose assembly length.



Inspect insertion depth mark at fitting ends. Insertion mark must be visible but not exceed 1/8" from end of crimped fitting shell.



Measure crimp diameter of each fitting at top, middle and bottom of shell. Take measurements at a minimum of three places around shell circumference. Verify crimp diameter is within tolerances.

(Reference Crimp Die Selection on Crimpsource online at www.parker.com/crimpsource)

MiniKrimp™ Fitting Assembly Procedures

Permanent Crimp Series 56

CAUTION: There are several different sections for Hose Assembly and Crimping. Be sure you are in the section that corresponds to the fitting series you are using. See Table of Contents for listing.

1

Inspection



Hose – Visually inspect both ends of hose for square cut. Remove any burrs, loose fibers or wires.



Fittings – Verify fitting series corresponds to the selected hose. Visually inspect fitting(s) for a through-hole, threads and damage.

2

Assembly Prep



Insertion Depth – Shown is a 56 series fitting. Using Parflex Depth Insertion Block (part# TH9-1-56), mark the hose with the proper insertion depth line. On some fittings such as 55 Series, this depth is represented by a dashed or knurled line on the crimp shell.



Lubrication (as required) – Using an SAE 20 weight lubricating oil, lightly lubricate inside of hose end.

Warning

Do not use lubricating oil when installing fittings on hose used in oxygen service. When installing fittings on hose used in oxygen service lubricate with a non-oil based soap solution. Failure to do so may result in an explosion and personal injury when hose is used.

3

Assembly



Assemble hose – Push hose into fitting all the way to depth insertion mark. (If fitting does not readily slide onto hose, perform the next step.)

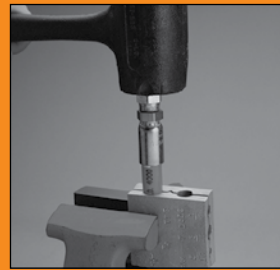

Using Parker VBS or VBL (vise blocks) and a rubber mallet, tap fitting onto hose until bottom of fitting shell is aligned with depth insertion mark.

A Hose

B Tubing

C Coiled Air Hose & Fittings

D Transportation

E Fittings

F Tooling, Equipment & Accessories

G General Technical

For detailed ordering information, please consult price list or contact Parflex® Division.

Parker Hannifin Corporation | Parflex® Division | Ravenna, Ohio | parker.com/pfd

www.comoso.com



G-17

MiniKrimp™ Fitting Assembly Procedures

Permanent Crimp Series 56 (cont.)

4

Die Selection

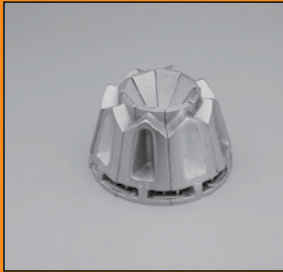

Select proper Parkrimp die set. (Reference Crimp Die Selection on Crimpsource online at www.parker.com/crimpsource)

6

Die & Spacer Ring

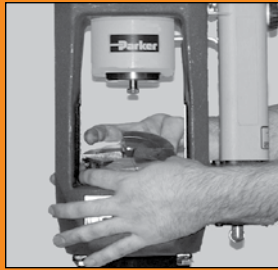

Crimp Die – Place die set into bowl.



Die Ring – Place applicable die ring on top of die. Position ring so it is centered on die.

(Reference Crimp Die Selection on Crimpsource online at www.parker.com/crimpsource)



Replace pusher onto shoulder bolt.

7

Crimp



Assemble hose – Insert hose and fitting from bottom of crimper and up through die set. Position fitting so bottom of fitting skirt rests on the step (PARKALIGN® feature).

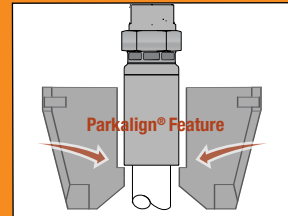

While holding hose and fitting in position on die step, crimp fitting onto hose until die ring contacts base plate.

Warning

Keep fingers and hands away from die-pusher area. Failure to do so may result in personal injury.

Note

Parker Hannifin will not accept responsibility for the operation of or provide warranty coverage for a crimper that is operated by a power unit other than equipment supplied by Parker Hannifin for the express purpose of operating the crimper.

5

Lubricate Bowl



Remove pusher from shoulder bolt.

Using a premium, quality, lithium-base grease, apply a thin layer of grease on bowl of crimper base plate.

MiniKrimp™ Fitting Assembly Procedures

Permanent Crimp Series 56 (cont.)

8

Measure & Inspect



Measure and verify hose assembly length.



Inspect insertion depth mark at fitting ends. Insertion mark must be visible but not exceed 1/8" from end of crimped fitting shell.



Measure crimp diameter of each fitting at top, middle and bottom of shell. Take measurements at a minimum of three places around shell circumference. Verify crimp diameter is within tolerances.

(Reference Crimp Die Selection on Crimpsource online at www.parker.com/crimpsource)

A Hose

B Tubing

C Coiled Air Hose & Fittings

D Transportation

E Fittings

F Tooling, Equipment & Accessories

G General Technical

For detailed ordering information, please consult price list or contact Parflex® Division.

Parker Hannifin Corporation | Parflex® Division | Ravenna, Ohio | parker.com/pfd

www.comoso.com



G-19

Hose Assembly and Crimping

Permanent Crimp

Series 54, 55, 58, 58H, 92, CY, HY, LV, MS, SF

CAUTION: There are several different sections for Hose Assembly and Crimping. Be sure you are in the section that corresponds to the fitting series you are using. See Table of Contents for listing.

1

Inspection

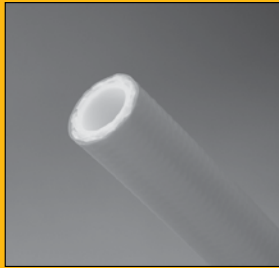

Hose – Visually inspect both ends of hose for square cut. Remove any burrs, loose fibers or wires.



Fittings – Verify fitting series corresponds to the selected hose. Visually inspect fitting(s) for a through-hole, threads and damage.

2

Assembly Prep



Insertion Depth – Shown is a 55 series fitting. See Hose Fitting Insertion Values, pg. G-43 for insertion depths of fitting series that do not incorporate an insertion depth. Mark hose end with proper insertion depth line.



Lubrication (as required) – Using an SAE 20 weight lubricating oil, lightly lubricate inside of hose end.

Warning

Do not use lubricating oil when installing fittings on hose used in oxygen service. When installing fittings on hose used in oxygen service, lubricate with a non-oil based soap solution. Failure to do so may result in an explosion and personal injury when hose is used.

3

Assembly



Assemble hose – Push hose into fitting all the way to depth insertion mark. (If fitting does not readily slide onto hose, perform the next step.)



Using Parker VBS or VBL (vise blocks) and a rubber mallet, tap fitting onto hose until bottom of fitting shell is aligned with depth insertion mark.

Hose Assembly and Crimping

Permanent Crimp (cont.)

Series 43, 54, 55, 58, 58H, 92, CY, HY, LV, MS, SF

4

Die Selection

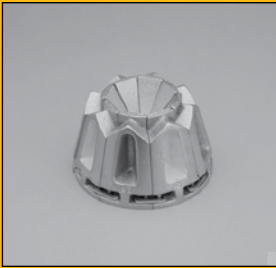

Select proper Parkrimp die set. (Reference Crimp Die Selection Charts - pg. G-13 or Crimp-source online at www.parker.com/crimpsource)

5

Lubricate Bowl



Grease frequently using a premium, quality, lithium-base grease. Apply a thin layer of grease on bowl of crimper base plate.

6

Die & Spacer Ring

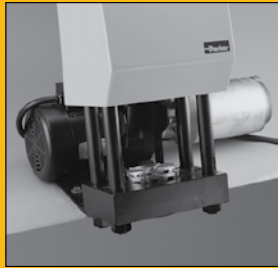

Crimp Die – Place die set into bowl.



Die Ring – Place applicable die ring on top of die. Position ring so it is centered on die.

(Reference Crimp Die Selection Charts - pg. G-13 or Crimp-source online at www.parker.com/crimpsource)

7

Crimp



Assemble hose – Insert hose and fitting from bottom of crimper and up through die set. Position fitting so bottom of fitting skirt rests on die step (PARKALIGN® feature).

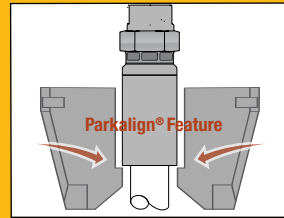

While holding hose and fitting in position on die step, crimp fitting onto hose until die ring contacts base plate.

Warning

Keep fingers and hands away from die-pusher area. Failure to do so may result in personal injury.

Note

Pump on crimper must not exceed the rated pressure of the crimper being used. Parker Hannifin will not accept responsibility for the operation of or provide warranty coverage for a crimper that is operated by a power unit other than equipment supplied by Parker Hannifin for the express purpose of operating the crimper.

For detailed ordering information, please consult price list or contact Parflex® Division.

Parker Hannifin Corporation | Parflex® Division | Ravenna, Ohio | parker.com/pfd

www.comoso.com



G-21

A Hose

B Tubing

C Coiled Air Hose & Fittings

D Transportation

E Fittings

F Tooling, Equipment & Accessories

G General Technical

Hose Assembly and Crimping

Permanent Crimp (cont.)

Series 54, 55, 58, 58H, 92, CY, HY, LV, MS, SF

8

Measure & Inspect



Measure and verify hose assembly length.



Inspect insertion depth mark at fitting ends. Insertion mark must be visible but not exceed 1/8" from end of crimped fitting shell.

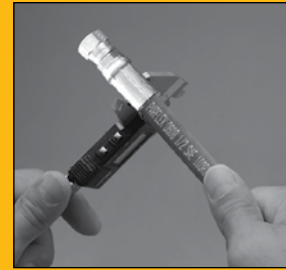

Measure crimp diameter of each fitting at top, middle and bottom of shell. Take measurements at a minimum of three places around shell circumference. Verify crimp diameter is within tolerances.

(Reference Crimp Die Selection Charts - pg. G-13 or Crimp-source online at www.parker.com/crimpsource)

MiniKrimp™ Fitting Assembly Procedures

CAUTION: There are several different sections for Hose Assembly and Crimping. Be sure you are in the section that corresponds to the fitting series you are using. See **Table of Contents** for listing.

1

Inspection

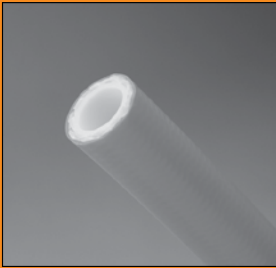

Hose – Visually inspect both ends of hose for square cut. Remove any burrs, loose fibers or wires.



Fittings – Verify fitting series corresponds to the selected hose. Visually inspect fitting(s) for a through-hole, threads and damage.

2

Assembly Prep



Insertion Depth – Mark hose end with proper insertion depth line. See Hose Fitting Insertion Values, pg. G-43 for insertion depths of fitting series that do not incorporate an insertion depth.



Lubrication (as required) – Using an SAE 20 weight lubricating oil, lightly lubricate inside of hose end.

Warning

Do not use lubricating oil when installing fittings on hose used in oxygen service. When installing fittings on hose used in oxygen service lubricate with a non-oil based soap solution. Failure to do so may result in an explosion and personal injury when hose is used.

3

Assembly



Assemble hose – Push hose into fitting all the way to depth insertion mark. (If fitting does not readily slide onto hose, perform the next step.)



Using Parker VBS or VBL (vise blocks) and a rubber mallet, tap fitting onto hose until bottom of fitting shell is aligned with depth insertion mark.

A Hose

B Tubing

C Coiled Air Hose & Fittings

D Transportation

E Fittings

F Tooling, Equipment & Accessories

G General Technical

For detailed ordering information, please consult price list or contact Parflex® Division.

Parker Hannifin Corporation | Parflex® Division | Ravenna, Ohio | parker.com/pfd

www.comoso.com



MiniKrimp™ Fitting Assembly Procedures

(cont.)

4

Die Selection

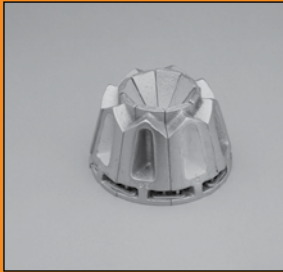

Select proper Parkrimp die set. (Reference Crimp Die Selection Charts - pg. G-13 or Crimp-source online at www.parker.com/crimpsource)

5

Lubricate Bowl



Remove pusher from shoulder bolt.

Using a premium, quality, lithium-base grease, apply a thin layer of grease on bowl of crimper base plate.

6

Die & Spacer Ring

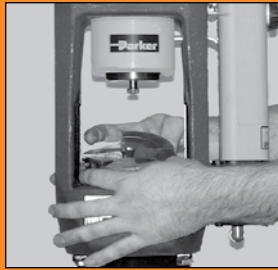

Crimp Die – Place die set into bowl.



Die Ring – Place applicable die ring on top of die. Position ring so it is centered on die.

(Reference Crimp Die Selection Charts - pg. G-13 or Crimp-source online at www.parker.com/crimpsource)



Replace pusher onto shoulder bolt.

7

Crimp



Assemble hose – Insert hose and fitting from bottom of crimper and up through die set. Position fitting so bottom of fitting skirt rests on the step (PARKALIGN® feature).

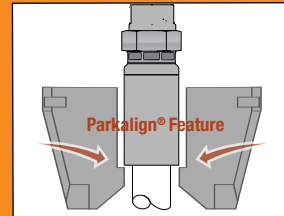

While holding hose and fitting in position on die step, crimp fitting onto hose until die ring contacts base plate.

Warning

Keep fingers and hands away from die-pusher area. Failure to do so may result in personal injury.

Note

Parker Hannifin will not accept responsibility for the operation of or provide warranty coverage for a crimper that is operated by a power unit other than equipment supplied by Parker Hannifin for the express purpose of operating the crimper.

MiniKrimp™ Fitting Assembly Procedures

(cont.)

8

Measure & Inspect



Measure and verify hose assembly length.



Inspect insertion depth mark at fitting ends. Insertion mark must be visible but not exceed 1/8" from end of crimped fitting shell.

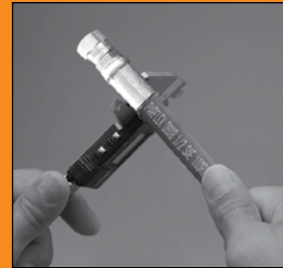

Measure crimp diameter of each fitting at top, middle and bottom of shell. Take measurements at a minimum of three places around shell circumference. Verify crimp diameter is within tolerances.

(Reference Crimp Die Selection Charts - pg. G-13 or Crimp-source online at www.parker.com/crimpsource)

A Hose

B Tubing

C Coiled Air Hose & Fittings

D Transportation

E Fittings

F Tooling, Equipment & Accessories

G General Technical

For detailed ordering information, please consult price list or contact Parflex® Division.

Parker Hannifin Corporation | Parflex® Division | Ravenna, Ohio | parker.com/pfd

www.comoso.com



Hose Assembly & Crimping

Field Attachable

Series 51, BU & MS (Do not use these fittings on oxygen service lines)

CAUTION: There are several different sections for Hose Assembly and Crimping. Be sure you are in the section that corresponds to the fitting series you are using. See **Table of Contents** for listing.

1

Inspection

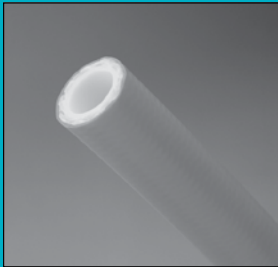

Hose – Visually inspect both ends of hose for square cut. Remove any burrs, loose fibers or wires.



Fittings – Inspect socket for damaged or missing threads. Do not use if conditions exist.



Inspect nipple for a through-hole, damaged or missing threads and improperly crimped nut (if applicable). Do not use if these conditions exist.

2

Assembly

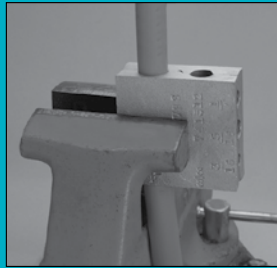

Using the Parker VBS or VBL vise block, place hose in proper hole of the vise block and then clamp in a bench vise. Ensure enough hose extends from the vise block to install socket.

Caution

Ensure hose is installed in correct size hole of vise block. Clamping hose in a smaller hole will crush hose.

3

Assembly

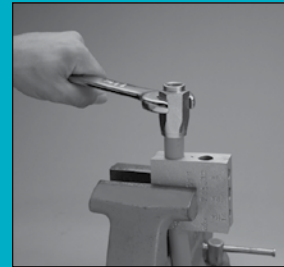

Using a wrench, screw socket onto hose counterclockwise until it bottoms. Ensure end of hose is against inside shoulder. Back off socket 1/4 turn clockwise.

Socket should be firm when tightened but not difficult to turn. If socket is difficult to install, apply lubricant that is compatible with the hose material.

Note

Do not use a lubricant with MS series.

Hose Assembly & Crimping

Field Attachable (cont.)

Series 51, BU & MS (Do not use these fittings on oxygen service lines)

4

Assembly

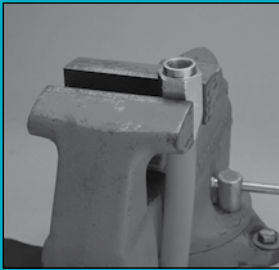

Place hex portion of socket into vise and tighten vise. Ensure socket extends past vise jaws enough to allow for installation of nipple.

Caution

When tightening socket in vise, do not over tighten vise jaws. Over tightening vise jaws will distort internal threads of socket and hamper installation of nipple.

5

Assembly

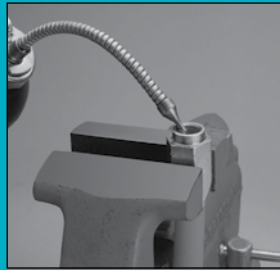

Using an SAE 20 weight lubricating oil, generously lubricate nipple and socket, threads and hose I.D.

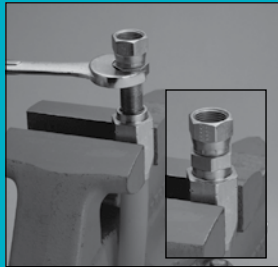

Using a wrench on the nipple hex, screw nipple into socket clockwise until nipple bottoms against socket shoulder.

Caution

Nipple should be firm when tightened but not difficult to turn. If nipple is difficult to install, check hose for proper lubrication. Re-apply lubricating oil as necessary. Installation of nipple without proper lubrication will damage core tube.

6

Inspection



Measure and verify hose assembly length.

For detailed ordering information, please consult price list or contact Parflex® Division.

Parker Hannifin Corporation | Parflex® Division | Ravenna, Ohio | parker.com/pfd

www.comoso.com



G-27

A Hose

B Tubing

C Coiled Air Hose & Fittings

D Transportation

E Fittings

F Tooling, Equipment & Accessories

G General Technical

Hose Assembly & Crimping

PTFE Permanent Crimp

Series 91, 91N & 93N

CAUTION: There are several different sections for Hose Assembly and Crimping. Be sure you are in the section that corresponds to the fitting series you are using. See **Table of Contents** for listing.

1

Cut

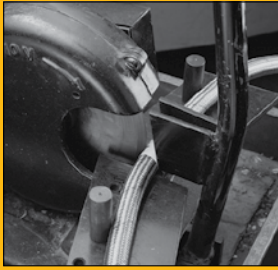

Using a power hose cutoff saw, cut hose squarely.

Note

PTFE Hose should be taped prior to cutting. Hose should be cut at center point of taped section.

2

Inspection

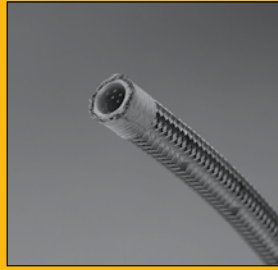

Hose – Visually inspect both ends of hose for square cut. Remove any burrs, loose fibers or wires.



Fittings – Verify fitting series corresponds to the selected hose. Visually inspect fitting(s) for a through-hole, threads and damage.

3

Assembly Prep

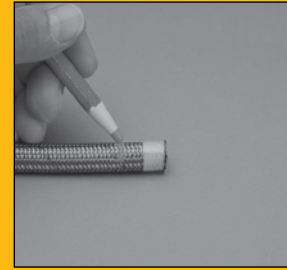

Insertion Depth – Mark hose end with proper insertion depth line. See Hose Fitting Insertion Values, pg. G-43 for insertion depths of fitting series that do not incorporate an insertion depth. For jacketed PTFE hoses, use a sharp knife and light pressure to cut back the cover at least the length of the insertion depth of the fitting.

Warning

Do not use lubricating oil when installing fittings on hose used in oxygen service. When installing fittings on hose used in oxygen service, lubricate with a non-oil based soap solution. Failure to do so may result in an explosion and personal injury when hose is used.



Assemble hose – Push fitting onto hose slightly and then remove tape. Continue pushing fitting onto hose until fitting reaches depth insertion mark.

Hose Assembly & Crimping

PTFE Permanent Crimp (cont.)

Series 91, 91N & 93N

4

Die Selection

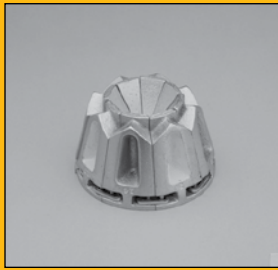

Select proper Parkrimp die set. (Reference Crimp Die Selection Charts - pg. G-13 or Crimpsource online at www.parker.com/crimpsource)

5

Lubricate Bowl



Using a premium, quality, lithium-base grease, apply a thin layer of grease on bowl of crimper base plate.

6

Die & Spacer Ring



Crimp Die – Place die set into bowl.



Die Ring – Place applicable die ring on top of die. Position ring so it is centered on die.

(Parflex hoses utilize silver die ring with the exception of HTB hose. Reference Crimp Die Selection Charts - pg. G-13 or Crimpsource online at www.parker.com/crimpsource)

7

Crimp



Assemble hose – Insert hose and fitting from bottom of crimper and up through die set. Position fitting so bottom of fitting skirt rests on die step (PARKALIGN® feature).

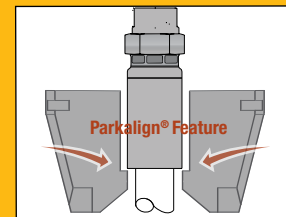

While holding hose and fitting in position on die step, crimp fitting onto hose until die ring contacts base plate.

Warning

Keep fingers and hands away from die-pusher area. Failure to do so may result in personal injury.

Note

Pump on crimper must not exceed the rated pressure of the crimper being used. Parker Hannifin will not accept responsibility for the operation of or provide warranty coverage for a crimper that is operated by a power unit other than equipment supplied by Parker Hannifin for the express purpose of operating the crimper.

For detailed ordering information, please consult price list or contact Parflex® Division.

Parker Hannifin Corporation | Parflex® Division | Ravenna, Ohio | parker.com/pfd

www.comoso.com



G-29

A Hose

B Tubing

C Coiled Air Hose & Fittings

D Transportation

E Fittings

F Tooling, Equipment & Accessories

G General Technical

Hose Assembly & Crimping

PTFE Permanent Crimp (cont.)

Series 91, 91N & 93N

8

Measure & Inspect



Measure and verify hose assembly length.

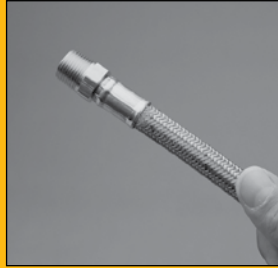

Inspect insertion depth mark at fitting ends. Insertion mark must be visible but not exceed 1/8" from end of crimped fitting shell.

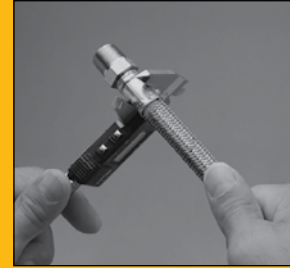

Measure crimp diameter of each fitting at top, middle and bottom of shell. Take measurements at a minimum of three places around shell circumference. Verify crimp diameter is within tolerances.

(Reference Crimp Die Selection Charts - pg. G-13 or Crimp-source online at www.parker.com/crimpsource)

Hose Assembly & Crimping

PTFE Crimp

Series PAGE Fittings

CAUTION: There are several different sections for Hose Assembly and Crimping. Be sure you are in the section that corresponds to the fitting series you are using. See Table of Contents for listing.

1

Inspection/Marking

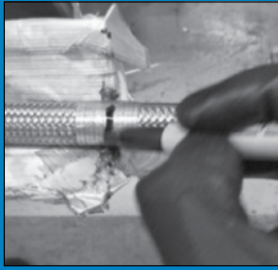

Obtain correct hose, fittings and collars per customer order. Inspect to make certain no defects are present on fittings, collars or hose.

Using 1" wide filament tape, apply 1 to 1½ wraps of tape tightly around hose at location to be cut. Mark tape in the middle where cut will be made. Tape will be left on during crimping so only ½" width of tape should remain.

Fittings – Inspect each component for possible damage. In addition, inspect socket and nipple for a through-hole and threads.

2

Cutting

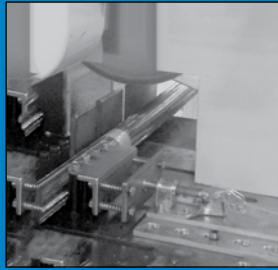

Using a rotary power cutting saw with a smooth toothless blade, cut hose squarely to proper length. Fitting length being used in the assembly shall be taken into account when calculating hose length.



Blow ends of hose off / out to remove any debris left from cutting operation. Cut off wires or fabric extending past the end of hose.

3

Assembly

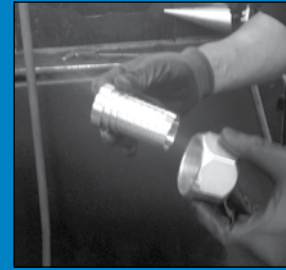

PAGE series fittings are not one piece but two pieces (insert + collar) and must be properly installed to assure leak free long life assemblies.

A
Hose

B
Tubing

C
Coiled Air Hose
& Fittings

D
Transportation

E
Fittings

F
Tooling, Equipment
& Accessories

G
General Technical

For detailed ordering information, please consult price list or contact Parflex® Division.

Parker Hannifin Corporation | Parflex® Division | Ravenna, Ohio | parker.com/pfd

www.comoso.com



G-31

Hose Assembly & Crimping

PTFE Crimp (cont.)

Series PAGE Fittings

4

Assembly

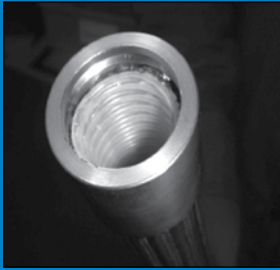

a. Orient and place collar on hose end fully.

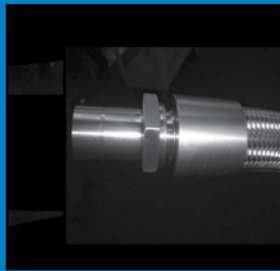

b. Using a taper punch, push punch into tube to enlarge bore of hose so insert just slides into hose.

c. Push insert into hose until lock groove of insert is just at end of collar.

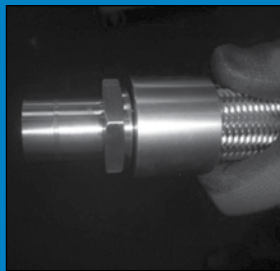

d. Pull collar out towards end of insert until at correct crimp position on insert of collar.

5

Assembly

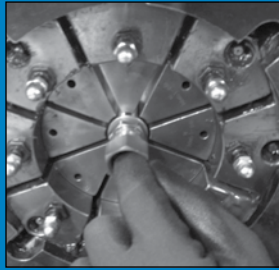

Crimp assembly only in Parker Approved adjustable crimper. Select correct die and crimp spec from Parker Crimp Source.

www.parker.com/crimpsource

a. Place assembly into crimp dies so full collar length crimp is obtained.

b. Check crimp dimensions in four places around the middle of the crimp circumference. Verify the average of those readings is within crimp specification tolerances. Adjust crimper up or down if needed to obtain proper dimension.

c. Crimp opposite end following the same procedures.

6

Inspect

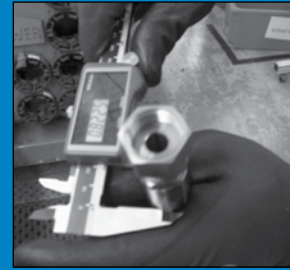

Inspect assembly, noting the length.

a. Test to correct test pressures to assure no leaks are observed using hydrostatic pressure unit (recommended). Air or nitrogen under water can be used with caution utilizing the proper pressure and procedures for that equipment.

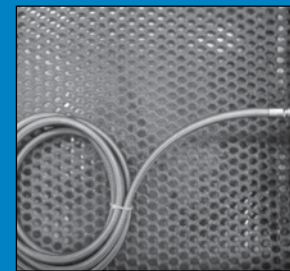

Blow out all water from the assembly and recheck length.

**Note any movement of length and make compensations as needed on next assembly.

Package assembly appropriately for customer requirements.

Hose Assembly & Crimping

PTFE Field Attachable
Series 90

CAUTION: There are several different sections for Hose Assembly and Crimping. Be sure you are in the section that corresponds to the fitting series you are using. See Table of Contents for listing.

1

Inspection



Hose – Visually inspect both ends of hose for square cut. Remove any burrs, loose fibers or wires.



Fittings – Inspect each component for possible damage. In addition, inspect socket and nipple for a through-hole and threads.

2

Assembly



Slide two sockets over end of hose with bottom of sockets back to back. Position sockets at each end of hose.

Note

When installing sockets on hose, check hose ends to determine if wire braid “necks down” (bends inward). If one end “necks down” use this end to slide sockets onto hose.

3

Assembly

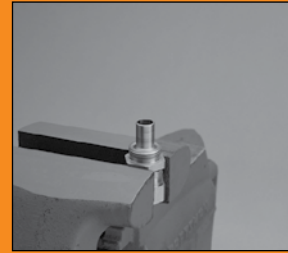

Mount nipple hex in vise. Ensure nipple end extends beyond vise jaws sufficiently to allow installation of hose.



Push hose bore onto nipple to size tube and to aid in separating braid before assembling ferrule onto hose.

Once completed, remove hose from nipple.

A
Hose

B
Tubing

C
Coiled Air Hose
& Fittings

D
Transportation

E
Fittings

F
Tooling, Equipment
& Accessories

G
General Technical

For detailed ordering information, please consult price list or contact Parflex® Division.

Parker Hannifin Corporation | Parflex® Division | Ravenna, Ohio | parker.com/pfd

www.comoso.com



G-33

Hose Assembly & Crimping

PTFE Field Attachable (cont.)

Series 90

4

Assembly



By hand, push sleeve over end of PTFE core tube and under wire braid.



To complete positioning of sleeve, push hose end with sleeve against a solid flat surface.

5

Assembly



Verify tube butts against inside shoulder of ferrule.

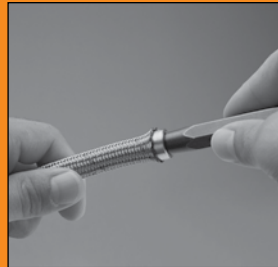

Using a tapered punch, push punch into end of sleeve and tube to set sleeve bars into tube.

6

Assembly



Using SAE 20 weight oil, lubricate nipple and socket threads. For stainless steel fittings use Parker ThreadMate™ or a molybdenum type lubricant.

Warning

Do not use lubricating oil when installing fittings on hose used in oxygen service. When installing fittings on hose used in oxygen service lubricate with a non-oil based soap solution. Failure to do so may result in an explosion and personal injury when hose is used.



Assemble hose – Using a twisting motion, push hose over nipple until hose is seated against nipple chamfer.

Hose Assembly & Crimping

PTFE Field Attachable (cont.)

Series 90

7

Assembly



Push socket forward and hand-start threading of socket to nipple.

Caution

When tightening socket in vise, do not over tighten vise jaws. Over tightening vise jaws will distort internal threads of socket.



Remove assembly from vise and reposition with socket in vise jaws. Ensure socket extends beyond vise jaws far enough to allow nipple to be completely tightened.

8

Assembly



Wrench tighten nipple hex until clearance between hex and socket hex is 1/32" or less.



Tighten further to align corners of nipple and socket hexes if necessary.

9

Measure & Inspect

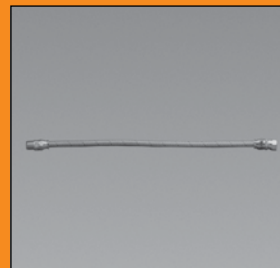

Measure and verify hose assembly length.

For detailed ordering information, please consult price list or contact Parflex® Division.

Parker Hannifin Corporation | Parflex® Division | Ravenna, Ohio | parker.com/pfd

www.comoso.com



G-35

A Hose

B Tubing

C Coiled Air Hose & Fittings

D Transportation

E Fittings

F Tooling, Equipment & Accessories

G General Technical

SQ-Swage Instructions

Sewer Hose

CAUTION: There are several different sections for Hose Assembly and Crimping. Be sure you are in the section that corresponds to the fitting series you are using. See **Table of Contents** for listing.

1

Inspection

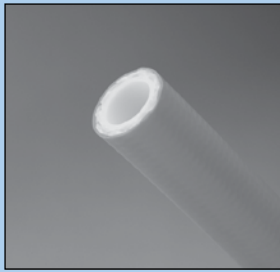

Hose – Visually inspect both ends of hose for square cut. Remove any burrs, loose fibers or wires.



Fittings – Visually inspect fitting for properly crimped shells, internal barbs, a through-hole and damage.

2

Assembly

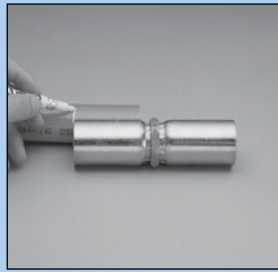

Insertion Depth – Mark hose end with proper insertion depth line.



Lubricate – Using an SAE 20 weight oil, lightly lubricate inside of both hose ends.

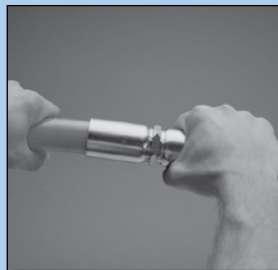

Assemble hose – Push each hose end into fitting to the depth insertion mark.

3

Assembly

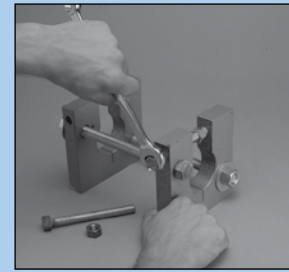

Remove both die securing bolts and nuts.

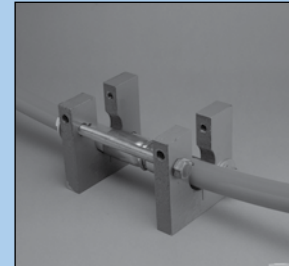

Place hose and fitting assembly into position on swager.

SQ-Swage Instructions (cont.)

4

Assembly

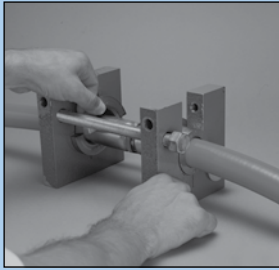

Insert both die halves around hose in each end of swager.

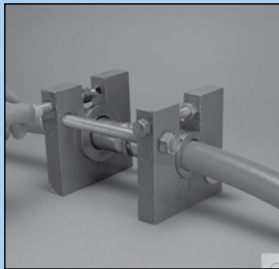

Install both die securing bolts with nuts positioned in opening of swager plates. Tighten die securing bolts 1/4 turn past finger tight.

Caution

When swaging stainless steel fittings, lubricate through-hole of dies with ThreadMate™. Failure to do so may result in damage to fittings.

5

Assembly

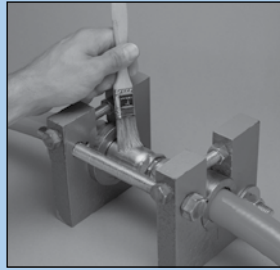

Lubricate – Using an SAE 20 weight oil, lightly lubricate inside of both hose ends.

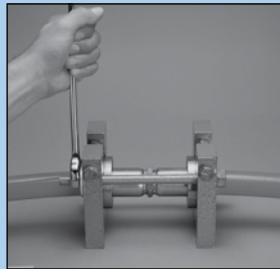

Assemble hose – Align swager plates in parallel and tighten nuts on swaging bolts uniformly until dies touch.

Caution

Ensure swager plates remain in parallel when tightening swager bolts. Failure to do so will result in an improperly swaged fitting.

6

Assembly

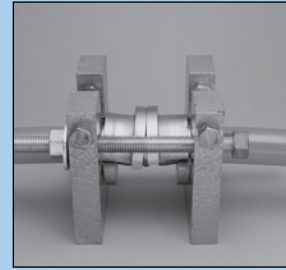

Loosen swaging bolts to release pressure on dies.

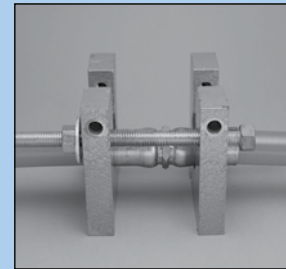

Remove die securing bolts and nuts. Then remove dies.

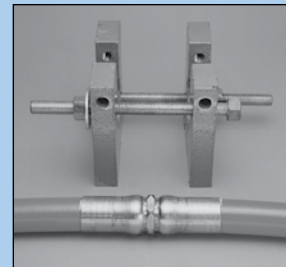

Assemble hose – Remove completed hose assembly.

A Hose

B Tubing

C Coiled Air Hose & Fittings

D Transportation

E Fittings

F Tooling, Equipment & Accessories

G General Technical

For detailed ordering information, please consult price list or contact Parflex® Division.

Parker Hannifin Corporation | Parflex® Division | Ravenna, Ohio | parker.com/pfd

www.comoso.com



G-37

SQ-Swage Instructions (cont.)

7

Measure & Inspect

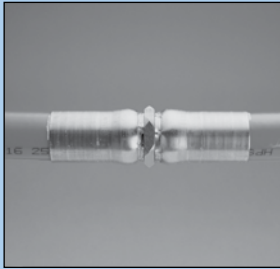

Measure and verify hose assembly length.

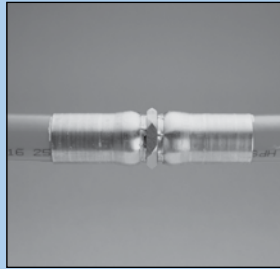

Inspect insertion depth mark at fitting ends. Insertion mark must be visible but not exceed 1/8" from end of crimped fitting shell.

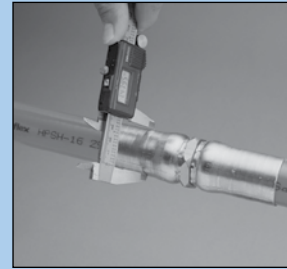

Measure swage diameter of each fitting at top, middle and bottom of shell. Take measurements at a minimum of three places around shell circumference. Verify swage diameter is within tolerances.

(Reference Swage Specification & Tool Selection Chart on pg. G-42 for proper swage diameters.)

Twin/Multi-Line Separation

Factory-built assemblies are available using twin/multi-line hoses. When field-built assemblies are preferred, the following steps must be taken.

1

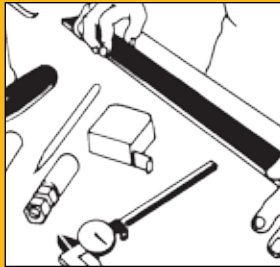

Set-Up – Position twinned or multi-line hose assembly so that it lies flat on work surface without tendency to twist or turn.

2

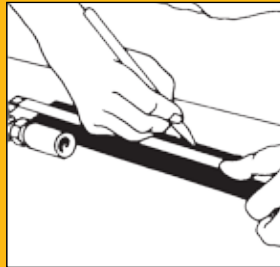

Measure hose to length – Measure and mark the length that the hoses are to be separated (commonly referred to as Split-back Length).

3

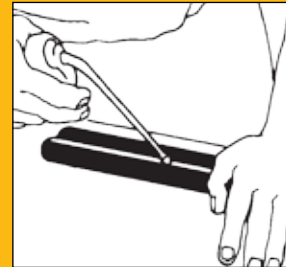

Lubricate – Lightly lubricate the web area between the hoses. Distribute the lubricant uniformly along the web of the assembly to be separated. Any lightweight oil will suffice (SAE 10 or 20). The function of the oil is to reduce the friction of the knife blade so that it naturally seeks the center of the valley formed by the hoses. This eliminates the need for the operator to steer the knife.

For detailed ordering information, please consult price list or contact Parflex® Division.

Parker Hannifin Corporation | Parflex® Division | Ravenna, Ohio | parker.com/pfd

www.comoso.com



G-39

Twin/Multi-Line Separation (cont.)

4

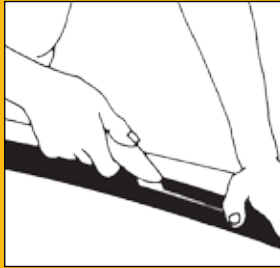

Cut Hose to Length – Press the multi-line hose assembly firmly and flat against the work surface with your free hand so that it does not move. Using a sharp utility knife, carefully draw the knife toward you with constant light to moderate pressure, and a smooth stroke. Multiple strokes will be necessary to separate the hoses.

Note

It is important that the knife blade be perpendicular to the hose during this procedure so that the blade cuts only the center line of the web. Extreme care must be taken to avoid cutting through the cover of the hoses and thereby exposing the hose reinforcement. If this occurs, the hose assembly must be discarded (See Figure 1). If the separation length is greater than that which can be accomplished with one continuous, smooth stroke, then the procedure should be repeated over shorter distances always cutting toward the free end of the hoses.

5

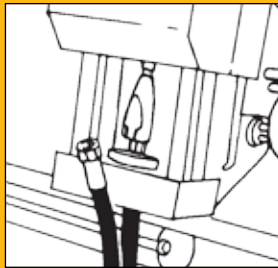

Measure Separation – It is suggested that the separation length be sufficiently long so that the swaging or crimping operation can be accomplished without risk of kinking the hoses or tearing the web which could result in exposure of the hose reinforcement (See Figure 2).

6



Apply Tape – At the option of the assembler, as dictated by the installation, a nylon lashing strap or tape may be applied at the termination of the separated length to provide protection against tearing of the web or hose covers.

INCORRECT HANDLING

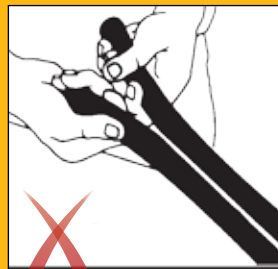

Figure 1 – Extreme care must be taken to avoid cutting through the cover of the hoses and thereby exposing the hose reinforcement. If this occurs, the hose assembly must be discarded.

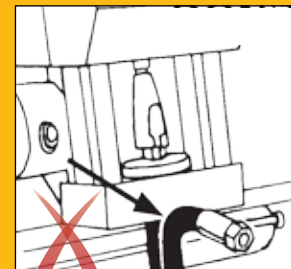

Figure 2 – The separation length must allow for the swaging or crimping operation without damaging the hose.

Ferrul-Fix Installation Instructions

Fast, on-the-job repair for ruptured bent tube hose assemblies and power steering lines.

The life of the combination tube-hose assembly is often limited to the service life of the hose alone. A replacement assembly may not be available, since equipment dealers are unable to stock all of the many odd tube configurations.

Parker Ferrul-Fix hose end fitting now makes it possible to salvage the bent tube section of the original assembly for replacement. Most importantly, it gets you back into operation FAST!

Features

- Gets you back in operation fast - No costly delays while replacement assemblies are rushed from the factory.
- Lets you reuse expensive bent tube ends - You can replace the hose at a fraction of the cost of complete assembly.
- Eliminates need for emergency brazing or welding in the field - Ferrul-Fix can be assembled without special tools or equipment.
- 3-Piece Design - Body, nut, ferrule. Wedging action of ferrule, when drawn down by nut, forms seal between body and ferrule, while cutting edge of ferrule bites into tube wall forming another positive seal.
- Visible Bite - Extent of bite at cutting edge of ferrule is completely visible when fitting is disassembled, an important safety feature. Self-centering action assures an even bite around circumference of tube.
- Parkerized Finish - Ferrul-Fix fittings have the Parkerized black finish, providing built-in torque in make-up.

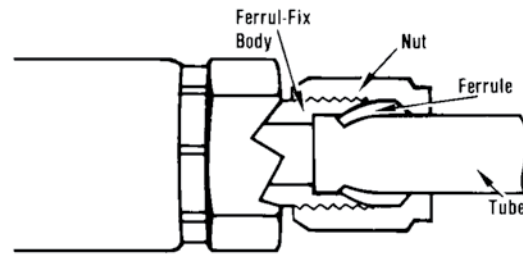

Assembly

1. **Cut** the formed tube off squarely next to the permanent hose fitting. Lightly **deburr** the end of the tube internally and externally.
2. **Disassemble** the Ferrul-Fix fitting, and **lubricate** threads and both ends of the ferrule with Parker Ferulube.
3. **Slide** nut and ferrule onto tubing with the long, straight end of the ferrule pointing toward the tube end.
4. **Insert** tube end into the Ferrul-Fix body until it bottoms against the shoulder. **Slide** ferrule inside body, and screw nut down finger tight.
5. **Wrench** nut down 1-3/4 turns to preset the ferrule.
6. **Disconnect** nut and **inspect** lead edge of ferrule to make certain that the biting edge has turned up a shoulder to a height of at least 50% of the ferrule and completely around the tube.
7. **Assemble** Ferrul-Fix fitting to hose. **Refer** to assembly instructions listed in appropriate fittings section. Do not assemble to hose before steps 1-6.
8. **Reassemble** tubing into Ferrul-Fix end and **turn** nut down easily until a sudden increase in force is evident. **Turn** bent tube to proper position if required. Using two wrenches, one on the fitting nipple hex and the other on the nut, **tighten** nut an additional 1/6 turn (one wrench flat).

Ferrule-Fix is Manufactured by the Tube Fittings Division. Refer to Catalog 4300 for Ferulok® instructions.

For detailed ordering information, please consult price list or contact Parflex® Division.

Parker Hannifin Corporation | Parflex® Division | Ravenna, Ohio | parker.com/pfd

www.comoso.com



G-41

A
Hose

B
Tubing

C
Coiled Air Hose
& Fittings

D
Transportation

E
Fittings

F
Tooling, Equipment
& Accessories

G
General Technical

Die Selection & Swage Specification Chart

Sewer Hose

SWAGE DATA FOR SEWER CLEANING HOSE (SQ-101-SW SWAGE MACHINE ONLY)								
Hose Type	Hose I.D.	Male Pipe			Mender/Splicer		Swage O.D. +/-0.015	Swage Length
		Fitting P/N	Die P/N	Pusher P/N	Fitting P/N	Die P/N		
	inch						inch	inch

S612	3/4	101SQ-12-12	SQ-101-12S6/S9	SQ-101-12P	1HUSQ-12-12	SQ-101-12S6/S9	1.172	1.109
S616	1	101SQ-16-16	SQ-101-16S6	SQ-101-16P	1HUSQ-16-16	SQ-101-16S6	1.445	1.156

S912	3/4	101SQ-12-12	SQ-101-12S6/S9	SQ-101-12P	1HUSQ-12-12	SQ-101-12S6/S9	1.172	1.109
S916	1	101SQ-16-16	SQ-101-16S9	SQ-101-16P	1HUSQ-16-16	SQ-101-16S9	1.488	1.156

Comments:

1. Two dies required when swaging a mender/splicer fitting. A pusher is not required when swaging a mender/splicer fitting.
2. One die and one pusher required when swaging a male pipe fitting.
3. End fittings cannot be swaged on S4 series hose. Only mender/splicers can be swaged.
4. End fittings cannot be swaged on S5 series hose. Only mender/splicers can be swaged.
5. Fittings cannot be swaged on SLH series hose.

The information covered in the Swage Specification & Tool Selection Chart pertains to steel, stainless and brass hose fittings. Swage diameter roundness shall not vary by more than .010". Swage diameters are measured in the center to the crimp area. Parflex Division reserves the right to alter swage specifications.



For detailed ordering information, please consult price list or contact Parflex® Division.

Hose Fitting Insertion Values

Inch

Hose Dash Size	51	54	56	55/57/58	58H	91N	92	93N	BU	CY	LV/LH	MS Reusable	MS Permanent
-2				5/8					1/2	1/2			
-3	13/16	5/8	5/8	29/32		7/16	9/16		13/16	13/16	13/16		
-4	15/16	3/4	15/16	1-3/16		1/2							
-5	15/16	7/8	1	1-3/16		9/16						11/16	11/16
-6	1-5/16	15/16	1	1-5/16		5/8		7/16				15/16	3/4
-8	1-19/32	15/16	1-1/8	1-9/16		11/16		7/16			2-1/8		
-10			1-1/4	1-11/16		11/16		3/4			2-1/4		
-12	1-13/16		1-3/8	1-23/32	2-3/16	3/4		7/8			2-3/8		
-16	1-9/16		1-7/8	2-9/32	2-15/16	15/16		15/16			2-13/16		
-20						1		1					
-24								1-1/8					
-32								1-3/8					

Metric (mm)

Hose Dash Size	51	54	56	55/57/58	58H	91N	92	93N	BU	CY	LV/LH	MS Reusable	MS Permanent
-2				16					13	13			
-3	21	16	16	23		11	14		21	21	21		
-4	24	19	24	30		13							
-5	24	22	25	30		14						17	17
-6	33	24	25	33		16		11				24	19
-8	40	24	28	40		17		11			54		
-10			32	43		17		19			57		
-12	46		35	44	56	19		22			60		
-16	40		48	58	75	24		24			71		
-20						25		25					
-24								29					
-32								35					

For detailed ordering information, please consult price list or contact Parflex® Division.

Parker Hannifin Corporation | Parflex® Division | Ravenna, Ohio | parker.com/pfd

www.comoso.com



G-43

A Hose

B Tubing

C Coiled Air Hose & Fittings

D Transportation



E Fittings







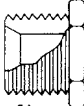
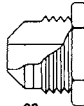
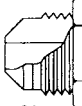

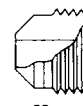
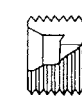
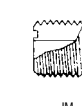
F Tooling, Equipment & Accessories

G General Technical

Hose Fitting Thread Guide

There are more than one hundred types of threads for fittings. Below are some of the most common thread styles offered by Parflex. The end code in a fitting part number is located directly after the first digit. ie. 10355-8-8

End Code								
Dash Size	NPTF Pipe Thread Size	SAE (JIC) 37° Flare Thread Size	SAE 45° Flare Thread Size	"O" Ring Style Straight Thread Size	SAE Inverted Flare Thread Size	PTT 30° Flare Thread Size	SAE Flareless Thread Size	Seal-Lok™ Thread
2	1/8 - 27	5/16 - 24	5/16 - 24	5/16 - 24	-	-	5/16 - 24	-
3	-	3/8 - 24	3/8 - 24	3/8 - 24	3/8 - 24	-	3/8 - 24	-
4	1/4 - 18	7/16 - 20	7/16 - 20	7/16 - 20	7/16 - 18	-	7/16 - 20	9/16 - 18
5	-	1/2 - 20	1/2 - 20	1/2 - 20	1/2 - 20	-	1/2 - 20	-
6	3/8 - 18	9/16 - 18	5/8 - 18	9/16 - 18	5/8 - 18	-	9/16 - 18	11/16 - 16
8	1/2 - 14	3/4 - 16	3/4 - 16	3/4 - 16	3/4 - 18	-	3/4 - 16	13/16 - 16
10	-	7/8 - 14	7/8 - 14	7/8 - 14	7/8 - 18	-	7/8 - 14	1 - 14
12	3/4 - 14	1 1/16 - 12	1 1/16 - 14	1 1/16 - 12	1 1/16 - 16	-	1 1/16 - 12	1 3/16 - 12
14	-	1 3/16 - 12	-	1 3/16 - 12	-	-	1 3/16 - 12	-
16	1 - 11 1/2	1 5/16 - 12	-	1 5/16 - 12	-	1 5/16 - 14	1 5/16 - 12	1 7/16 - 12
20	1 1/4 - 11 1/2	1 5/8 - 12	-	1 5/8 - 12	-	1 5/8 - 14	1 5/8 - 12	-
24	1 1/2 - 11 1/2	1 7/8 - 12	-	1 7/8 - 12	-	1 7/8 - 14	1 7/8 - 12	-
32	2 - 11 1/2	2 1/2 - 12	-	2 1/2 - 12	-	2 1/2 - 12	2 1/2 - 12	-

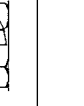
End Code									
Dash Size	Metric Swivel Female Thread Size	Metric Swivel Female Thread Size	Male Stud Thread Size	Male Stud Thread Size	Male BSPP Thread Size	BSP Swivel Female Thread Size	French Swivel Female Gas Series	French Swivel Female Metric Series	French Male Stud Gas Series
4	-	-	-	-	1/4"	1/4"	-	-	-
6	M12 x 1,5	-	M12 x 1,5	-	3/8"	3/8"	-	M12 x 1	-
8	M14 x 1,5	M16 x 1,5	M14 x 1,5	M16 x 1,5	1/2"	1/2"	-	M14 x 1,5	-
10	M16 x 1,5	M18 x 1,5	M16 x 1,5	M18 x 1,5	-	5/8"	-	M16 x 1,5	-
12	M18 x 1,5	M20 x 1,5	M18 x 1,5	M20 x 1,5	3/4"	3/4"	-	M18 x 1,5	-
-	-	-	-	-	-	-	M20 x 1,5	-	M20 x 1,5
14	-	M22 x 1,5	-	M22 x 1,5	-	-	-	M20 x 1,5	-
15	M22 x 1,5	-	M22 x 1,5	-	-	-	-	M22 x 1,5	-
16	-	M24 x 1,5	-	M24 x 1,5	1"	1"	-	M24 x 1,5	-
-	-	-	-	-	-	-	M24 x 1,5	-	M24 x 1,5
18	M26 x 1,5	-	M26 x 1,5	-	-	-	-	M27 x 1,5	-
20	-	M30 x 2	-	M30 x 2	-	-	-	M27 x 1,5	-
-	-	-	-	-	-	-	M30 x 1,5	-	M30 x 1,5
22	M30 x 2	-	M30 x 2	-	-	-	-	M30 x 1,5	-
25	-	M36 x 2	-	M36 x 2	-	-	-	M33 x 1,5	-
-	-	-	-	-	-	-	M36 x 1,5	-	M36 x 1,5
28	M36 x 2	-	M36 x 2	-	-	-	-	-	-
30	-	M42 x 2	-	M42 x 2	-	-	-	M39 x 1,5	-
33	-	-	-	-	-	-	M45 x 1,5	-	M45 x 1,5



Media to Fitting & Seal Compatibility

Media	Fitting Material			Seal Material			
	Brass	Steel	316 SS	BUNA-N	Ethylene Propylene	Fluorocarbon	Neoprene
Acetylene	NR	F	S	S	S	S	F
Air (oil free) @ 190° F	S	F	S	S	S	S	S
Air (oil free) @ 300° F	S	F	S	F	F	S	F
Air (oil free) @ 400° F	S	F	S	NR	NR	S	NR
Alcohol, Ethyl	S	NR	NR	NR	S	NR	S
Animal Oils (Lard Oil)	F	F	F	S	F	S	F
Aromatic Fuel - 50%	ID	ID	ID	F	NR	S	NR
Aromatic Solvents	ID	ID	F	F	ID	S	NR
Asphalt	NR	NR	S	F	NR	S	F
ASTM Oil #1	S	S	S	S	NR	S	S
ASTM Oil #2	S	S	S	S	NR	S	F
ASTM Oil #3	S	S	S	S	NR	S	NR
ASTM Oil #4	S	S	S	F	NR	S	NR
ATF Oil	S	S	S	S	NR	S	F
Automotive Brake Fluid	ID	ID	ID	NR	S	NR	F
Benzene	NR	F	NR	NR	NR	S	NR
Brine (Sodium Chloride)	NR	NR	S	S	S	S	S
Butane	NR	S	S	S	NR	S	S
Carbon Dioxide	S	F	S	S	S	S	S
Carbon Monoxide	S	S	S	S	S	S	F
Chlorine (Dry)	F	F	NR	NR	ID	F	F
Compressed Air	S	F	S	S	S	S	S
Crude Oil	NR	F	S	F	NR	S	NR
Cutting Oil	ID	S	S	S	NR	S	F
Diesel Fuel	S	S	S	S	NR	S	NR
Ethanol	S	NR	NR	NR	S	NR	S
Ethers	S	S	S	NR	F	F	NR
Freon 11	S	ID	ID	F	NR	F	NR
Freon 12	S	S	NR	F	NR	S	S
Freon 22	S	NR	S	NR	NR	NR	S
Fuel Oil	NR	S	S	S	NR	S	F
Gasoline	S	F	S	S	NR	S	NR
Gas, Liquid Propane (LPG)	S	S	S	S	NR	S	F
Gas, Natural	F	S	S	S	NR	S	S
Helium	S	S	S	S	S	S	S
Hydraulic Oil, Petroleum Base	S	S	S	S	NR	S	S
Hydraulic Oil, Water Base	ID	S	S	F	S	NR	F
Hydrogen Gas	S	S	S	S	S	S	S
Jet Fuel	S	S	S	S	NR	S	NR
Kerosene	S	S	S	S	NR	S	F
Lubricating Oil SAE 10, 20, 30, 40, 50	S	S	S	S	NR	S	F

For detailed ordering information, please consult price list or contact Parflex® Division.

Parker Hannifin Corporation | Parflex® Division | Ravenna, Ohio | parker.com/pfd

www.comoso.com



G-45

A
Hose

B
Tubing

C
Coiled Air Hose & Fittings

D
Transportation

E
Fittings

F
Tooling, Equipment & Accessories

G
General Technical

Media to Fitting & Seal Compatibility (cont.)

Media	Fitting Material			Seal Material			
	Brass	Steel	316 SS	BUNA-N	Ethylene Propylene	Fluorocarbon	Neoprene
Methanol	S	S	S	S	S	NR	S
MIL-F-8192 (JP-9)	S	S	S	NR	NR	S	NR
MIL-H-5606	S	S	S	S	NR	S	F
MIL-H-6083	S	S	S	S	NR	S	S
MIL-H-7083	S	S	S	S	S	F	F
MIL-H-8446 (MLO-8515)	F	S	S	F	NR	S	S
Mil-L-2104 & 2104B	S	S	S	S	NR	S	F
MIL-L-7808	NR	F	S	F	NR	S	NR
Mineral Oil	S	S	S	S	NR	S	F
Nitrogen	S	S	S	S	S	S	S
Petrolatum	S	S	S	S	NR	S	F
Petroleum Oil (<250° F)	S	S	S	S	NR	S	F
Propane	S	S	S	S	NR	S	F
R134A	S	S	S	NR	S	NR	NR
Sea Water	F	NR	S	S	S	S	F
Skydrol 500, Type 2	NR	S	S	NR	S	NR	NR
Skydrol 7000, Type 2	NR	S	S	NR	S	F	NR
Soap Solutions	NR	NR	S	S	S	S	F
Steam (<400° F)	F	S	S	NR	S	NR	NR
Stoddard Solvent	F	S	S	S	NR	S	F
Transmission Fluid (Type A)	S	S	S	S	NR	S	F
Trichloroethane	ID	F	S	NR	NR	S	NR
Water	S	F	S	S	S	F	F

Table U4 – Fluid Compatibility Chart

Codes:

S = Satisfactory

F = Fair

NR = Not recommended

ID = Insufficient data



For detailed ordering information, please consult price list or contact Parflex® Division.

Parker Hannifin Corporation | Parflex® Division | Ravenna, Ohio | parker.com/pfdwww.comoso.com

Metal Tube & Fitting Material Compatibility

As a general rule, tube and fitting materials should be the same. If different materials must be considered, the following chart can be used as a general guide. Since operating conditions differ with applications, this chart should be used only as a guide and not a firm recommendation. Before making a final

decision on material combination, it should be sufficiently tested under appropriate conditions to assure suitability for the intended application. For additional material combinations, contact the Tube Fittings Division.

Tube Material	Specification	Construction	Condition	Maximum Hardness	Temperature Range (7)	Application	Tube Material to Fitting & Material Compatibility												
							Seal-Lok™ ORFS (SAE J1453)			Triple-Lok® 37° Flare (SAE J514)				Ferulok® Flareless (SAE J514)			Intru-Lok® Flareless (ISO 8434-1)		
							S	SS	B	S	SS	B	M	S	SS	M	B	S	SS
Carbon Steel C-1010	SAE J524 (ASTM A179) (8)	Seamless	Fully Annealed	HRB 72	-65° to 500°F -55° to 260°C	High pressure hydraulics, air, & some specialty chemicals	E	NR	(6)	G	NR	(6)	NR	E	NR	NR	NR	NR	
	SAE J525 (ASTM A178) (8)	Welded & Drawn					E	NR	(6)	E	NR	(6)	NR	E	NR	NR	NR	NR	
	SAE J356	Welded & Flash Controlled					G	NR	(6)	NR	NR	(6)	NR	G	NR	NR	NR	NR	
Carbon Steel C-1021	SAE J2467	Welded & Flash Controlled	Fully Annealed	HRB 75	-65° to 500°F -55° to 260°C	High pressure hydraulics	E	NR	(6)	NR	NR	(6)	NR	E	NR	NR	NR	NR	
	SAE J2435	Welded & Drawn					E	NR	(6)	E	NR	(6)	NR	E	NR	NR	NR	NR	
Carbon Steel High Strength Low Alloy (HSLA)	SAE 2613	Welded & Flash Controlled	Sub-critically annealed	HRB 90	-65° to 500°F -55° to 260°C	High pressure hydraulics	E	NR	(6)	NR	NR	NR	NR	NR	NR	NR	NR	NR	
	SAE J2614	Welded & Drawn					E	NR	(6)	NR	NR	NR	NR	NR	NR	NR	NR	NR	
Alloy Steel 4130	ASTM A519	Seamless			-65° to 500°F -55° to 260°C	High pressure hydraulics	E	NR	NR	NR	NR	NR	NR	NR	NR	NR	NR	NR	
St 37.4 (Carbon Steel)	DIN 2391 Part 2 (Metric)	Seamless	Fully Annealed	HRB 72	-65° to 500°F -55° to 260°C	High pressure hydraulics, air, & some specialty chemicals	E	NR	NR	G	NR	NR	NR	NR	NR	NR	NR	E	
Stainless Steel 304 & 316	ASTM A213 ASTM A269	Seamless	Fully Annealed	HRB 90	-425° to 1200°F -255° to 650°C (3)	High pressure, high temp, or generally corrosive media (1)	(6)	E	(6)	(6)	G	(6)	NR	(6)	E	NR	NR	NR	
	ASTM A249 ASTM A269	Welded & Drawn					(6)	E	(6)	(6)	E	(6)	NR	(6)	E	NR	NR	NR	
1.4571 1.4541 Stainless Steel	DIN 17458 Tab 8 (Metric)	Seamless	Fully Annealed	HRB 90	-425° to 120°F -255° to 650°C (3)	High pressure, high temp, or generally corrosive media (1)	(6)	E	NR	(6)	G	NR	NR	NR	E	NR	NR	E	
Copper	SAE J528 (ASTM B-75) (8)	Seamless	Soft Annealed Temper 0	60 Max. Rockwell 15T	-325° to 400°F -200° to 205°C	Low pressure, low temp, water, oil & air	E	(6)	E	G	(6)	E	NR	G	(2)	NR	NR	E	E
Aluminum 6061	ASTM-B210	Seamless	T6 Temper	HRB 56	-325° to 400°F -200° to 205°C	Low pressure, low temp, water, oil, air & some specialty chemicals	NR	NR	NR	G	NR	NR	NR	E	(2)	NR	NR	(6)	NR
			O & T4 Temper	HRB 30			E	(5)	NR	NR	G	NR	NR	NR	E	(2)	NR	NR	(6)

(Cont.)

For detailed ordering information, please consult price list or contact Parflex® Division.

Parker Hannifin Corporation | Parflex® Division | Ravenna, Ohio | parker.com/pfd

www.comoso.com



G-47

A Hose

B Tubing

C Coiled Air Hose & Fittings

D Transportation

E Fittings

F Tooling, Equipment & Accessories

G General Technical

Metal Tube & Fitting Material Compatibility (cont.)

Tube Material	Specification	Construction	Condition	Maximum Hardness	Temperature Range (7)	Application	Tube Material to Fitting & Material Compatibility											
							Seal-Lok™ ORFS (SAE J1453)			Triple-Lok® 37° Flare (SAE J514)				Ferulok® Flareless (SAE J514)			Intru-Lok® Flareless	EO/EO-2 Flareless (ISO 8434-1)
							S	SS	B	S	SS	B	M	S	SS	M	B	S SS B, M
Monel 400	ASTM-B165	Seamless	Fully Annealed	HRB 70	-400° to 800°F -240° to 425°C	Sour gas, marine & gen chemical processing media	NR	(6)	NR	NR	(6)	NR	E	NR	(6)	E	NR	NR
Nylon		Extruded	Flexible & Semi-Rigid		-60° to 200°F -50° to 95°C	Lube lines, chemical process controls & air	NR	NR	NR	NR	NR	NR	NR	G (2)	G (2)	G (2)	E	G (2), (9)
Polyethylene	ASTM D-1248	Extruded	Instrument Grade		-80° to 150°F -60° to 65°C	Instrumentation lines	NR	NR	NR	NR	NR	NR	NR	G (2)	G (2)	G (2)	E	G (2), (9)
PVC		Extruded	Instrument & Laboratory Grade		0° to 140°F -20° to 60°C	General purpose laboratory use	NR	NR	NR	NR	NR	NR	NR	NR	NR	NR	G	NR
PTFE		Extruded & Sintered			-65° to 400°F -55° to 205°C	Very high temp, fuel, tube, chemical, pharma, food	NR	NR	NR	NR	NR	NR	NR	G (2)	G (2)	G (2)	G	G (2), (9)

Table U7 – Tube and Fitting Material Compatibility

Ratings Key:

NR = Not Recommended
F = Fair
G = Good
E = Excellent

Fittings Materials Code:

S = Steel
SS = Stainless Steel
B = Brass
M = Monel

Notes:

- For highly corrosive media or service environment, contact the Tube Fittings Division.
- Requires different assembly procedure. Contact the Tube Fittings Division.
- Low temperature limit for stainless steel Ferulok® fittings is -20°F (-30°C).
- For brazing only. Grade 4130 not recommended with Parflange process.
- For use with Parflange process only. Not recommended with brazing.
- Use depends on specific application. Contact the Tube Fittings Division.
- Applies to tube material.
- Comparable specifications to SAE.
- With metric version of tubing.
- Not tested with Parflange. Contact the Tube Fittings Division.



For detailed ordering information, please consult price list or contact Parflex® Division.

O-Ring Material Selection

Standard O-rings supplied with Parker tube fittings and adapters are 90 durometer hard nitrile (Buna-N) Parker compound #N0552. These O-rings are well suited for most industrial hydraulic and pneumatic systems. They have high extrusion resistance making them suitable for very high pressure static applications. Optional high temperature fluorocarbon, Parker compound #V0894, is also available for higher temperature specifications.

O-rings for other than normal hydraulic media or higher temperature applications can be selected from the following chart. The chart should be used only as a general guide. Before making final selection for a given application, it is recommended that appropriate tests be conducted to assure compatibility with the fluid, temperature, pressure and other environmental conditions.

For fluids not shown in the chart, please contact the Tube Fittings Division.

Polymer	Abbreviated Name	Parker Compound No.	Color	SAE J515 Type	Hardness Shore "A" ⁷	Temperature Range	Recommended For	Not Recommended For
Nitrile-Butadiene	NBR	N0552	● B	CH ²	90 ⁶	-30° to 250°F	Petroleum base oils and fluids, mineral oils, ethylene glycol base fluids, silicone and di-ester base lubricants, air, water under 150°F, and natural gas. Hydrogen fuel cells. Meets FDA requirements for food products. CNG Applications.	Phosphate ester base hydraulic fluids, automotive brake fluids, strong acids, ozone, freons, ketones, halogenated hydrocarbons, and methanol.
		N0674		-	70	-30° to 250°F		
		N0103		-	70	-65° to 225°F		
Nitrile-Butadiene (Low compression set – N1059)		N1059		CH ²	90	-30° to 275°F		
Nitrile-Butadiene		N0507		-	90	-65° to 180°F		
		N0304		-	75	-65° to 225°F		
		N0508		-	75	-35° to 250°F		
		N0756		-	75 ⁶	-65° to 275°F		
Ethylene-Propylene		EPDM		E0540	● B	CA ³		
	E0893		● P ¹	CA ³	80			
	E0962		● B	-	90			
Neoprene	CR	C0873	● B	-	70	-45° to 250° F	Refrigerants (freons, ammonia), high aniline point petroleum oils, mild acids and silicate ester lubricants.	Phosphate ester fluids and ketones.
		C0944	● R ¹	-	70			
Fluorocarbon	FKM ⁵ or FPM	V0747	● B	-	75	-15° to 400° F	Petroleum base oils and fluids, some phosphate ester base fluids, silicone and silicate ester base lubricants, di-ester base lubricants, acids and halogenated hydrocarbons.	Ketones, skydrol fluids, amines (VDMH), anhydrous ammonia, low molecular weight esters and ethers, and hot hydrofluoric or chlorosulfonic acids.
		V0884	● BR ¹	-	75			
		V0894	● BR ¹	HK ⁴	90 ⁶			
Silicone	Si	S0604	● RU ¹	-	70	-65° to 450° F	Dry heat (air to 400°F) and high aniline point oils.	Most petroleum fluids, ketones, water and steam.

Table U-6 – O-Ring Selection

*Color Code: B – Black, P – Purple, R – Red, BR – Brown, RU – Rust

Notes:

- These Parker "Chromassure" color assurance O-rings are available from the Parker Hannifin O-Ring Division. They help eliminate assembly errors, reduce warranty costs and liability risks, and assure safety in aftermarket business.
- Formerly SAE Type I.
- Formerly SAE Type II.
- Formerly SAE Type III.
- "FKM" is the ASTM designation for fluorocarbon. Its ISO designation is "FPM".
- Standard compounds available from stock.
- Use 90 durometer hard O-rings for applications with 1500 psi or higher pressures.

For detailed ordering information, please consult price list or contact Parflex® Division.

Parker Hannifin Corporation | Parflex® Division | Ravenna, Ohio | parker.com/pfd

www.comoso.com



Materials to Parflex Part Number Guide

Ratings Code:

- G – Good to excellent. Little or no swelling, tensile or surface changes. Preferred choice.
- L – Marginal or conditional. Noticeable effects but not necessarily indicating lack of serviceability. Further testing suggested for specific application. Very long-term effects such as stiffening or potential for crazing should be evaluated.
- P – Poor or unsatisfactory. Not recommended without extensive and realistic testing.
- – Indicates that this was not tested.
- # – For fluoropolymer. Indicates good chemical resistance but potential for excessive permeation.

MATERIAL CODE FOR HOSE CORE TUBES	
H	Copolyester
N	Nylon
NC	Nylon Copolymer
O	Copolymer
PFX	Proprietary Elastomer
TFE/PFA	Fluoropolymer PTFE/PFA
U	Polyurethane
MATERIAL CODE FOR HOSE COVERS	
EPDM	Rubber
HF	Low Temperature Copolyester
PFX	Proprietary Elastomer
M	Silicone
U	Polyurethane
MATERIAL CODE FOR THERMOPLASTIC TUBING	
HDPE	High Density Polyethylene
N	Flexible Nylon
NR	Unplasticized Nylon (semi-rigid)
PE	Linear Low Density Polyethylene
PEFR	Flame Resistant Polyethylene
PP	Polypropylene
PV	Flexible Polyvinyl Chloride (PVC)
U	Polyurethane
MATERIAL CODE FOR FLUOROPOLYMER TUBING	
FEP	Fluorinated Ethylene Propylene
PFA	Perfluoroalkoxy
TFE	Polytetrafluoroethylene
PVDF	Polyvinylidene Fluoride

PARKER PRODUCT	
D6, D6R, H6, R6, HFS, HFS2, HFSR, M8, HTB, HJK, 560, 563, 590, 593, 510C, 518C, 515H, 53DM/538DM, 55LT, HLB, S5N, S6, S9, SLH	
510D, 518D, 520N, 526BA, 527BA, 528N, 540N, 548N, 56DH/568DH, 573X, 575X, 580N, H580N, 588N, 1035HT, 5CNG, MSH, PTH	
510, 510A	
540P	
1035A	
919/919B, 919J, 919U, 929/929B, 929BJ, 939/939B, 943B, 944B, 950B, 955B, S30/S30B, S40/S40B, STW/STWB, SCW/SCB, PCW/PCB, SBF/SBFW, SCW/SCBV, PCW/PCBV, SCWV-FS/SCBV-FS, PCWV-FS/PCBV-FS	
83FR, B9	
PARKER PRODUCT	
RCTW/RCTB (Contact Engineering for chemical resistance questions)	
55LT, 53DM/538DM	
510C, 518C	
SWPV, 919J, 929BJ	
All except 55LT, 53DM/538DM, 518C, 1035HT and PTFE hoses	
PARKER PRODUCT	
HDPE	
N	
NR	
E	
PEFR	
PP	
PV	
U, HU	
PARKER PRODUCT	
103, 203, HS1.3FEP, HS1.6FEP,	
104, 204	
TFL, TFS, TFT, TFH, 101, 201, TFB, HS2TFS, HS2TFT, HS2TFL, HS2TFI, HS4TFI	
110,111	

For detailed ordering information, please consult price list or contact Parflex® Division.

Parker Hannifin Corporation | Parflex® Division | Ravenna, Ohio | parker.com/pfd

www.comoso.com



G-51

A
Hose

B
Tubing

C
Coiled Air Hose
& Fittings

D
Transportation

E
Fittings

F
Tooling, Equipment
& Accessories

G
General Technical

Media to Hose Material Compatibility Guide

Media	H	N	U/HF UFR	PV	NC	O	PFX	HFR	FEP	PTFE/ PFA
Acetaldehyde	G	L	L	P	-	L	L	G	G	G
Acetic Acid Glacial	L	L	L	G	P	G	L	L	L	G
Acetone	L	G	P	P	G	P	P	L	G	G
Acetylene	2	2	2	2	2	2	2	2	2	2
Air (4)	G	G	G	G	G	G	G	G	G	G
Ammonium Chloride	G	P	G	G	P	G	G	G	L	G
Ammonium Hydroxide	L	G	P	L	-	G	P	L	G	G
Anhydrous Ammonia	P	P	P	P	P	P	P	P	8	8
Aniline	P	P	P	P	P	L	P	P	G	G
Animal Oils (6)	G	G	G	G	G	P	G	G	-	G
Aromatic Hydrocarbons	L	G	L	P	G	P	L	L	-	G
Asphalt	G	G	G	G	G	L	G	G	L	G
Baygon (Insecticide)	L	G	P	-	-	-	P	L	-	G
Beer	G	G	G	G	-	G	G	G	G	G
Benzene	L	G	L	P	L	P	L	L	G	G
Brake Fluid (DOT #3)	-	G	P	P	-	P	P	-	-	G
Butane (2) (4)	G	G	L	L	P	L	L	G	#	#
Butter (6)	G	G	G	G	-	G	G	G	-	G
Calcium Chloride	G	3	G	L	3	G	G	G	G	G
Carbon Dioxide (4)	G	G	G	G	G	G	G	G	#	#
Carbon Monoxide (4)	G	3	G	G	3	L	G	G	#	#
Carbon Tetrachloride	L	G	P	L	G	P	P	L	G	G
Castor Oil	G	L	L	G	L	P	L	G	-	G
Chlorinated Hydrocarbon Base Fluids	L	G	L	P	-	-	L	L	-	G
Chlorinated Petroleum Oil	G	G	L	-	L	-	L	G	-	-
Chlorinated Solvents	P	3	P	L	3	L	P	P	-	G
Chlorine, Gaseous, Dry	P	P	P	G	P	L	P	P	#	#
Chlordane (Insecticide)	L	G	P	-	-	-	P	L	-	-
Chloroform	P	P	P	P	P	P	P	P	G	G
Chromic Acid	P	3	P	G	P	3	P	P	L	G
Citric Acid Solutions	G	G	L	G	G	G	L	G	G	G
Crude Petroleum Oil	G	G	G	G	G	P	G	G	-	G
Cyclohexane (2)	G	G	G	-	-	P	G	G	G	G
Cygon (Insecticide)	L	G	P	-	-	-	P	L	-	-
Diazion (Insecticide)	L	-	P	L	-	-				
Diesel Fuel (2)	G	G	G	L	G	P	G	G	-	G
Diester Oils	L	G	P	P	-	P	P	L	-	G
Enamels	G	G	G	L	-	L	G	G	-	G
Ethanol (6)	G	G	L	L	L	G	L	G	-	G
Ethers	L	G	P	L	G	L	P	L	G	G
Ethylene Glycol	L	G	L	G	G	G	L	G	G	G
Ethylene Oxide	G	G	L	P	-	L	L	G	#	#
Fatty Acids	G	G	3	G	G	L	3	G	G	G
Formaldehyde	L	L	P	L	L	G	P	L	G	G
Formic Acid	P	P	P	G	P	G	P	P	G	G

(Cont.)



For detailed ordering information, please consult price list or contact Parflex® Division.

Media to Hose Material Compatibility Guide (cont.)

Media	H	N	U/HF UFR	PV	NC	O	PFX	HFR	FEP	TFE
Freon 12 (5)	P	G	L	G	G	L	L	P	#	#
Freon 22 (5)	P	G	L	G	G	L	L	P	#	#
Fruit Juices	G	G	G	G	-	G	G	G	-	G
Fuel Oil (2)	G	G	L	L	G	P	L	G	G	G
Gas (Oil) (2)	G	G	G	G	G	P	G	G	-	G
Gas (Natural) (4)	2	2	2	2	2	2	2	2	2	2
Gasoline (2)	G	G	3	P	G	P	3	G	G	G
Glue	3	3	3	3	3	3	3	3	3	3
Glycerin	G	G	L	G	G	G	L	G	G	G
Glycols (to 135°F)	L	G	L	G	G	-	L	G	G	G
Grease (Petroleum base)	G	G	G	G	G	L	G	G	-	G
Heptachlor (Insecticide)	L	G	P	L	-	P	P	L	-	G
Hexane (2)	G	G	G	L	G	P	G	G	G	G
Houghto Safe-600 Series (Hydraulic fluid)	G	G	L	G	G	G	L	G	-	G
Houghto Safe-1000 Series (Phosphate esters)	L	G	P	G	G	P	P	L	-	G
Hydraulic Fluid (Petroleum base)	G	G	G	G	G	L	G	G	L	G
Hydraulic Fluid (Phosphate ester base)	L	G	L	L	G	P	P	L	-	G
Hydraulic Fluid (Water glycol base)	G	G	G	L	G	-	G	G	-	G
Hydraulic Oil (Petroleum base)	G	G	G	G	G	L	G	G	L	G
Hydrochloric Acid	P	L	P	L	P	L	P	P	G	G
Hydrofluoric Acid	P	P	P	L	P	L	P	P	G	G
Hydrogen, Gaseous (2) (4) (5)	G	G	G	G	G	G	G	#	#	
Hydrolube (Hydraulic fluid/water glycol base)	G	G	L	G	G	G	L	G	-	G
IRUS 902 (Hydraulic fluid/water-oil emulsion)	G	G	G	G	G	L	G	G	-	G
Isocyanates (2)	L	L	L	P	-	L	L	L	-	G
IsoOctane (2)	G	G	G	L	G	L	L	G	G	G
Isopropyl Alcohol	G	G	L	L	G	G	L	G	G	G
Kerosene (2)	G	G	L	L	G	L	P	G	G	G
Ketones	L	G	P	P	G	G	P	L	G	G
Lacquer Solvents	L	G	P	P	3	L	P	L	L	G
Lactic Acid	P	G	P	G	G	G	P	P	G	G
Lime (Calcium oxide)	G	G	G	G	-	G	G	G	G	G
Lindol (Hydraulic fluid/phosphate esters)	L	G	P	-	-	-	P	L	-	G
Linseed Oil	G	G	G	L	G	L	G	G	G	G
LP - Gas	2	2	2	2	2	2	2	2	2	2
Lubricating Oils (Diester base)	L	G	P	-	G	-	P	L	-	G
Lubricating Oils (Petroleum base)	G	G	G	G	G	L	G	G	G	G
Malathion (Insecticide)	L	G	P	-	-	-	P	L	-	G
Magnesium Hydroxide	L	G	L	G	-	G	L	L	G	G
Magnesium Salts	-	G	G	G	-	G	G	-	-	G
Mercury	G	G	G	G	G	G	G	G	G	G
Meropa Oil (Sulphur base)	G	G	-	-	-	-	-	-	-	G
Methane	2	2	2	2	2	2	2	2	2	2
Methanol	G	G	P	P	G	L	P	G	-	G
Methoxychlor (Insecticide)	L	G	P	-	-	-	P	L	-	G

(Cont.)

For detailed ordering information, please consult price list or contact Parflex® Division.

Parker Hannifin Corporation | Parflex® Division | Ravenna, Ohio | parker.com/pfd

www.comoso.com



G-53

A Hose

B Tubing

C Coiled Air Hose & Fittings

D Transportation

E Fittings

F Tooling, Equipment & Accessories

G General Technical

Media to Hose Material Compatibility Guide (cont.)

Media	H	N	U/HF UFR	PV	NC	O	PFX	HFR	FEP	TFE
Methyl Alcohol (6)	G	G	P	P	G	L	P	G	G	G
Methylene Chloride	P	L	P	L	P	L	P	P	G	G
Methyl Ethyl Ketone (MEK)	L	G	P	P	G	G	P	L	G	G
Methyl Ethyl Ketone Peroxide (MEKP)	-	L	P	-	-	-	P	-	-	G
Methyl Isobutyl Ketone (MIBK)	L	G	P	P	G	L	P	L	G	G
Milk (6)	G	G	G	G	-	G	G	G	G	G
Mineral Oil	G	G	G	G	G	L	G	G	G	G
Mineral Spirits	P	-	L	P	-	-	L	P	-	G
Motor Oils	G	G	G	G	G	-	G	G	G	G
Naphtha	L	G	P	P	G	P	P	L	G	G
Natural Gas (4)	2	2	2	2	2	2	2	2	2	2
Nitric Acid	P	P	P	L	P	P	P	P	L	G
Nitrobenzene	P	G	P	P	G	P	P	P	G	G
Nitrogen, Gaseous (4) (5)	G	G	G	G	G	G	G	G	G	G
Nitrous Oxide	-	L	-	G	-	L	G	-	#	#
Oil (SAE)	G	G	G	G	G	L	G	G	-	G
Oil of Turpentine	G	G	P	G	G	P	P	G	-	G
Oleic Acid	G	G	G	L	G	L	G	G	G	G
OS 45 Type 3 Hydraulic Fluid (Silicate esters)	L	G	L	P	-	P	L	L	-	-
Oxygen, Gaseous (4) (5) (6)	G	G	G	G	G	G	G	G	G	G
Ozone	L	P	L	G	P	L	P	L	G	G
Paint Solvents (Oil base)	L	G	L	P	-	P	L	L	-	G
Paint (Oil Base) (7)	G	G	G	P	-	L	G	G	-	G
Pentane (2)	G	G	L	L	-	P	L	G	G	G
Perchloric Acid	P	P	P	L	P	P	P	P	L	G
Perchloroethylene	P	P	P	L	P	P	P	P	-	G
Petroleum Ether	-	2	2	P	2	P	2	-	2	2
Petroleum Oils	G	G	G	G	G	L	G	G	-	G
Phenols	P	P	P	L	P	P	P	P	-	G
Phosphate Esters (above 135°F)	P	G	P	P	-	P	P	L	-	G
Phosphate Esters (to 135°F)	G	G	P	P	G	P	P	G	-	G
Polyol Esters	L	G	P	P	-	-	P	L	-	G
Potassium Hydroxide, 50%	P	P	P	L	-	L	P	P	G	G
Propane (4) (5)	2	2	2	2	2	2	2	2	2	2
Propylene Glycol	-	-	G	G	-	G	-	-	G	G
Pydraul F-9, 150, 160 (to 135°F)	G	G	P	P	G	P	P	G	-	G
Pydraul 312C, 625 (to 135°F)	P	G	P	P	G	P	P	G	-	G
Quintolubric 822 Fluid	-	G	G	-	-	-	-	-	-	G
Salt Water	3	3	3	3	3	3	3	3	G	G
Sevin (Insecticides in water)	G	G	G	-	-	-	G	G	-	G
Silicone Greases	G	G	G	G	G	-	G	G	-	G
Silicone Oils	G	G	G	G	G	-	G	G	-	G
Skydrol 500 & 7000	L	G	P	P	G	P	P	L	G	G
Soap Solutions	G	G	G	G	G	G	G	G	G	G

(Cont.)



For detailed ordering information, please consult price list or contact Parflex® Division.

Media to Hose Material Compatibility Guide (cont.)

Media	H	N	U/HF UFR	PV	NC	O	PFX	HFR	FEP	TFE
Soda Water	G	G	G	G	G	3	G	G	-	G
Sodium Borate	G	G	G	G	G	G	G	G	G	G
Sodium Carbonate	3	3	3	3	3	3	3	3	3	3
Sodium Chloride Solutions	G	G	G	G	3	G	G	G	G	G
Sodium Hydroxide, 50%	L	P	P	L	P	L	P	L	G	G
Sodium Hypochlorite	L	P	P	L	-	3	P	L	G	G
Steam	P	P	P	P	P	P	P	P	G	G
Stoddard Solvent	P	G	P	L	G	P	P	P	G	G
Straight Synthetic Oils (Phosphate esters)	L	G	P	P	G	-	P	L	-	G
Sulfur	G	G	G	G	-	L	G	G	G	G
Sulfur Dioxide	P	L	L	L	-	P	L	P	G	G
Sulfur Hexafluoride Gas (4) (5)	G	G	G	G	-	G	G	G	-	G
Sulphuric Acid	P	P	P	3	P	P	P	P	-	G
Toluene	L	G	L	P	G	P	P	L	G	G
Toloul	L	G	L	P	G	P	P	L	-	G
Transmission Fluid	G	G	G	P	G	-	G	G	-	G
Trichloroethylene	P	L	P	L	G	P	P	P	G	G
Trisodium Phosphate Solutions	L	G	P	G	G	G	P	L	G	G
Turpentine	G	G	L	L	G	P	P	G	G	G
Ucon (Hydraulic fluid-water glycol base)	G	G	L	G	G	-	L	G	-	G
Varnish	G	G	G	P	G	G	G	G	-	G
Vinegar (6)	L	G	L	G	G	G	L	L	G	G
Water (to 135°F) (6)	G	G	G	G	G	G	L	G	G	G
Water (above 135°F) (6)	P	G	P	L	-	P	P	P	L	G
Water Glycols (to 135°F)	L	G	L	G	G	L	L	G	-	G
Water Glycols (above 135°F)	P	G	P	L	-	P	P	P	-	G
Water in oil Emulsions (to 135°F)	G	G	L	G	G	-	L	G	-	G
Water in oil Emulsions (above 135°F)	P	G	P	L	-	-	P	P	-	G
Whiskey, Wines (6)	G	G	L	G	G	G	G	G	G	G
Wood Oils	G	G	L	G	G	-	G	G	-	G
Xylene	L	G	P	P	G	P	P	L	G	G
Zinc Chloride	G	G	G	G	P	G	G	G	G	G

Notes:

- The Fluid Compatibility Guides are simplified rating tabulations based on immersion tests at 75°F. Higher temperatures tend to reduce ratings. Since final selection depends on pressure, fluid and ambient temperature and other factors not known to Parker Hannifin Co., no performance guarantee is expressed or implied. Ratings do not imply compliance with specialized codes such as FDA, NSF, AGA or UL and do not cover possible fluid discoloration, taste or odor effects. For conveying foodstuffs, use FDA sanctioned materials and for potable water, use NSF listed materials. For chemicals not listed, or for advice on particular applications, please consult Product Engineering, Parflex Div., Ravenna, Ohio.
- Hose applications for these fluids must take into account legal and insurance regulations. This does not imply AGA or UL compliance.
- Satisfactory at some concentrations and temperatures, unsatisfactory in others.

- For high pressure gases, the cover should be pinpricked and the pressure must not be released quickly. Chain or restrain the hose to prevent personal injury in the event of damage or failure.
- Chemical compatibility does not imply low permeation rates. Consult the Parker factory for a suggestion for your specific requirement.
- Does not imply NSF or FDA compliance.
- Chemical compatibility does not imply acceptability for use in airless paint spray applications. These applications require a special conductive hose.
- Fluoropolymers are chemically compatible with Anhydrous Ammonia. However, extreme caution must be used in dealing with Anhydrous Ammonia since it can cause severe injuries such as blindness and/or chemical burns.

For detailed ordering information, please consult price list or contact Parflex® Division.

Parker Hannifin Corporation | Parflex® Division | Ravenna, Ohio | parker.com/pfd

www.comoso.com



G-55

A Hose

B Tubing

C Coiled Air Hose & Fittings

D Transportation

E Fittings

F Tooling, Equipment & Accessories

G General Technical

Media to Plastic Tubing Material Compatibility Guide

Media	PE	HDPE	PP	N	NR	PV	U	PEFR	FEP	PFA	TFE
Acetone	P	L	G	G	G	P	P	L	G	G	G
Acetyl Bromide	L	L	L	P	P	P	-	-	-	-	-
Acetyl Chloride	L	L	L	P	P	P	-	-	G	G	G
Air	G	G	G	G	G	G	G	G	G	G	G
Alcohols	G	G	G	G	G	L	L	G	G	G	G
Aluminum Salts	G	G	G	G	G	G	G	G	-	-	-
Ammonia	G	G	G	G	G	G	G	L	-	-	-
Amyl Acetate	G	G	G	G	G	P	L	-	G	G	G
Aniline	L	G	L	P	P	P	P	-	G	G	G
Animal Oils (6)	P	L	L	G	G	G	G	-	-	-	G
Arsenic Salts	G	G	G	G	G	G	G	G	-	-	-
Aromatic Hydrocarbons	P	L	L	G	G	P	L	P	-	-	G
Barium Salts	G	G	G	G	G	G	G	G	-	-	-
Benzaldehyde	P	L	L	L	L	P	L	P	G	G	G
Benzene	P	L	L	G	G	P	L	P	G	G	G
Benzyl Alcohol	P	G	L	L	L	G	L	P	G	G	G
Bleaching Liquors	G	L	G	L	L	L	L	-	-	-	-
Boric Acid Solutions	G	G	G	G	G	G	G	G	G	G	G
Bromine	L	L	P	P	P	P	P	-	G	L	G
Butane (2)	L	G	G	G	G	L	P	-	#	#	#
Butanol	G	G	G	G	G	G	G	G	-	-	-
Butyl Acetate	G	G	L	G	G	P	L	G	G	G	G
Calcium Hypochlorite	L	L	P	P	L	L	P	L	G	G	G
Calcium Salts	G	G	G	G	G	G	G	G	-	-	-
Carbon Dioxide	G	G	G	G	G	G	G	G	#	#	#
Carbon Disulfide	L	L	L	L	L	P	L	-	#	#	#
Carbon Tetrachloride	P	P	L	L	L	L	P	P	G	G	G
Caustic Potash	G	G	G	G	G	L	G	-	G	G	G
Caustic Soda	G	G	G	G	G	L	G	-	G	L	G
Chloracetic Acid	L	G	L	L	L	P	P	-	G	L	G
Chlorine (Dry)	L	L	L	P	P	G	P	-	#	#	#
Chlorine (Wet)	L	L	L	P	P	G	L	-	G	G	G
Chlorobenzene	P	L	L	L	L	P	L	P	G	G	G
Chloroform	P	L	P	P	P	P	P	P	G	G	G
Chromic Acid	L	L	L	P	P	G	P	-	L	G	G
Copper Salts	G	G	G	G	G	G	G	G	-	-	-
Cresol	P	L	L	P	P	L	P	P	G	G	G
Cyclohexanone	L	L	L	L	L	P	P	-	G	G	G
Ethers	L	L	P	G	G	L	P	-	G	G	G
Ethyl Acetate	G	G	G	G	G	P	L	-	G	G	G
Ethyl Alcohol	G	G	G	L	L	L	G	G	-	-	-
Ethylamine	L	G	L	L	L	P	L	-	-	-	-
Ethyl Bromide	P	L	L	L	L	P	-	P	-	-	-
Ethyl Chloride	P	L	P	L	L	P	-	P	G	G	G
Fatty Acids	L	L	L	G	G	L	L	P	G	G	G

(Cont.)



For detailed ordering information, please consult price list or contact Parflex® Division.

Media to Plastic Tubing Material Compatibility Guide (cont.)

Media	PE	HDPE	PP	N	NR	PV	U	PEFR	FEP	PFA	TFE
Ferric Salts	G	G	G	G	G	G	G	-	-	-	-
Formaldehyde	G	G	G	L	L	L	P	-	G	G	G
Formic Acid	G	G	G	P	P	G	P	G	G	G	G
Freon	L	L	L	G	G	P	L	-	#	#	#
Gasoline (2)	P	G	L	G	G	P	L	P	G	G	G
Glucose	G	G	G	G	G	G	G	G	G	G	G
Glycerin	G	G	G	G	G	G	L	G	G	G	G
Hydriodic Acid	L	G	G	P	P	G	-	-	-	-	-
Hydrochloric Acid. (Conc.)	L	G	G	L	L	L	P	-	G	L	G
Hydrochloric Acid. (Med. Conc.)	L	G	G	L	L	L	P	-	G	L	G
Hydrofluoric Acid	L	L	G	P	P	L	P	-	G	-	G
Hydrogen Peroxide (Conc.)	L	G	L	L	L	L	G	-	-	-	-
Hydrogen Peroxide (Dil.)	L	G	L	G	G	G	G	-	-	-	-
Hydrogen Sulfide	G	G	G	G	G	G	P	-	G	G	G
Iodine	L	G	G	G	G	L	L	-	G	G	G
Kerosene (2)	L	L	L	G	G	L	L	-	G	G	G
Ketones	G	G	G	G	G	P	P	-	G	G	G
Lacquer Solvents	L	L	L	G	G	P	-	-	L	G	G
Lactic Acid	G	G	G	G	G	G	G	-	G	G	G
Lead Acetate	G	G	G	G	G	G	G	-	G	G	G
Linseed Oil	L	G	G	G	G	L	G	-	G	G	G
Magnesium Salts	G	G	G	G	G	G	G	-	-	-	G
Naphtha	L	L	L	G	G	P	L	G	G	G	G
Natural Gas	L	L	L	G	G	G	G	-	2	2	2
Nickel Salts	G	G	G	G	G	G	G	-	-	-	-
Nitric Acid (Conc.)	P	L	P	P	P	L	P	G	L	L	G
Nitric Acid (Dil.)	P	G	L	L	L	G	P	P	L	L	G
Nitrobenzene	P	L	G	L	L	P	P	P	G	G	G
Nitrogen Oxides	L	L	G	L	L	G	-	-	-	-	-
Nitrous Acid	L	L	G	L	L	G	L	-	G	G	G
Oils (Animal and Mineral)	L	L	L	G	G	L	G	-	G	G	G
Oils (Vegetable)	L	L	L	G	G	L	G	-	G	G	G
Oxygen (5) (6)	G	G	G	G	G	G	G	G	G	G	G
Perchloric Acid	P	G	L	P	P	L	P	P	L	G	G
Phenols	P	G	G	P	P	L	P	P	-	-	G
Potassium Salts	G	G	G	G	G	G	G	G	-	-	-
Pyridine	L	L	L	L	L	P	P	-	G	G	G
Silver Nitrate	G	G	G	G	G	G	G	G	G	G	G
Soap Solutions	G	G	G	G	G	G	G	G	G	G	G
Sodium Salts	G	G	G	G	G	G	G	G	-	-	-
Stearic Acid	L	L	L	G	G	P	L	-	G	G	G
Sulfur Chloride	L	L	P	L	L	L	-	-	G	G	G
Sulfuris Acid (Conc.)	P	G	G	P	P	L	P	P	-	-	-
Sulfuris Acid (Dil.)	P	G	G	L	L	G	L	P	-	-	-
Sulfurous Acid	P	G	L	L	L	G	L	P	G	G	G

(Cont.)

For detailed ordering information, please consult price list or contact Parflex® Division.

Parker Hannifin Corporation | Parflex® Division | Ravenna, Ohio | parker.com/pfd

www.comoso.com



G-57

A Hose

B Tubing

C Coiled Air Hose & Fittings

D Transportation

E Fittings

F Tooling, Equipment & Accessories

G General Technical

Media to Plastic Tubing Material Compatibility Guide (cont.)

Media	PE	HDPE	PP	N	NR	PV	U	PEFR	FEP	PFA	TFE
Tannic Acid	G	G	G	G	G	G	P	-	G	G	G
Tanning Extracts	G	G	G	G	G	G	P	-	-	-	-
Titanium Salts	G	G	G	G	G	G	G	G	-	-	-
Toluene	P	L	P	G	G	P	L	P	G	G	G
Trichloroacetic Acid	L	L	L	P	P	P	P	-	-	-	-
Trichloroethylene	P	L	P	L	L	P	P	P	G	G	G
Turpentine	P	P	L	G	G	L	L	-	G	G	G
Urea	G	G	G	G	G	G	G	-	G	L	G
Uric Acid	G	G	G	G	G	G	G	-	G	G	G
Water (6)	G	G	G	G	G	G	G	G	G	G	G
Xylene	P	L	P	G	G	P	P	P	G	G	G
Zinc Chloride	G	G	G	G	G	G	G	-	G	L	G

Notes:

- The Fluid Compatibility Guides are simplified rating tabulations based on immersion tests at 75°F. Higher temperatures tend to reduce ratings. Since final selection depends on pressure, fluid and ambient temperature and other factors not known to Parker Hannifin Co., no performance guarantee is expressed or implied. Ratings do not imply compliance with specialized codes such as FDA, NSF, AGA or UL and do not cover possible fluid discoloration, taste or odor effects. For conveying foodstuffs use FDA sanctioned materials, and for potable water use NSF listed materials. For chemicals not listed, or for advice on particular applications, please consult Product Engineering, Parflex Div., Ravenna, Ohio.
- Hose applications for these fluids must take into account legal and insurance regulations. This does not imply AGA or UL compliance.
- Satisfactory at some concentrations and temperatures, unsatisfactory in others.
- For high pressure gases, the cover should be pinpricked and the pressure must not be released quickly. Chain or restrain the hose to prevent personal injury in the event of damage or failure.
- Chemical compatibility does not imply low permeation rates. Consult the Parker factory for a suggestion for your specific requirement.
- Does not imply NSF or FDA compliance.
- Chemical compatibility does not imply acceptability for use in airless paint spray applications. These applications require a special conductive hose.
- Fluoropolymers are chemically compatible with Anhydrous Ammonia. However, extreme caution must be used in dealing with Anhydrous Ammonia since it can cause severe injuries such as blindness and/or chemical burns.

Metric Conversion Chart

English to Metric			
	To Convert From	To	Multiply By
Area	Sq. in. (in ²)	Sq. mm (mm ²)	645.16
	Sq. in. (in ²)	Sq. cm (cm ²)	6.4516
	Sq. ft. (ft ²)	Sq. meters (m ²)	0.0929
Density	Pounds/Cubic foot (lb./ft ³)	Kilograms/Cubic meter (kg/m ³)	16.02
Energy	British thermal units (Btu) (1 J=Ws=0.2388 cal)	Joules (J)	1055
Force	Pounds – force (lbf) (1N=0.102 kgf)	Newtons (N)	4.448
Length	Inches (in)	Milimeters (mm)	25.4
	Feet (ft)	Meters (m)	0.3048
	Miles (mi)	Kilometers (km)	1.609
Mass (Weight)	Ounces (oz.)	Grams (g)	28.35
	Pounds – mass (lb)	Kilograms (kg)	0.4536
	Short tons (2000 lb) (tn)	Metric tons (100 kg) (t)	0.9072
Power	Horsepower (550 ft lb/s) (hp)	Kilowatts (kW)	0.7457
Pressure	Pounds/square inch (psi)	Kilograms (f)/square cm (kg(f)/cm ²)	0.7457
		Kilopascals (kPa)	0.0703
		Bars (100 kPa)	6.8948
Stress	Pounds/square inch (psi) (1N/mm ² =1MPa)	megapascals (MPa)	0.006895
Temperature	Degrees Fahrenheit (°F)	Degrees Celsius (°C)	5/9 (after subtracting 32)
Torque or Bending Moment	Pounds-force-foot (lb-ft)	Newtons-meter (Nm)	1.3567
	Pounds-force-inch (lb-in)		0.113
Velocity	Feet/second (ft/s)	Meters/second (m/s)	0.3048
Viscosity	Dynamic (centipoise)	Pascal-second (Pas)	.001
	Denematic – foot ² /sec (ft ² /s)	Meter ² /sec (m ² /s)	0.0929
Volume	Cubic inch (in ³)	Cubic centimeter (cm ³) (milliliter)	16.3871
	Quarts (qt)	Liters (1000 cm ³)	0.9464
	Gallons (gal)	Liters	3.7854

Metric to English			
To Convert From	To	Multiply By	
Sq. mm (mm ²)	Sq. in. (in ²)	0.00155	
Kilograms/Cubic meter (kg/m ³)	Pounds/Cubic foot (lb./ft ³)	0.0624	
Joules (J)	British Thermal Units (Btu)	0.000947	
Newtons (N)	Pounds - force (lbf)	0.2248	
Milimeters (mm)	Inches (in)	0.03937	
Meters (m)	Feet (ft)	3.281	
Kilometers (km)	Miles (mi)	0.621	
Grams (g)	Ounces (oz.)	0.035	
Kilograms (kg)	Pounds - mass (lb)	2.205	
Metric tons (100 kg) (t)	Short tons (2000 lb) (tn)	1.102	
Kilowatts (kW)	Horsepower (550 ft lb/s) (hp)	1.341	
Kilograms (f)/square cm (kg(f)/cm ²)	Pounds/square inch (psi)	14.22	
		Kilopascals (kPa)	0.145
		Bars (100 kPa)	14.503
megapascals (MPa)	Pounds/square inch (psi) (1N/mm ² =1MPa)	145.039	
Degrees Celsius (°C)	Degrees Fahrenheit (°F)	9/5 (then add 32)	
Newtons-meter (Nm)	Pounds-force-foot (lb-ft)	0.737	
	Pounds-force-inch (lb-in)	8.85	
Meters/second (m/s)	Feet/second (ft/s)	3.2808	
Pascal-second (Pas)	Dynamic (centipoise)	1000	
Meter ² /sec (m ² /s)	Denematic - foot ² /sec (ft ² /s)	10.7643	
Cubic centimeter (cm ³) (milliliter)	Cubic inch (in ³)	0.061	
Liters (1000 cm ³)	Quarts (qt)	1.057	
Liters	Gallons (gal)	0.2642	

For detailed ordering information, please consult price list or contact Parflex® Division.

Parker Hannifin Corporation | Parflex® Division | Ravenna, Ohio | parker.com/pfd

www.comoso.com



G-59

A Hose

B Tubing

C Coiled Air Hose & Fittings

D Transportation

E Fittings

F Tooling, Equipment & Accessories

G General Technical

Government & Agency Specifications

Agency and Specifications	Parflex Products
Flame Resistance:	
MSHA	83FR, D6, D6R, HFS, HFSR, HFS2, HFS2R, HTB, HTBR, M8, 560, 563, 593, 590, (except-3), 510A (except -4, -5, -6), 510C (except -4), 515H, 520N, 540N, 56DH-2, 560R, 573X-3, 575X, 580N, HLB, HJK
UL94V-2	PEFR, HUFR
UL94HB	83FR NN, NB, NNR, NBR (wall thickness above 0.033", contact Parflex for availability)
VW1, UL-83	All PFA, FEP & PTFE tubing products
Food Contact:	
FDA, CFR21 Part 177	E, F64, PP, PV, 540P, 919, 919J, 919U, 929, 939, S30, S40, STW, SBFW, SCW, PCW, SCWW, PCWW, PCWF-FS, SCWF-FS, RCTW, All natural and black PFA, FEP, PTFE & PVDF tubing products
NSF Standard 51*	E, F64, PP, NTNA, Series Tubing
Potable Water:	
NSF Standard 61*	E Series Tubing
Natural Gas Service:	
For Vehicles and Dispensing Systems ANSI IAS NGV4.2 - CSA 12.52 - NFPA 52	5CNG
European Safety Standard (TUV) Kraftfahrt-Bundesamt ECE R110	5CNG-3, 5CNG-8 (Assemblies from Parker Polyflex Europe Only)
Hydraulic Service:	
SAE 100R1	HFS, HFSR, 560, 560R
SAE 100R2	590, 593, HFS2
SAE 100R7	540N, 540P, 548N, 510C(less-2), 518C, 518D, 55LT, 510C(less-2), 943B
SAE 100R8	520N, 528N, 580N, 588N
SAE 100R12	M8
SAE 100R14A	919, 919J, 919U, 929, S30, S40
SAE 100R14B	919B, 929B, 929BJ, S30B, S40B
SAE 100R16	HFS2, HFS2R, 590
SAE 100R17	D6, D6R, H6, R6, 563, 943B
SAE 100R18	53DM, 538DM
WASTEC WRP05:	
Waste Equipment Technology Association	S5N, S6, S9, SLH
Transportation Standards:	
SAE J844, FMVSS106 (49CFR571.106)	1120A, 1120B, BRAKCOIL®, Dollycoil™, Duo-Coil™, SliderCoil™
Electrical, Non-Conductivity:	
SAE J517	518C, 518D, 548N, 528N, 588N, 538DM
DNV (with approved fittings only)	
Det Norske (Norwegian) Veritas Marine Steel Ships, Mobile Offshore & Fixed Offshore Drilling Units	520N, 580N, 588N, H580N, 518C, 540N, 573X, 575X, 590, 593, 560, 560R
American Bureau of Shipping (ABS) Product Design Assessment:	590 (sizes -4, -6, -8), 593
Breathing Air Applications:	
CGA (Compressed Gas Association)-G-7.1 Grade E Breathing Air	526BA, 527BA
NFPA 1901	526BA, 527BA

*Indicates that products shown have been tested and certified by NSF International to the requirements of NSF Standards 51 and 61. NSF does not express or imply an approval on any product.

Agency and Specifications	Parflex Products
Aerospace Material Specifications:	
AMS 3584A	HS2TFI
AMS 3585	HS2TFT
AMS 3586	HS2TFS
AMS 3653E	101, 201, TFS, TFL, TFH, TFT, HS2TFS, HS2TFT, HS2TFL, HS2TFI, TSWTF, CV (PTFE), CVL, CVH, 81914/1, 81914/2
AMS 3654C	TFL
AMS 3655B	TFT
MIL-DTL-27267C	PTFE Conductive Tubing
AMS-DTL-23053/11A CLASS 1	HS1.3FEP
AMS-DTL-23053/11A CLASS 2	HS1.6FEP
AMS-DTL-23053/12A CLASS 1	HS2TFH
AMS-DTL-23053/12A CLASS 2	HS2TFS
AMS-DTL-23053/12A CLASS 3	HS2TFT
AMS-DTL-23053/12A CLASS 4	HS2TFL
AMS-DTL-23053/12A CLASS 5	HS2TFI
SAE AS81914/1	81914/1
SAE AS81914/2	81914/2
SAE AS81914/3	81914/3
SAE AS81914/4	81914/4
American Society for Testing and Materials:	
ASTM D1710, TYPE 1, GRADE 1, CLASS B	TFB
ASTM D2116-07	103, 203
ASTM D2902 TYPE 1	HS2TFS, HS2TFT, HS2TFL, HS2TFI, HS2TFH
ASTM D2902 TYPE II	HS1.3FEP, HS1.6FEP, HS1.25FEP
ASTM D3222	110, 111
ASTM D3295	TFB, TSWTF
ASTM D3295, Class 1	TFL
ASTM D3295, Class 2	TFT
ASTM D3295, Class 3	TFS
ASTM D3295, Class 4	TFH
ASTM D3296-03	HS1.3FEP, HS1.6FEP, CV (FEP), 81914/3, 81914/4, CR (FEP), 703
ASTM D3307-10	104, 204, 105, 205, CR (PFA), 704, 705
Canadian Standards Association:	
CSA 9032-01 300V	TFT (awg)
CSA 9032-01 600V	TFS (awg)
Military Standard - US Department of Defense:	
MIL-I-22129C	TFS
A-A-59602	TSWTF
Underwriters Laboratories:	
UL-224 150V 200°C	TFL (awg)
UL-224 300V 200°C	TFT (awg)
UL-224 600V 200°C	TFS (awg)
United States Pharmacopoeia:	
USP Class VI	101, 201, TFS, TFL, TFH, TFT, TFB, HS2TFS, HS2TFT, HS2TFL, HS2TFI, HS2TFH, CV, CVL, CVH, 103, 203, HS1.3FEP, HS1.6FEP, CR, 104, 204, 105, 205



For detailed ordering information, please consult price list or contact Parflex® Division.

Parker Safety Guide

For selecting and using Hose, Tubing, Fittings, and Related Accessories



Parker Safety Guide for Selecting and Using Hose, Tubing, Fittings and Related Accessories
Publication No. 4400-B.1
Revised: November 2007

WARNING: Failure or improper selection or improper use of hose, tubing, fittings, assemblies or related accessories ("Products") can cause death, personal injury and property damage. Possible consequences of failure or improper selection or improper use of these Products include but are not limited to:

- Fittings thrown off at high speed.
- High velocity fluid discharge.
- Explosion or burning of the conveyed fluid.
- Electrocution from high voltage electric powerlines.
- Contact with suddenly moving or falling objects that are controlled by the conveyed fluid.

- Injections by high-pressure fluid discharge.
- Dangerously whipping Hose.
- Contact with conveyed fluids that may be hot, cold, toxic or otherwise injurious.
- Sparking or explosion caused by static electricity buildup or other sources of electricity.
- Sparking or explosion while spraying paint or flammable liquids.
- Injuries resulting from inhalation, ingestion or exposure to fluids.

Before selecting or using any of these Products, it is important that you read and follow the instructions below. Only Hose from Parker's Stratoflex Products Division is approved for in flight aerospace applications.

1.0 GENERAL INSTRUCTIONS

1.1 Scope: This safety guide provides instructions for selecting and using (including assembling, installing, and maintaining) these Products. For convenience, all rubber and/or thermoplastic products commonly called "hose" or "tubing" are called "Hose" in this safety guide. All assemblies made with Hose are called "Hose Assemblies". All products commonly called "fittings", "couplings" or "adapters" are called "Fittings". All related accessories (including crimping and swaging machines and tooling) are called "Related Accessories". This safety guide is a supplement to and is to be used with the specific Parker publications for the specific Hose, Fittings and Related Accessories that are being considered for use. Parker publications are available at www.parker.com. SAE J1273 (www.sae.org) and ISO 17165 2 (www.ansi.org) also provide recommended practices for hydraulic Hose Assemblies.

1.2 Fail-Safe: Hose, Hose Assemblies and Fittings can and do fail without warning for many reasons. Design all systems and equipment in a fail safe mode, so that failure of the Hose, Hose Assembly or Fitting will not endanger persons or property.

1.3 Distribution: Provide a copy of this safety guide to each person responsible for selecting or using Hose and Fitting products. Do not select or use Parker Hose or Fittings without thoroughly reading and understanding this safety guide as well as the specific Parker publications for the Products.

1.4 User Responsibility: Due to the wide variety of operating conditions and applications for Hose and Fittings, Parker does not represent or warrant that any particular Hose or Fitting is suitable for any specific end use system. This safety guide does not analyze all technical parameters that must be considered in selecting a product. The user, through its own analysis and testing, is solely responsible for:

- Making the final selection of the Products.
- Assuring that the user's requirements are met and that the application presents no health or safety hazards.
- Providing all appropriate health and safety warnings on the equipment on which the Products are used.
- Assuring compliance with all applicable government and industry standards.

1.5 Additional Questions: Call the appropriate Parker technical service department if you have any questions or require any additional information. See the Parker publication for the Products being considered or used, or call 1 800 CPARKER, or go to www.parker.com, for telephone numbers of the appropriate technical service department.

2.0 HOSE AND FITTING SELECTION INSTRUCTIONS

2.1 Electrical Conductivity: Certain applications require that the Hose be nonconductive to prevent electrical current flow. Other applications require the Hose and the Fittings and the Hose/Fitting interface to be sufficiently conductive to drain off static electricity. Extreme care must be exercised

when selecting Hose and Fittings for these or any other applications in which electrical conductivity or nonconductivity is a factor.

The electrical conductivity or nonconductivity of Hose and Fittings is dependent upon many factors and may be susceptible to change. These factors include but are not limited to the various materials used to make the Hose and the Fittings, Fitting finish (some Fitting finishes are electrically conductive while others are nonconductive), manufacturing methods (including moisture control), how the Fittings contact the Hose, age and amount of deterioration or damage or other changes, moisture content of the Hose at any particular time, and other factors.

The following are considerations for electrically nonconductive and conductive Hose. For other applications consult the individual catalog pages and the appropriate industry or regulatory standards for proper selection.

2.1.1 Electrically Nonconductive Hose: Certain applications require that the Hose be nonconductive to prevent electrical current flow or to maintain electrical isolation. For applications that require Hose to be electrically nonconductive, including but not limited to applications near high voltage electric lines, only special nonconductive Hose can be used. The manufacturer of the equipment in which the nonconductive Hose is to be used must be consulted to be certain that the Hose and Fittings that are selected are proper for the application. Do not use any Parker Hose or Fittings for any such application requiring nonconductive Hose, including but not limited to applications near high voltage electric lines, unless (i) the application is expressly approved in the Parker technical publication for the product, (ii) the Hose is marked "nonconductive", and (iii) the manufacturer of the equipment on which the Hose is to be used specifically approves the particular Parker Hose and Fittings for such use.

2.1.2 Electrically Conductive Hose: Parker manufactures special Hose for certain applications that require electrically conductive Hose.

Parker manufactures special Hose for conveying paint in airless paint spraying applications. This Hose is labeled "Electrically Conductive Airless Paint Spray Hose" on its layline and packaging. This Hose must be properly connected to the appropriate Parker Fittings and properly grounded in order to dissipate dangerous static charge buildup, which occurs in all airless paint spraying applications. Do not use any other Hose for airless paint spraying, even if electrically conductive. Use of any other Hose or failure to properly connect the Hose can cause a fire or an explosion resulting in death, personal injury, and property damage.

Parker manufactures a special Hose for certain compressed natural gas ("CNG") applications where static electricity buildup may occur. Parker CNG Hose assemblies comply with the requirements of ANSI/IAS NGV 4.2-1999; CSA 12.52-M99, "Hoses for Natural Gas Vehicles and Dispensing Systems" (www.ansi.org). This Hose is labeled "Electrically Conductive for CNG Use" on its layline and packaging. This Hose must be properly connected to the appropriate Parker Fittings and properly grounded in order to dissipate dangerous static charge buildup, which occurs in, for example, high velocity CNG

For detailed ordering information, please consult price list or contact Parflex® Division.

Parker Hannifin Corporation | Parflex® Division | Ravenna, Ohio | parker.com/pfd

www.comoso.com



G-61

A
Hose

B
Tubing

C
Coiled Air Hose
& Fittings

D
Transportation

E
Fittings

F
Tooling, Equipment
& Accessories

G
General Technical

dispensing or transfer. Do not use any other Hose for CNG applications where static charge buildup may occur, even if electrically conductive. Use of other Hoses in CNG applications or failure to properly connect or ground this Hose can cause a fire or an explosion resulting in death, personal injury, and property damage. Care must also be taken to protect against CNG permeation through the Hose wall. See section 2.6, Permeation, for more information. Parker CNG Hose is intended for dispenser and vehicle use at a maximum temperature of 180°F (82°C). Parker CNG Hose should not be used in confined spaces or unventilated areas or areas exceeding 180°F (82°C). Final assemblies must be tested for leaks. CNG Hose Assemblies should be tested on a monthly basis for conductivity per ANSI/IAS NGV 4.2-1999; CSA 12.52-M99.

Parker manufactures special Hose for aerospace in flight applications. Aerospace in flight applications employing Hose to transmit fuel, lubricating fluids and hydraulic fluids require a special Hose with a conductive inner tube. This Hose for in flight applications is available only from Parker's Stratoflex Products Division. Do not use any other Parker Hose for in flight applications, even if electrically conductive. Use of other Hoses for in flight applications or failure to properly connect or ground this Hose can cause a fire or an explosion resulting in death, personal injury and property damage. These Hose assemblies for in flight applications must meet all applicable aerospace industry, aircraft engine and aircraft requirements.

2.2 Pressure: Hose selection must be made so that the published maximum working pressure of the Hose and Fittings are equal to or greater than the maximum system pressure. The maximum working pressure of a Hose Assembly is the lower of the respective published maximum working pressures of the Hose and the Fittings used. Surge pressures or peak transient pressures in the system must be below the published maximum working pressure for the Hose. Surge pressures and peak pressures can usually only be determined by sensitive electrical instrumentation that measures and indicates pressures at millisecond intervals. Mechanical pressure gauges indicate only average pressures and cannot be used to determine surge pressures or peak transient pressures. Published burst pressure ratings for Hose is for manufacturing test purposes only and is no indication that the Product can be used in applications at the burst pressure or otherwise above the published maximum recommended working pressure.

2.3 Suction: Hoses used for suction applications must be selected to insure that the Hose will withstand the vacuum and pressure of the system. Improperly selected Hose may collapse in suction application.

2.4 Temperature: Be certain that fluid and ambient temperatures, both steady and transient, do not exceed the limitations of the Hose. Temperatures below and above the recommended limit can degrade Hose to a point where a failure may occur and release fluid. Properly insulate and protect the Hose Assembly when routing near hot objects (e.g. manifolds). Do not use any Hose in any application where failure of the Hose could result in the conveyed fluids (or vapors or mist from the conveyed fluids) contacting any open flame, molten metal, or other potential fire ignition source that could cause burning or explosion of the conveyed fluids or vapors.

2.5 Fluid Compatibility: Hose Assembly selection must assure compatibility of the Hose tube, cover, reinforcement, and Fittings with the fluid media used. See the fluid compatibility chart in the Parker publication for the product being considered or used. This information is offered only as a guide. Actual service life can only be determined by the end user by testing under all extreme conditions and other analysis. Hose that is chemically compatible with a particular fluid must be assembled using Fittings and adapters containing likewise compatible seals.

2.6 Permeation: Permeation (that is, seepage through the Hose) will occur from inside the Hose to outside when Hose is used with gases, liquid and gas fuels, and refrigerants (including but not limited to such materials as helium, diesel fuel, gasoline, natural gas, or LPG). This permeation may result in high concentrations of vapors which are potentially flammable, explosive, or toxic, and in loss of fluid. Dangerous explosions, fires, and other hazards can result when using the wrong Hose for such applications. The system designer must take into account the fact that this permeation will take place and must not use Hose if this permeation could be hazardous. The system designer must take into account all legal, government, insurance, or any other special regulations which govern the use of fuels and refrigerants. Never use a Hose even though the fluid compatibility is acceptable without considering the potential hazardous effects that can result from permeation through the Hose Assembly.

Permeation of moisture from outside the Hose to inside the Hose will also occur in Hose assemblies, regardless of internal pressure. If this moisture permeation would have detrimental effects (particularly, but not limited to refrigeration and air conditioning systems), incorporation of sufficient drying capacity in the system or other appropriate system safeguards should be selected and used.

2.7 Size: Transmission of power by means of pressurized fluid varies with pressure and rate of flow. The size of the components must be adequate to keep pressure losses to a minimum and avoid damage due to heat generation or excessive fluid velocity.

2.8 Routing: Attention must be given to optimum routing to minimize inherent problems (kinking or flow restriction due to Hose collapse, twisting of the Hose, proximity to hot objects or heat sources). For additional routing recommendations see SAE J1273 and ISO 17165-2. Hose Assemblies have a finite life and if possible, should be installed in a manner that allows for ease of inspection and future replacement. Rubber Hose because of its relative short life, should not be used in residential and commercial buildings for HVAC (heating, ventilating and air conditioning) applications.

2.9 Environment: Care must be taken to insure that the Hose and Fittings are either compatible with or protected from the environment (that is, surrounding conditions) to which they are exposed. Environmental conditions including but not limited to ultraviolet radiation, sunlight, heat, ozone, moisture, water, salt water, chemicals and air pollutants can cause degradation and premature failure.

2.10 Mechanical Loads: External forces can significantly reduce Hose life or cause failure. Mechanical loads which must be considered include excessive flexing, twist, kinking, tensile or side loads, bend radius, and vibration. Use of swivel type Fittings or adapters may be required to insure no twist is put into the Hose. Unusual applications may require special testing prior to Hose selection.

2.11 Physical Damage: Care must be taken to protect Hose from wear, snagging, kinking, bending smaller than minimum bend radius and cutting, any of which can cause premature Hose failure. Any Hose that has been kinked or bent to a radius smaller than the minimum bend radius, and any Hose that has been cut or is cracked or is otherwise damaged should be removed and discarded.

2.12 Proper End Fitting: See instructions 3.2 through 3.5. These recommendations may be substantiated by testing to industry standards such as SAE J517 for hydraulic applications, or MIL-A-5070, AS1339, or AS3517 for Hoses from Parker's Stratoflex Products Division for aerospace applications.

2.13 Length: When establishing a proper Hose length, motion absorption, Hose length changes due to pressure, and Hose and machine tolerances and movement must be considered.

2.14 Specifications and Standards: When selecting Hose and Fittings, government, industry, and Parker specifications and recommendations must be reviewed and followed as applicable.

2.15 Hose Cleanliness: Hose components may vary in cleanliness levels. Care must be taken to insure that the Hose Assembly selected has an adequate level of cleanliness for the application.

2.16 Fire Resistant Fluids: Some fire resistant fluids that are to be conveyed by Hose require use of the same type of Hose as used with petroleum base fluids. Some such fluids require a special Hose, while a few fluids will not work with any Hose at all. See instructions 2.5 and 1.5. The wrong Hose may fail after a very short service. In addition, all liquids but pure water may burn fiercely under certain conditions, and even pure water leakage may be hazardous.

2.17 Radiant Heat: Hose can be heated to destruction without contact by such nearby items as hot manifolds or molten metal. The same heat source may then initiate a fire. This can occur despite the presence of cool air around the Hose.

2.18 Welding or Brazing: When using a torch or arc welder in close proximity to hydraulic lines, the hydraulic lines should be removed or shielded with with appropriate fire resistant materials. Flame or weld spatter could

burn through the Hose and possibly ignite escaping fluid resulting in a catastrophic failure. Heating of plated parts, including Hose Fittings and adapters, above 450°F (232°C) such as during welding, brazing or soldering may emit deadly gases.

2.19 Atomic Radiation: Atomic radiation affects all materials used in Hose assemblies. Since the long-term effects may be unknown, do not expose Hose assemblies to atomic radiation.

2.20 Aerospace Applications: The only Hose and Fittings that may be used for in-flight aerospace applications are those available from Parker's Stratoflex Products Division. Do not use any other Hose or Fittings for in-flight applications. Do not use any Hose or Fittings from Parker's Stratoflex Products Division with any other Hose or Fittings, unless expressly approved in writing by the engineering manager or chief engineer of Stratoflex Products Division and verified by the user's own testing and inspection to aerospace industry standards.

2.21 Unlocking Couplings: Ball locking Couplings or other Fittings with quick disconnect ability can unintentionally disconnect if they are dragged over obstructions, or if the sleeve or other disconnect member is bumped or moved enough to cause disconnect. Threaded Fittings should be considered where there is a potential for accidental uncoupling.

3.0 HOSE AND FITTINGS ASSEMBLY AND INSTALLATION INSTRUCTIONS

3.1 Component Inspection: Prior to assembly, a careful examination of the Hose and Fittings must be performed. All components must be checked for correct style, size, catalog number, and length. The Hose must be examined for cleanliness, obstructions, blisters, cover looseness, kinks, cracks, cuts or any other visible defects. Inspect the Fitting and sealing surfaces for burrs, nicks, corrosion or other imperfections. Do NOT use any component that displays any signs of nonconformance.

3.2 Hose and Fitting Assembly: Do not assemble a Parker Fitting on a Parker Hose that is not specifically listed by Parker for that Fitting, unless authorized in writing by the engineering manager or chief engineer of the appropriate Parker division. Do not assemble a Parker Fitting on another manufacturer's Hose or a Parker Hose on another manufacturer's Fitting unless (i) the engineering manager or chief engineer of the appropriate Parker division approves the Assembly in writing or that combination is expressly approved in the appropriate Parker literature for the specific Parker product, and (ii) the user verifies the Assembly and the application through analysis and testing. For Parker Hose that does not specify a Parker Fitting, the user is solely responsible for the selection of the proper Fitting and Hose Assembly procedures. See instruction 1.4.

To prevent the possibility of problems such as leakage at the Fitting or system contamination, it is important to completely remove all debris from the cutting operation before installation of the Fittings. The Parker published instructions must be followed for assembling the Fittings on the Hose. These instructions are provided in the Parker Fitting catalog for the specific Parker Fitting being used, or by calling 1-800-CPARKER, or at www.parker.com.

3.3 Related Accessories: Do not crimp or swage any Parker Hose or Fitting with anything but the listed swage or crimp machine and dies in accordance with Parker published instructions. Do not crimp or swage another manufacturer's Fitting with a Parker crimp or swage die unless authorized in writing by the engineering manager or chief engineer of the appropriate Parker division.

3.4 Parts: Do not use any Parker Fitting part (including but not limited to socket, shell, nipple, or insert) except with the correct Parker mating parts, in accordance with Parker published instructions, unless authorized in writing by the engineering manager or chief engineer of the appropriate Parker division.

3.5 Field Attachable/Permanent: Do not reuse any field attachable Hose Fitting that has blown or pulled off a Hose. Do not reuse a Parker permanent Hose Fitting (crimped or swaged) or any part thereof. Complete Hose Assemblies may only be reused after proper inspection under section 4.0. Do not assemble Fittings to any previously used hydraulic Hose that was in service, for use in a fluid power application.

3.6 Pre-Installation Inspection: Prior to installation, a careful examination of the Hose Assembly must be performed. Inspect the Hose Assembly for any damage or defects. DO NOT use any Hose Assembly that displays any signs of nonconformance.

3.7 Minimum Bend Radius: Installation of a Hose at less than the minimum listed bend radius may significantly reduce the Hose life. Particular attention must be given to preclude sharp bending at the Hose to Fitting juncture. Any bending during installation at less than the minimum bend radius must be avoided. If any Hose is kinked during installation, the Hose must be discarded.

3.8 Twist Angle and Orientation: Hose Assembly installation must be such that relative motion of machine components does not produce twisting.

3.9 Securement: In many applications, it may be necessary to restrain, protect, or guide the Hose to protect it from damage by unnecessary flexing, pressure surges, and contact with other mechanical components. Care must be taken to insure such restraints do not introduce additional stress or wear points.

3.10 Proper Connection of Ports: Proper physical installation of the Hose Assembly requires a correctly installed port connection insuring that no twist or torque is transferred to the Hose when the Fittings are being tightened or otherwise during use.

3.11 External Damage: Proper installation is not complete without insuring that tensile loads, side loads, kinking, flattening, potential abrasion, thread damage or damage to sealing surfaces are corrected or eliminated. See instruction 2.10.

3.12 System Checkout: All air entrapment must be eliminated and the system pressurized to the maximum system pressure (at or below the Hose maximum working pressure) and checked for proper function and freedom from leaks. Personnel must stay out of potential hazardous areas while testing and using.

3.13 Routing: The Hose Assembly should be routed in such a manner so if a failure does occur, the escaping media will not cause personal injury or property damage. In addition, if fluid media comes in contact with hot surfaces, open flame or sparks, a fire or explosion may occur. See section 2.4.

3.14 Ground Fault Equipment Protection Devices (GFEPDs): *WARNING!* Fire and Shock Hazard. To minimize the danger of fire if the heating cable of a Multitube bundle is damaged or improperly installed, use a Ground Fault Equipment Protection Device. Electrical fault currents may be insufficient to trip a conventional circuit breaker.

For ground fault protection, the IEEE 515:1989 (www.ansi.org) standard for heating cables recommends the use of GFEPDs with a nominal 30 milliampere trip level for "piping systems in classified areas, those areas requiring a high degree of maintenance, or which may be exposed to physical abuse or corrosive atmospheres".

4.0 HOSE AND FITTING MAINTENANCE AND REPLACEMENT INSTRUCTIONS

4.1 Even with proper selection and installation, Hose life may be significantly reduced without a continuing maintenance program. The severity of the application, risk potential from a possible Hose failure, and experience with any Hose failures in the application or in similar applications should determine the frequency of the inspection and the replacement for the Products so that Products are replaced before any failure occurs. A maintenance program must be established and followed by the user and, at minimum, must include instructions 4.2 through 4.7.

4.2 Visual Inspection Hose/Fitting: Any of the following conditions require immediate shut down and replacement of the Hose Assembly:

- Fitting slippage on Hose;
- Damaged, cracked, cut or abraded cover (any reinforcement exposed);
- Hard, stiff, heat cracked, or charred Hose;
- Cracked, damaged, or badly corroded Fittings;
- Leaks at Fitting or in Hose;
- Kinked, crushed, flattened or twisted Hose; and
- Blistered, soft, degraded, or loose cover.

4.3 Visual Inspection All Other: The following items must be tightened, repaired, corrected or replaced as required:

- Leaking port conditions;
- Excess dirt buildup;
- Worn clamps, guards or shields; and
- System fluid level, fluid type, and any air entrapment.

For detailed ordering information, please consult price list or contact Parflex® Division.

Parker Hannifin Corporation | Parflex® Division | Ravenna, Ohio | parker.com/pfd

www.comoso.com



G-63

A
Hose

B
Tubing

C
Coiled Air Hose
& Fittings

D
Transportation

E
Fittings

F
Tooling, Equipment
& Accessories

G
General Technical

4.4 Functional Test: Operate the system at maximum operating pressure and check for possible malfunctions and leaks. Personnel must avoid potential hazardous areas while testing and using the system. See section 2.2.

4.5 Replacement Intervals: Hose assemblies and elastomeric seals used on Hose Fittings and adapters will eventually age, harden, wear and deteriorate under thermal cycling and compression set. Hose Assemblies and elastomeric seals should be inspected and replaced at specific replacement intervals, based on previous service life, government or industry recommendations, or when failures could result in unacceptable downtime, damage, or injury risk. See section 1.2. Hose and Fittings may be subjected to internal mechanical and/or chemical wear from the conveying fluid and may fail without warning. The user must determine the product life under such circumstances by testing. Also see section 2.5.

4.6 Hose Inspection and Failure: Hydraulic power is accomplished by utilizing high pressure fluids to transfer energy and do work. Hoses, Fittings and Hose Assemblies all contribute to this by transmitting fluids at high pressures. Fluids under pressure can be dangerous and potentially lethal and, therefore, extreme caution must be exercised when working with fluids under pressure and handling the Hoses transporting the fluids. From time to time, Hose Assemblies will fail if they are not replaced at proper time intervals. Usually these failures are the result of some form of misapplication, abuse, wear or failure to perform proper maintenance. When Hoses fail, generally the high pressure fluids inside escape in a stream which may or may not be visible to the user. Under no circumstances should the user attempt to locate the leak by “feeling” with their hands or any other part of their body. High pressure fluids can and will penetrate the skin and cause severe tissue damage and possibly loss of limb. Even seemingly minor hydraulic fluid injection injuries must be treated immediately by a physician with knowledge of the tissue damaging properties of hydraulic fluid.

If a Hose failure occurs, immediately shut down the equipment and leave the area until pressure has been completely released from the Hose Assembly. Simply shutting down the hydraulic pump may or may not eliminate the pressure in the Hose Assembly. Many times check valves, etc., are employed in a system and can cause pressure to remain in a Hose Assembly even when pumps or equipment are not operating. Tiny holes in the Hose, commonly known as pinholes, can eject small, dangerously powerful but hard to see streams of hydraulic fluid. It may take several minutes or even hours for the pressure to be relieved so that the Hose Assembly may be examined safely.

Once the pressure has been reduced to zero, the Hose Assembly may be taken off the equipment and examined. It must always be replaced if a failure has occurred. Never attempt to patch or repair a Hose Assembly that has failed. Consult the nearest Parker distributor or the appropriate Parker division for Hose Assembly replacement information.

Never touch or examine a failed Hose Assembly unless it is obvious that the Hose no longer contains fluid under pressure. The high pressure fluid is extremely dangerous and can cause serious and potentially fatal injury.

4.7 Elastomeric seals: Elastomeric seals will eventually age, harden, wear and deteriorate under thermal cycling and compression set. Elastomeric seals should be inspected and replaced.

4.8 Refrigerant gases: Special care should be taken when working with refrigeration systems. Sudden escape of refrigerant gases can cause blindness if the escaping gases contact the eye and can cause freezing or other severe injuries if it contacts any other portion of the body.

4.9 Compressed natural gas (CNG): Parker CNG Hose Assemblies should be tested after installation and before use, and at least on a monthly basis per ANSI/IAS NGV 4.2-1999; CSA 12.52-M99 Section 4.2 “Visual Inspection Hose/Fitting”. The recommended procedure is to pressurize the Hose and check for leaks and to visually inspect the Hose for damage. Caution: Matches, candles, open flame or other sources of ignition shall not be used for Hose inspection. Leak check solutions should be rinsed off after use.

5.0 HOSE STORAGE

5.1 Age Control: Hose and Hose Assemblies must be stored in a manner that facilitates age control and first-in and first-out usage based on manufacturing date of the Hose and Hose Assemblies. The shelf life of rubber Hose or Hose Assemblies that have passed visual inspection and a proof test is 10 years (40 quarters) from the date of manufacture. The shelf life of thermoplastic and polytetrafluoroethylene Hose or Hose Assemblies is considered to be unlimited.

5.2 Storage: Stored Hose and Hose Assemblies must not be subjected to damage that could reduce their expected service life and must be stored in a cool, dark and dry area with the ends capped. Stored Hose and Hose Assemblies must not be exposed to temperature extremes, ozone, oils, corrosive liquids or fumes, solvents, high humidity, rodents, insects, ultraviolet light, electromagnetic fields or radioactive materials.



For detailed ordering information, please consult price list or contact Parflex® Division.

ENERPAC Warranty Policy

For those ENERPAC items sold as part of the Parker Parflex Division product offering, the following warranty applies.

ENERPAC products are warranted to be free of defects in materials and workmanship under normal use for as long as they are owned by the original purchaser, subject to the exclusions and limitations described below. This warranty does not cover ordinary wear and tear, overloading, alterations, (including repairs or attempted repairs by parties other than ENERPAC or its authorized service representatives), improper fluid, use in a manner for which they are not intended or use which is contrary to instructions for the products.

THIS WARRANTY IS LIMITED TO NEW PRODUCTS SOLD THROUGH ENERPAC AUTHORIZED DISTRIBUTORS, ORIGINAL EQUIPMENT MANUFACTURERS OR OTHER DESIGNATED CHANNELS OF DISTRIBUTION. NO AGENT, EMPLOYEE, OR OTHER REPRESENTATIVE OF ENERPAC HAS THE AUTHORITY TO IN ANY WAY CHANGE OR AMEND THIS WARRANTY.

Electronic products and components are warranted against defects in material and workmanship for a period of two years from the date of purchase.

The following items supplied with ENERPAC products are excluded from this warranty:

Components not manufactured by ENERPAC, including air motors, electric motors, gasoline engines, and diesel engines. Such items are warranted to the extent of the warranty provided by the manufacturers of such items.

If the customer believes a product is defective, the product must be delivered, or shipped freight prepaid, to the nearest ENERPAC Authorized Service Center. The customer should contact ENERPAC to locate and Authorized Service Center in the customer's area.

Products that do not conform to this warranty will be returned by ground transportation, freight prepaid.

THE FOREGOING WARRANTY IS EXCLUSIVE AND IS IN LIEU OF ALL OTHER EXPRESS AND IMPLIED WARRANTIES, INCLUDING BUT NOT LIMITED TO THE IMPLIED WARRANTIES OF MERCHANTABILITY AND FITNESS FOR A PARTICULAR PURPOSE.

The remedy of repair, replacement or refund is customer's exclusive remedy in the event of breach of this warranty.

SELLER SHALL NOT BE SUBJECT TO AND DISCLAIMS:

- (a) ANY OTHER OBLIGATIONS OR LIABILITIES ARISING OUT OF BREACH OF CONTRACT OR OF WARRANTY,
- (b) ANY OBLIGATIONS WHATSOEVER ARISING FROM TORT CLAIMS (INCLUDING NEGLIGENCE AND STRICT LIABILITY) OR ARISING UNDER THEORIES OR LAW WITH RESPECT TO PRODUCTS SOLD OR SERVICES RENDERED BY SELLER OR ANY UNDERTAKINGS, ACTS OR OMISSIONS RELATING THERETO, AND
- (c) ALL CONSEQUENTIAL, INCIDENTAL AND CONTINGENT DAMAGES WHATSOEVER.

ENERPAC's liability in all cases is limited to, and shall not exceed, the purchase price paid.

For the nearest authorized ENERPAC SERVICE CENTER, please call ENERPAC at 1-800-558-0530 or visit the ENERPAC web site at www.Enerpac.com.

For detailed ordering information, please consult price list or contact Parflex® Division.

Parker Hannifin Corporation | Parflex® Division | Ravenna, Ohio | parker.com/pfd

www.comoso.com



G-65

A
Hose

B
Tubing

C
Coiled Air Hose
& Fittings

D
Transportation

E
Fittings

F
Tooling, Equipment
& Accessories

G
General Technical

Offer of Sale

The items described in this document and other documents or descriptions provided by Parker Hannifin Corporation, as subsidiaries and its authorized distributors are hereby offered for sale at prices to be established by Parker Hannifin Corporation, its subsidiaries and its authorized distributors. This offer and its acceptance by any customer ("Buyer") shall be governed by all of the following Terms and Conditions. Buyer's order for any such item, when communicated to Parker Hannifin Corporation, its subsidiary or an authorized distributor ("Seller") verbally or in writing, shall constitute acceptance of this offer.

1. Terms and Conditions of Sale: All descriptions, quotations, proposals, offers, acknowledgments, acceptances and sales of Seller's products are subject to and shall be governed exclusively by the terms and conditions stated herein. Buyer's acceptance of any offer to sell is limited to these terms and conditions. Any terms or conditions in addition to, or inconsistent with those stated herein, proposed by Buyer in any acceptance of an offer by Seller, are hereby objected to. No such additional, different or inconsistent terms and conditions shall become part of the contract between Buyer and Seller unless expressly accepted in writing by Seller. Seller's acceptance of any offer to purchase by Buyer is expressly conditional upon Buyer's assent to all the terms and conditions stated herein, including any terms in addition to, or inconsistent with those contained in Buyer's offer. Acceptance of Seller's products shall in all events constitute such assent.
2. Payment: Payment shall be made by Buyer net 30 days from the date of delivery of the items purchased hereunder. Any claims by Buyer for omissions or shortages in a shipment shall be waived unless Seller receives notice thereof within 30 days after Buyer's receipt of the shipment.
3. Delivery: Unless otherwise provided on the face hereof, delivery shall be made F.O.B. Seller's plant. Regardless of the method of delivery, however, risk of loss shall pass to Buyer upon Seller's delivery to a carrier. Any delivery dates shown are approximate only and Seller shall have no liability for any delays in delivery.
4. Warranty: Seller warrants that the items sold thereunder shall be free from defects in material or workmanship for a period of 365 days from the date of shipment to Buyer, or 2,000 hours of use, whichever expires first. THIS WARRANTY COMPRISES THE SOLE AND ENTIRE WARRANTY PERTAINING TO ITEMS PROVIDED HEREUNDER. SELLER MAKES NO OTHER WARRANTY, GAURANTEE, OR REPRESENTATION OF ANY KIND WHATSOEVER. ALL OTHER WARRANTIES, INCLUDING BUT NOT LIMITED TO, MERCHANTABILITY AND FITNESS FOR PURPOSE, WHETHER EXPRESS, IMPLIED, OR ARISING BY OPERATION OF LAW, TRADE USAGE, OR COURSE OF DEALING ARE HEREBY DISCLAIMED. NOTWITHSTANDING THE FOREGOING, THERE ARE NO WARRANTIES WHATSOEVER ON ITEMS BUILT OR ACQUIRED WHOLELY OR PARTIALLY, TO BUYER'S DESIGNS OR SPECIFICATIONS.
5. Limitation Of Remedy: SELLER'S LIABILITY ARISING FROM OR IN ANY WAY CONNECTED WITH THE ITEMS SOLD OR THIS CONTRACT SHALL BE LIMITED EXCLUSIVELY TO REPAIR OR REPLACEMENT OF THE ITEMS SOLD OR REFUND OF THE PURCHASE PRICE PAID BY BUYER, AT SELLER'S SOLE OPTION. IN NO EVENT SHALL SELLER BE LIABLE FOR ANY INCIDENTAL, CONSEQUENTIAL OR SPECIAL DAMAGES OF ANY KIND OR NATURE WHATSOEVER, INCLUDING BUT NOT LIMITED TO LOST PROFITS ARISING FROM OR IN ANY WAY CONNECTED WITH THIS AGREEMENT OR ITEMS SOLD HEREUNDER, WHETHER ALLEGED TO ARISE FROM BREACH OF CONTRACT, EXPRESS OR IMPLIED WARRANTY, OR IN TORT, INCLUDING WITHOUT LIMITATION, NEGLIGENCE, FAILURE TO WARN OR STRICT LIABILITY.
6. Changes, Reschedules and Cancellations: Buyer may request to modify the designs or specifications for the items sold hereunder as well as the quantities and delivery dates thereof, or may request to cancel all or part of this order, however, no such requested modification or cancellation shall become part of the contract between Buyer and Seller unless accepted by Seller in a written amendment to this Agreement. Acceptance of any such requested modification or cancellation shall be at Seller's discretion, and shall be upon such terms and conditions as Seller may require.
7. Special Tooling: A tooling charge may be imposed for any special tooling, including without limitation, dies, fixtures, molds and patterns, acquired to manufacture items sold pursuant to this contract. Such special tooling shall be and remain Seller's property notwithstanding payment of any charges by Buyer. In no event will Buyer acquire any interest in apparatus belonging to Seller which is utilized in the manufacture of the items sold hereunder, even if such apparatus has been specially converted or adapted for such manufacture and notwithstanding any charges paid by Buyer. Unless otherwise agreed, Seller shall have the right to alter, discard or otherwise dispose of any special tooling or other property in its sole discretion at any time.
8. Buyer's Property: Any designs, tools, patterns, materials, drawings, confidential information or equipment furnished by Buyer or any other items which become Buyer's property, may be considered obsolete and may be destroyed by Seller after two (2) consecutive years have elapsed without Buyer placing an order for the items which are manufactured using such property. Seller shall not be responsible for any loss or damage to such property while it is in Seller's possession or control.
9. Taxes: Unless otherwise indicated on the face hereof, all prices and charges are exclusive of excise, sales, use, property, occupational or like taxes which may be imposed by any taxing authority upon the manufacture, sale or delivery of the items sold hereunder. If any such taxes must be paid by Seller of if Seller is liable for the collection of such tax, the amount thereof shall be in addition to the amounts for the items sold. Buyer agrees to pay all such taxes or to reimburse Seller therefore upon receipt of its invoice. If Buyer claims exemption from any sales, use or other tax imposed by any taxing authority, Buyer shall save Seller harmless from and against any such tax, together with any interest or penalties thereon which may be assessed if the items are held to be taxable.
10. Indemnity For Infringement of Intellectual Property Rights: Seller shall have no liability for infringement of any patents, trademarks, copyrights, trade dress, trade secrets or similar rights except as provided in this Part 10. Seller will defend and indemnify Buyer against allegations of infringement of U.S. patents, U.S. trademarks, copyrights, trade dress and trade secrets (hereinafter "Intellectual Property Rights"). Seller will defend at its expense and will pay the cost of any settlement or damages awarded in an action brought against Buyer based on an allegation that an item sold pursuant to this contract infringes in the Intellectual Property Rights of a third party. Seller's obligation to defend and indemnify Buyer is contingent on Buyer notifying Seller within ten (10) days after Buyer becomes aware of such allegations of infringement, and Seller having sole control over the defense of any allegations or actions including all negotiations for settlement or compromise. If an item sold hereunder is subject to a claim that it infringes the Intellectual Property Rights of a third party, Seller may, at its sole expense and options, procure for Buyer the right to continue using said item, replace or modify said item so as to make it noninfringing, or offer to accept return of said item and return the purchase price less a reasonable allowance for depreciation. Notwithstanding the foregoing, Seller shall have no liability for claims of infringement based on information provided by Buyer, or directed to items delivered hereunder for which the designs are specified in whole or part by Buyer, or infringements resulting from the modification, combination or use in a system of any item sold hereunder. The foregoing provisions of this Part 10 shall constitute Seller's sole and exclusive liability and Buyer's sole and exclusive remedy for infringement of Intellectual Property Rights. If a claim is based on information provided by Buyer or if the design for an item delivered hereunder is specified in whole or in part by Buyer, Buyer shall defend and indemnify Seller for all costs, expenses or judgments resulting from any claim that such item infringes any patent, trademark, copyright, trade dress, trade secret or any similar right.
11. Force Majeure: Seller does not assume the risk of and shall not be liable for delay or failure to perform any of Seller's obligations by reason of circumstances beyond the reasonable control of Seller (hereinafter "Events of Force Majeure"). Events of Force Majeure shall include without limitation, accidents, acts of God, strikes or labor disputes, acts, laws, rules or regulations of any government or government agency, fires, floods, delays or failures in delivery of carriers or suppliers, shortages of materials and any other cause beyond Seller's control.
12. Entire Agreement/Governing Law: The terms and conditions set forth herein, together with any amendments, modifications and any different terms or conditions expressly accepted by Seller in writing, shall constitute the entire Agreement concerning the items sold, and there are no oral or other representations or agreements which pertain thereto. This Agreement shall be governed in all respects by the law of the State of Ohio. No actions arising out of the sale of the items sold hereunder or this Agreement may be brought by either party more than two (2) years after the cause of action accrues.



Part Number Index

Part Number	Page	Part Number	Page	Part Number	Page
015301.....	F-5 : F-13	10654.....	E-9	129HY.....	E-116
015302.....	F-8 : F-9	10655.....	E-16	13491N.....	E-76
015303.....	F-8 : F-9	10656.....	E-39	134HY.....	E-116
015304.....	F-8 : F-9	10657.....	E-58	134MS.....	E-125
015305.....	F-8 : F-9	10658.....	E-16	13754.....	E-10
015306.....	F-6, F-8	10658H.....	E-62	13755.....	E-20
015307.....	F-6	10691N.....	E-74	13756.....	E-42
015308.....	F-6	10691NRD.....	E-74	13954.....	E-10
015309.....	F-5	10693N.....	E-87	13757.....	E-59
015310.....	F-8 : F-9	10694.....	E-90	13758.....	E-20
015411.....	F-8 : F-9	10695.....	E-90	13758H.....	E-62
015412.....	F-8 : F-9	106CY.....	E-102	13791N.....	E-76
015413.....	F-8 : F-9	106HY.....	E-111	13793N.....	E-88
015414.....	F-8 : F-9	106LV.....	E-124	137HY.....	E-116
015415.....	F-8 : F-9	106SF.....	E-105	13955.....	E-21
025349.....	F-6, F-9	10755.....	E-17	13956.....	E-42
025399.....	F-5, F-9, F-13	10756.....	E-40	13957.....	E-59
045234.....	F-7 : F-9	10758.....	E-17	13958.....	E-21
062***.....	C-20	10791N.....	E-75	13958H.....	E-63
072***.....	C-20	107HY.....	E-112	13991N.....	E-77
090.....	E-71	10855.....	E-17	13993N.....	E-88
101-(PTFE).....	B-54	10856.....	E-40	139CY.....	E-103
10155.....	E-13	10858.....	E-17	139HY.....	E-117
10156.....	E-37	10891N.....	E-75	13D55.....	E-34
10157.....	E-58	108HY.....	E-112	13D58.....	E-34
10158.....	E-13	108MS.....	E-125	13DHY.....	E-120
10158H.....	E-62	10C56.....	E-49	13E55.....	E-15
10191N.....	E-73	10GHY.....	E-113	13E56.....	E-41
10193N.....	E-87	10LHY.....	E-113	13E58.....	E-15
101CY.....	E-102	110-(PVDF).....	B-102	14155.....	E-22
101HY.....	E-108	111-(PVDF).....	B-102	14156.....	E-43
101SF.....	E-105	11155.....	E-18	14158.....	E-22
101SQ.....	E-127	11158.....	E-18	14191N.....	E-77
10255.....	E-14	11192.....	E-85	141HY.....	E-117
10256.....	E-37	11C56.....	E-49	14956.....	E-44
10258.....	E-14	111HY.....	E-114	14K93N.....	E-88
102CY.....	E-102	1120-.....	D-4	15555.....	E-23
102HY.....	E-109	11255.....	E-18	15858.....	E-23
103-(FEP).....	B-82	11256.....	E-40	16191N.....	E-78
10355.....	E-14	11258.....	E-18	16755.....	E-23
10356.....	E-38	11355.....	E-19	16756.....	E-43
10358.....	E-14	11356.....	E-41	16758.....	E-23
1035A.....	A-56	11357.....	E-59	16791N.....	E-78
1035HT.....	A-57	11358.....	E-19	16792.....	E-86
10391N.....	E-73	113CY.....	E-103	167HY.....	E-118
103HY.....	E-109	113HY.....	E-114	16955.....	E-24
104-(PFA).....	B-98	11D55.....	E-33	16956.....	E-43
105-(H.P. PFA).....	B-100	11D58.....	E-33	16958.....	E-24
10455.....	E-15	11L55.....	E-19	16991N.....	E-79
10456.....	E-38	11L58.....	E-19	16992.....	E-86
10458.....	E-15	11LHY.....	E-115	169HY.....	E-118
10555.....	E-16	12891N.....	E-75	17791N.....	E-79
10556.....	E-39	12892.....	E-85		
10558.....	E-16	128HY.....	E-115		
105HY.....	E-110				

For detailed ordering information, please consult price list or contact Parflex® Division.

Parker Hannifin Corporation | Parflex® Division | Ravenna, Ohio | parker.com/pfd

www.comoso.com



Part Number Index (cont.)

Part Number	Page	Part Number	Page	Part Number	Page
177HY	E-118	1G255	E-30	1JS58H	E-63
17991N	E-79	1G258	E-30	1JBSF	E-106
179HY	E-119	1GJHY	E-120	1JSHY	E-123
		1GKCY	E-103	1JSSF	E-106
19255	E-34	1GK91N	E-103		
19256	E-50	1GU55	E-29	1L955	E-22
19258	E-34	1GU58	E-29	1L956	E-44
19291N	E-84			1L958	E-22
193HY	E-119	1HUSQ	E-127	1LMCY	E-104
1AL55	E-28	1J055	E-25	1MU55	E-29
1AL56	E-49	1J056	E-46	1MU58	E-29
1AL58	E-28	1J058	E-25		
1AL91N	E-80	1J0HY	E-123	1P691N	E-80
		1J155	E-26		
1B155	E-35	1J156	E-46	1Q191N	E-83
1B156	E-50	1J158	E-26		
1B158	E-35	1J158H	E-64	1TFMS	E-126
1B255	E-35	1J191N	E-81	1TU55	E-27
1B256	E-51	1J1HY	E-121	1TU56	E-48
1B258	E-35	1J256	E-46	1TU58	E-27
1B291N	E-84	1J556	E-47	1TU91N	E-83
1B456	E-51	1J754	E-9		
		1J755	E-27	1UT55	E-28
1C356	E-52	1J756	E-47	1UT58	E-28
1C456	E-52	1J757	E-60		
1C556	E-53	1J758	E-27	1WU54	E-11
1C655	E-31	1J758H	E-64	1WW54	E-10
1C656	E-53	1J791N	E-81	1WY54	E-11
1C658	E-31	1J793N	E-89		
1C955	E-31	1J7HY	E-121	20090	E-71
1C956	E-54	1J954	E-9	201-(Metric FTFE)	B-57
1C958	E-31	1J955	E-278	20151	E-5
1CA56	E-54	1J956	E-48	20190	E-66
1CE56	E-55	1J957	E-60	201BA	E-99
1CF56	E-55	1J958	E-27	201BU	E-100
		1J958H	E-64	203-(Metric FEP)	B-83
1D055	E-32	1J991N	E-82	20351	E-6
1D056	E-56	1J993N	E-89	204-(Metric PFA)	B-99
1D058	E-32	1J9CY	E-104	205-(Metric H.P. PFA)	B-101
1D0HY	E-119	1J9HY	E-122	20651	E-6
1D255	E-32	1JBSF	E-106	20690	E-66
1D256	E-56	1JC54	E-8	206BA	E-99
1D258	E-32	1JC55	E-25	206BU	E-100
1D955	E-33	1JC56	E-45	20851	E-7
1D956	E-57	1JC57	E-60	20890	E-67
1D958	E-33	1JC58	E-25	208MS	E-126
1D9HY	E-120	1JC58H	E-63	213BU	E-100
		1JC91N	E-82	22890	E-67
1FN91N	E-80	1JC93N	E-89	23490	E-67
1FU55	E-29	1JCCY	E-104	23790	E-68
1FU58	E-29	1JCHY	E-122	23951	E-7
		1JS55	E-24	23990	E-68
1G155	E-30	1JS56	E-45	24398	F-17
1G158	E-30	1JS58	E-24	2613	F-20



For detailed ordering information, please consult price list or contact Parflex® Division.

Parker Hannifin Corporation | Parflex® Division | Ravenna, Ohio | parker.com/pfd

www.comoso.com

Part Number Index (cont.)

Part Number	Page	Part Number	Page	Part Number	Page
2625.....	F-20	731512-Blue, Red	D-7	85C-CHD-PFD.....	F-11
26190.....	E-69	731513-Blue, Red	D-7	85C-KKB-PFD.....	F-11
26790.....	E-69	731516.....	D-7	85C-R01-PFD.....	F-11
26990.....	E-70	731522.....	D-7	85C-R02-PFD.....	F-11
2740.....	F-20	731611-Blue, Red	D-7	85C-STD-PFD.....	F-10 : F-11
27790.....	E-70	731612-Blue, Red	D-7	881540-PFD.....	F-17
2799.....	F-20	741526.....	D-7	8PC-030-PFD.....	F-16
27990.....	E-70	741590-Blue, Red	D-7	8PC-00P-PFD.....	F-16
2TFMS.....	E-126	751597.....	D-7		
		751634.....	D-9	919.....	A-68, F-20
332T-115V-PFD.....	F-17	751641.....	D-7	919B.....	A-68
3PSG.....	F-19	751655.....	D-7	919J.....	A-69
		751656-Blk.....	D-7	919U.....	A-70
510A.....	A-38	751657.....	D-10	929/929B.....	A-71
510C.....	A-39	751658-Blue, Red	D-10	929BJ.....	A-72
515H.....	A-42	751659.....	D-10	939.....	A-73, F-20
518C.....	A-40	751660-Blue, Red	D-10	939B.....	A-73
518D.....	A-41	771164.....	D-10	943B.....	A-74, F-20
520N.....	A-43			944B.....	A-75
526BA.....	A-44	801048.....	D-8	94C-080-PFD.....	F-5
527BA.....	A-45	801595.....	D-8	94C-001-PFD.....	F-5
528N.....	A-43	801632.....	D-8	94C-002-PFD.....	F-5
53DM/538DM.....	A-46	80C-061-PFD.....	F-10	94C-MKS.....	F-7
540N.....	A-47	80C-0DR-PFD.....	F-15	950B.....	A-76
540P.....	A-48	80C-SDR.....	F-15	955B.....	A-77
548N.....	A-67	811537.....	D-11		
55LT.....	A-49	81914/1.....	B-80	A0.....	C-8
55AG.....	F-19, F-21	81914/3.....	B-92	AS-Y.....	F-20
55SG.....	F-19, F-21	81C-R01-PFD.....	F-16	AHUF5.....	C-17
55SSG.....	F-19	81C-R02-PFD.....	F-16	AUFS.....	C-15
5PSG.....	F-19	822011.....	F-8 : F-9		
56DH/568DH.....	A-50	822012.....	F-8 : F-9	B9.....	A-58
560/560R.....	A-34	822031.....	F-8 : F-9		
563.....	A-35	82C-061L-PFD.....	F-10	CL-S.....	E-93
569.....	A-51	82C-OAP-PFD.....	F-13	CNG.....	A-59
573X.....	A-52	82C-OEP-PFD.....	F-14	CNGG.....	F-18
575X.....	A-53	82C-OHP-PFD.....	F-14	CR.....	B-95
580661.....	F-17	82C-CHD-PFD.....	F-10	CV.....	B-76, B-90
580N/588N.....	A-54	82C-KKB-PFD.....	F-10	CVL.....	B-78
590.....	A-36	82C-R01-PFD.....	F-5, F-8, F-10	CVH.....	B-78
593.....	A-37	82C-R02-PFD.....	F-10		
5CNG.....	A-59	83C-080-PFD.....	F-12	D6.....	A-22
5CNG/CNGLT.....	F-18	83C-081-PFD.....	F-12	D6R.....	A-23
		83C-0CB-PFD.....	F-12		
6 CTX-S.....	F-8	83C-0DR-PFD.....	F-15	E/EB.....	B-10 : B-13
6-2 CTX-S.....	F-9	83C-R02-PFD.....	F-12	E-S.....	E-93
6-6 CTX-S.....	F-8 : F-9	83C-R02H-PFD.....	F-12		
60 HAB.....	E-71	83C-S40-PFD.....	F-12	F64.....	B-30
61 HAB.....	E-71	83C-S20-PFD.....	F-12	FBS-S.....	E-93
68NTA.....	D-11	83FR.....	A-55	FC.....	C-11
685RA.....	E-11	85C-00L-PFD.....	F-10 : F-11	FIL-S.....	E-94
		85C-061L-PFD.....	F-11	FJX-S.....	E-96
703.....	B-96	85C-OHP-PFD.....	F-14	FL.....	C-11
704.....	B-96	85C-OEP-PFD.....	F-14	FN.....	C-12
705.....	B-96	85C-1PH-PFD.....	F-10 : F-11	FORFS-S.....	E-96

For detailed ordering information, please consult price list or contact Parflex® Division.

Parker Hannifin Corporation | Parflex® Division | Ravenna, Ohio | parker.com/pfd

www.comoso.com



Part Number Index (cont.)

Part Number	Page	Part Number	Page	Part Number	Page
FP-S	E-95	PAT	B-22	TUBE-S	E-97
FR	C-12	PC300	E-92	U	B-34
FS	C-9	PCW/PCB	A-83	UC	C-12
G64	B-28	PCWV/PCBV	A-85	UM	B-36
GH9211	D-7 : D-9	PCWV-FS/PCBV-FS	A-87	UFS	C-16
GH9212	D-7 : D-9	PEFR	B-15	VBL	F-14
H580N	A-54	PF ANSI Flange	E-97	VBS	F-14
H6	A-28	PFT	D-5		
HBR	F-18	PLCF-S	E-96		
HDPE	B-16	PP/PPB	B-32		
HFS	A-24	PSG	F-23		
HFSR	A-25	PTC	F-17		
HFS2	A-26	PTC-001-RB	F-17		
HFS2R	A-27	PTH	A-62		
HJK	A-33	PV (guard)	F-18, F-20, F-22		
HLB	A-60	PV (tubing)	B-44		
HS1.25FEP	B-88	R6	A-29		
HS1.3FEP	B-84	RC300	E-92		
HS1.6FEP	B-86	RCTW/RCTB	A-88		
HS2TFI	B-68	S30/S30B	A-78		
HS2TFL, AWG	B-70	S40/S40B	A-79		
HS2TFL, Fractional	B-68	S5N	A-63		
HS2TFS, AWG	B-70	S6	A-64		
HS2TFS, Fractional	B-68	S9	A-65		
HS2TFT, AWG	B-70	SAN-S	E-98		
HS2TFT, Fractional	B-68	SB	C-20		
HS4TFI	B-74	SBF300	E-92		
HTB	A-30	SBFW/SBFB	A-81		
HTBR	A-31	SC300	E-92		
HTC	F-17	SCW/SCB	A-82		
HTFL	D-6	SCWV/SCBV	A-84		
HU	B-40	SCWV-FS/SCBV-FS	A-86		
HUFR	B-38	SFR-S	E-97		
HUM	B-42	SG	C-13, F-22		
M8	A-32	SLH	A-66		
MBS-S	E-94	SQ-101-sw	F-13		
MC	C-10	SQ Mender	F-13		
MCB	C-18	ST300	E-92		
ME	C-10	ST301	E-92		
MG	F-20	STW/STB	A-80		
MIL-S	E-94	TFB	B-65		
ML	C-11	TFH, AWG	B-60		
MLB	C-19	TFL, AWG	B-60		
MP-S	E-95	TFL, Fractional	B-58		
MSAN-S	E-98	TFS, AWG	B-60		
MSH	A-61	TFS, Fractional	B-58		
N/NB	B-18 : B-21	TFT, AWG	B-60		
NBR	B-24	TFT, Fractional	B-58		
NN	B-18 : B-20	TH11-1-PFD	F-17		
NNR	B-24 : B-25	TH8-1-XXX	F-14		
NR	B-24	TH9-1-XXX	F-14		
NTNA	B-26	TS	C-13		
		TSSL/TSSS	B-89		
		TSWTF	B-66		



For detailed ordering information, please consult price list or contact Parflex® Division.

Parker Hannifin Corporation | Parflex® Division | Ravenna, Ohio | parker.com/pfd

www.comoso.com

Key Word Index

Keyword	Page	Keyword	Page	Keyword	Page
1.25/1 Heat Shrink	B-88	Duraflex	A-67	NoMar Fast-Stor Assy	C-14, C-17
1.3/1 Heat Shrink	B-84	DuraGard	A-55	NoMar Fast-Stor Coils	C-16
1.67/1 Heat Shrink	B-86	Duramax	A-46	NoMar Fast-Stor Fittings	C-18 : C-19
2 : 1 Heat Shrink	B-68 : B-73	E-Z Flex	A-32	Nylon Air Brake Tubing	D-4
4 : 1 Heat Shrink	B-74	Electrical Insulation	B-49	Nylon Tubing	B-18 : B-26
51 Series	E-5	Eliminator	A-30, A-31	PAGE Fittings	E-91
54 Series	E-8	Fast Response Hose	A-52, A-53	PAGE-flex SBF	A-81
55 Series	E-12	Fast-Stor Air Hose	C-8 : C-9, C-14 : C-19	Parkrimp Dies	F-15
56 Series	E-36	Fast-Stor		Parkrimp 2	F-12
57 Series	E-58	Fittings	C-10 : C-14, C-19	Parprene Tubing	B-28
58 Series	E-12	FEP Heat Shrink	B-84 : B-89	Partek Sleeve	F-20
58H Series	E-61	FEP Tubing	B-82 : B-95	PFA Tubing	B-98 : B-101
90 Series	E-65	Field Att. Fitting	E-2	Polyethylene Tubing	B-10 : B-16
91N/91 Series	E-72	Fifth Wheel Slider	D-11	Polypropylene Tubing	B-32
92 Series	E-85	Fire-Screen	A-24 : A-27	Polyurethane Tubing	B-34 : B-42
93N Series	E-87	Fire Sleeve	F-20	Predator	A-63 : A-65
94 Series	E-90	Flange	E-80, E-88, E-97, E-98	PTFE Heat Shrink	B-68 : B-74
95 Series	E-90	Flange Retainer	E-97	PTFE Hose	A-68 : A-78
Air Brake Tubing	D-4	Flare-Seal Hose	A-84, A-85	PTFE Tubing	B-54 : B-80
Air Hose	C-4 : C-21	Flex Tubing	B-103	Pumps (Crimpers)	F-13
A-Lok Fitting	E-28, E-60, E-76 : E-77	Fluoropolymer Tubing	B-48 : B-103	Pure Air Tubing	B-22
Abrasion King	A-29	Gates Conversion Kit	F-16	PVDF Tubing	B-102 : B-103
Adapters	E-11	Guards	F-18 : F-22	Rapid Assy Fitting	E-10 : E-11
Anti-Kink Casing	F-20	Harnesses	D-12	Refrigerant Hose	A-38
Armor Guard	F-19, F-21	Heat Shrink Tubing	B-68 : B-74, B-84 : B-89	Replacement Parts (FA Fitting)	E-XX
AWG Tubing	B-60 : B-64	Heavy Wall		Replacement Parts (MiniKrimp)	F-8
BA Series	E-99	Hose	A-71, A-79, A-84, A-85	Retractable Coiled Tubing	B-96
Beading	B-65	High Density Tubing	B-16	Roll Cover	B-88
Bend Restrictor	F-18	High Pressure Hose	A-33, A-45	Rubber Covered Hose	A-88
Brakcoil	D-7	A-51, A-54, A-74 : A-77	SCR Hose	D-13
Breathing Air Hose	A-44, A-45	High Purity Tubing	B-22, B-98	Sewer Hose	A-58 : A-62
BU Series	E-100	Highjack	A-33	SF Series	E-105
Bundles	D-12	Hose Cutter	F-17	Sleeve	F-20
Clear Vinyl Hose Guard	F-21, F-23	Hose Guard	F-18 : F-22	SliderCoil	D-10
Clear Vinyl Tubing	B-44	HY Series	E-107	Spaghetti Tubing	B-60
Collars	E-92	Hybrid Hose	A-22, A-23, A-25 : A-33	Spring, External & Internal	F-20
Convuluted Tubing		Hydraulic Press Kit	F-16	Spring Guard	F-19 : F-21
.....	B-76 : B-81; B-90 : B-93	I-Line Fitting	E-94	SQ Series	E-127
Crimp Fitting	E-2	Insertion Block	F-14	Super-Flex Tubing	B-103
Crimpers	F-5, F-10 : F-12	Jackline Hose	A-33	Superbraid	C-20 : C-21
Conversion Kits	F-16	Karrykrimp	F-10	Swager	F-13
Convuluted Hose	A-73, A-82 : A-83	Karrykrimp 2	F-11	Table Mount	F-6
Corrugated Tubing	B-95	LV Series	E-124		
Cut-off Tools	F-17	Marine Hose	A-61, A-62		
CY Series	E-101	Microweld Tubing	B-38		
Die Racks	F-15	MiniKrimp	F-5		
Dies	F-15	Mounts	F-6		
Diesel Fuel Tubing	D-5, D-6	MS Series	E-125		
Duo-Coil	D-8				
DollyCoil	D-9				
Double Shrink	B-89				

see next page for Technical Data

For detailed ordering information, please consult price list or contact Parflex® Division.

Parker Hannifin Corporation | Parflex® Division | Ravenna, Ohio | parker.com/pfd

www.comoso.com



Key Word Index (cont.)

Keyword	Page	Keyword	Page	Keyword	Page
Technical Data		TOOLING			
AIR HOSE		Swage Specification, (Sewer Hose) G-42			
Air Hose Size Selection	C-5	TUBING			
Fast-Stor, Measuring Bulk Hose	C-6 : C-7	Compatibility Chart for Fittings..... B-6			
Fast-Stor, How To Assemble	C-13	Fluoropolymer Quick Reference. B-50			
		Fluoropolymer Chemical Resistance..... B-50			
		Fluoropolymer Property Comparison B-51			
		Fluoropolymer Nomenclature B-52			
FITTINGS		Media to Plastic Tubing			
Standard Fitting Configurations by		Material Guide G-55 : G-57			
Connection & End Code	E-4	Metal Tube & Fitting			
Ferrul-Fix Installation	G-41	Material Guide G-47 : G-48			
Fitting Nomenclature.....	E-3	Pressure Ranges..... B-9			
Media to Fitting &					
Seal Compatibility	G-45 : G-46	Thermoplastic Hose A-22 : A-64			
Metals Corrosion Scale	G-50	True-Bore Hose..... A-77			
Nomar Fast-Stor Assy Instruction	C-19	Tube Cutter F-17			
O-Ring Material Selection Guide	G-49				
		Ultra-Lite Superbraid C-20 : C-21			
HOSE		Ultrapure Tubing B-20, B-100			
Die Selection /Crimp/Swage	G-42				
Hose Assembly & Crimping	G-13 : G-35	Vise Blocks F-14			
Hose Assembly Part Number	12	Vise Mount..... F-6			
Hose Construction/Specifications		Vinyl Tubing B-44			
psi	A-9 : A-13	Weatherhead Conversion Kit F-16			
Hose Construction/Specifications					
MPa.....	A-14 : A-17				
Hose Diameter Selection.....	G-5				
Hose Fitting Insertion Values	G-43				
Hose Fitting Thread Guide	G-44				
Hose Permeation Data	G-8				
Hose Nomenclature					
Thermoplastic Hose	A-18				
Hose Nomenclature					
Parflex PTFE Hose.....	A-19				
Hose Nomenclature					
Parflex PAGE Hose	A-20 : A-21				
Hose Selection, Inst. & Mtn.	G-10				
Hose, Volumetric Expansion	G-6 : G-7				
Media to Hose					
Material Compatibility	G-52 : G-55				
Stamped Form	11				
Swage Instructions (Sewer Hose) ...	G-36 : G-39				
Twin/Multi-Line Separation	G-27				
Understanding Parflex Hose	A-7				
OTHER					
Government/Agency Specifications	G-60				
Materials to Parflex Part Number.....	G-51				
Metric Conversion Chart	G-59				

Parker's Motion & Control Product Groups

At Parker, we're guided by a relentless drive to help our customers become more productive and achieve higher levels of profitability by engineering the best systems for their requirements. It means looking at customer applications from many angles to find new ways to create value. Whatever the motion and control technology need, Parker has the experience, breadth of product and global reach to consistently deliver. No company knows more about motion and control technology than Parker. For further info call 1 800 C-Parker (1 800 272 7537).



Aerospace

Key Markets

Aftermarket services
Commercial transports
Engines
General & business aviation
Helicopters
Launch vehicles
Military aircraft
Missiles
Power generation
Regional transports
Unmanned aerial vehicles

Key Products

Control systems & actuation products
Engine systems & components
Fluid conveyance systems & components
Fluid metering, delivery & atomization devices
Fuel systems & components
Fuel tank inerting systems
Hydraulic systems & components
Thermal management
Wheels & brakes



Automation

Key Markets

Alternative energy
Conveyor & material handling
Factory automation
Food & beverage
Life sciences & medical
Machine tools
Packaging machinery
Paper machinery
Plastics machinery
Primary metals
Safety & security
Semiconductor & electronics
Transportation & automotive

Key Products

AC/DC drives & systems
Air preparation
Electric actuators, gantry robots & slides
Human machine interfaces
Inverters
Manifolds
Miniature fluidics
Pneumatic actuators & grippers
Pneumatic valves & controls
Rotary actuators
Stepper motors, servo motors, drives & controls
Structural extrusions
Vacuum generators, cups & sensors



Climate & Industrial Controls

Key Markets

Agriculture
Air conditioning
Construction Machinery
Food & beverage
Industrial machinery
Life sciences
Oil & gas
Precision cooling
Process
Refrigeration
Transportation

Key Products

Accumulators
Advanced actuators
CO₂ controls
Electronic controllers
Filter driers
Hand shut-off valves
Heat exchangers
Hose & fittings
Pressure regulating valves
Refrigerant distributors
Safety relief valves
Smart pumps
Solenoid valves
Thermostatic expansion valves



Filtration

Key Markets

Aerospace
Food & beverage
Industrial plant & equipment
Life sciences
Marine
Mobile equipment
Oil & gas
Power generation & renewable energy
Process
Transportation
Water Purification

Key Products

Analytical gas generators
Compressed air filters & dryers
Engine air, coolant, fuel & oil filtration systems
Fluid condition monitoring systems
Hydraulic & lubrication filters
Hydrogen, nitrogen & zero air generators
Instrumentation filters
Membrane & fiber filters
Microfiltration
Sterile air filtration
Water desalination & purification filters & systems



Fluid Connectors

Key Markets

Aerial lift
Agriculture
Bulk chemical handling
Construction machinery
Food & beverage
Fuel & gas delivery
Industrial machinery
Life sciences
Marine
Mining
Mobile
Oil & gas
Renewable energy
Transportation

Key Products

Check valves
Connectors for low pressure fluid conveyance
Deep sea umbilicals
Diagnostic equipment
Hose couplings
Industrial hose
Mooring systems & power cables
PTFE hose & tubing
Quick couplings
Rubber & thermoplastic hose
Tube fittings & adapters
Tubing & plastic fittings



Hydraulics

Key Markets

Aerial lift
Agriculture
Alternative energy
Construction machinery
Forestry
Industrial machinery
Machine tools
Marine
Material handling
Mining
Oil & gas
Power generation
Refuse vehicles
Renewable energy
Truck hydraulics
Turf equipment

Key Products

Accumulators
Cartridge valves
Electrohydraulic actuators
Human machine interfaces
Hybrid drives
Hydraulic cylinders
Hydraulic motors & pumps
Hydraulic systems
Hydraulic valves & controls
Hydrostatic steering
Integrated hydraulic circuits
Power take-offs
Power units
Rotary actuators
Sensors



Instrumentation

Key Markets

Alternative fuels
Biopharmaceuticals
Chemical & refining
Food & beverage
Marine & shipbuilding
Medical & dental
Microelectronics
Nuclear Power
Offshore oil exploration
Oil & gas
Pharmaceuticals
Power generation
Pulp & paper
Steel
Water/wastewater

Key Products

Analytical Instruments
Analytical sample conditioning products & systems
Chemical injection fittings & valves
Fluoropolymer chemical delivery fittings, valves & pumps
High purity gas delivery fittings, valves, regulators & digital flow controllers
Industrial mass flow meters/controllers
Permanent no-weld tube fittings
Precision industrial regulators & flow controllers
Process control double block & bleeds
Process control fittings, valves, regulators & manifold valves



Seal

Key Markets

Aerospace
Chemical processing
Consumer
Fluid power
General industrial
Information technology
Life sciences
Microelectronics
Military
Oil & gas
Power generation
Renewable energy
Telecommunications
Transportation

Key Products

Dynamic seals
Elastomeric o-rings
Electro-medical instrument design & assembly
EMI shielding
Extruded & precision-cut, fabricated elastomeric seals
High temperature metal seals
Homogeneous & inserted elastomeric shapes
Medical device fabrication & assembly
Metal & plastic retained composite seals
Shielded optical windows
Silicone tubing & extrusions
Thermal management
Vibration dampening



ENGINEERING YOUR SUCCESS.

www.comoso.com

Parker Fluid Connectors Group

North American Divisions & Distribution Service Centers

Your complete source for quality tube fittings, hose & hose fittings, brass & composite fittings, quick-disconnect couplings, valves and assembly tools, locally available from a worldwide network of authorized distributors.

Fittings:

Available in inch and metric sizes covering SAE, BSP, DIN, GAZ, JIS and ISO thread configurations, manufactured from steel, stainless steel, brass, aluminum, nylon and thermoplastic.

Hose, Tubing and Bundles:

Available in a wide variety of sizes and materials including rubber, wire-reinforced, thermoplastic, hybrid and custom compounds.

Worldwide Availability:

Parker operates Fluid Connectors manufacturing locations and sales offices throughout North America, South America, Europe and Asia-Pacific.

For information, call toll free...

**1-800-C-PARKER
(1-800-272-7537)**

North American Divisions

Fluid System Connectors Division

Otsego, MI
phone 269 694 9411
fax 269 694 4614

Hose Products Division

Wickliffe, OH
phone 440 943 5700
fax 440 943 3129

Industrial Hose Division

Wickliffe, OH
phone 440 833 2120
fax 440 833 2230

Parflex Division

Ravenna, OH
phone 330 296 2871
fax 330 296 8433

Quick Coupling Division

Minneapolis, MN
phone 763 544 7781
fax 763 544 3418

Tube Fittings Division

Columbus, OH
phone 614 279 7070
fax 614 279 7685

Distribution Service Centers

Buena Park, CA

phone 714 522 8840
fax 714 994 1183

Conyers, GA

phone 770 929 0330
fax 770 929 0230

Louisville, KY

phone 502 937 1322
fax 502 937 4180

Portland, OR

phone 503 283 1020
fax 503 283 2201

Toledo, OH

phone 419 878 7000
fax 419 878 7001
fax 419 878 7420
(FCG Kit Operations)

Canada

Grimsby, ONT

phone 905 945 2274
fax 905 945 3945
(Contact Grimsby for other Service Center locations.)

