

Products Overview

Destaco Products "At A Glance"



destaco.com



Focusing all of our Resources

New Product Development

Destaco has dedicated resources to design and build the next generation of products and solutions

Customer and Technical Service

Destaco has industry leading global support to address any product and application concerns you may have

Design Tools

Destaco provides an extensive CAD library, sizing software, and online tools to support our global customers



Our Insight Working for You

Application Engineering

We utilize our expertise and complete portfolio of products to create solutions that fit our customers' needs and applications

Custom Solutions

If our off-the-shelf solutions don't fit, we will partner with our customers to develop products that will



When an off-the-shelf product can't handle it - we can!

With many years of experience working with OEM machine builders, we can make our product fit your unique application. We will partner with you to design the right product for your application – from altering an existing product to building a completely new product, we have the experience and expertise to help your project succeed.

Using our expertise to develop custom solutions for unique applications, Destaco helps you save time and resources, allowing you to focus on your core business and gain a competitive advantage in the marketplace.

- Proven quality from the experts
- Reduce risk by using our experienced engineers
- Easy reordering with unique part numbers
- Simplify your supply chain
- Three levels of customization from simple alterations to complex custom products



AUTOMATION PRODUCTS - ROBOHAND GRIPPERS, ROTARIES AND SLIDES

OEM Products



Electric Parallel Grippers



Parallel Grippers

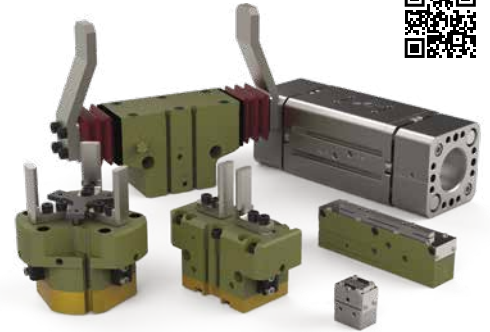

Angular Grippers



Special Grippers



ROBOHAND

Rotary Actuators



Linear Slides



Feed Escapements



CENTRAL RESEARCH LABORATORIES

Fixed Gloveport Systems



Push-Through Gloveport Systems



CRL

Rapid Transfer Ports
(Alpha & Beta Solutions)



AUTOMATION PRODUCTS - CAMCO SERVO AND MECHANICAL POSITIONERS

Servo Positioner Rotary Tables



Mechanical Dial Drives



Mechanical Index Drives

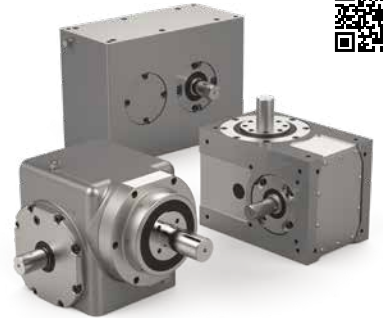

Ring Drive Dial Indexer



Part Handlers



CAMCO

Conveyor Systems



Overload Clutches



Custom Cams



- REMOTE HANDLING AND CONTAINMENT SOLUTIONS

One-Piece Manipulators



Three-Piece Manipulators



CRL

Waste & Bulk Packaging Solutions



For more information, please contact us at solutions@destaco.com

www.mfcp.com www.comoso.com

MANUAL AND PNEUMATIC POWER CLAMPS

Vertical Hold Down Clamps



100+ Models Available



Horizontal Hold Down Clamps



70+ Models Available



Push Action Clamps



70+ Models Available



Squeeze Action Plier Clamps

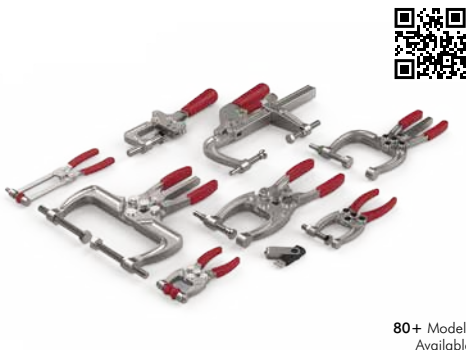

80+ Models Available



Pull Action Latch Clamps



50+ Models Available



Pneumatic Toggle Clamps



30+ Models Available



Pneumatic Swing Clamps

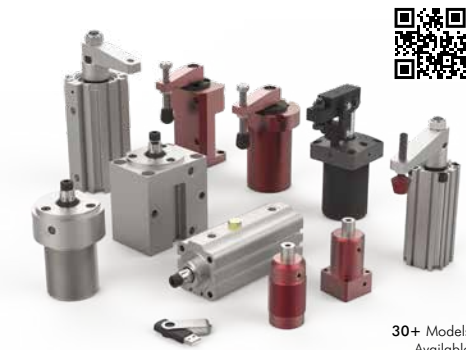

30+ Models Available



Pneumatic Power Cylinders



70+ Models Available



Pneumatic Round Power Clamps



8 Models Available



Pneumatic Power Clamps

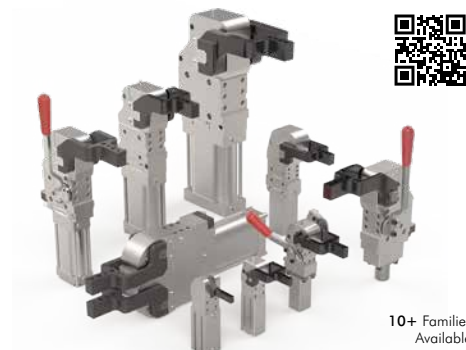

10+ Families Available



Tolerance Compensating Power Clamps



Pin Clamps & Packages, Pivot Units

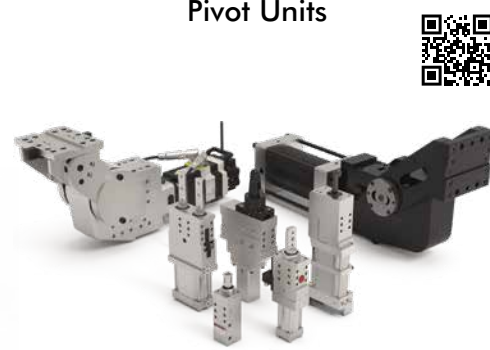

Product offering and availability is subject to change without notice

www.mfcp.com www.comoso.com

END EFFECTOR SOLUTIONS

Accelerate® Lightweight Tooling



World Tool & Round Tooling Systems



Tool Changers & Compliance Devices



Lower Tooling Components



BodyBuilder™ Tooling System



SpiderGrip™ Tooling System



Vacuum Cups & Products



ARV® Auto Release Venturi Vacuum Generators



Destacker Products



Accelerate® Press Room Grippers



Sheet Metal Grippers



Bag Grippers

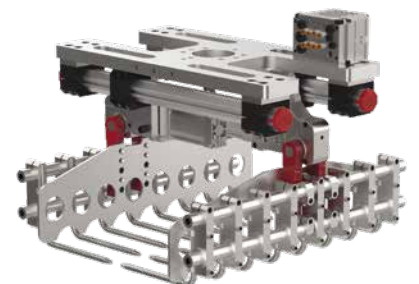



ROBOHAND

Grippers, Rotaries, and Linear Slide Solutions

Engineered Reliability

Destaco's Robohand products are engineered for reliability and long life to ensure maximum production uptime. These products are designed and machined for precise repeatability with minimal maintenance.



CAMCO

Rotary Indexers and Conveyor Solutions

Smarter Precision Indexing

Destaco's CAMCO products have been the industry standard for the highest quality cam-actuated motion control products available. Destaco manufactures a wide range of motion control products including indexing drives, linear and rotary parts handlers, precision link conveyors, magnetically-propelled conveyors, servo-mechanical drives, and custom cams.



Manual and Pneumatic Clamping Solutions

Designed to Hold Securely

Destaco manual and pneumatic light-duty clamps are built to last for years of service, and designed to keep your workpieces in place. Manual and light-duty clamps are offered in a wide variety of styles to hold a part securely in place during an application.

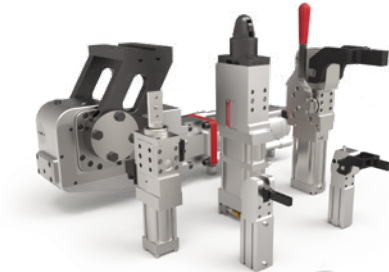

Power Clamping and Pivot Solutions

Clamp with Confidence

Destaco power clamping products range from heavy-duty sealed clamps for welding environments, to compact light-duty clamps for a variety of clamping applications. Pin clamps and pivot units are used in locating and positioning applications. All of these products offer exceptional clamping forces, holding capacities, and durability.



End Effector Solutions

Speed Matters

Destaco end effectors are designed to help you move parts faster in today's production line by using high strength, lightweight aluminum modular components, durable vacuum cups and the fastest venturis on the market.

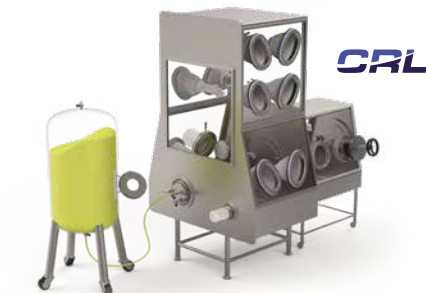

CRL

Remote Handling and Containment Solutions

Clean. Safe. Flexible.

Destaco's Central Research Laboratories (CRL) rapid transfer ports, gloveport systems and telemanipulators allow human operators to safely perform dexterous maneuvers in hazardous or sterile environments. Destaco's CRL products are designed for safe and efficient handling of materials where the human operator cannot have direct contact.



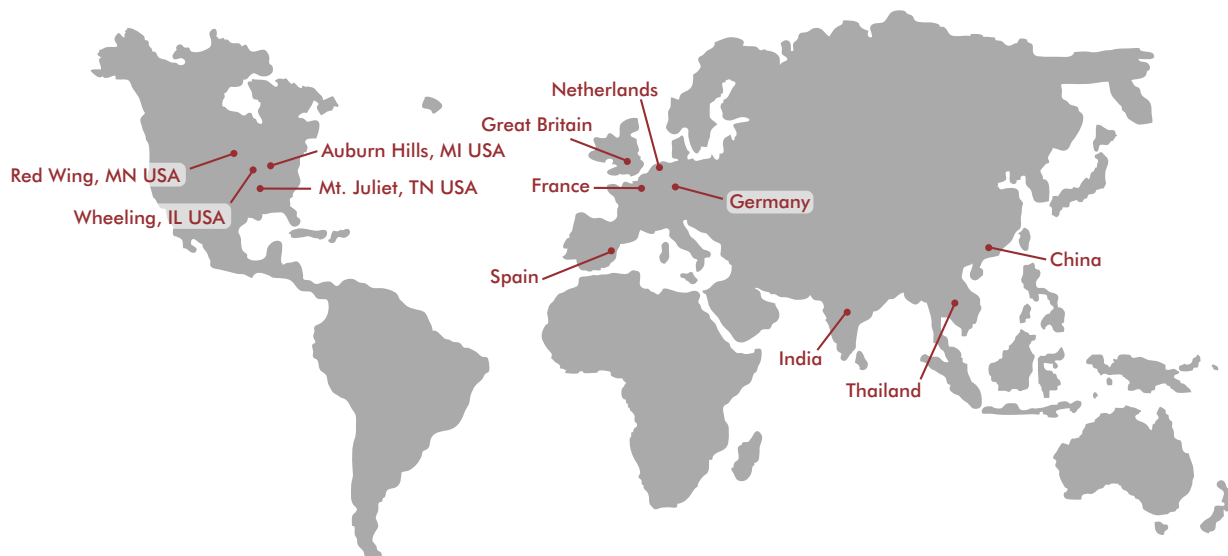

GLOBAL LOCATIONS

NORTH AMERICA

Corporate Headquarters

Auburn Hills, Michigan
Toll Free: 1.888.DESTACO
Marketing: marketing@destaco.com

Global Technology Center

Auburn Hills, Michigan
Tel: 1.248.836.6700
Customer Service: customerservice@destaco.com

Mt. Juliet, Tennessee
Tel: 1.888.DESTACO
Customer Service: customerservice@destaco.com

Wheeling, Illinois
Tel: 1.800.645.5207
Customer Service: camco@destaco.com

Red Wing, Minnesota (Central Research Laboratories)
Tel: 651.385.2142
Customer Service: sales@centres.com

ASIA

Thailand
Tel: +66-2-326-0812
Customer Service: info@destaco.com

China
Tel: +86-21-6081-2888
Customer Service: china@destaco.com

India
Tel: +91-80-41123421-426
Customer Service: india@destaco.com

EUROPE

Germany
Tel: +49-6171-705-0
Customer Service: europe@destaco.com

France
Tel: +33-4-73545001
Customer Service: france@destaco.com

Great Britain
Tel: +44-1902-797980
Customer Service: uk@destaco.com

Spain
Tel: +34-936361680
Customer Service: spain@destaco.com

Netherlands
Tel: +31-297285332
Customer Service: benelux@destaco.com

CLICK OR SCAN

for the latest
PDF version of
this document.

