

INDEXING SOLUTIONS

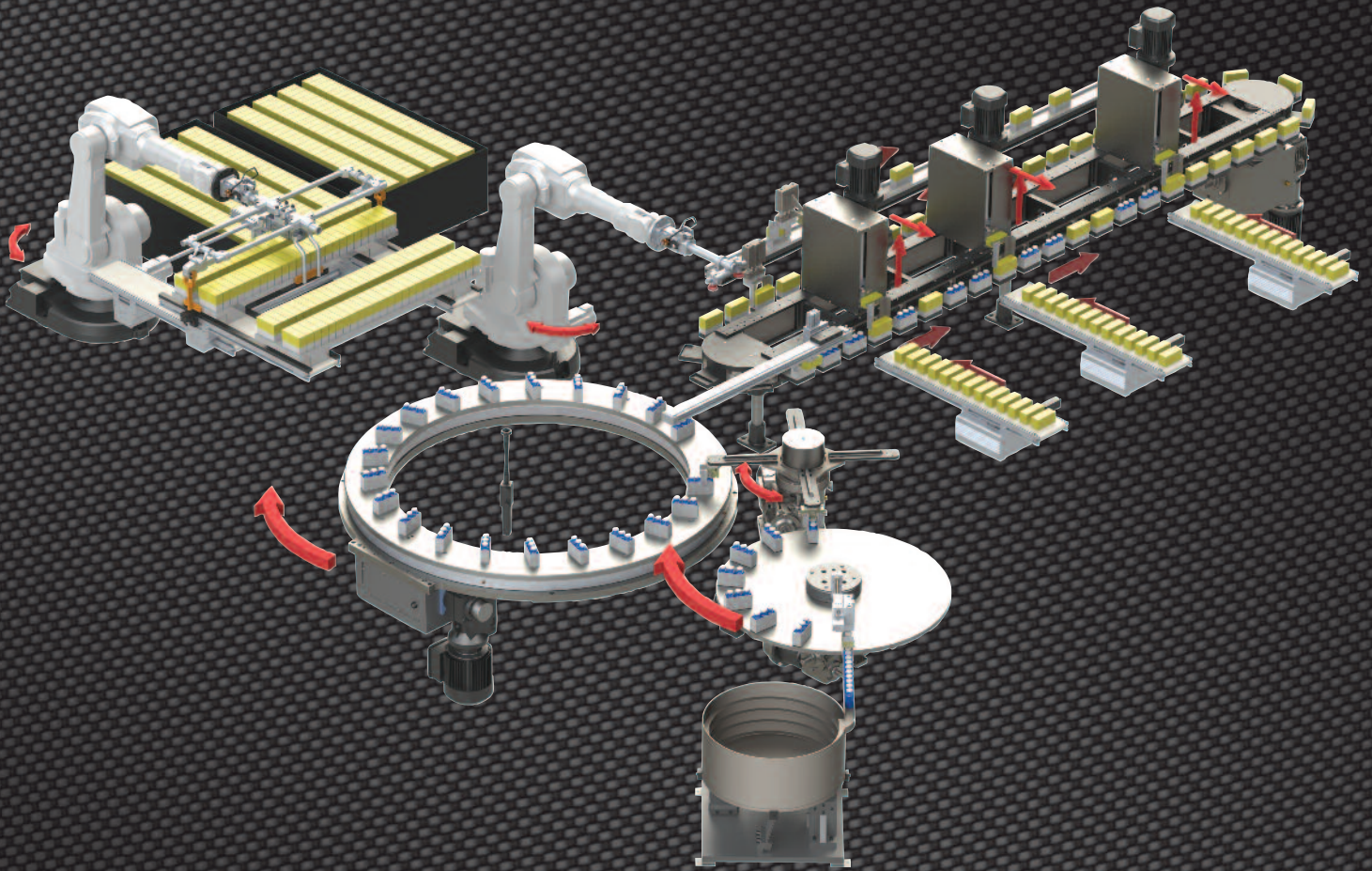

CAMCO

Automation Application Guide



THE BEST PRODUCTS. UNMATCHED SERVICE. WORLDWIDE.

With a support network spanning the globe, DE-STA-CO offers consistent, comprehensive service to any location in the world. Whether your operations are localized or span multiple continents, you will always have access to the highest levels of customer service and technical support.

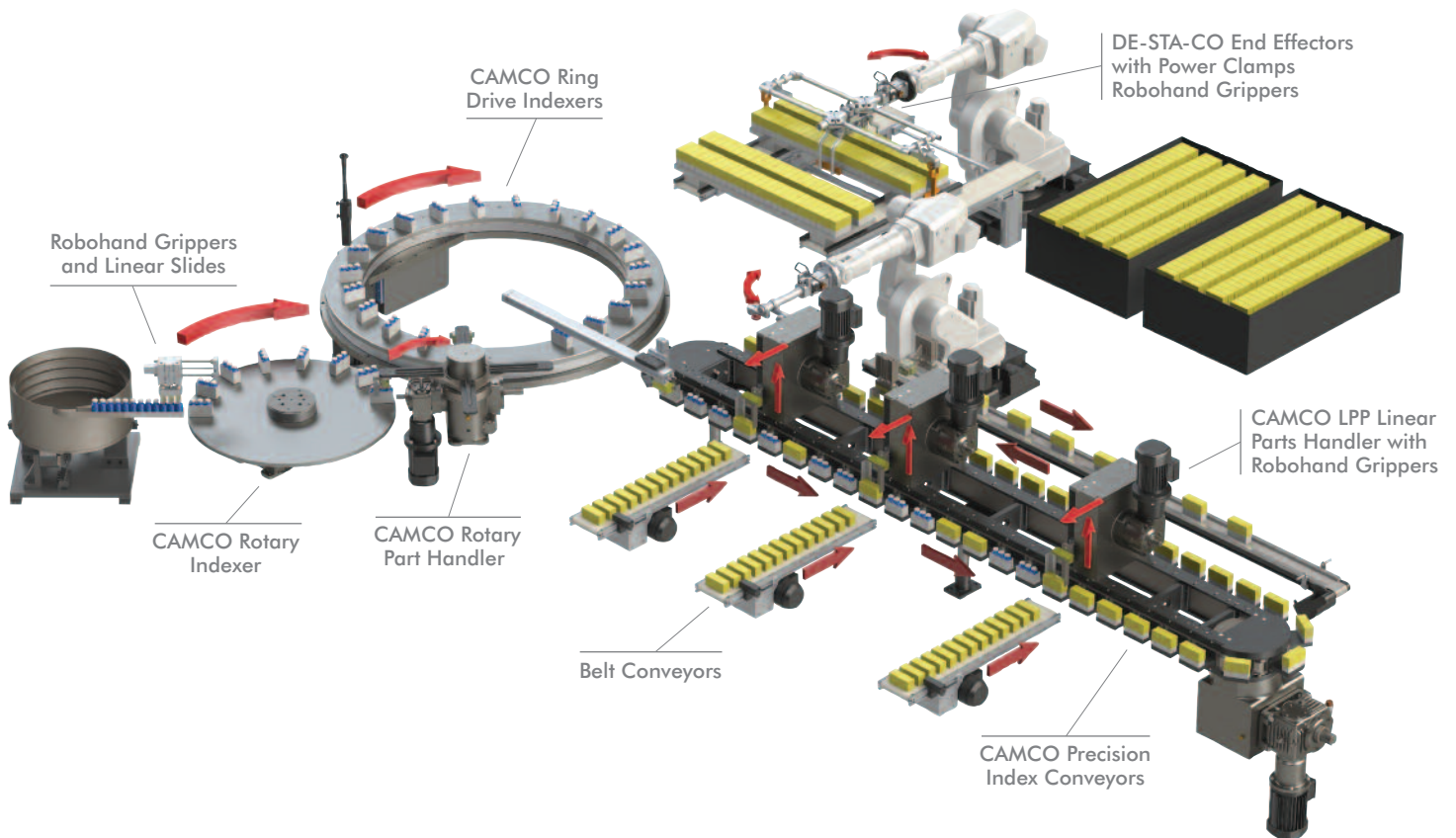

For more than 50 years, CAMCO global products have been the industry standard for the highest quality cam-actuated motion control products available. DE-STA-CO manufactures a wide range of motion control products including:

- Indexing Drives (index tables) with right angle or parallel shaft orientation, shaft or flange (dial) outputs, ranging from the larger E-Series Index Drives, which can rotate several tons of automotive body parts in seconds to smaller Parallel and Roller Gear RDM family of Index Drives which can accurately index pharmaceutical or electronic components.
- Precision Link Conveyors provide precision positioning for linear transfer applications in modular table top and heavy-duty sizes, in either over-under or carousel configurations. For the lighter duty applications, CAMCO offers the Rite-Link Conveyor, a new innovative conveyor concept designed for either industrial or medical applications. Combine with CAMCO Rotary or Linear Parts Handlers for a complete parts handling system.
- 115RSD Servo-Mechanical Drives provide zero-backlash speed reduction combined with a large flanged output and through hole for use with industry standard servo motors.

DE-STA-CO, with Camco and Robohand products, can now supply you with a complete standard or custom automation solution; indexers, oscillators, conveyors, grippers and slides.



RDM - Dial Indexer



115RSD - Flexible Dial Indexer



RGS - Shaft Indexer

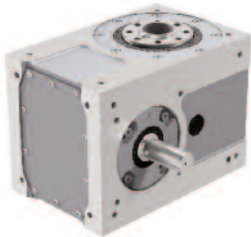

RGD - Flange Indexer



Rite-Link Conveyor

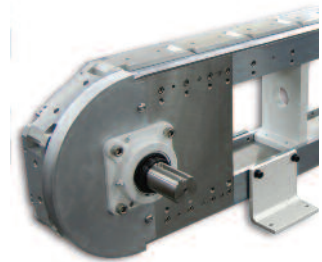
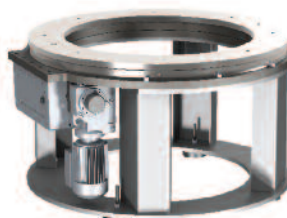

Table Top Modular Conveyor



Parallel Shaft/Flange Indexer



RNG - Easy Access Indexer

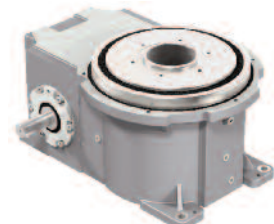

RD - Heavy Duty Dial Indexer

Fixed and Flexible Dials, Conveyors and Parts Handlers

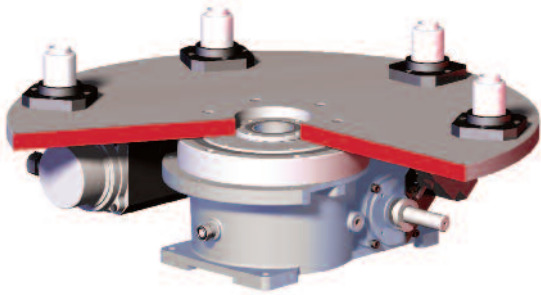

RDM Indexer with dial and fixed number of stations

- Operation is asynchronous (cycle on demand) – a single index followed by a variable dwell time.
- Index motion time is changed by adjusting the frequency setting of the inverter drive.
- Dwell time is variable.
- 30 cycles per minute with a DC motor and drive and 60 cycles per minute with an AC motor and drive.



115RSD Flexible Indexer with a dial

- Servo Driven Indexer with dial and variable number of stations
- Operation is asynchronous (cycle on demand) – a single index followed by a variable dwell time.
- Index motion time is changed by changing the motion profile of the servo motor.
- Dwell time is variable. Single axis servo or multiple axis servo controllers can be used.
- More than 60 cycles per minute – maximum cycle rate can be determined by your application engineer.

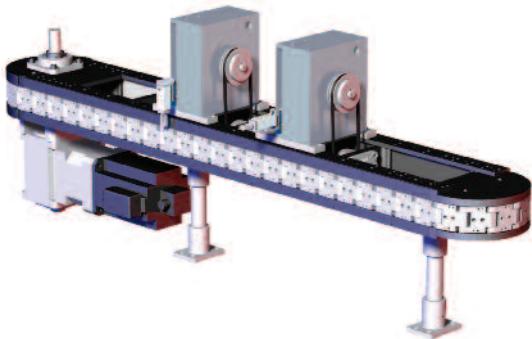

Indexer driving a conveyor and Linear Part Handlers

- Operation can be asynchronous (cycle on demand) – a single index followed by a variable dwell time, or the operation can be continuous.
- Index motion time is changed by changing the motion profile of the servo motor.
- Dwell time is variable. Single axis servo or multiple axis servo controllers can be used.
- More than 60 cycles per minute – maximum cycle rate can be determined by your application engineer.



CAMCO Cambot Parts Handlers with Robohand Electric Gripper

- CAMCO Cambot LPP Pick and Place mounted to conveyor chassis can be supplied with DE-STA-CO Robohand grippers and can be used to load and unload product. Rotary Pick and Place units are also available.
- All motion axes and grippers can be sequenced by your PLC.

Flexible Multi-Axis and High Speed



Flexible Cambot Pick and Place

The main rotary axis of the Flexible Cambot Pick and Place is a servo driven indexer. The indexer is used because it has a large output flange face with a large bearing. The linear axis is a Robohand slide. Spidergrip or BodyBuilder components can be connected to Robohand grippers or DE-STA-CO vacuum products to make complete custom end effector solutions.

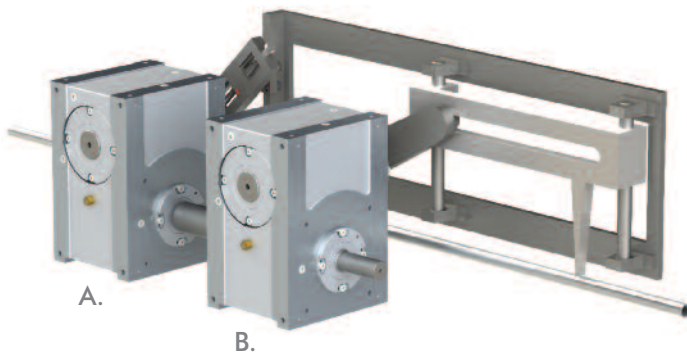

Flying Cutoff Application

This application takes a formed tube and cuts it to length. The inputs of two CAMCO roller gear models are coupled together and work together to produce the product. A slaved servo motor is used to drive the two CAMCO boxes and will stay in step with any possible speed variations of the tube line. The model on the left (A) is an indexer that has an adjustable length arm that moves a frame holding the cutting tool. The indexer moves the frame to match the speed and position. The model on the right (B) is an oscillator that moves the cutting tool down and up. The length of the tube is infinitely adjustable. Longer pieces are cut by increasing the arm length. Very long pieces are cut by allowing the tube to flow out before the servo motor is single cycled.

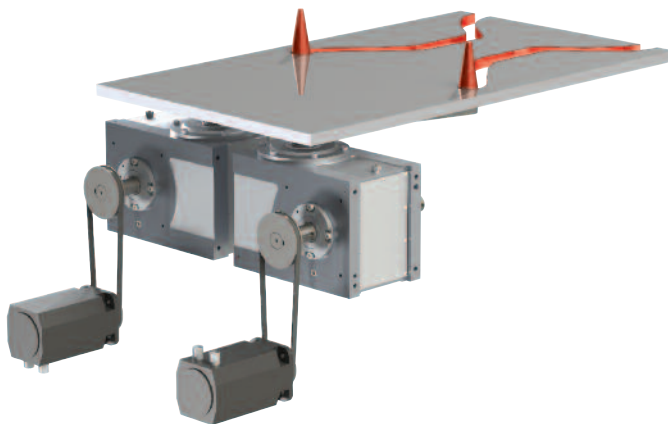

High Speed Contouring

This application requires high speed contouring (>1000 ppm) of a paper or plastic web. Two CAMCO oscillators have lasers or similar cutting tools mounted to the ends of the oscillating arms attached to them. In this example, the customer submitted desired patterns for the finished product and CAMCO engineers designed cams that closely met the customer patterns, were dynamically stable and did not require maintenance. The two servos that drive the cam boxes are slaved to the web line and will stay in step with it.



RDM Roller Dial Index Drives

The RDM Series Index Drive is ideal for rotary dial applications with features including:

- Low profile
- Large center thru hole
- Large output mounting surface supported by 4-point contact bearing, offering superior thrust and moment capacity
- Complete motorized drive packages and option overload clutch

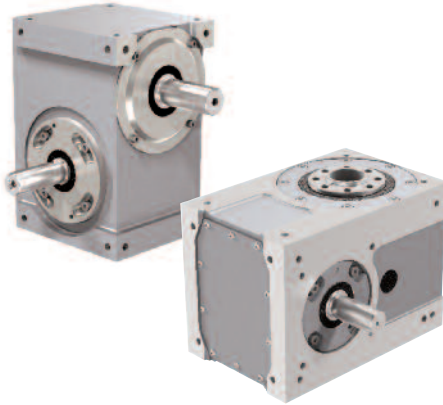

RGD/RGS Roller Gear Index Drives

Roller Gear Index Drives are robust, versatile units suitable for a wide variety of applications. Roller Gear Index Drives feature:

- Universal mounting with mounting holes on all six sides
- Flange or shaft output
- Center thru hole (flange version)
- Custom motions such as oscillating motions, or short index periods, available



RD & Intermittor Roller Dial Index Drives

Roller Dial Index Drives offer superior load capabilities, making them ideal for medium to high torque applications.

Other features include:

- Universal mounting, including horizontal mounting, ideal for trunion applications
- Center thru hole facilitates passage of electrical wiring, pneumatic lines or mechanical linkages
- Short camshaft motion periods are well-suited to continuous running applications or for special motion requirements
- Available with custom motions such as oscillating motions

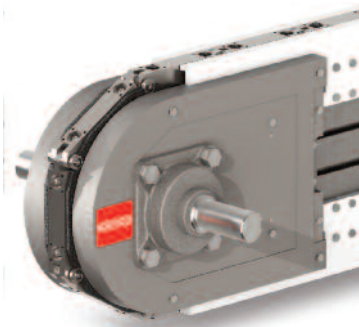

Rite-Link Conveyor

The CAMCO Rite-Link Conveyor is a thin profile, preassembled, precision link system that offers maintenance free accuracy and durability for industrial conveying applications.

Other features include:

- Fully designed, assembled and tested for your application
- Slim, compact design with narrow link accommodates oversized tooling
- More accurate and stable than roller chain with high operating speed capabilities
- Servo-friendly for flexible indexing with CAMCO RSD rotary servo drive



RSD Rotary Servo Drive

SMARTER INDEXING: The CAMCO RSD Rotary Servo Drive is a zero-backlash, cam-actuated drive compatible with industry-standard servo motors for precise control, efficiency and flexibility.

Other features include:

- Designed to accept a variety of servo motors
- Preloaded for zero backlash, high accuracy, and smooth motion
- Indexing flexibility
- 4:1 to 18:1 ratio in single state



Parallel Index Drives

Parallel Index Drives are ideal for high-speed applications or for actuation-type applications such as driving a linkage or a conveyor.

Other features include:

- High-speed and high-load capability
- Whole or fractional stops, oscillating and complex custom motions are available
- Long transfer distances achieved with simple linkages
- Rigid and backlash free operation

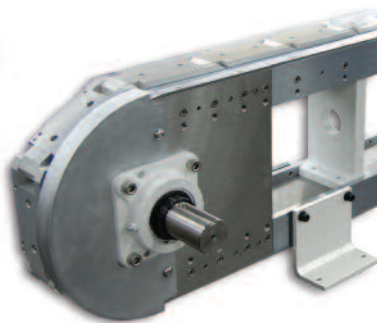

Precision Link Conveyor Modular Table Top

Precision link conveyors provide designers and engineers with a multiple-station chassis for the assembly of more complicated products. Lengths from 3 feet to 40 feet, with link pitch of 3, 4.5 or 6 inches, are available to suit any requirement.

Other features include:

- Modular frame design in 18" increments for quick assembly and delivery
- Precision positioning of parts
- Open frame design for pass through of belting, linkages, and electric and air supply components
- Metric links also available, upon request

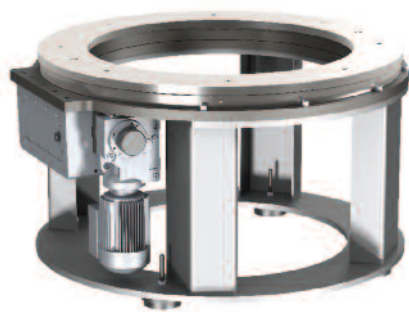

RNG Ring Index Drives

Ring Index Drives have a large center opening ideal for mounting auxiliary equipment within the center space, freeing floor space and providing operator access. The Ring Drive is ideally suited for pad printing and decorating equipment and for automatic assembly machinery applications that require a large number of workstations.

Other features include:

- Up to 60 station capability, ideal for multiple part automatic assembly machines
- Sealed 4-point contact output bearing for superior accuracy and load capability
- Modular shaft-mounted reducers for application flexibility and easy maintenance



A DOVER COMPANY

Workholding

- Widest variety of workholding products
- High durability and reliability
- Flexible solutions for all applications
- Custom products for unique requirements

Automation

- Broad range of engineered automation products
- Complementary products for modular integration
- Unmatched accuracy, reliability and performance
- Unparalleled global sales, service and engineering support

GLOBAL LOCATIONS

NORTH AMERICA

DE-STA-CO Headquarters
 Auburn Hills, Michigan
 Tel: 1.248.836.6700
 Toll Free: 1.888.DESTACO
 Marketing: marketing@destaco.com
 Customer Service: customerservice@destaco.com

Charlevoix, Michigan
 Tel: 1.888.DESTACO
 Customer Service: customerservice@destaco.com

Wheeling, Illinois
 Tel: 1.800.645.5207
 Customer Service: camco@destaco.com

Red Wing, Minnesota (Central Research Laboratories)
 Tel: 651.385.2142
 Customer Service: sales@centres.com

SOUTH AMERICA

Brazil
 Tel: 0800-124070
 Customer Service: samerica@destaco.com

ASIA

Thailand
 Tel: +66-2-326-0812
 Customer Service: info@destaco.com

China
 Tel: +86-21-6081-2888
 Customer Service: china@destaco.com

India
 Tel: +91-80-41123421-426
 Customer Service: india@destaco.com

EUROPE

Germany
 Tel: +49-6171-705-0
 Customer Service: europa@destaco.com

France
 Tel: +33-1-3996-5000
 Customer Service: france@destaco.com

UK
 Tel: +44-1902-797980
 Customer Service: uk@destaco.com

Spain
 Tel: +34-936361680
 Customer Service: spain@destaco.com

Netherlands
 Tel: +31-297285332
 Customer Service: benelux@destaco.com



A DOVER COMPANY

CAMCO Products

1444 South Wolf Road
 Wheeling, IL 60090
 phone: 1.847.494.5200
 fax: 1.847.459.3064

Email: camco@destaco.com
 Web: www.destaco.com

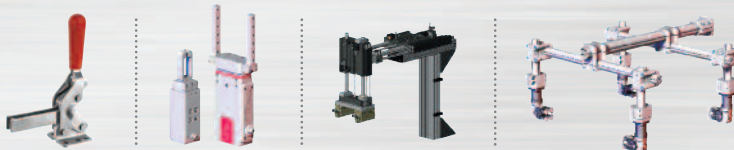

© Copyright, 2011 DE-STA-CO. All rights for layout, photos and text rest with the publisher DE-STA-CO. All photomechanical or other reproductions only with our express permission. All sales are based on our terms and conditions of sale, delivery and payment.

DSC_CAG-B_0711_US_XXK SOTAD